

RUDOLF

BECAUSE WE CARE

The word "ENT" is written in a bold, white, sans-serif font. It is positioned to the right of a vertical stack of five inset images showing various ENT surgical instruments. The background of the entire advertisement is a large, close-up image of a pair of ENT forceps, rendered in a dark, metallic green color with a brushed metal texture.

serving healthcare worldwide



ENT

Mit Blick in die Zukunft

RUDOLF Medical GmbH + Co. KG wurde als Firma 1950 gegründet. Heute ist bereits die dritte Rudolf-Generation an der Leitung des Unternehmens und **RUDOLF** Medical zählt weltweit zu den führenden Herstellern von chirurgischen Instrumenten und Geräten.

Focused on the Future

***RUDOLF** Medical GmbH + Co. KG was established as a company in 1950. Today the 3rd Rudolf generation is at the steering wheel of the company and **RUDOLF** Medical ranks among the leading manufacturers of surgical instruments and equipment worldwide.*



Handarbeit und Hightech

Das Geheimnis der Herstellung der **RUDOLF** Medical Produkte liegt einerseits in der Verwendung hochwertiger Werkstoffe andererseits in der harmonischen Verschmelzung von langjähriger Handwerkskunst, speziellen Herstellungsverfahren und neuesten Technologien.

Die Automatisierung spielt eine wichtige Rolle in der Fertigung der Firma **RUDOLF** Medical. Wann immer möglich, ersetzen CNC-Roboter die Handarbeit, um während des Herstellungsprozesses hohe Präzision und immer gleich bleibende Instrumentenmodelle zu gewährleisten. Am Ende ist es jedoch immer noch die Hand des Meisters, die den Instrumenten den letzten Schliff verleiht.

Handicraft and High Tech

***RUDOLF** Medical products prove that the secret of manufacturing high quality instruments lies in the employment of exquisite materials as well as in the perfect merging of long handicraft experience, special manufacturing techniques and state-of-the-art technologies.*

*Automation plays a main role in **RUDOLF** Medical's production. Whenever it is possible CNC robots replace handicraft to ensure high precision during the manufacturing process and to guarantee instrument pattern consistency. Nevertheless it is still the master craftsman's hand that gives the instruments the final, "human" touch.*

Feedback der Endkunden

Die Weiterentwicklung der Medizintechnik ist nur möglich mittels des kontinuierlichen Dialogs mit den Anwendern; sie setzen die Produkte der Medizintechnik täglich ein und können somit die Instrumente und Geräte am besten beurteilen. Ihr Feedback ist daher für die Medizintechnik von unschätzbarem Wert und führt zur Weiterentwicklung und Herstellung innovativer Produkte.

Die enge Zusammenarbeit zwischen führenden Chirurgen weltweit und **RUDOLF** Medical ist für alle Beteiligten von großem Vorteil. Der Fortschritt der Medizintechnik schafft neue Voraussetzungen und eröffnet somit neue Perspektiven für die Chirurgie.

End-Users' Feedback

The continuous development of medical technology is only possible through a sustained dialogue with the surgeons; they use the tools offered by the medical device industry daily and therefore they can evaluate the instruments and equipment best. Their feedback is extremely valuable resulting finally in enhanced and innovative products.

*This close co-operation between leading surgeons worldwide and **RUDOLF** Medical is mutually beneficial: the progress of the medical technology leads to new possibilities and opens up new vistas in surgery.*

Forschung und Entwicklung

RUDOLF Medical hat die großen und schnellen Fortschritte in der Medizin schon immer als Herausforderung betrachtet.

Die Ingenieure setzen mit Ihrem technischen Know-how die Ideen und die Erfahrung der Anwender um; so entstehen neue und einzigartige Produkte, welche durch innovative Lösungen, Präzision, Funktionalität und Haltbarkeit überzeugen.

Research and Development

***RUDOLF** Medical has always considered the major and rapid progress of medicine as a challenge. The engineers with their technical know-how put into practice the ideas and experience of the end-users and create thus new and unique products which are absolutely convincing in terms of precision, functionality and durability.*

Serving Healthcare Worldwide

Eine kontinuierliche Weiterbildung wird durch die immer schneller fortschreitende Entwicklung in allen Bereichen der Medizin unerlässlich; dies gilt für alle, die im Gesundheitswesen oder in der Medizintechnikbranche tätig sind.

RUDOLF Medical organisiert weltweit Workshops, in denen Chirurgen Erfahrung mit neuen OP-Techniken und neuen chirurgischen Instrumenten und Geräten sammeln können.

Nur gut vorbereitete und geschulte Vertriebspartner können die Anforderungen und Wünsche der Chirurgen richtig verstehen und die erhaltenen Informationen an die Entwicklungs- und Forschungsabteilung korrekt weitergeben. **RUDOLF** Medical unterstützt daher ihre Vertriebspartner in über 80 Ländern mit regelmäßigen Produktschulungen und Kursen über neue OP-Techniken und den Einsatz der spezifischen Instrumente und Geräte.

Somit leistet **RUDOLF** Medical einen indirekten Beitrag zum Fortschritt der Chirurgie.

Serving Healthcare Worldwide

The accelerated development of all medical fields makes continuous study indispensable. This is valid for everybody employed in the healthcare sector or in the medical technology industry.

***RUDOLF** Medical organizes workshops which help surgeons gather experience with new operation techniques and the use of specific surgical instruments and equipment.*

*Only well trained sales representatives can understand the needs of the surgeons and thus forward correctly the received information to the Research & Development Department. **RUDOLF** Medical assists all its representatives in over 80 countries through regularly held product trainings and courses on operation techniques with special accent on the use of the specific instruments and equipment.*

*This way **RUDOLF** Medical contributes indirectly to the progress of surgery.*

Breite Produktpalette

Die **RUDOLF** Medical Produktpalette umfasst alles, was die heutige Chirurgie erfordert: vom Basisinstrumentarium für die offene Chirurgie bis zu der neuesten Generation der HD 3CCD digitalen Kameras.

RUDOLF Medical GmbH + Co. KG, weltweit vertreten, vertraut auf bleibende Werte und setzt diese durch enge Kundenbeziehungen um, **RUDOLF** Medical bietet innovative Hightech-Produkte, Handinstrumente, starre Endoskope sowie effiziente Serviceleistungen für zahlreiche chirurgische Fachgebiete an.

ALLGEMEINCHIRURGIE | THORAXCHIRURGIE | HERZ- UND GEFÄSSCHIRURGIE | KOPF- UND HALSCHIRURGIE |
SCHÄDELBASIS-CHIRURGIE | NEUROCHIRURGIE | ORTHOPÄDIE | SPORTMEDIZIN | LAPAROSKOPIE |
GYNÄKOLOGIE | UROLOGIE | ZSVA-ZUBEHÖR

Wide Product Range

***RUDOLF** Medical product range covers all that today's surgery requires: starting from the basic instrument sets for open surgery up to the latest generation of HD 3CCD Digital Cameras.*

***RUDOLF** Medical GmbH + Co. KG, represented worldwide, translates its belief in lasting values by fostering close customer relationships and offering innovative high technology products, hand instruments, rigid endoscopes as well as efficient services for numerous surgical disciplines:*

GENERAL SURGERY | THORAX SURGERY | CARDIOVASCULAR SURGERY | HEAD & NECK SURGERY |
SKULL BASE SURGERY | NEUROSURGERY | ORTHOPAEDICS | SPORTS MEDICINE | LAPAROSCOPY |
GYNAECOLOGY | UROLOGY | CSSD ACCESSORIES

Haupt- und Sonderkataloge

Unser breites Produktsortiment für HNO finden Sie in diesem Katalog. Für viele Fachbereiche, sowohl der offenen als auch der minimal invasiven Chirurgie, stehen weitere Kataloge zur Verfügung.

Alle aktuellen **RUDOLF** Medical Kataloge stellen wir auf unserer Webseite vor:
www.rudolf-med.com

General and Special Catalogues

This catalogue presents our wide product range for ENT.

Special catalogues are available for many fields of both Open and Minimally Invasive Surgery.

*We present all current **RUDOLF** Medical Catalogues on our homepage:*
www.rudolf-med.com

Urheberrecht, Warenzeichen und Patente

Die Informationen, Texte, Abbildungen, Logos und Warenzeichen sowie alle **RUDOLF** Medical Patente in diesem Katalog sind geistiges Eigentum der Firma **RUDOLF** Medical GmbH + Co. KG und somit rechtlich geschützt. Sie dürfen nicht an Dritte weitergegeben, in irgend einer Form vervielfältigt oder verändert werden ohne die vorherige, ausdrückliche und schriftliche Genehmigung der Firma **RUDOLF** Medical GmbH + Co. KG.

Haftung

Für den Inhalt dieses Katalogs ist **RUDOLF** Medical GmbH + Co. KG verantwortlich. Obwohl die Inhalte dieses Katalogs eingehend geprüft wurden, garantiert **RUDOLF** Medical GmbH + Co. KG nicht, dass die enthaltenen Informationen vollkommen fehlerfrei sind.

Abweichungen von den im Katalog dargestellten und beschriebenen Produktmodellen behält sich **RUDOLF** Medical vor, da Änderungen der Produktentwicklung dienen oder aus produktionstechnischen Gründen notwendig sind. **RUDOLF** Medical kann die in diesem Katalog enthaltenen Informationen ohne vorherige Ankündigung ändern.

Gedruckt in Deutschland – 03. 2017

Copyright, Trademarks and Patents

*All information, texts, pictures, graphics, logos and trademarks as well as all **RUDOLF** Medical patents in this catalogue are the intellectual property of **RUDOLF** Medical GmbH + Co. KG and therefore protected by copyright and other protective laws. They may not be made accessible to third parties and may not be duplicated or modified in any way without the explicit and prior written consent of **RUDOLF** Medical + Co. KG.*

Liability Note

***RUDOLF** Medical GmbH + Co. KG is responsible for the content of this catalogue. Although the content of this catalogue has been checked thoroughly, **RUDOLF** Medical GmbH + Co. KG does not guarantee the perfect accuracy of the provided information.*

*The patterns/designs of the products illustrated and described in this catalogue are subject to alterations. Product modifications may be necessary either for product development or production reasons. The information you find in this catalogue may be altered by **RUDOLF** Medical without prior notice.*

Printed in Germany – 03.2017

ÜBERSICHTSTAFEL **GENERAL CONTENT**

Endoskope **Endoscopes**

Seiten/Pages 1–12

Hochfrequenz-Chirurgie **High-Frequency Surgery**

Seiten/Pages 13–38

Allgemeines Instrumentarium **General Surgical Instruments**

Seiten/Pages 39–152

Motorsystem und Bohrer **Motor System and Burrs**

Seiten/Pages 153–160

Otologie und Ohr-Mikrochirurgie **Otology and Ear Microsurgery**

Seiten/Pages 161–242

Rhinologie und Rhinoplastik **Rhinology and Rhinoplasty**

Seiten/Pages 243–318

Adenotomie und Tonsillektomie **Adenoidectomy and Tonsillectomy**

Seiten/Pages 319–346

ÜBERSICHTSTAFEL
GENERAL CONTENT

Sinuskopie
Sinuscopy

Seiten/*Pages* 347–376

Tracheotomie
Tracheotomy

Seiten/*Pages* 377–382

Laryngologie und Endolaryngeale Mikrochirurgie
Laryngology and Endolaryngeal Microsurgery

Seiten/*Pages* 383–412

Bronchoskopie und Oesophagoskopie
Bronchoscopy and Oesophagoscopy

Seiten/*Pages* 413–416

Reinigung, Pflege und Sterilisation
Cleaning, Care and Sterilization

Seiten/*Pages* 417–430

Inhaltsverzeichnis

Seiten/*Pages* 431–442

Index

Seiten/*Pages* 443–454

Nummernverzeichnis
Numerical Index

Seiten/*Pages* 455–472



ENDOSKOPE

ENDOSCOPES

Seiten 1 - 12

Pages 1 - 12

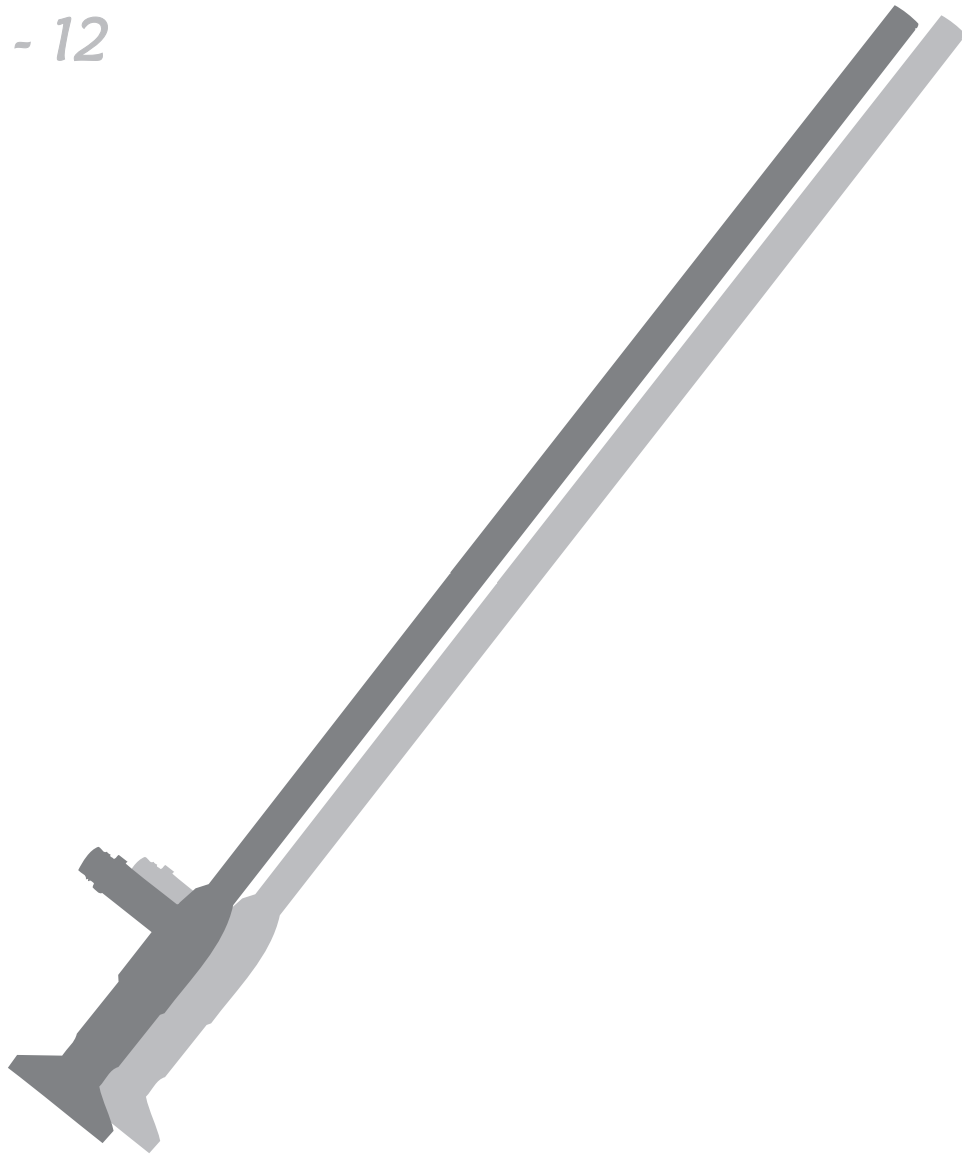

Übersicht

Endoskope, Optische Zangen
Rhino-Pharyngo-Laryngo-Fiberskope
Zangen
Kaltlicht-, HTT-Kabel, Adapter
Handgriffe, Schäfte
Halogen-Lichtgriff

Overview

Endoscopes, optical forceps
Flexible rhino-pharyngo-laryngo-fiberscopes
Forceps
Cold light and HTT cables, fittings
Handles, shafts
Halogen light handle

Seiten / Pages

2-5
6
7
8-9
10
11

**ENDOSKOPE
ENDOSCOPES**

autoklavierbar/autoclavable
max. 134°C, 2,3 bar

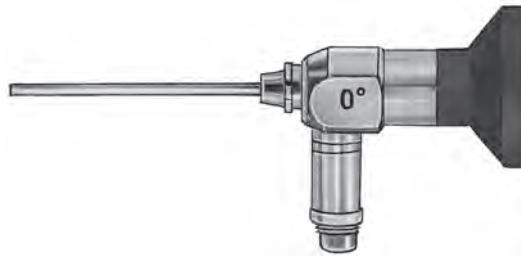

Ø 2,7 mm, 50 mm

EN127-000 0°
EN127-030 30°

Ø 4,0 mm, 50 mm

EN140-100 0°
EN140-130 30°

Otoskop
Otoscope

autoklavierbar/autoclavable
max. 134°C, 2,3 bar

ausgenommen Artikel „**einlegbar**“
except where explicitly indicated „**soakable**“



Ø 10 mm, 180 mm

EN100-070 70°
EN100-090 90°
EN100-170 70°

mit Lichtleiter/integrated light cable

EN100-190 90°

mit Lichtleiter/integrated light cable

EN100-270 70°

1,5 x Lupe mit Lichtleiter, **einlegbar**/1,5 x Magnification, **soakable**

EN100-290 90°

1,5 x Lupe, **einlegbar**/1,5 x Magnification, **soakable**

EN100-370 70°

1,5 x Lupe mit Lichtleiter, **einlegbar**/
1,5 x Magnification integrated light cable, **soakable**

Laryngoskop
Laryngoscope

autoklavierbar/*autoclavable*
max. 134°C, 2,3 bar



Endoskop zur endolaryngealen Mikrochirurgie
Endoscope for endolaryngeal microsurgery

Ø 5 mm, 240 mm

EN150-130 30°
EN150-170 70°

autoklavierbar/*autoclavable*
max. 134°C, 2,3 bar



Ø 2,9 mm, 360 mm

EN129-000 0°
EN129-030 30°

Ø 5,5 mm, 505 mm

EN155-000 0°
EN155-030 30°

Bronchoskop
Bronchoscope

ENDOSKOPE / OPTISCHE ZANGE
ENDOSCOPES / OPTICAL FORCEPS

autoklavierbar/*autoclavable*
max. 134°C, 2,3 bar



Ø 2,7 mm, 175 mm

- EN127-100** 0°
- EN127-130** 30°
- EN127-170** 70°

Ø 2,7 mm, 187,5 mm

- EN127-200** 0°
- EN127-230** 30°
- EN127-270** 70°

Ø 4,0 mm, 175 mm

- EN140-000** 0°
- EN140-030** 30°
- EN140-045** 45°
- EN140-070** 70°

Sinuskop
Sinuscope

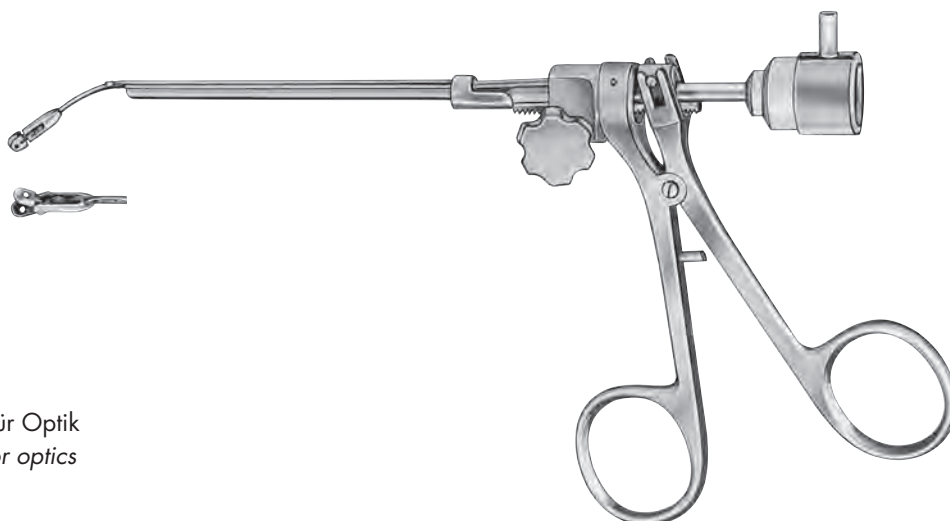

RU 0400-21

Optische Zange für Optik
Optical forceps for optics
EN127-130

autoklavierbar/*autoclavable*
max. 134°C, 2,3 bar



Ø 4,0 mm, 302 mm

EN140-200

0°

EN140-230

30°

EN140-270

70°

Pharyngoskop
Pharyngoscope

FLEXIBLE RHINO-PHARYNGO-LARYNGO-FIBERSKOPE
FLEXIBLE RHINO-PHARYNGO-LARYNGO-FIBERSCOPIES

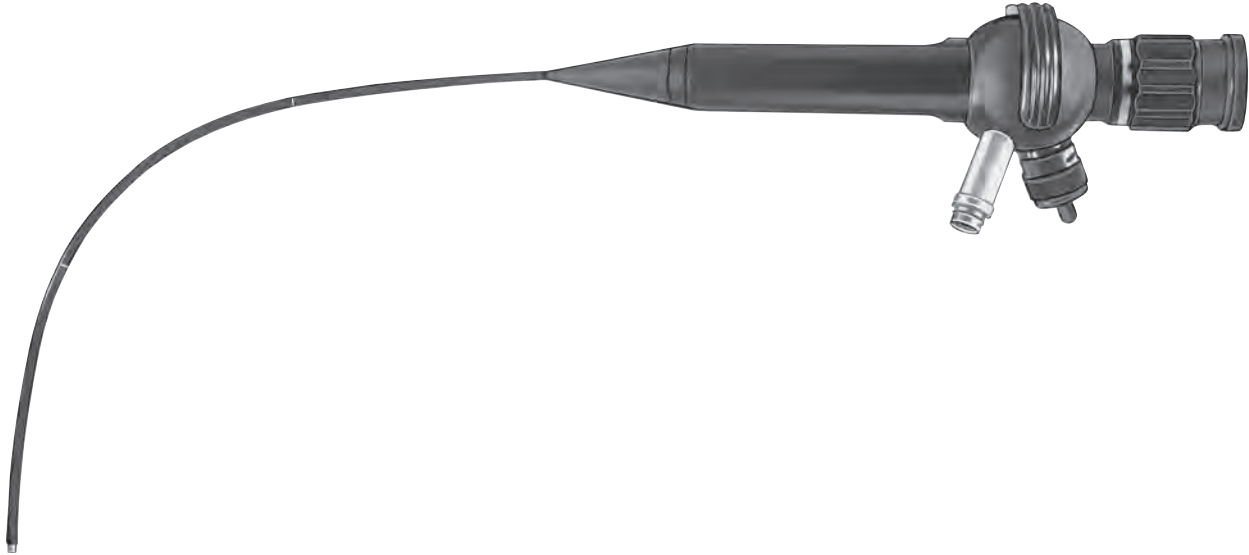

Flexibles Rhino-Pharyngo-Laryngo-Fiberskop zur Diagnostik
Flexible Rhino-Pharyngo-Laryngo-Fiberscope for diagnostics

EN200-010 Ø 3,4 mm
EN200-011 Ø 3,6 mm

Technische Daten/Technical details:

Arbeitslänge/working length:	300 mm
Abwinkelung – auf und ab/deflection – up/down:	150°/150°
Zubehör inklusive:	Dichtigkeitsprüfer, Druckausgleichskappe für Gassterilisation, Transportkoffer
Accessories included:	Leakage tester, ETO valve, transport suitcase

Flexibles Rhino-Pharyngo-Laryngo-Fiberskop zur Diagnostik und Therapie
Flexible Rhino-Pharyngo-Laryngo-Fiberscope for diagnostics and therapy

RU 0752-00

Technische Daten/Technical details:

Bildwinkel/field of view:	95°
Tiefenschärfe/depth of focus:	5-50 mm
Arbeitslänge/working length:	340 mm
Durchmesser/diameter:	4,0 mm
Abwinkelung – auf/ab/deflection – up/down:	110°/100°
Arbeitskanal/working channel:	1,4 mm
Zubehör inklusive:	Flexible Biopsiezange, flexible Reinigungsbürste, Dichtigkeitstester, Entlüftungskappe, Silikon-Schlauch, Bedienungsanleitung, Transportkoffer
Accessories included:	Biopsy forceps, flexible cleaning brush, leakage tester, ETO valve, cleaning tube, leakage cap, silicone tube, instruction manual, transport suitcase

ZANGEN FÜR FLEXIBLE ENDOSKOPE
FORCEPS FOR FLEXIBLE ENDOSCOPES

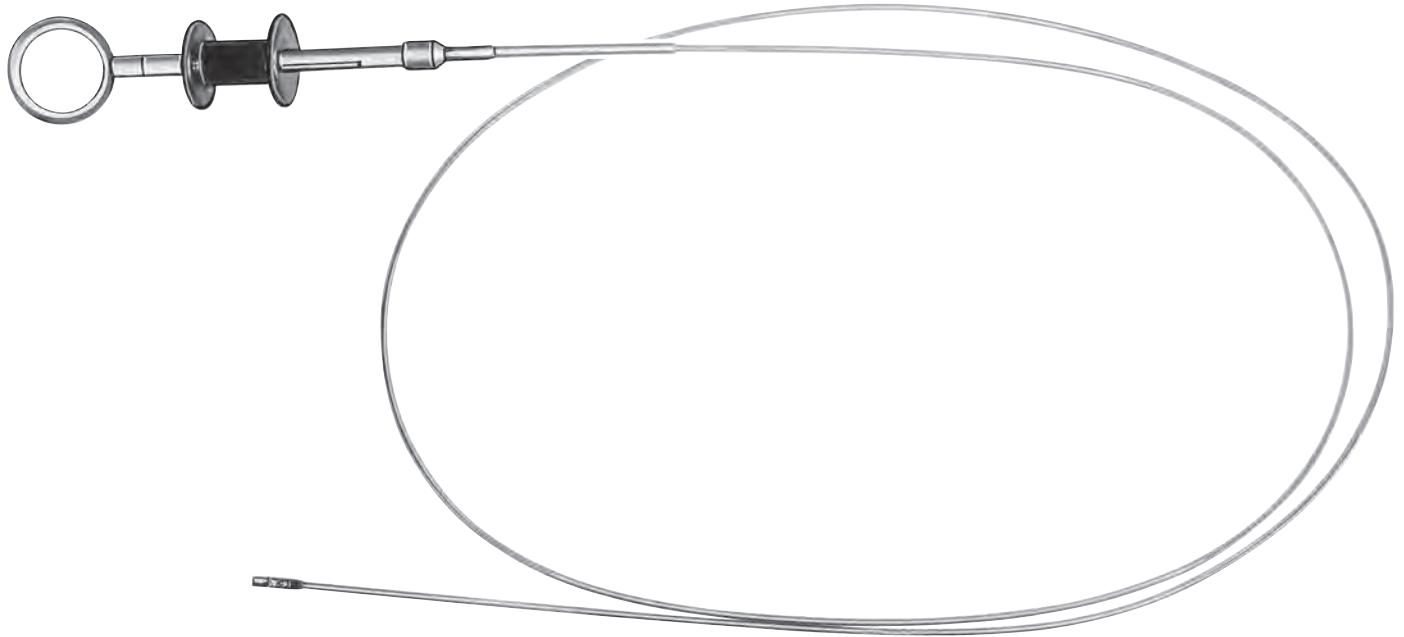

Flexible Zangen für Rhino-Pharyngo-Laryngo-Fiberskope RU 0752-00
Flexible forceps for Rhino-Pharyngo-Laryngo-Fiberscope RU 0752-00



Ø 1,0 mm
Länge/length 120 cm

RF 1010-12

Faßzange, Alligatormaul
Grasping forceps, alligator jaw



Ø 1,0 mm
Länge/length 120 cm
kurzes Maul/short jaw

RF0110-12

Ovaler Löffel
Oval spoon

KALTLICHTKABEL-HTT - KABEL
COLD LIGHT CABLES-HTT - CABLES



20% mehr Lichttransmission gegenüber standard Lichtleitkabeln

20% more light than with standard cables

- Hergestellt aus optischen Qualitätsglasfasern
- Hohe Lichttransmission, hohe Temperaturbeständigkeit
- Innenliegender Knickschutz für lange Lebensdauer
- Hohe Flexibilität für störungsfreies Arbeiten
- Austauschbares Adaptersystem ohne Lichtverluste
- Anwendbar für alle marktüblichen Kaltlichtquellen und Endoskope
- Sterilisierbar im Autoklav

- Made of high-quality optic fibreglass
- High light transmission, high temperature-resistance
- Inner bending protection for long service life
- High flexibility for trouble-free working
- Interchangeable fitting system without light loss
- Fit all cold light sources and endoscopes
- Autoclavable

High Transmission Technology

Verschmolzene Lichtleitfasern/Assembled fibres

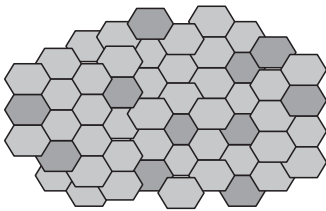

Standard Kabel / Cables

Verklebte Lichtleitfasern/Glued fibres

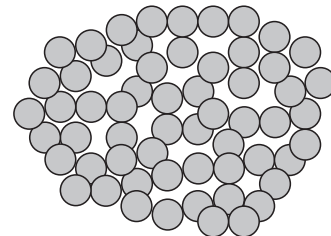

















HTT-Kabel * HTT-Cables *			Standard Kabel Standard cables	
Bestell-Nr. Ordering number	Länge Length	Durchmesser Diameter	Bestell-Nr. Ordering number	
IM201-180	1 800 mm	3.5 mm	IM210-180	
IM201-230	2 300 mm	3.5 mm	IM210-230	
IM201-300	3 000 mm	3.5 mm	-	
IM201-350	3 500 mm	3.5 mm	-	
IM202-180	1 800 mm	4.8 mm	IM212-180	
IM202-230	2 300 mm	4.8 mm	IM212-230	
IM202-300	3 000 mm	4.8 mm	-	
IM202-350	3 500 mm	4.8 mm	-	

* speziell geeignet für Xenon Lichtquellen

* recommended for Xenon light sources

ADAPTER FÜR KALTLICHTKABEL
FITTINGS FOR COLD LIGHT

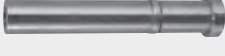
Adapter Endoskop <i>Fitting endoscope</i>	Anschluss <i>Connection</i>	Bestell-Nr. <i>Ordering number</i>
	RUDOLF / Storz / Olympus / Winter&lbe / Aesculap	IM220-020
	Wolf / Henke-Sass / Dyonics / ID = 9,0mm	IM220-021
	ACMI /British Standard /Codman /ID = 7,7mm	IM220-022
	Heine	IM220-023
	Schott / Zeiss	IM220-024
	Stryker	IM220-025

Adapter Lichtquelle <i>Fitting light source</i>	Anschluss <i>Connection</i>	Bestell-Nr. <i>Ordering number</i>
	RUDOLF / Storz / Aesculap	IM220-040
	Wolf / Henke-Sass / Dyonics / Comeg / Medicon	IM220-041
	ACMI / British Standard / Codman / Welch Allyn / Stryker	IM220-042
	Olympus	IM220-043
	Heine	IM220-044
	Schott / Zeiss	IM220-045
	Winter&lbe	IM220-046
	Pentax	IM220-047
	Fuji	IM220-048
	Volpi	IM220-049

SINUSKOP-HANDGRIFFE, SCHÄFTE
SINUSCOPE HANDLES, TUBES



für 2,7 mm-Optiken
for use with 2.7 mm telescopes
102 mm

RU 0165-01

für 4,0 mm-Optiken
for use with 4.0 mm telescopes
102 mm

RU 0165-03

Sinuskop-Handgriffe, rund
Sinuscope handles, round

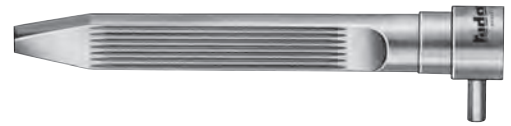

für 2,7 mm-Optiken
for use with 2.7 mm telescopes
102 mm

RU 0165-02

für 4,0 mm-Optiken
for use with 4.0 mm telescopes
102 mm

RU 0165-04

Sinuskop-Handgriffe, flach
Sinuscope handles, flat



RU 0165-50
Saug-Spül-Handgriff
Suction-Irrigation-Handle



RU 0165-51 2,7 mm, 0° und 30°
RU 0165-52 2,7 mm, 70°



RU 0165-56 4,0 mm, 0° und 30°
RU 0165-57 4,0 mm, 70°

Adaptierbare Schäfte
Adaptable tubes



Bei dieser Katalog-Auflage handelt es sich um einen Nachdruck mit geringfügigen Änderungen; daher entfällt der ursprüngliche Inhalt auf dieser Seite.

This catalogue edition is a reprint with minor amendments. This is why the initial content of this page has been removed.



HOCHFREQUENZ - CHIRURGIE

HIGH - FREQUENCY SURGERY

Seiten 13 - 38

Pages 13 - 38

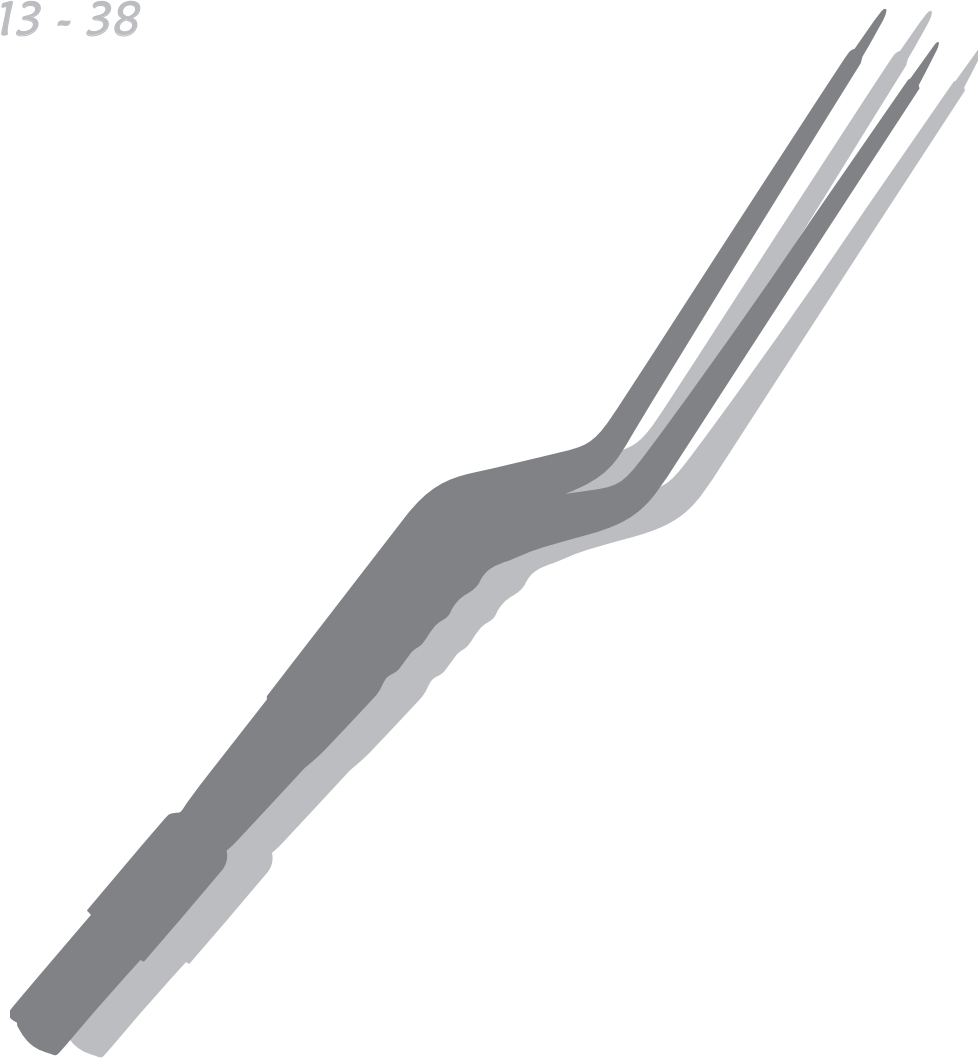

Übersicht

Bipolare Pinzetten
Elektrodenhandgriffe, Kabel, Adapter
Elektroden, Zubehör
Bipolar-Elektroden-System
Kauter, Transformator, Brenner

Overview

*Bipolar forceps
Electrode handles, cables, adapters
Electrodes, accessories
Bipolar electrode system
Cauteries, transformers, tips*

Seiten / Pages

16-20
21-25, 27-29
26, 30-31
32-35
36-37



Bei dieser Katalog-Auflage handelt es sich um einen Nachdruck mit geringfügigen Änderungen; daher entfällt der ursprüngliche Inhalt auf dieser Seite.

This catalogue edition is a reprint with minor amendments. This is why the initial content of this page has been removed.



Bei dieser Katalog-Auflage handelt es sich um einen Nachdruck mit geringfügigen Änderungen; daher entfällt der ursprüngliche Inhalt auf dieser Seite.

This catalogue edition is a reprint with minor amendments. This is why the initial content of this page has been removed.

BIPOLARE PINZETTEN, ISOLIERT
BIPOLAR FORCEPS, INSULATED



0,7 mm
16,5 cm/6½"
RU 4300-27



0,7 mm
19 cm/7½"
RU 4300-28

für Tonsillen Chirurgie
for tonsil surgery

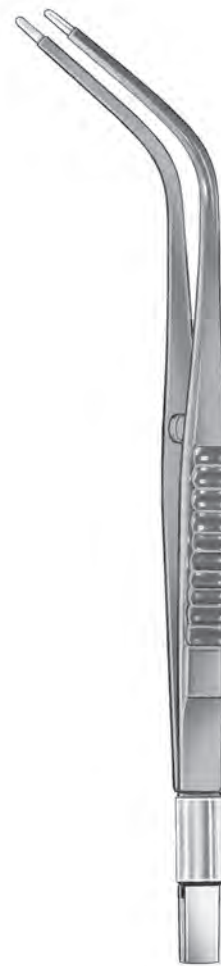

19 cm/7½"
RU 4300-30

für Adenotomie
for pharyngeal surgery

BIPOLARE PINZETTEN, ISOLIERT
BIPOLEAR FORCEPS, INSULATED



16,5 cm/6½"
spitz/pointed
RU 4300-50



1 mm
16,5 cm/6½"
RU 4300-51



16,5 cm/6½"
fein/fine
RU 4300-55



16,5 cm/6½"
spitz/pointed
RU 4300-56



1 mm
16,5 cm/6½"
RU 4300-57



16,5 cm/6½"
fein/fine
RU 4300-60



16,5 cm/6½"
spitz/pointed
RU 4300-61



16,5 cm/6½"
fein/fine
RU 4300-65



16,5 cm/6½"
spitz/pointed
RU 4300-66



1 mm
16,5 cm/6½"
RU 4300-67

BIPOLEARE PINZETTEN, ISOLIERT
BIPOLEAR FORCEPS, INSULATED



19 cm / 7 1/2"
spitz / pointed
RU 4300-70



1 mm
19 cm / 7 1/2"
RU 4300-71



1 mm
19 cm / 7 1/2"
RU 4300-75



2 mm
19 cm / 7 1/2"
RU 4300-76



19,5 cm / 7 3/4"
spitz / pointed
RU 4301-01



1 mm
19,5 cm / 7 3/4"
RU 4301-02



2 mm
19,5 cm / 7 3/4"
RU 4301-03

BIPOLARE PINZETTEN MIT TC-EINLAGE, ISOLIERT
BIPOlar FORCEPS WITH TC INSERT, INSULATED

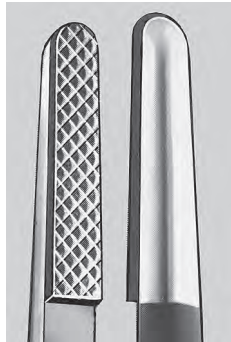

Tc

- **sicheres Fassen**
safe grasping
- **praktisch kein Anhaften von Gewebe**
virtually no tissue sticking
- **sehr guter Gefäßverschluß**
excellent vessel closure



2,2 mm
16,5 cm/6½"

RU 4302-46

2,2 mm
19 cm/7½"

RU 4302-49

2,2 mm
22 cm/8¾"

RU 4302-52

2,2 mm
19 cm/7½"

RU 4302-76

2,2 mm
19 cm/7½"

RU 4302-82



Bei dieser Katalog-Auflage handelt es sich um einen Nachdruck mit geringfügigen Änderungen; daher entfällt der ursprüngliche Inhalt auf dieser Seite.

This catalogue edition is a reprint with minor amendments. This is why the initial content of this page has been removed.

ELEKTRODENHANDGRIFFE UND ANSCHLUSSKABEL ELECTRODE HANDLES AND CABLES

Ø 4 mm



Elektrodenhandgriffe mit 2 Tasten
Electrode handles with 2 buttons

Nur in Verbindung mit RUDOLF-Kabel einsetzbar!
For use with RUDOLF cables only!

RU 0465-01/01 für Erbe ACC/ICC-Geräte
for Erbe ACC/ICC units

RU 0465-01/02 für Erbe T 400/T 300/T 175 E-Geräte
for Erbe T 400/T 300/T 175 E units

RU 0465-01/03 für Berchtold/Martin/Aesculap GN-Geräte
for Berchtold/Martin/Aesculap GN units

Ø 4 mm



Elektrodenhandgriff mit 1 Taste
Electrode handle with 1 button

Nur in Verbindung mit RUDOLF-Kabel einsetzbar!
For use with RUDOLF cables only!

RU 0465-01/04 für RUDOLF/Berchtold/Martin/Aesculap GN-Geräte
for RUDOLF/Berchtold/Martin/Aesculap GN units

Ø 5 mm



Anschlußkabel für Elektrodenhandgriff an Erbe ACC/ICC-Geräte
Cable for electrode handle to Erbe ACC/ICC units

RU 0466-01/03 – 3 m
RU 0466-01/05 – 5 m

Ø 4 mm



Anschlußkabel für Elektrodenhandgriff an Erbe T-Geräte
Cable for electrode handle to Erbe T units

RU 0466-02/03 – 3 m
RU 0466-02/05 – 5 m

G



Anschlußkabel für Elektrodenhandgriff an RUDOLF/Berchtold/Martin/Aesculap GN-Geräte
Cable for electrode handle to RUDOLF/ Berchtold/Martin/Aesculap GN units

RU 0466-03/03 – 3 m
RU 0466-03/05 – 5 m

G = geräteseitig / equipment side

ELEKTRODENHANDGRIFFE MIT FESTEM KABEL
ELECTRODE HANDLES WITH FIXED CABLE



für Erbe ACC/ICC-Geräte
for Erbe ACC/ICC units

RU 0465-01/13 mit Kabel / with cable 3 m
RU 0465-01/15 mit Kabel / with cable 5 m



Elektrodenhandgriffe mit 2 Tasten und festem Kabel
Electrode handles with 2 buttons and fixed cable



für Berchtold/Martin/Aesculap GN-Geräte
for Berchtold/Martin/Aesculap GN units

RU 0465-01/33 mit Kabel / with cable 3 m
RU 0465-01/35 mit Kabel / with cable 5 m



Elektrodenhandgriffe mit 2 Tasten und festem Kabel
Electrode handles with 2 buttons and fixed cable

ELEKTRODENHANDGRIFFE MIT FESTEM KABEL, ADAPTER
ELECTRODE HANDLES WITH FIXED CABLE, ADAPTORS

Elektrodenhandgriffe mit 2 Tasten und festem Kabel
Electrode handles with 2 buttons and fixed cable

Ø 4 mm oder/or
Ø 2,4 mm



für Martin/Berchtold/Erbe International/Valleylab/Conmed-Geräte
for Martin/Berchtold/Erbe International/Valleylab/Conmed units

RU 0465-02/03 mit Kabel / with cable 3 m – Schaft/shaft Ø 4 mm

RU 0465-02/05 mit Kabel / with cable 5 m – Schaft/shaft Ø 4 mm

RU 0465-02/13 mit Kabel / with cable 3 m – Schaft/shaft Ø 2,4 mm

RU 0465-02/15 mit Kabel / with cable 5 m – Schaft/shaft Ø 2,4 mm



Ø 4 mm oder/or
Ø 2,4 mm



für Martin/Berchtold/Erbe International/Valleylab/Conmed-Geräte
for Martin/Berchtold/Erbe International/Valleylab/Conmed units

RU 0465-03/03 mit Kabel / with cable 3 m – Schaft/shaft Ø 4 mm

RU 0465-03/05 mit Kabel / with cable 5 m – Schaft/shaft Ø 4 mm

RU 0465-03/13 mit Kabel / with cable 3 m – Schaft/shaft Ø 2,4 mm

RU 0465-03/15 mit Kabel / with cable 5 m – Schaft/shaft Ø 2,4 mm



Ø 4 mm



Elektrodenhandgriffe mit 1 Taste und festem Kabel
Electrode handles with 1 button and fixed cable

für RUDOLF/Martin/Berchtold/Aesculap GN-Geräte
for RUDOLF/Martin/Berchtold/Aesculap GN units

RU 0465-08/03 mit Kabel / with cable 3 m – Schaft/shaft Ø 4 mm

RU 0465-08/05 mit Kabel / with cable 5 m – Schaft/shaft Ø 4 mm



Adapter für Martin Geräte
der Serie 2000

Adaptor for Martin
equipment of the 2000 line

RU 0467-02

ELEKTRODENHANDGRIFFE MIT FESTEM KABEL
ELECTRODE HANDLES WITH FIXED CABLE

Elektrodenhandgriffe ohne Tasten, mit festem Kabel
Electrode handles without buttons, with fixed cable

Ø 4 mm



Ø 5 mm



für Erbe ACC/ICC-Geräte
for Erbe ACC/ICC units

RU 0465-04/03 mit Kabel / with cable 3 m

Ø 4 mm oder/or
Ø 2,4 mm



für RUDOLF/Berchtold/Martin/Aesculap GN-Geräte
for RUDOLF/Berchtold/Martin/Aesculap GN units

RU 0465-05/05 mit Kabel / with cable 5 m – Schaft/shaft Ø 4 mm

RU 0465-05/13 mit Kabel / with cable 3 m – Schaft/shaft Ø 2,4 mm

Ø 4 mm oder/or
Ø 2,4 mm



Ø 8 mm



für Valleylab/USA-Geräte
for Valleylab/USA units

RU 0465-06/03 mit Kabel / with cable 3 m – Schaft/shaft Ø 4 mm

RU 0465-06/05 mit Kabel / with cable 5 m – Schaft/shaft Ø 4 mm

RU 0465-06/13 mit Kabel / with cable 3 m – Schaft/shaft Ø 2,4 mm

RU 0465-06/15 mit Kabel / with cable 5 m – Schaft/shaft Ø 2,4 mm

Ø 2,4 mm



Ø 4 mm



mit 4 mm Federkorbstecker, für diverse Gerätetypen, Erbe T-Geräte
with 4 mm banana plug, for various equipment, Erbe T-equipment

RU 0465-07/13 mit Kabel / with cable 3 m

ANSCHLUSSKABEL FÜR NEUTRALELEKTRODEN CABLES FOR NEUTRAL ELECTRODES



Anschlußkabel für Gummi-Neutralelektroden
an Erbe-Geräte
Cable for rubber neutral electrodes to Erbe equipment

RU 0466-15/03 – 3 m



Anschlußkabel für Gummi-Neutralelektroden
an RUDOLF/Berchtold/Martin/Aesculap GN-Geräte
Cable for rubber neutral electrodes to RUDOLF/
Berchtold/Martin/Aesculap GN units

RU 0466-18/05 – 5 m



Anschlußkabel für Einmal-Neutralelektroden ohne Ka-
bel an RUDOLF/Berchtold/Martin/Aesculap GN-Geräte
Cable for disposable neutral electrodes without cable to
RUDOLF/Berchtold/Martin/Aesculap GN units

RU 0466-17/03 – 3 m
RU 0466-17/05 – 4,5 m



Anschlußkabel für Gummi-Neutralelektroden
an Valleylab/Conmed-Geräte
Cable for rubber neutral electrodes to Valleylab/
Conmed units

RU 0466-19/03 – 3 m
RU 0466-19/05 – 5 m

G = geräteseitig / equipment side

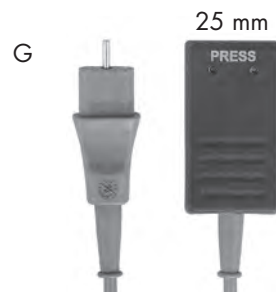

Anschlußkabel für Einmal-Neutralelektroden ohne
Kabel an Valleylab/Conmed-Geräte
Cable for disposable neutral electrodes without cable to
Valleylab/Conmed units

RU 0466-20/03 – 3 m
RU 0466-20/05 – 4,5 m

GUMMI-NEUTRALELEKTRODEN UND ZUBEHÖR
RUBBER NEUTRAL ELECTRODES AND ACCESSORIES

autoklavierbar / autoclavable
max 134°C, 2,3 bar



Gummi-Neutralelektrode an Erbe-Geräte mit Anschlußkabel 50 cm
Rubber neutral electrode to Erbe equipment with connecting cable 50 cm

für Erwachsene/*for adults*
245 x 145 cm

für Kinder/*for children*
168 x 112 cm

RU 0466-30/01

RU 0466-30/02



Gummi-Neutralelektrode an RUDOLF/Berchtold/Martin/Aesculap GN/Valleylab/
Conmed-Geräte mit Anschlußkabel 50 cm
Rubber neutral electrode to RUDOLF/Berchtold/Martin/Aesculap GN/Valleylab/
Conmed equipment with connecting cable 50 cm

für Erwachsene/*for adults*
245 x 145 mm

für Kinder/*for children*
168 x 112 mm

RU 0466-32/01

RU 0466-32/02



Elastische Gummibinde, gelocht, mit Befestigungsknopf
Elastic rubber band, with holes, with fixing button

50 cm

100 cm

RU 0466-34/50

RU 0466-34/55



Befestigungsknopf, allein
Fixing button, only

RU 0466-36/01

MONOPOLARE KABEL
MONOPOLAR CABLES

Monopolare Kabel
Monopolar cables

3 m
Type A
männlich/männlich
male/male
RU 0490-35 A



4 m
Type B
männlich/weiblich
male/female
RU 0490-35 B



Monopolare Sicherheits-Kabel
Monopolar safety cables

3,50 m
Anschlußkabel mit Sicherheitshülse für RUDOLF/
Berchtold/Martin und Erbe T-Geräte
Cable with safety shield for RUDOLF/Berchtold/
Martin and Erbe T units
RU 0490-85



3,50 m
Anschlußkabel mit Sicherheitshülse für Erbe
ACC/ICC-Geräte
Cable with safety shield for Erbe ACC/ICC units
RU 0490-86



3,50 m
Anschlußkabel mit Sicherheitshülse für Valleylab-Geräte
Cable with safety shield for Valleylab units
RU 0490-87



BIPOLARE KABEL
BIPOLAR CABLES



Anschlußkabel für bipolare Instrumente (Flachstecker) an Erbe-Geräte
Cable for bipolar instruments (flat plug) to Erbe equipment

RU 0466-43/03 – 3 m
RU 0466-43/05 – 5 m



Anschlußkabel für bipolare Instrumente (Flachstecker) an RUDOLF / Berchtold / Martin / Aesculap GN-Geräte
Cable for bipolar instruments (flat plug) to RUDOLF / Berchtold / Martin / Aesculap GN equipment

RU 0466-44/03 – 3 m
RU 0466-44/05 – 5 m



Anschlußkabel für bipolare Instrumente (Flachstecker) mit 2 Bananensteckern an diverse Gerätetypen (z. B. Erbe International)
Cable for bipolar instruments (flat plug) with 2 banana plugs to various equipment (e.g. Erbe International)

RU 0466-45/03 – 3 m
RU 0466-45/05 – 5 m



Anschlußkabel für bipolare Instrumente (Flachstecker) an Valleylab/Lamidey-Geräte
Cable for bipolar instruments (flat plug) to Valleylab / Lamidey equipment

RU 0466-46/03 – 3 m
RU 0466-46/05 – 5 m



Anschlußkabel für bipolare Instrumente (Flachstecker) an EMC/Dolley-Geräte
Cable for bipolar instruments (flat plug) to EMC / Dolley equipment

RU 0466-47/03 – 3 m
RU 0466-47/05 – 5 m



Anschlußkabel für bipolare Instrumente (Flachstecker) an Conmed-Geräte
Cable for bipolar instruments (flat plug) to Conmed equipment

RU 0466-48/03 – 3 m
RU 0466-48/05 – 5 m

G = geräteseitig/equipment side

BIPOLARE KABEL
BIPOLAR CABLES

Bipolare Anschlußkabel für Pinzetten mit US Anschluß
Bipolar cables for US type forceps (2 pins)



Anschlußkabel an Erbe-Geräte
Cable to Erbe units

RU 0466-60/04 – 4,5 m

Anschlußkabel an RUDOLF/
Martin/Berchtold-Geräte
Cable to RUDOLF/Martin/
Berchtold units

RU 0466-62/04 – 4,5 m

Anschlußkabel an Valleylab/
Lamidey-Geräte
Cable to Valleylab/Lamidey
units

RU 0466-64/04 – 4,5 m

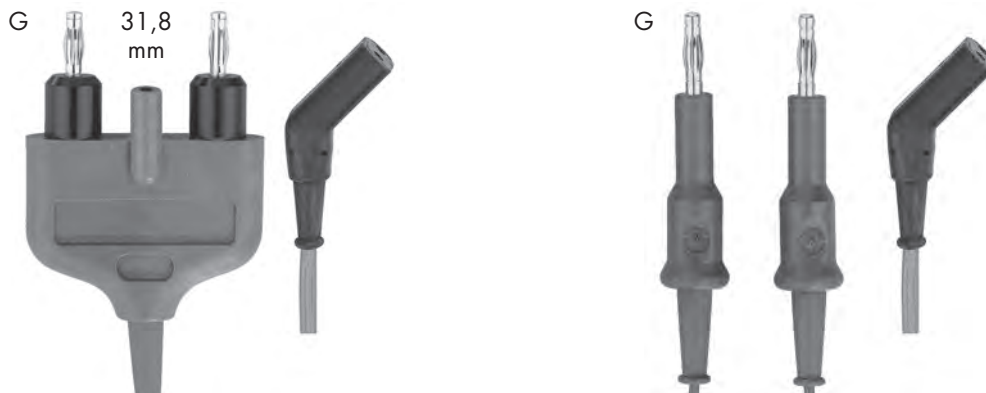

Anschlußkabel an Conmed-Geräte
Cable to Conmed units

RU 0466-66/03 – 3 m
RU 0466-66/05 – 5 m







Anschlußkabel mit 2 Bananen-
steckern für diverse Gerätetypen
Cable with 2 banana plugs for
various units

RU 0466-68/04 – 4,5 m

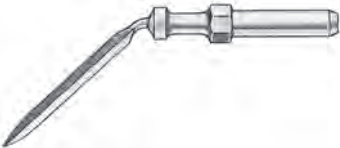
G = geräteseitig/equipment side

MONOPOLARE STANDARD-ELEKTRODEN, 6-KANT-SCHAFT
MONOPOLAR STANDARD ELECTRODES, 6-EDGE SHAFT

Behälter für diese Elektroden finden Sie auf Seite 31
Containers for these electrodes are on page 31

Bezeichnung Description		Maße size	Ø 2,4 mm Schaft Ø 2,4 mm shaft	Ø 4 mm Schaft Ø 4 mm shaft
Lanzetten-Elektrode Lancet electrode			RU 0470-51	RU 0470-01
Lanzetten-Elektrode Lancet electrode			RU 0470-52	RU 0470-02
Messer-Elektrode Knife electrode			RU 0470-54	RU 0470-04
Nadel-Elektrode Needle electrode		22 mm	RU 0470-60	RU 0470-10
		30 mm		RU 0470-11
Kugel-Elektrode Ball electrode		Ø 2 mm	RU 0470-65	RU 0470-15
		Ø 4 mm	RU 0470-67	RU 0470-17
		Ø 6 mm	RU 0470-69	RU 0470-19
Bandschlingen-Elektrode Wire loop electrode		Ø 10 mm	RU 0470-74	RU 0470-24
		Ø 15 mm		RU 0470-26
		Ø 17 mm		RU 0470-28
Drahtschlingen-Elektrode Wire loop electrode		Ø 5 mm		RU 0470-31
		Ø 10 mm	RU 0470-83	RU 0470-33
		Ø 14 mm	RU 0470-85	RU 0470-35
		Ø 20 mm		RU 0470-37
Platten-Elektrode Plate electrode		8 x 10 mm		RU 0470-41
		10 x 10 mm		RU 0470-42
		12 x 10 mm		RU 0470-43

ZUBEHÖR FÜR ELEKTRODEN
ACCESSORIES FOR ELECTRODES



RU 0471-88

Ø 4 mm – Ø 1,6 mm

Reduzierstück für Dental-Elektroden

Reducer for dental electrodes

RU 0471-89

Ø 4 mm – Ø 2,40 mm

Reduzierstück für HF-Elektroden, USA-Modell

Reducer for HF electrodes, US pattern



100 mm

RU 0471-90

150 mm

RU 0471-95

Elektrodenverlängerung für Ø 4 mm Schaft

Electrode extension for Ø 4 mm shaft

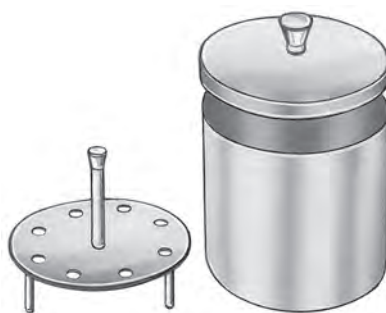

Ø 4,0 mm Schaft/shaft

RU 8915-01

Ø 1,6 mm Schaft/shaft

RU 8915-02

Ø 2,4 mm Schaft/shaft

RU 8915-04

Elektroden-Behälter für 8 Elektroden

Electrode container for 8 electrodes

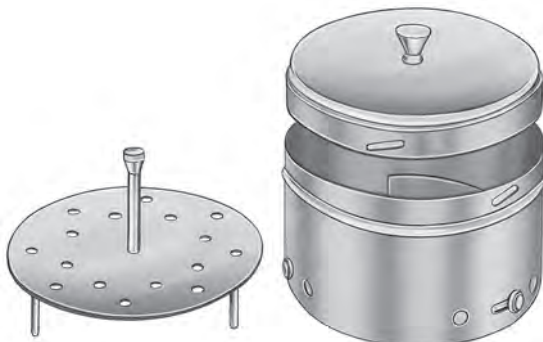

Ø 4,0 mm Schaft/shaft

RU 8915-03

Elektroden-Behälter für 16 Elektroden

Electrode container for 16 electrodes

BIPOLARE ELEKTRODEN FÜR HNO
BIPOLAR ELECTRODES FOR ENT

autoklavierbar/*autoclavable*
max. 134°C, 2,3 bar

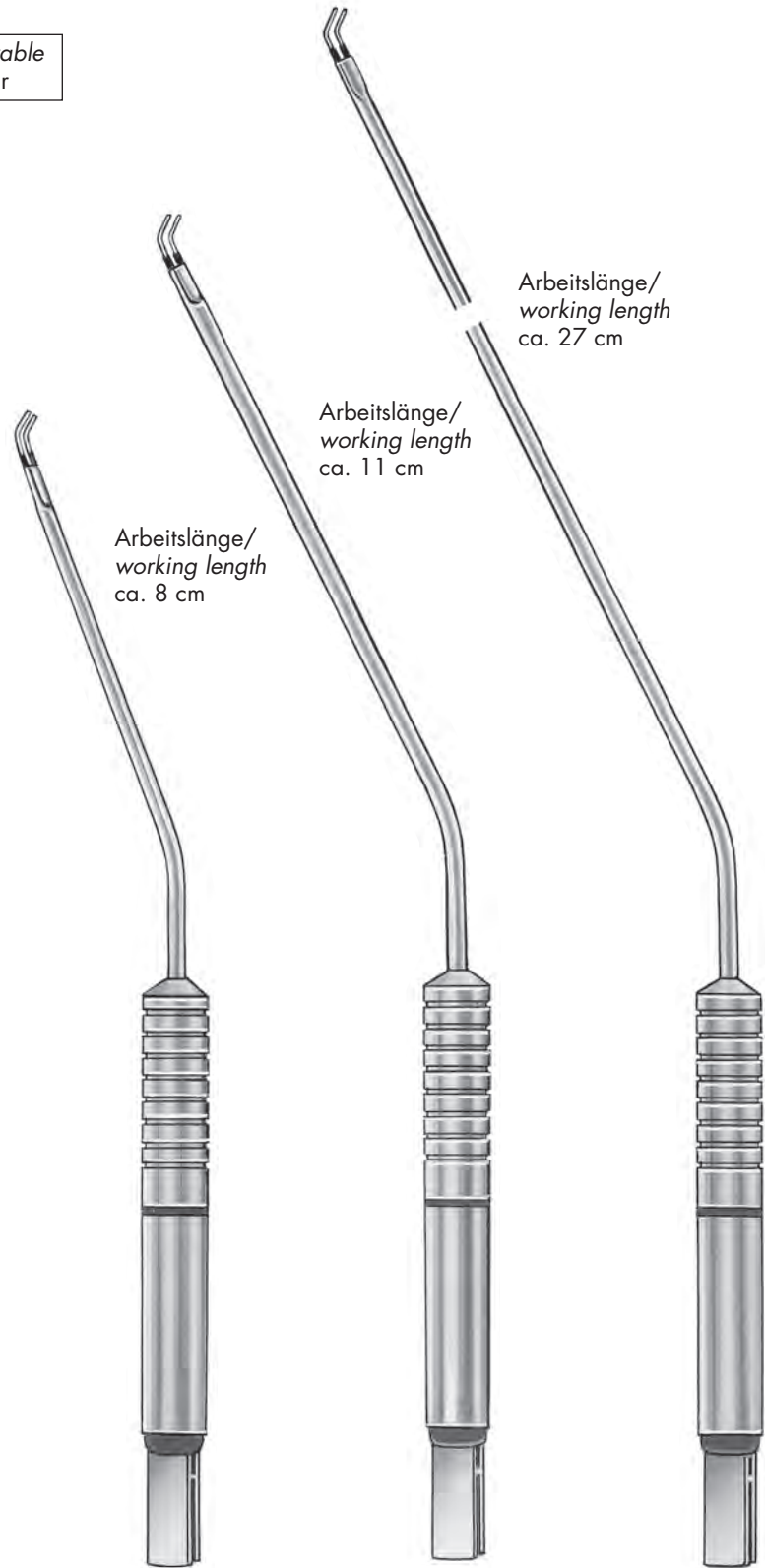

Bipolare Elektroden zum punkt- und flächenförmigen Koagulieren. Durch die schlanke Form hat der Chirurg eine gute Übersicht im Operationsfeld. Der starre Abstand der Elektrodenspitzen bietet eine optimale Koagulationsleistung. Aus rostfreiem Stahl.

Bipolar electrodes for either "pinpoint" coagulation or coagulation over a larger surface. The slim design of the instrument allows the surgeon an unobstructed view of the operation site. The fixed distance between the electrode tips ensures a perfect coagulation. Material: Stainless Steel.

RU 4305-01/19
für Nase/*for nose*

RU 4305-01/22
für Tonsille/*for tonsil*

RU 4305-01/35
für Larynx/*for larynx*

Die Isolierung liegt geschützt innerhalb des Schafts!
The insulation lies inside the shaft and is protected against damage!

BIPOLARE ELEKTRODEN FÜR HNO
BIPOLAR ELECTRODES FOR ENT

autoklavierbar / autoclavable
max. 134°C, 2,3 bar

Arbeitslänge/
working length
ca. 10 cm



Arbeitslänge/
working length
ca. 11 cm

Arbeitslänge/
working length
ca. 11 cm

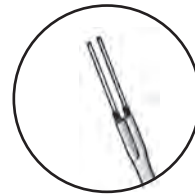

90° abgewinkelt
90° angled

RU 4305-02/01

Bipolare Elektroden für
die Koagulation der
Rachenmandeln.

*Bipolar electrodes for
coagulation of the
pharyngeal tonsils.*

45° abgewinkelt
45° angled

RU 4305-02/02

RU 4305-02/03

Bipolare Nadelelektrode
zur Koagulation der
Nasenmuschel.

*Bipolar needle for
coagulation of the
turbinal (concha
nasalis inferior).*

Die Isolierung liegt geschützt innerhalb des Schafts!
The insulation lies inside the shaft and is protected against damage!



Bei dieser Katalog-Auflage handelt es sich um einen Nachdruck mit geringfügigen Änderungen; daher entfällt der ursprüngliche Inhalt auf dieser Seite.

This catalogue edition is a reprint with minor amendments. This is why the initial content of this page has been removed.



Bei dieser Katalog-Auflage handelt es sich um einen Nachdruck mit geringfügigen Änderungen; daher entfällt der ursprüngliche Inhalt auf dieser Seite.

This catalogue edition is a reprint with minor amendments. This is why the initial content of this page has been removed.

**KAUTER, TRANSFORMATOR, BRENNER
CAUTERIES, TRANSFORMER, TIPS**

Kautergriff in Pistolenform

RU 9576-01 Kautergriff in Pistolenform für Kurzzeitanwendungen, passend zu Netzgerät **RU 9576-10**. Mit Tastschalter und separatem Anschlußkabel mit Sicherheitslaborsteckern. Nicht autoklavierbar.

Pistol shaped Cautery Handle

RU 9576-01 Pistol shaped cautery handle for short time use. Suitable with cautery transformer **RU 9576-10**. With tipswitch and separate connecting cable with safety plugs. Not autoclavable.



Kautergriff nach Schech

RU 9576-02 Kautergriff nach Schech für Kurzzeitanwendungen, passend zu Netzgerät **RU 9576-10**. Mit Tastschalter, integriertem Anschlußkabel und Sicherheitslaborsteckern. Nicht autoklavierbar.

Cautery Handle by Schech

RU 9576-02 Cautery handle for short time use. Suitable with cautery transformer **RU 9576-10**. With tip-switch, integrated connecting cable and safety plugs. Not autoclavable.

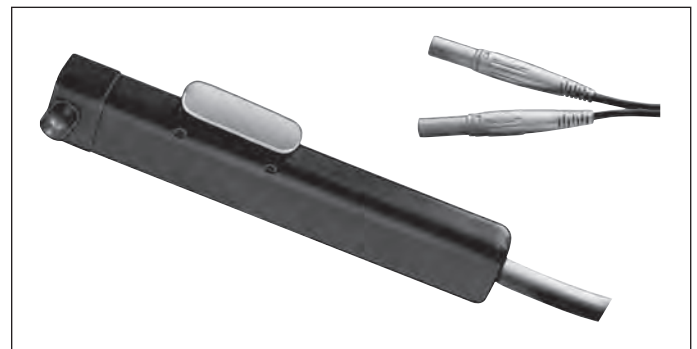

Netzgerät für Thermokaustik

RU 9576-10 Ausgang stufenlos regelbar bis maximal 20 Ampère. Dadurch beliebig einstellbare und reproduzierbare Brenntemperatur. Ausgerüstet mit zwei Laborbuchsen für Bananenstecker. Netzkabel im Lieferumfang enthalten. Für äußerliche Anwendungen.

Transformer for Thermo-Cautery

RU 9576-10 Output infinitely variable up to a maximum of 20 ampere. Therefore adjustable and reproducible temperatures of the tips. With two safety adaptors for banana plugs. Cable for main supply included. For external use.



Platin-Iridium-Brenner, Tips of platinum-iridium

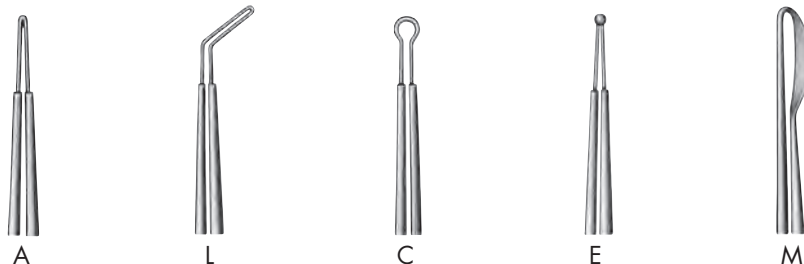

Länge/Length	A	L	C	E	M
10 cm/4"	RU 9576-21	RU 9576-22	RU 9576-23	RU 9576-24	RU 9576-25
15 cm/6"	RU 9576-31	RU 9576-32	RU 9576-33	RU 9576-34	RU 9576-35

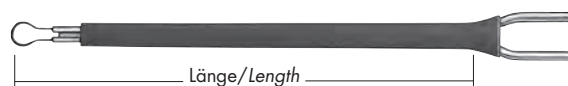

AKKU-KAUTER RECHARGEABLE CAUTERY

Dieser neue, kabellose Glühkauter ist mit Hochleistungsakkus und neuester intelligenter Ladetechnik ausgestattet. Seine hohe Leistung ermöglicht sowohl den Einsatz feinsten Spitzen, wie für unseren Batteriekauter, als auch stärkerer Spitzen für kleine chirurgische Eingriffe. Die hervorragende Handlichkeit bei niedrigem Gewicht und die breite Palette der hochwertigen Platin-Iridium-Brenner sorgen für hohen Arbeitskomfort und Langlebigkeit.

The new wireless heat cautery system includes a high power rechargeable battery and a modern, intelligent charger. The advanced power system allows the use of finest tips up to strong tips for the use in minor surgery. The slim, light weight handle and the high quality platinum tips guarantee best comfort and a long lifetime.

Akku-Kauter-Set/Rechargeable Cautery Set

- RU 9577-00** Ladestation mit Griff und Akku
Charger incl. handle and rechargeable battery
- RU 9577-02** Akku-Kauterset: Ladestation, Steckernetzteil, Handgriff, Akku, 2 Brenner RU 9577-21, RU 9577-22 (Fig. A, L), 3 cm
Cautery Set: Charger, wall plug transformer, handle, rech. Battery, 2 tips RU 9577-21, RU 9577-22 (Fig. A, L)
- RU 9577-05** Set mit 5 Brennern/Set with 5 tips
RU 9577-24, -27, -28, -29, -30 (Fig. P, K, A, G, E)



Einzelteile und Zubehör/Spare parts and accessories

- RU 9577-10** Griff für Akku-Kauter, ohne Akku
Handle without rech. battery
- RU 9577-11** Ladestation incl. Steckernetzteil
Charger incl. wall plug transformer
- RU 9577-12** Ladestation für Akku-Kautergriff, ohne Trafo
Charger without transformer
- RU 9577-13** Trafo für Ladestation
Wall plug transformer
- RU 9577-14** Akkupack für Akku-Kautergriff RU 9577-10
Rechargeable Battery for RU 9577-10

Platin-Iridium-Brenner, Tips of platinum-iridium

- RU 9577-21** Fig. A fein/fine, ca. 30 mm
- RU 9577-22** Fig. L fein/fine, ca. 30 mm
- RU 9577-23** Fig. C fein/fine, ca. 30 mm
- RU 9577-24** Fig. P fein/fine, ca. 30 mm
- RU 9577-25** Fig. E fein/fine, ca. 30 mm
- RU 9577-27** Fig. K mittel/medium, ca. 30 mm
- RU 9577-28** Fig. A stark/strong, ca. 30 mm
- RU 9577-29** Fig. G stark/strong, ca. 30 mm
- RU 9577-30** Fig. E stark/strong, ca. 30 mm
- RU 9577-31** Fig. A stark/strong, ca. 45 mm
- RU 9577-34** Fig. P stark/strong, ca. 45 mm
- RU 9577-35** Fig. E stark/strong, ca. 45 mm
- RU 9577-36** Fig. G stark/strong, ca. 45 mm
- RU 9577-37** Fig. K stark/strong, ca. 45 mm
- RU 9577-41** Fig. A stark/strong, ca. 115 mm
- RU 9577-45** Fig. E stark/strong, ca. 115 mm
- RU 9577-46** Fig. G stark/strong, ca. 115 mm
- RU 9577-47** Fig. K stark/strong, ca. 115 mm

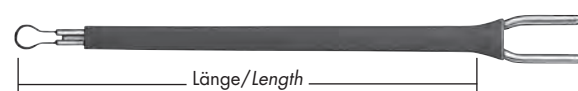

Achtung: die Brennerspitzen **RU 9577-28, -29, -30** sind nur für Kurzzeitgebrauch vorgesehen!
Attention: The tips **RU 9577-28, -29, -30** are only for short time use!



ALLGEMEINES INSTRUMENTARIUM *GENERAL SURGICAL INSTRUMENTS*

Seiten 39 - 152

Pages 39 - 152

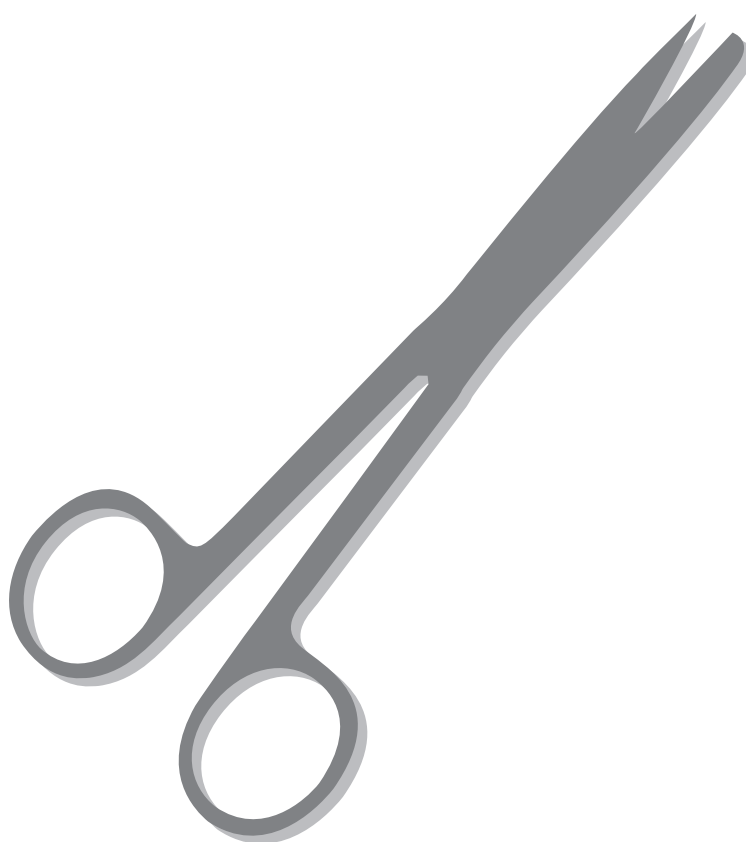

Übersicht

Scheren, Klemmen, Zangen, Pinzetten
Haken, Sperrer
Wangen, Lippenhalter
Skalpellgriffe, -klingen, Rasierklingen
Sonden, Spatel, Watteträger
Messinstrumente, Diagnostik
Trokare, Kanülen, Spritzen
Meißel, Stößel, Osteotome
Löffel, Raspatorien, Elevatorien
Hohlmeißel, Knochensplitterzangen
Hämmer
Nadelhalter, Nadeln
Sonden, Absaugrohre

Overview

Scissors, clamps, forceps
Hooks, retractors
Retractors
Scalpel handles, – blades, razor blades
Probes, spatulas, cotton applicators
Measuring instruments, diagnostic
Trocars, cannulas, syringes
Bone chisels, pestles, osteotomes
Bone curettes, raspatories, elevators
Bone rongeur forceps, – cutting forceps
Mallets
Needle holders, needles
Ligature conductors, Suction tubes

Seiten / Pages

40-88, 128
89-103
103
104-109
110-113
113-124
125-127
129-130
131-135
135-138
138-139
127, 140-149
150-152

**CHIRURGISCHE SCHEREN
OPERATING SCISSORS**



Mod. Rudolf
14,5 cm / 5¾"
gerade / straight
RU 1000-14

mit extra großen Ringen
with extra large rings



Standard
Fig. 1
gerade / straight



Standard
Fig. 2
gerade / straight



Standard
Fig. 3
gerade / straight

11,5 cm / 4½"	RU 1001-11	RU 1002-11	RU 1003-11
13,0 cm / 5"	RU 1001-13	RU 1002-13	RU 1003-13
14,5 cm / 5¾"	RU 1001-14	RU 1002-14	RU 1003-14
15,5 cm / 6"	RU 1001-15	RU 1002-15	RU 1003-15
16,5 cm / 6½"	RU 1001-16	RU 1002-16	RU 1003-16



Standard
14,5 cm / 5¾"
gerade / straight

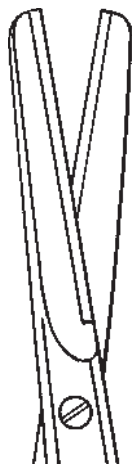

Fig. 1
RU 1004-14

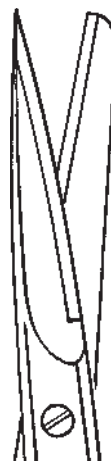

Fig. 2
RU 1006-14



Fig. 3
RU 1008-14

**CHIRURGISCHE SCHEREN
OPERATING SCISSORS**



Mod. Rudolf
14,5 cm / 5¾"
gebogen / curved
RU 1010-14

mit extra großen Ringen
with extra large rings



Standard
Fig. 1
gebogen / curved



Standard
Fig. 2
gebogen / curved



Standard
Fig. 3
gebogen / curved

11,5 cm / 4½"	RU 1011-11	RU 1012-11	RU 1013-11
13,0 cm / 5"	RU 1011-13	RU 1012-13	RU 1013-13
14,5 cm / 5¾"	RU 1011-14	RU 1012-14	RU 1013-14
15,5 cm / 6"	RU 1011-15	RU 1012-15	RU 1013-15
16,5 cm / 6½"	RU 1011-16	RU 1012-16	RU 1013-16



Standard
14,5 cm / 5¾"
gebogen / curved



Fig. 1
RU 1014-14



Fig. 2
RU 1016-14



Fig. 3
RU 1018-14

CHIRURGISCHE SCHEREN, PRÄPARIERSCHEREN
OPERATING SCISSORS, DISSECTING SCISSORS



**Standard
- Grazil -**
gerade / straight

13,0 cm / 5"

RU 1021-13

RU 1022-13

RU 1023-13

RU 1031-13

RU 1032-13

RU 1033-13

14,5 cm / 5¾"

RU 1021-14

RU 1022-14

RU 1023-14

RU 1031-14

RU 1032-14

RU 1033-14



**Standard
- Grazil -**
gebogen / curved



Lexer
16 cm / 6¼"
RU 1101-16

SUPERCUT



Lexer
16 cm / 6¼"
gezähnt / serrated
RU 1101-16 MC

Tc



Lexer
16 cm / 6¼"
RU 1103-16

CHIRURGISCHE SCHEREN, PRÄPARIERSCHEREN
OPERATING SCISSORS, DISSECTING SCISSORS



Mayo
gerade / straight
RU 1250-14

14,5 cm / 5¾"



gebogen / curved
RU 1251-14



Mayo
gerade / straight
RU 1252-14

14,5 cm / 5¾"

gebogen / curved
RU 1253-14



Baby-Metzenbaum
gerade / straight
RU 1280-11

11,5 cm / 4½"



gebogen / curved
RU 1281-11

SUPERCUT



Baby-Metzenbaum
gerade, gezahnt
straight, serrated
RU 1280-11 MC

11,5 cm / 4½"

gebogen, gezahnt
curved, serrated
RU 1281-11 MC

**PRÄPARIERSCHEREN
DISSECTING SCISSORS**



Metzenbaum-Fino
gerade / straight
RU 1290-14



Metzenbaum-Fino
gebogen / curved
RU 1291-14

SUPERCUT



Metzenbaum-Fino
gerade, gezahnt
straight, serrated
RU 1290-14 MC

Metzenbaum-Fino
gebogen, gezahnt
curved, serrated
RU 1291-14 MC



Metzenbaum
14,5 cm / 5¾"
gerade / straight
RU 1301-14



Metzenbaum
14,5 cm / 5¾"
gerade / straight
RU 1304-14

Tc



Metzenbaum-Fino
14,5 cm / 5¾"
gerade / straight
RU 1306-14

PRÄPARIERSCHEREN
DISSECTING SCISSORS



Metzenbaum
14,5 cm / 5¾"
gebogen / curved
RU 1311-14

SUPERCUT



Metzenbaum
14,5 cm / 5¾"
gebogen, gezahnt
curved, serrated
RU 1311-14 MC



Metzenbaum
14,5 cm / 5¾"
gebogen / curved
RU 1314-14

Tc



Metzenbaum-Fino
14,5 cm / 5¾"
gebogen / curved
RU 1316-14

**PRÄPARIERSCHEREN
DISSECTING SCISSORS**



Metzenbaum
gerade /straight
18 cm /7" **RU 1321-18**
20 cm /8" **RU 1321-20**



Metzenbaum-Fino
18 cm /7"
gerade /straight
RU 1326-18



Metzenbaum-Fino
gebogen /curved
18 cm /7" **RU 1330-18**
20 cm /8" **RU 1330-20**



Metzenbaum
gebogen /curved
18 cm /7" **RU 1331-18**
20 cm /8" **RU 1331-20**

SUPERCUT



**Metzenbaum
Metzenbaum-Fino**

gebogen, gezahnt
curved, serrated

Metzenbaum
18 cm /7" **RU 1331-18 MC**
20 cm /8" **RU 1331-20 MC**

Metzenbaum-Fino
18 cm /7" **RU 1330-18 MC**

PRÄPARIERSCHEREN, FEINE CHIRURGISCHE SCHEREN
DISSECTING SCISSORS, FINE OPERATING SCISSORS

Tc



Metzenbaum
gebogen / *curved*
RU 1334-18
RU 1334-20



Metzenbaum-Fino
gebogen / *curved*
RU 1336-18
RU 1336-20

18 cm / 7"
20 cm / 8"



12 cm / 4¾"
gerade / *straight*
RU 1503-12



12 cm / 4¾"
gebogen / *curved*
RU 1513-12

SUPERCUT



Plastic Surgery
12 cm / 4¾"
gerade, gezahnt
straight, serrated
RU 1503-12 MC

gebogen, gezahnt
curved, serrated
RU 1513-12 MC

FEINE CHIRURGISCHE SCHEREN
FINE OPERATING SCISSORS

SUPERCUT



11,5 cm / 4½"

gerade, gezahnt
straight, serrated
RU 1518-11 MC

gebogen, gezahnt
curved, serrated
RU 1519-11 MC

gerade
straight



Wagner
12 cm / 4¾"



Fig. 1

RU 1521-12



Fig. 2

RU 1522-12



Fig. 3

RU 1523-12

gebogen
curved



Fig. 1

RU 1524-12



Fig. 2

RU 1525-12



Fig. 3

RU 1526-12

FEINE CHIRURGISCHE SCHEREN
FINE OPERATING SCISSORS



Reynolds
gerade / *straight*
RU 1580-15 15 cm / 6"
RU 1580-18 18 cm / 7"



Reynolds
gebogen / *curved*
RU 1581-15
RU 1581-18

SUPERCUT



Reynolds
15 cm / 6"
gerade, gezahnt / *straight, serrated*
RU 1580-15 MC
gebogen, gezahnt / *curved, serrated*
RU 1582-15 MC

SUPERCUT

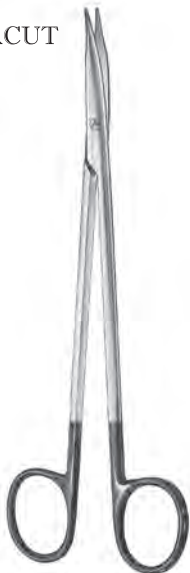

Jameson
gezahnt / *serrated*
15 cm / 6" **RU 1583-15 MC**
18 cm / 7" **RU 1583-18 MC**



Jameson-Werber
13 cm / 5"
gebogen / *curved*
RU 1584-13



Jameson-Werber
15 cm / 6"
gebogen / *curved*
RU 1584-15

FEINE SCHEREN
FINE SCISSORS

SUPERCUT



11,5 cm / 4½"

gerade, gezahnt gebogen, gezahnt
straight, serrated curved, serrated
RU 1630-09 MC **RU 1631-09 MC**
RU 1630-11 MC **RU 1631-11 MC**



9 cm / 3½"
RU 1636-09

RU 1630-09, 10, 11 und /and
RU 1631-09, 10, 11
siehe Seite 62 /see page 62



Baby-Lexer (Knapp)
10 cm / 4"
gerade / straight
RU 1650-10



gebogen / curved
RU 1651-10



gerade / straight
RU 1670-14



Joseph
14 cm / 5½"
gebogen / curved
RU 1671-14

**PRÄPARIERSCHEREN
DISSECTING SCISSORS**



Kilner (Ragnell)

12 cm / 4¾" **RU 1675-12**
 13 cm / 5" **RU 1675-13**
 15 cm / 6" **RU 1675-15**

<p>Tc 12 cm / 4¾" RU 1676-12</p>



Mod. Rudolf
 11 cm / 4½"
 gebogen, gezahnt
 curved, serrated
RU 1676-11 MC

SUPERCUT



Mod. Rudolf
 14 cm / 5½"
 gebogen, gezahnt
 curved, serrated
RU 1676-14 MC

**PRÄPARIERSCHEREN
DISSECTING SCISSORS**

SUPERCUT

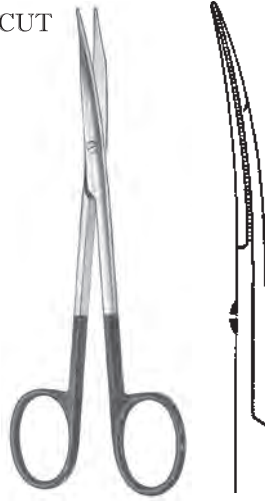

Reynolds
13 cm / 5"
gezahnt / serrated
RU 1677-13 MC

SUPERCUT

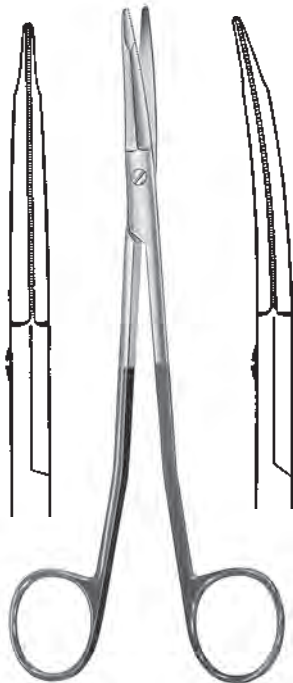

Freeman-Kaye
18 cm / 7"
gerade, gezahnt gebogen, gezahnt
straight, serrated curved, serrated
RU 1680-18 MC RU 1681-18 MC

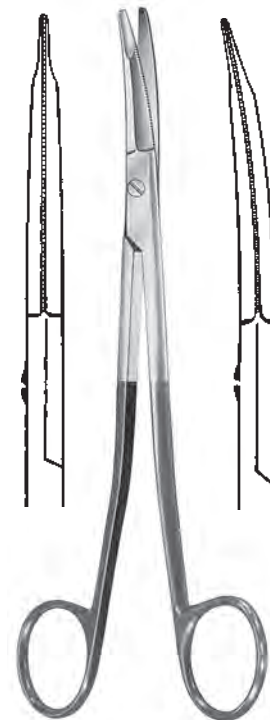

Freeman-Gorney
19 cm / 7½"
gerade, gezahnt gebogen, gezahnt
straight, serrated curved, serrated
RU 1682-19 MC RU 1683-19 MC

**PRÄPARIERSCHEREN
DISSECTING SCISSORS**

SUPERCUT



Gorney
12,5 cm / 5"
gerade / straight
gezahnt / serrated
RU 1688-12 MC



Gorney
12,5 cm / 5"
gebogen / curved
gezahnt / serrated
RU 1689-12 MC

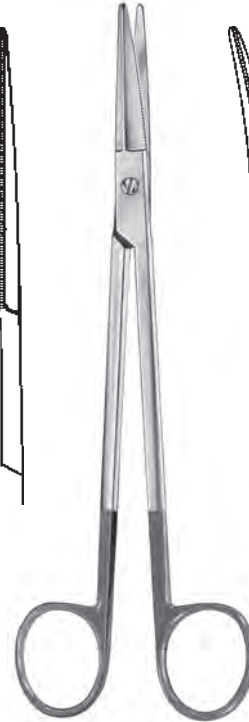

gerade
straight
RU 1688-19 MC



Gorney
19 cm / 7½"
gebogen / curved
curved
RU 1689-19 MC



Freeman
18 cm / 7"
gebogen / curved
RU 1693-18 MC



10 cm / 4½"
RU 1706-10
Speichelgangschere
Salival scissors



Mc Indoe
19 cm / 7½"
RU 1730-19



15 cm / 6"
RU 1792-15
Nerv-Präparierschere
Nerve dissecting scissors

TONSILLENSCHEREN
TONSIL SCISSORS



Böttcher
18 cm / 7" 18 cm / 7"
stumpf / blunt spitz / sharp
RU 1810-18 RU 1811-18



Prince
17,5 cm / 7"
RU 1815-17



Tönnis
18 cm / 7"
gerade / straight
RU 1820-18



Tönnis
18 cm / 7"
gebogen / curved
RU 1821-18



Tönnis-Adson
17,5 cm / 7"
RU 1825-17



Tönnis-Adson
17,5 cm / 7"
RU 1829-17

TONSILLENSCHEREN, NASENSCHEREN
TONSIL SCISSORS, NASAL SCISSORS



Good
19 cm / 7½"
RU 1845-19



Heymann
18 cm / 7"
RU 2115-18

SUPERCUT



Heymann
18 cm / 7"
gezahnt / serrated
RU 2115-18 MC



Heymann
19,5 cm / 7½"
RU 2116-19

**NASENSCHEREN
NASAL SCISSORS**

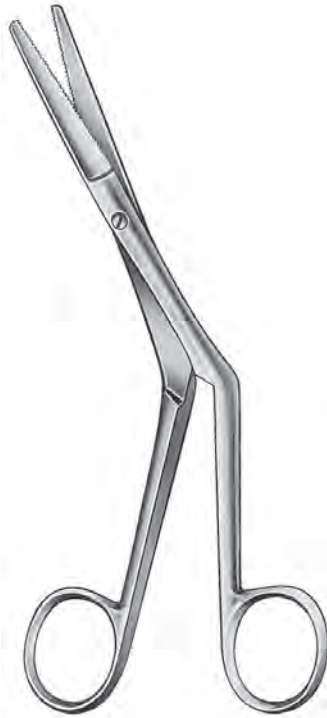

Kirstein
19 cm / 7½"
gezahnt / serrated
RU 2117-18



Cottle-Masing
10,5 cm / 4½"
spitz / sharp stumpf / blunt
RU 2120-10 RU 2121-10



Kilner
11,5 cm / 4½"
gerade, spitz
straight, sharp
RU 2124-11

NASENSCHEREN
NASAL SCISSORS



Fomon
13 cm / 5"
RU 2130-13



Fomon
13 cm / 5"
gezahnt / serrated
RU 2130-13 MC



Fomon
13,5 cm / 5¼"
schlank, gezahnt
delicate, serrated
RU 2131-13

SUPERCUT



Fomon
13,5 cm / 5¼"
schlank, gezahnt
delicate, serrated
RU 2131-13 MC

Tc
RU 2129-13

**NASENSCHEREN
NASAL SCISSORS**



Fomon
13,5 cm / 5¼"
RU 2132-13

SUPERCUT



Fomon
13 cm / 5"
gezahnt / serrated
RU 2132-13 MC



Cottle
16 cm / 6¼"
RU 2135-16



SUPERCUT

Cottle
16 cm / 6¼"
gezahnt / serrated
RU 2135-16 MC



Halle
19 cm / 7½"
RU 2140-19

Tc
RU 2136-16

MIKROSCHEREN
MICRO SCISSORS

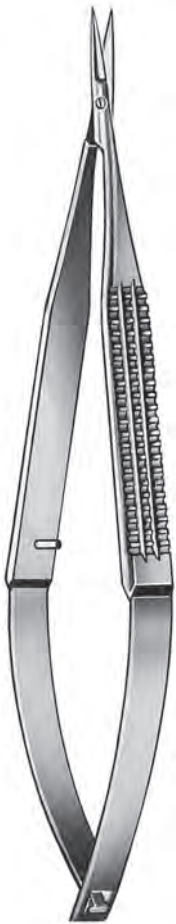

12 cm / 4 $\frac{3}{4}$ "
gerade / *straight*
RU 2370-12

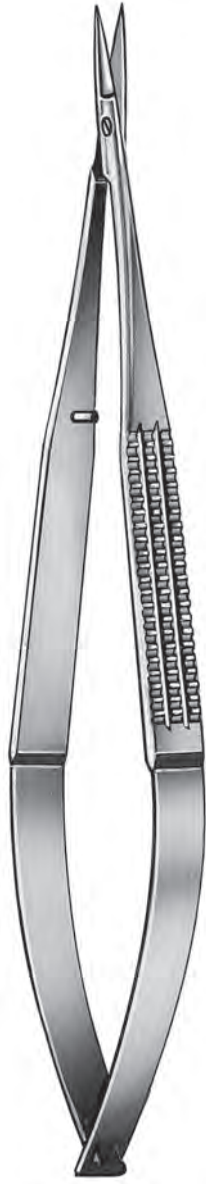

16 cm / 6 $\frac{1}{4}$ "
gerade / *straight*
RU 2370-16

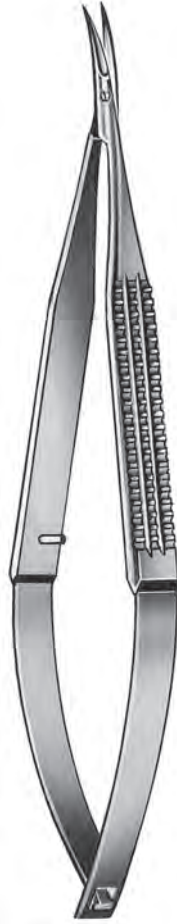

12 cm / 4 $\frac{3}{4}$ "
gebogen / *curved*
RU 2371-12

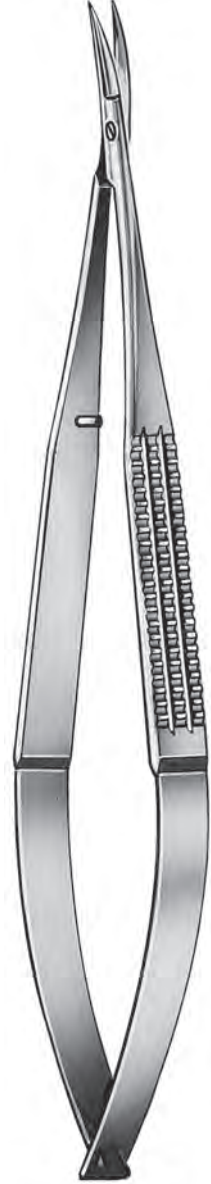

16 cm / 6 $\frac{1}{4}$ "
gebogen / *curved*
RU 2371-16

**MIKROSCHEREN
MICRO SCISSORS**

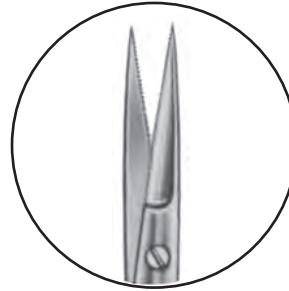

gezahnt
serrated

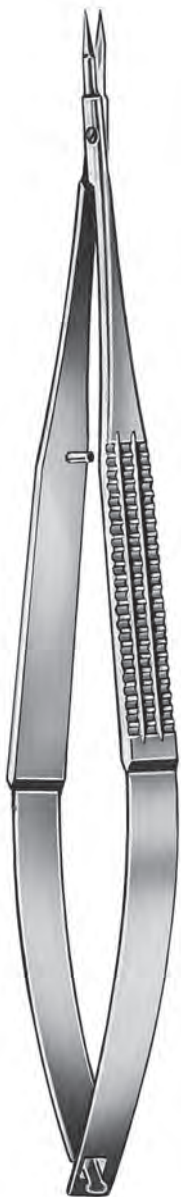

16 cm / 6¼"
gerade / straight
RU 2372-16

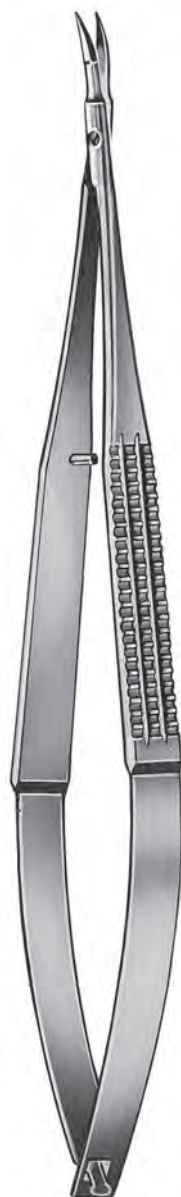

16 cm / 6¼"
gebogen / curved
RU 2373-16

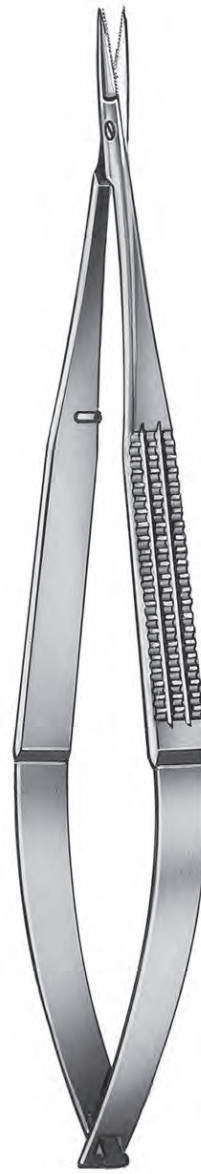

Millesi
16 cm / 6¼"
gerade / straight
RU 2376-16

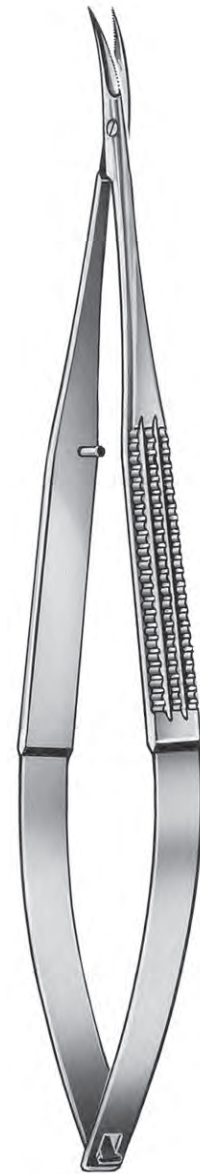

Millesi
16 cm / 6¼"
gebogen / curved
RU 2377-16

FEINE SCHEREN
FINE SCISSORS



	Fino gerade / straight	Fino gebogen / curved
10,5 cm / 4¼"	RU 2418-10	RU 2419-10
11,5 cm / 4½"	RU 2418-11	RU 2419-11



	gerade / straight	gebogen / curved	Fino gerade / straight	Fino gebogen / curved
9,5 cm / 3¾"	RU 2420-09	RU 2421-09	RU 2422-09	RU 2423-09
10,5 cm / 4¼"	RU 2420-10	RU 2421-10	RU 2422-10	RU 2423-10
11,5 cm / 4½"	RU 2420-11	RU 2421-11	RU 2422-11	RU 2423-11

FEINE SCHEREN
FINE SCISSORS

Tc



gerade / straight
RU 2406-11

11,5 cm / 4½"



gebogen / curved
RU 2407-11

SUPERCUT



11,5 cm / 4½"
gerade, gezahnt / gebogen, gezahnt
straight, serrated / curved, serrated
RU 2406-11 MC **RU 2407-11 MC**



Standard

gerade / straight		gebogen / curved
RU 1630-09	9,0 cm / 3½"	RU 1631-09
RU 1630-10	10,5 cm / 4¼"	RU 1631-10
RU 1630-11	11,5 cm / 4½"	RU 1631-11

FEINE SCHEREN
FINE SCISSORS



Stevens



spitz / sharp



stumpf / blunt



SUPERCUT



Stevens

11,5 cm / 4½"

gerade, gezahnt
straight, serrated

gebogen, gezahnt
curved, serrated

RU 2440-11 MC

RU 2441-11 MC

	gerade straight	gebogen curved	gerade straight	gebogen curved
10,5 cm / 4¼"	RU 2430-10	RU 2431-10	RU 2440-10	RU 2441-10
11,5 cm / 4½"	RU 2430-11	RU 2431-11	RU 2440-11	RU 2441-11



Graefe

10,5 cm / 4¼"
RU 2455-10



Wilmer

10 cm / 4"
RU 2457-10



11,5 cm / 4½"

gerade, straight
RU 2460-11

gebogen, curved
RU 2461-11

Strabismusscheren / Strabismus scissors

FEINE SCHEREN
FINE SCISSORS

Tc



11,5 cm / 4½"

gerade
straight
RU 2462-11

Strabismusscheren / *Strabismus scissors*

gebogen
curved
RU 2463-11

SUPERCUT



11,5 cm / 4½"

gerade, gezahnt
straight, serrated
RU 2462-11 MC

Strabismusscheren / *Strabismus scissors*

gebogen, gezahnt
curved, serrated
RU 2463-11 MC



Chadwick
11 cm / 4½"
RU 2470-11



9,5 cm / 3¾"
gerade
straight
RU 2476-02

gebogen
curved
RU 2476-03

LIGATURSCHEREN, DRAHTSCHEREN
LIGATURE SCISSORS, WIRE CUTTING SCISSORS



Littauer
14 cm / 5½"
RU 2500-14



Spencer
9 cm / 3½"
RU 2510-09



Spencer
10,5 cm / 4¼" **RU 2510-10**
12,0 cm / 4¾" **RU 2510-12**



Northbent
12,5 cm / 5"
RU 2520-12



Universal
12 cm / 4¾"
gezahnt / serrated
RU 2600-12



Tc
Universal
12 cm / 4¾"
gezahnt / serrated
RU 2601-12

**VERBANDSCHEREN
BANDAGE SCISSORS**



Universal
14,5 cm / 5¾"
RU 2602-14



Mod. Rudolf
16 cm / 6¼"
RU 2602-16



Universal
18 cm / 7"
RU 2602-18



Harvey
12,5 cm / 5"
gezahnt / serrated
RU 2610-12



Schuknecht
10 cm / 4"
gezahnt / serrated
RU 2615-10



Lister
9,0 cm / 3½" **RU 2650-09**
11,0 cm / 4½" **RU 2650-11**
14,0 cm / 5½" **RU 2650-14**
15,5 cm / 6" **RU 2650-15**
18,0 cm / 7" **RU 2650-18**



Goldmann-Fox
13 cm / 5"
gebogen, gezahnt
curved, serrated
RU 2903-13



Quinby
12 cm / 4¾"
RU 2911-12



11 cm / 4½"
gezahnt / *serrated*
RU 2942-11



9,0 cm / 3½"
10,5 cm / 4¼"

gerade / *straight*
RU 2980-09
RU 2980-10



gebogen / *curved*
RU 2981-09
RU 2981-10

**ARTERIENKLEMMEN
HEMOSTATIC FORCEPS**

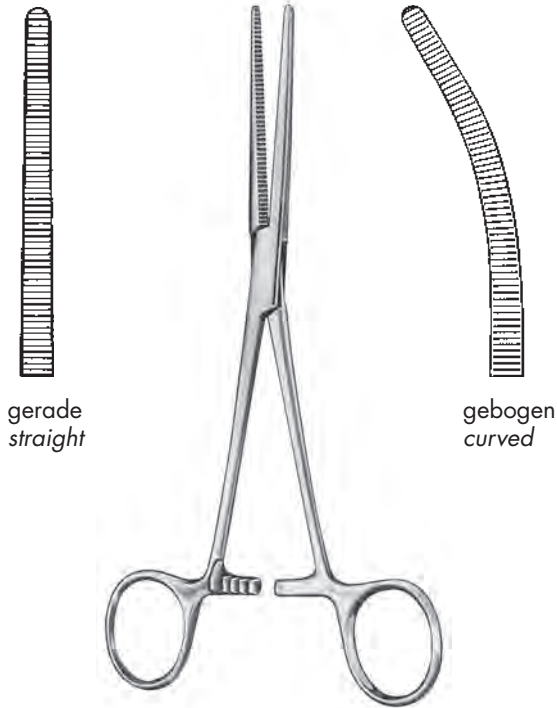

gerade
straight

gebogen
curved

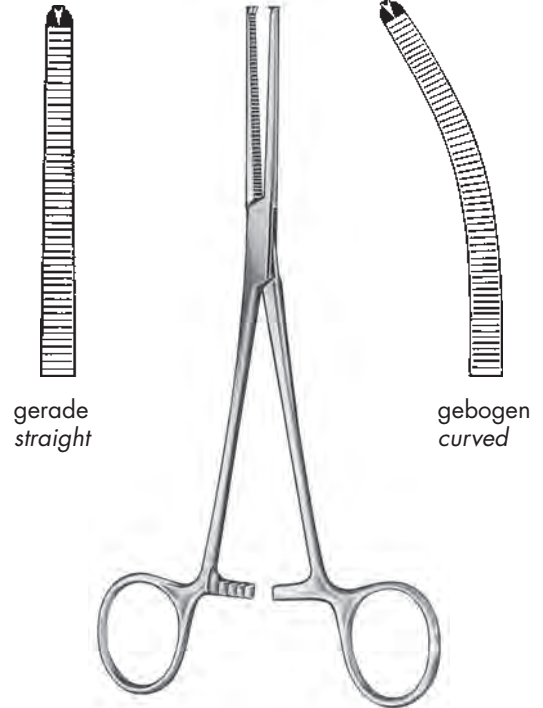

gerade
straight

gebogen
curved

Rochester-Péan			Ochsner-Kocher	
RU 3000-13	RU 3001-13	13 cm / 5"	RU 3010-13	RU 3011-13
RU 3000-14	RU 3001-14	14 cm / 5½"	RU 3010-14	RU 3011-14
RU 3000-16	RU 3001-16	16 cm / 6¼"	RU 3010-16	RU 3011-16
RU 3000-18	RU 3001-18	18 cm / 7"	RU 3010-18	RU 3011-18
RU 3000-20	RU 3001-20	20 cm / 8"	RU 3010-20	RU 3011-20

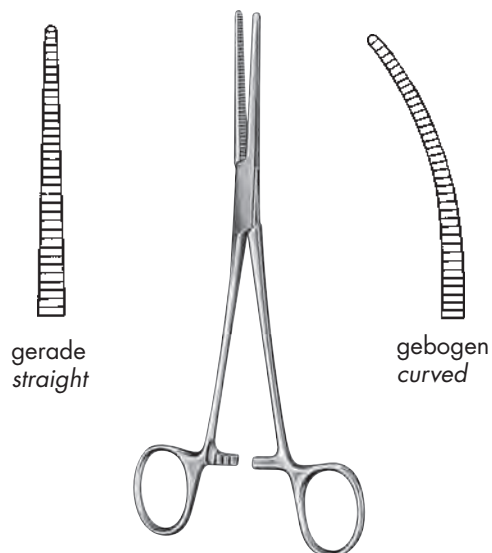

gerade
straight

gebogen
curved

◀ fein
fine ▶

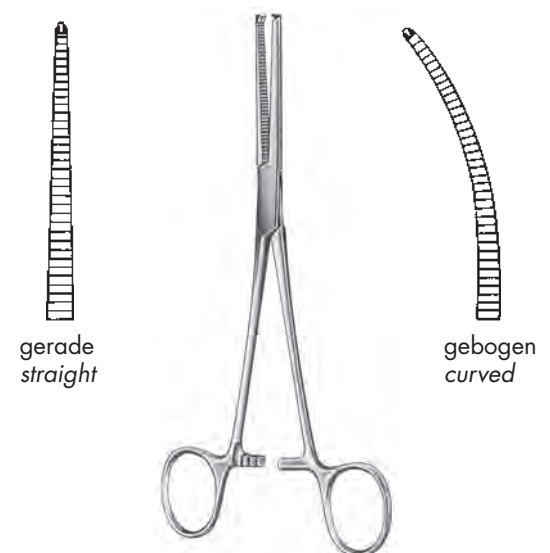

gerade
straight

gebogen
curved

Péan		Kocher		
RU 3020-13	RU 3021-13	13 cm / 5"	RU 3030-13	RU 3031-13
RU 3020-14	RU 3021-14	14 cm / 5½"	RU 3030-14	RU 3031-14

**ARTERIENKLEMMEN
HEMOSTATIC FORCEPS**



Kelly
14 cm / 5½"

Kelly-Rankin
16 cm / 6¼"

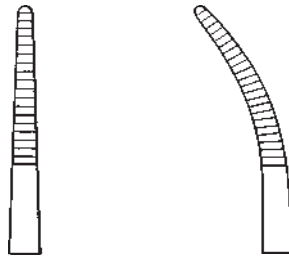

14 cm / 5½"

RU 3050-14

RU 3051-14

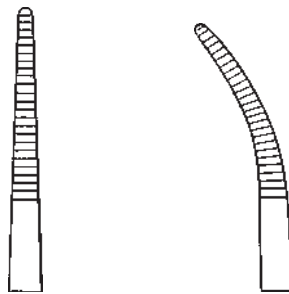

16 cm / 6¼"

RU 3050-16

RU 3051-16



14 cm / 5½"
gerade
straight gebogen
curved

RU 3068-14

RU 3069-14



Crile
14 cm / 5½"

Crile-Rankin
16 cm / 6¼"

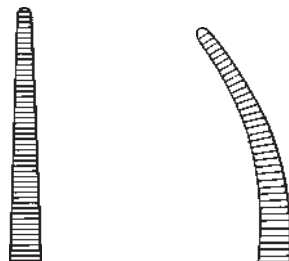

14 cm / 5½"

RU 3070-14

RU 3071-14

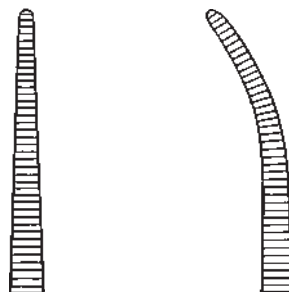

16 cm / 6¼"

RU 3070-16

RU 3071-16

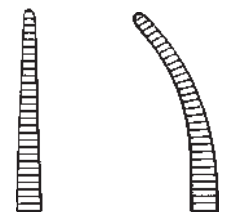

RU 3072-14

RU 3073-14



Baby-Crile
14 cm / 5½"

**ARTERIENKLEMMEN
HEMOSTATIC FORCEPS**



Crile

14 cm / 5½"

Crile-Rankin

16 cm / 6¼"



RU 3074-14

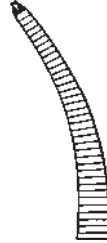

RU 3075-14

14 cm / 5½"



RU 3074-16

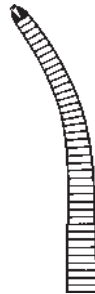

RU 3075-16

16 cm / 6¼"



Baby-Crile

14 cm / 5½"



RU 3076-14



RU 3077-14



Leriche

15 cm / 6"



RU 3080-15



RU 3081-15



RU 3082-15



RU 3083-15



Providence

14 cm / 5½"



RU 3090-14



RU 3091-14

**ARTERIENKLEMMEN
HEMOSTATIC FORCEPS**

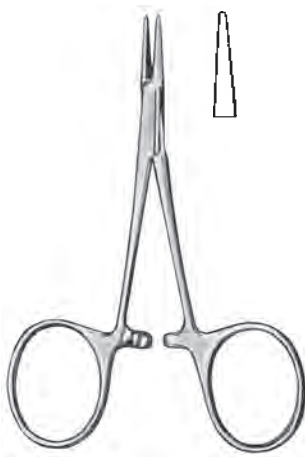

9,5 cm / 3¾"
RU 3097-09
Ligaturklemme, glatt
Ligature forceps, smooth



Halsted-Mosquito
12 cm / 4¾"
14 cm / 5½"

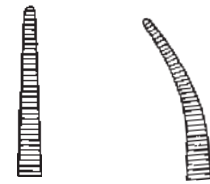

RU 3100-12 RU 3101-12
RU 3100-14 RU 3101-14

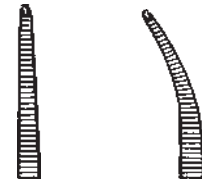

RU 3110-12 RU 3111-12
RU 3110-14 RU 3111-14



Halsted-Mosquito
18 cm / 7"
21 cm / 8¼"



RU 3100-18
RU 3100-21



RU 3101-18
RU 3101-21



RU 3110-18
RU 3110-21

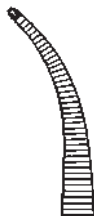

RU 3111-18
RU 3111-21



DeBAKEY



Mosquito
12 cm / 4¾"

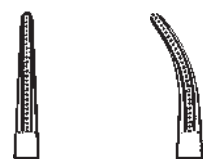

RU 7680-12 RU 7681-12

Atrauma-Arterienklemmen
Atrauma hemostatic forceps

**ARTERIENKLEMMEN
HEMOSTATIC FORCEPS**



Jacobson-Halsted
13 cm / 5"
sehr fein / very fine



RU 3114-13



RU 3115-13



Micro-Mosquito
10 cm / 4"
12 cm / 4¾"



RU 3120-10
RU 3120-12



RU 3121-10
RU 3121-12



RU 3122-10
RU 3122-12



RU 3123-10
RU 3123-12



12 cm / 4¾"
RU 3137-12



Maul kreuzgerieft
Cross serrations



Hartmann
10 cm / 4"



RU 3140-10



RU 3141-10



RU 3142-10



RU 3143-10

**ARTERIENKLEMMEN, TONSILLEN-KLEMMZANGEN
HEMOSTATIC FORCEPS, TONSIL FORCEPS**

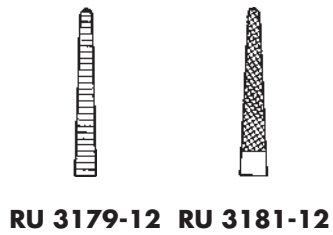
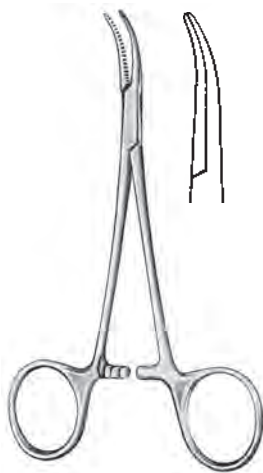

RU 3179-12 RU 3181-12

Mosquito-Dandy
12 cm / 4¾"
seitwärts gebogen
lateral curved

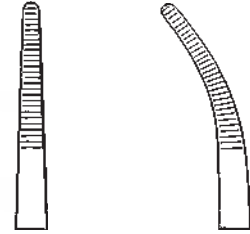

RU 3200-18 RU 3201-18

Adson
18,5 cm / 7¼"

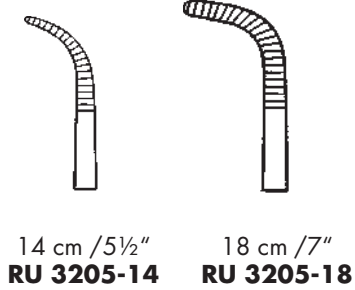

RU 3205-14 RU 3205-18

Baby-Adson

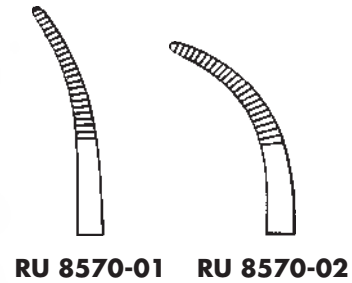

RU 8570-01 RU 8570-02

Schnidt
19 cm / 7½"
Tonsillen-Klemmzange
Tonsil forceps

**ARTERIENKLEMMEN, TONSILLENKLEMMEN
HEMOSTATIC FORCEPS, TONSIL FORCEPS**



Birkett
19 cm / 7½"



RU 3210-19

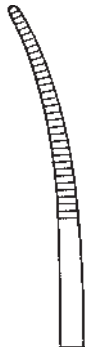

RU 3211-19

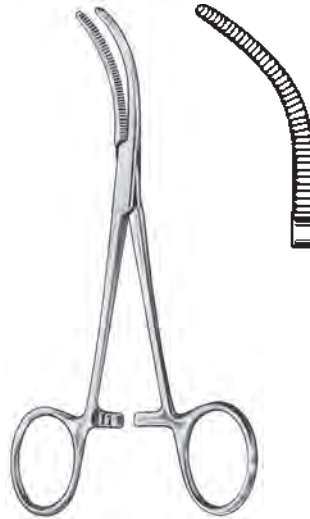

Baby-Overholt
13,5 cm / 5¼"
RU 3289-14



Baby-Mixer
14 cm / 5½" 18 cm / 7"
RU 3328-14 RU 3328-18



Negus
19 cm / 7½"

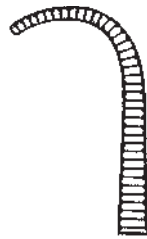

Fig. 1
RU 3387-01



Fig. 2
RU 3387-02



Mikulicz
18,5 cm / 7¼"
RU 3499-18

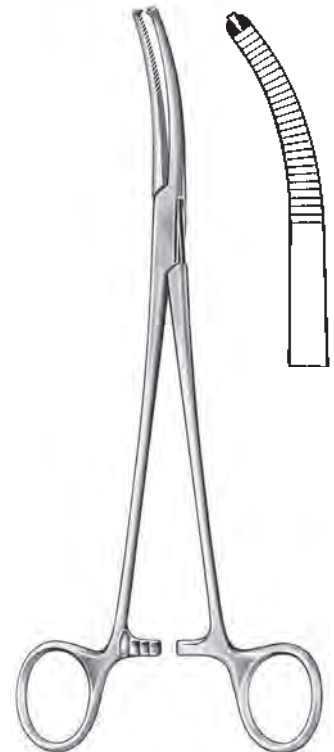

Mikulicz
20 cm / 8"
RU 3501-20

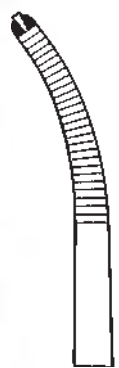

TONSILLENKLEMMEN, TUCHKLEMMEN
TONSIL FORCEPS, TOWEL FORCEPS

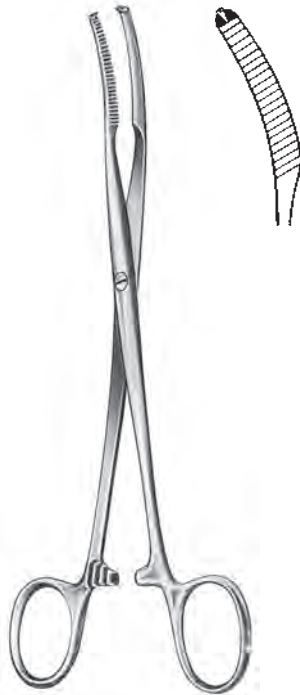

Mikulicz
18 cm / 7"
RU 3504-18

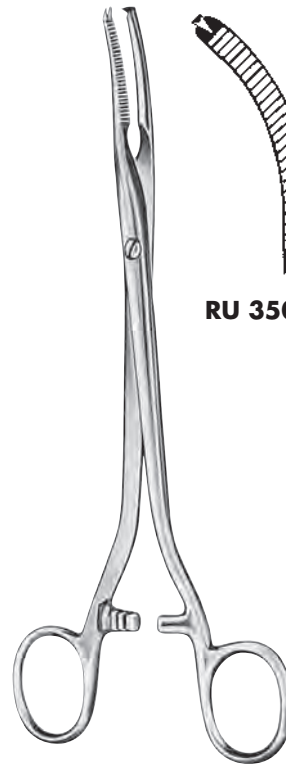

RU 3505-20

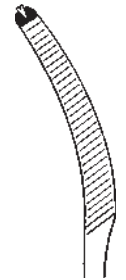

RU 3506-20

Mikulicz
20 cm / 8"



Schädel
9 cm / 3½"
RU 3550-09



Jones
5 cm / 2" **RU 3552-05**
9 cm / 3½" **RU 3552-09**



Backhaus
9 cm / 3½" **RU 3600-09**
11 cm / 4½" **RU 3600-11**
13 cm / 5" **RU 3600-13**
15 cm / 6" **RU 3600-15**

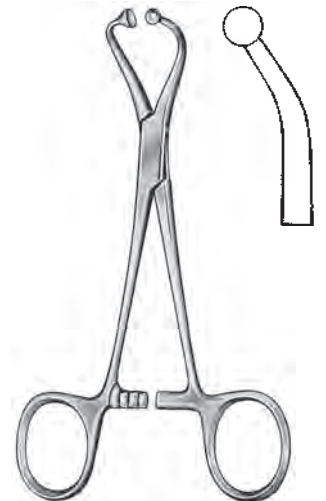

11 cm / 4½" **RU 3617-11**
13 cm / 5" **RU 3617-13**

**KORN-(POLYPEN) ZANGEN, SINUSKLEMMEN
POLYPUUS AND DRESSING FORCEPS, SINUS FORCEPS**

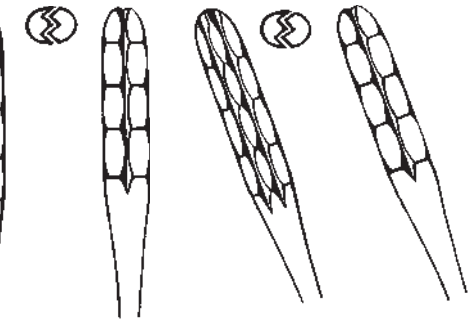
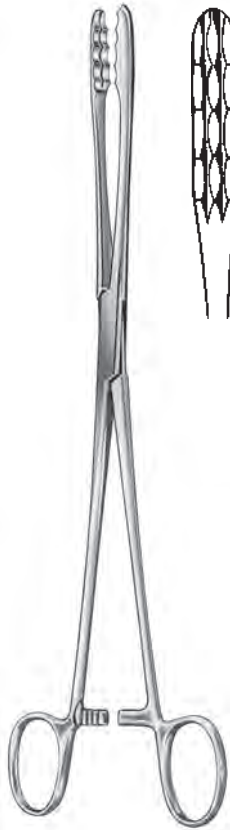

gerade
straight
RU 3800-22

gebogen
curved
RU 3801-22

Ulrich

22 cm / 8¾"



Lister

12,5 cm / 5" **RU 3810-12**
16,0 cm / 6¼" **RU 3810-16**
18,0 cm / 7" **RU 3810-18**
Sinusklemme / Sinus forceps

17,5 cm / 7"
gebogen / curved
RU 3815-17



gerade / straight
20 cm / 8" **RU 3860-20**
25 cm / 10" **RU 3860-25**

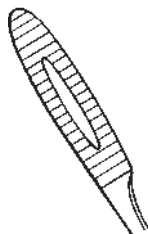

gebogen / curved
20 cm / 8" **RU 3861-20**
25 cm / 10" **RU 3861-25**

Gross-Maier



Duplay

20 cm / 8"
RU 3881-20

BULLDOGKLEMMEN
BULLDOG CLAMPS



De Bakey-Hess
4,5 cm / 1³/₄"
RU 3936-20



De Bakey-Hess
5,5 cm / 2¹/₄"
RU 3936-30



DeBaKEY



RU 7586-07
RU 7586-08

8 cm / 3¹/₈"
9 cm / 3¹/₂"



RU 7587-07
RU 7587-08



23 cm / 9"
RU 7586-00
Anlegezange / Setting forceps

FASSZANGEN
GRASPING FORCEPS



Lahey
15 cm / 6"
RU 6280-15
Kropffasszange
Goitre grasping forceps



Allis
15 cm / 6"
Zähne 4:5 **RU 6500-15**
teeth 5:6 **RU 6502-15**



Czerny
20,5 cm / 8¼"
RU 7175-20



Braun
15,5 cm / 6¼"
RU 7197-16

ANATOMISCHE PINZETTEN
DRESSING FORCEPS

Tc



	Standard	Standard		Engl. Modell	Cottle
10,5 cm / 4¼"	RU 4000-10				
11,5 cm / 4½"	RU 4000-11		RU 4010-11		
13,0 cm / 5"	RU 4000-13		RU 4010-13	RU 4024-13	
14,5 cm / 5¾"	RU 4000-14	RU 4002-14	RU 4010-14		
15,0 cm / 6"	RU 4000-15				RU 4026-15
16,0 cm / 6¼"	RU 4000-16	RU 4002-16	RU 4010-16		
18,0 cm / 7"	RU 4000-18	RU 4002-18	RU 4010-18		
20,0 cm / 8"	RU 4000-20	RU 4002-20	RU 4010-20		
25,0 cm / 10"	RU 4000-25	RU 4002-25	RU 4010-25		

Tc

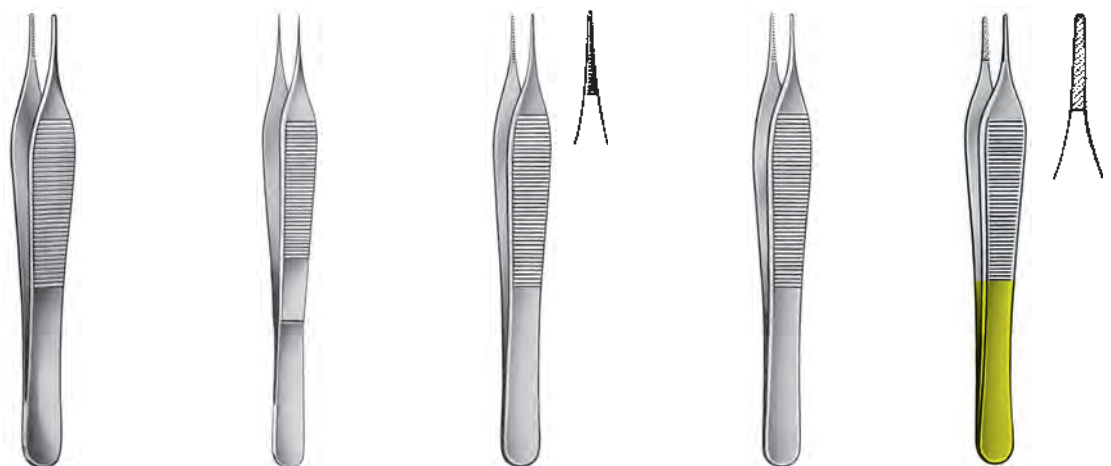

	Ewald	Jacobson-Adson	Mikro-Adson	Adson Standard	Adson
12,0 cm / 4¾"	RU 4032-12	RU 4033-12	RU 4034-12	RU 4035-12	RU 4036-12
15,5 cm / 6"		RU 4033-15	RU 4034-15	RU 4035-15	RU 4036-15

ANATOMISCHE PINZETTEN, TUMORFASSPINZETTEN
DRESSING FORCEPS, TUMOR GRASPING FORCEPS



McIndoe



Semken

Tc



Semken



12 cm / 4¾"	RU 4038-15	RU 4040-12	
15 cm / 6"		RU 4040-15	RU 4042-15



Yasargil



Ø 3 mm

22 cm / 8¾"
24 cm / 9½"

RU 4064-22 /01
RU 4064-24 /01



Ø 5 mm

RU 4064-22 /02
RU 4064-24 /02



Ø 7 mm

RU 4064-24 /03



Ø 3 mm

22 cm / 8¾"

RU 4064-22 /04



Ø 3 mm

RU 4064-22 /05



Ø 5 mm

RU 4064-22 /06



Ø 5 mm

22 cm / 8¾"

RU 4064-22 /07

MIKRO-PINZETTEN
MICRO FORCEPS



12 cm / 4 3/4"
gerade / *straight*
RU 4068-12



12 cm / 4 3/4"
gebogen / *curved*
RU 4069-12



15 cm / 6"
gerade / *straight*
RU 4068-15



15 cm / 6"
gebogen / *curved*
RU 4069-15

MIKRO-PINZETTEN, TUMORFASS-, ANATOMISCHE PINZETTEN
MICRO FORCEPS, TUMOR GRASPING FORCEPS, DRESSING FORCEPS



Gerald
17,5 cm / 7"
RU 4070-17 RU 4071-17



Lazar
15,5 cm / 6"

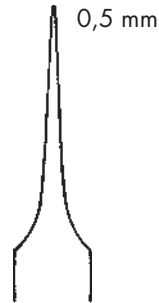

RU 4075-05

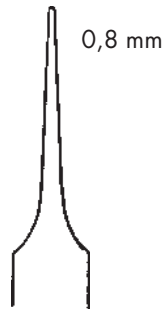

RU 4075-08



3 mm **RU 4078-03**
5 mm **RU 4078-04**

Yasargil
22 cm / 8½"
Maul flach, gezahnt
Jaw flat, serrated



Potts-Smith
18 cm / 7" **RU 4090-18**
21 cm / 8¼" **RU 4090-21**
25 cm / 10" **RU 4090-25**

Tc



Potts-Smith
15 cm / 6" **RU 4092-15**
18 cm / 7" **RU 4092-18**
20 cm / 8" **RU 4092-20**
23 cm / 9" **RU 4092-23**
25 cm / 10" **RU 4092-25**

CHIRURGISCHE PINZETTEN
TISSUE FORCEPS

↔ 1:2



Mc Indoe
15 cm / 6"
RU 4138-15 / 01

↔ 1:2



Gillies
15 cm / 6"
RU 4138-15

↔ 1:2



Semken

12 cm / 4 ³ / ₄ "	RU 4140-12
15 cm / 6"	RU 4140-15

↔ 2:3



Semken

RU 4142-12
RU 4142-15



Derlacki

RU 4143-12



Marschik

15 cm / 6"



Vaugh

RU 4155-15



RU 4155-18

Gerald



RU 4170-18

RU 4171-18

20 cm / 8"

RU 4155-20

22 cm / 8³/₄"

RU 4146-22

RU 4155-25

30 cm / 12"

RU 4155-30

**UHRMACHERPINZETTEN, FEINE PINZETTEN
WATCHMAKER'S FORCEPS, FINE FORCEPS**

0,3 mm



No. 3

11,5 cm / 4½"
RU 4240-03

0,2 mm



No. 4

11 cm / 4½"
RU 4240-04

0,15 mm



No. 5

11 cm / 4½"
RU 4240-05

0,3 mm



No. 6

11 cm / 4½"
RU 4240-06

0,2 mm



No. 7

11,5 cm / 4½"
RU 4240-07

↔ 1:2 0,4 mm



No. 8

11,5 cm / 4½"
RU 4240-08



10,5 cm / 4¼"

RU 4250-10



RU 4251-10



RU 4260-10



RU 4261-10

SPLITTERPINZETTEN, ATRAUMATISCHE PINZETTEN
SPLINTER FORCEPS, ATRAUMATIC TISSUE FORCEPS

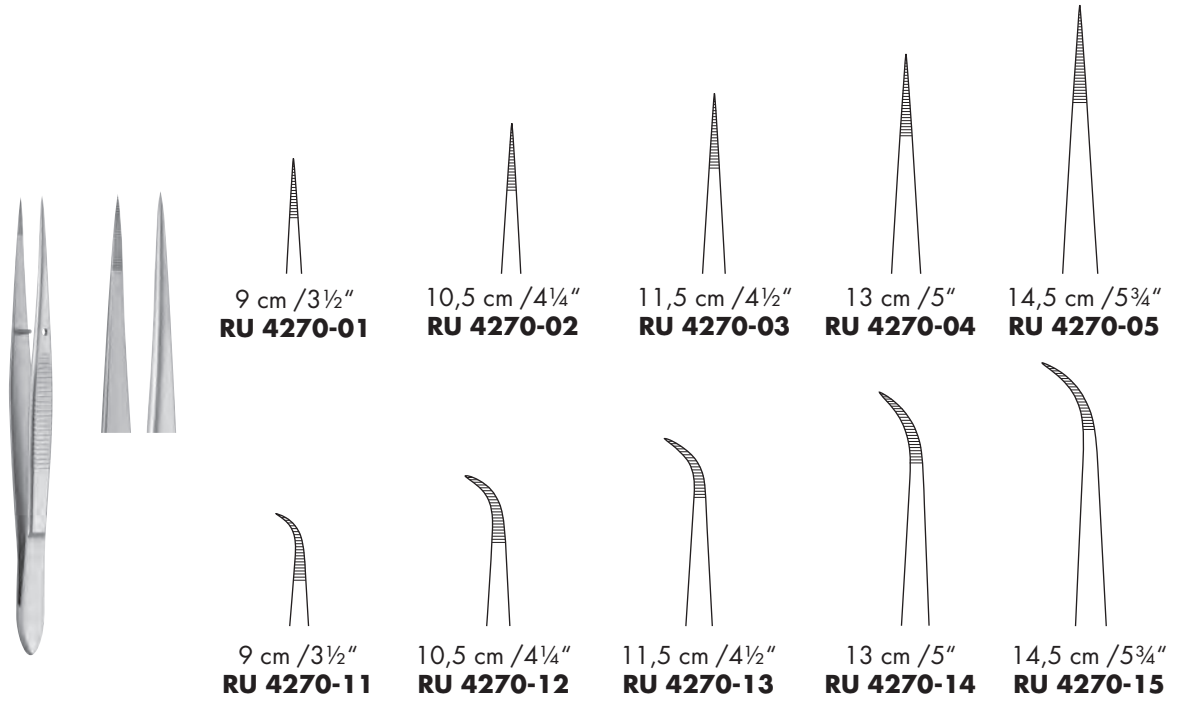

De Bakey

Maulbreite width of jaw	1,5 mm	2,0 mm	2,7 mm
16 cm / 6¼"	RU 7580-16	RU 7581-16	RU 7582-16
20 cm / 8"	RU 7580-20	RU 7581-20	RU 7582-20



De Bakey

2,0 mm
RU 7584-16
RU 7584-20

**ATRAUMATISCHE-, OHR- UND NASENPINZETTEN, BULLDOGKLEMMEN
ATRAUMATIC FORCEPS AND BULLDOG CLAMPS, AURAL AND NASAL FORCEPS**



Adson

12 cm / 4¾" **RU 7585-12**
15 cm / 6" **RU 7585-15**



RU 7586-07

8 cm / 3"



RU 7587-07

RU 7586-08

9 cm / 3½"

RU 7587-08



**Troeltsch
(Wilde)**



Troeltsch



Lucae



1 mm

**Lucae
(Fine)**



Lucae



Cottle

11 cm / 4½"	RU 7860-11				
12 cm / 4¾"	RU 7860-12	RU 7861-12			
14 cm / 5½"			RU 7862-14	RU 7862-14 / 1	RU 7863-14
15 cm / 6"	RU 7860-15				RU 7863-15
18 cm / 7"	RU 7860-18				

NASEN-, COLUMELLA- UND CHIRURGISCHE PINZETTEN
NASAL FORCEPS, COLUMELLA FORCEPS, TISSUE FORCEPS

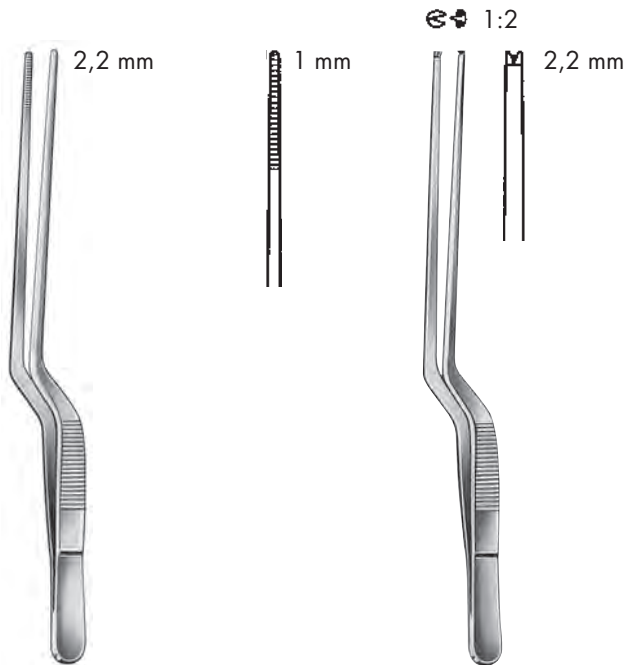

**Jansen
(Gruenwald)**

**Jansen
(Fine)**

Jansen

16 cm / 6¼"	RU 7864-16	RU 7864-16 / 1	RU 7865-16
18 cm / 7"	RU 7864-18	RU 7864-18 / 1	
20 cm / 8"	RU 7864-20	RU 7864-20 / 1	RU 7865-20



Cottle

10 cm / 4"
RU 8312-10



Graefe
11 cm / 4½"

ohne Schloß
without spring catch

RU 9942-11

mit Schloß
with spring catch

RU 9943-11

Zahnbreite 0,5 mm
width of teeth



Castroviejo
10 cm / 4"
RU 9964-05

WUND- UND NERVHÄKCHEN
WOUND AND NERVE HOOKS

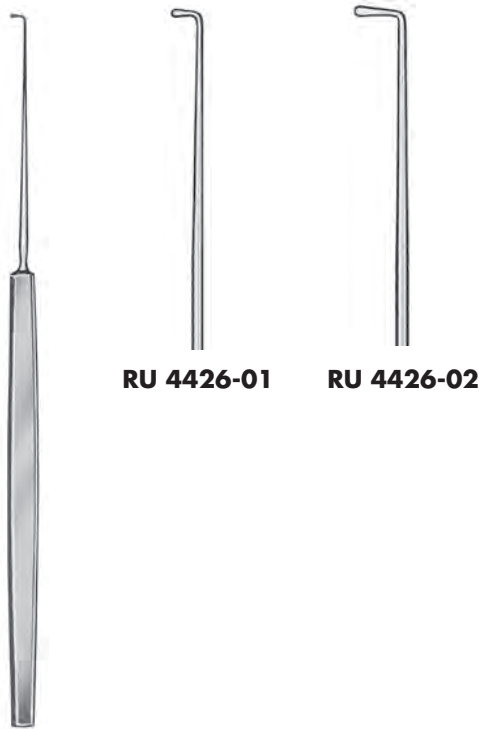

RU 4426-01

RU 4426-02

Cushing
19 cm / 7½"

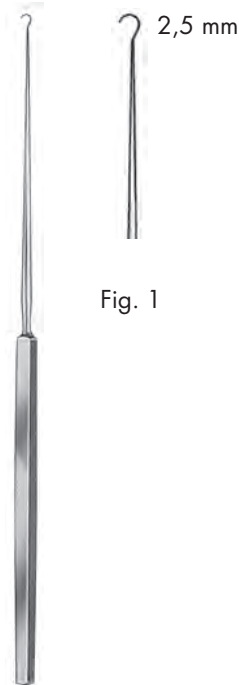

Fig. 1

Gillies
18 cm / 7"
RU 6296-01

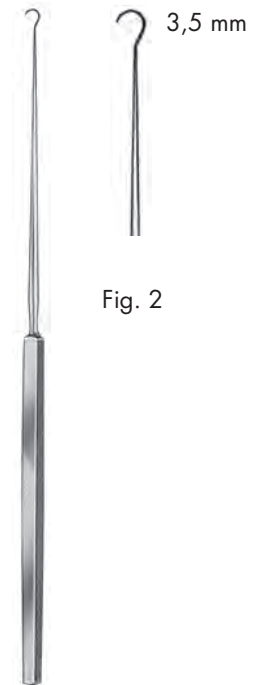
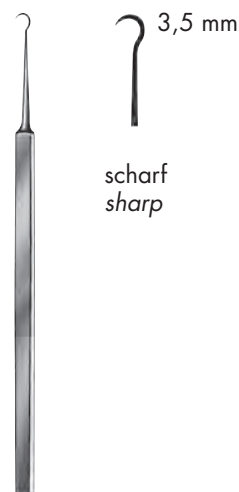

Fig. 2

Gillies
18 cm / 7"
RU 6296-02



Kilner
15 cm / 6"
RU 6297-15



Frazier
RU 6392-13 13 cm / 5"
RU 6392-18 18 cm / 7"

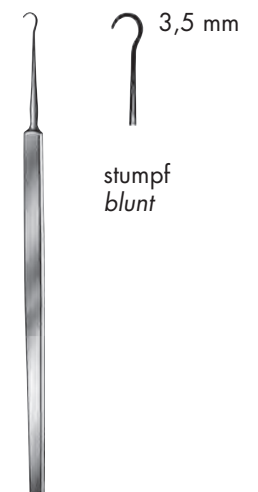

RU 6393-13
RU 6393-18

**WUND-, HAUT- UND TRACHEALHÄKCHEN
WOUND AND TRACHEA HOOKS**

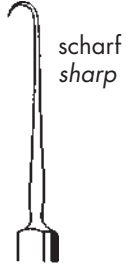
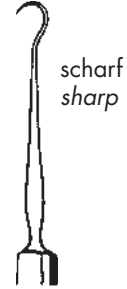
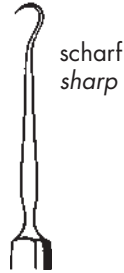

Graefe

12 cm / 4¾"
RU 4430-03/01

12 cm / 4¾"
RU 4430-03/02

12 cm / 4¾"
RU 4430-03/10

12,5 cm / 5"
RU 4430-03/11

O' Connor
12,5 cm / 5"
RU 4430-03/20

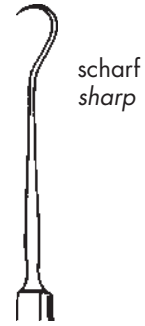
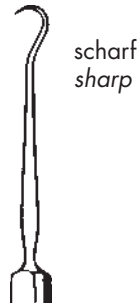

Guthrie

12,5 cm / 5"
RU 4430-03/03

13 cm / 5"
RU 4430-03/04

12 cm / 4¾"
RU 4430-03/12

13 cm / 5"
RU 4430-03/13



13 cm / 5"
RU 4434-13



Kleinert-Kutz
16 cm / 6¼"



RU 4435-03



RU 4435-05



RU 4435-07



Barsky
15 cm / 6"
RU 4436-01 **RU 4436-02**



WUND- UND TRACHEALHÄKCHEN
WOUND AND TRACHEA HOOKS



Humby
11,5 cm / 4½"
RU 4437-00



Lukens
17 cm / 6¾"
RU 4438-17



Jackson
17 cm / 6¾"
RU 4439-17

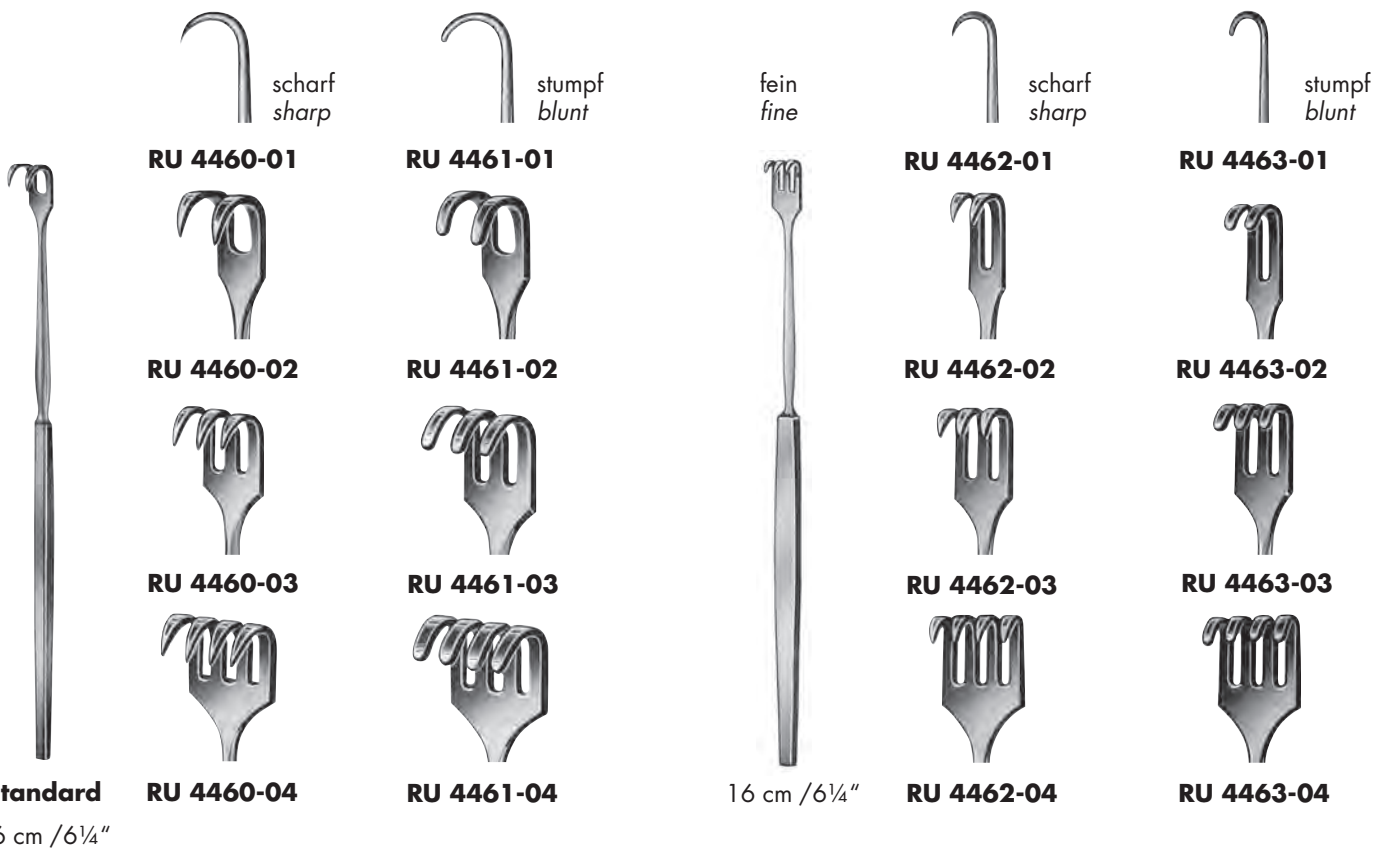

Standard
16 cm / 6¼"

16 cm / 6¼"

WUND-, HAUT- UND TRACHEALHÄKCHEN
WOUND AND TRACHEA HOOKS

flexibel
flexible



16 cm / 6¼"



scharf
sharp

RU 4464-01



stumpf
blunt

RU 4465-01



RU 4464-02



RU 4465-02



RU 4464-03



RU 4465-03



RU 4464-04



RU 4465-04



Jackson
13 cm / 5"
RU 4468-13



Bergmann
14 cm / 5½"
RU 4469-14



Meyerding
18 cm / 7"



18 x 7 mm
RU 4470-01



16 x 5 mm
RU 4470-02



7 x 4 mm
RU 4470-03



10 x 3 mm
RU 4470-04



7 x 4 mm
RU 4470-05



Iterson
16 cm / 6¼"

RU 4471-01

RU 4471-02

TRACHEALHÄKCHEN, WUNDHAKEN
TRACHEA HOOKS, RETRACTORS



scharf
sharp

RU 4472-02



stumpf
blunt

RU 4473-02



RU 4472-03



RU 4473-03



RU 4472-04



RU 4473-04



RU 4472-06



RU 4473-06



Volkmann
11,5 cm / 4½"

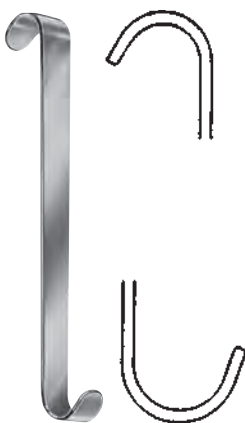

Luer
11 cm / 4½"
RU 4479-11



Rose
13 cm / 5"
RU 4477-13



scharf
sharp

RU 4486-01



stumpf
blunt

RU 4486-02



Senn-Miller
16 cm / 6¼"

**WUNDHAKEN
RETRACTORS**

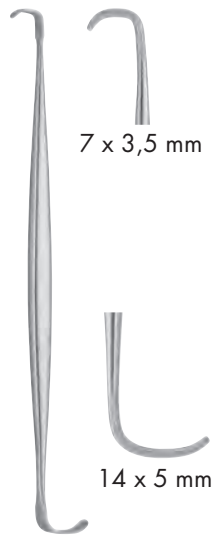

Ragnell-Davis
15 cm / 6"
RU 4488-14



Langenbeck-Green
16 cm / 6¼"



11 x 13 mm
RU 4490-13

16 x 6 mm
RU 4490-16

25 x 6 mm
RU 4490-25



Roux

Satz / set			RU 4492-00
14 cm / 5½"	Fig. 1	21x22 + 29x29 mm	RU 4492-01
15 cm / 6"	Fig. 2	24x26 + 37x35 mm	RU 4492-02
17 cm / 6¾"	Fig. 3	27x29 + 42x35 mm	RU 4492-03



Baby-Roux

13 cm / 5"
RU 4492-13

**WUNDHAKEN
RETRACTORS**

30 x 19 mm



33 x 25 mm
Kilner
15 cm / 6"
RU 4492-19

35 x 29 mm



40 x 35 mm
Kilner
15 cm / 6"
RU 4492-20

30 x 18 mm



25 x 10 mm
Hajek
16,5 cm / 6½"
RU 4492-21



Satz
set

Farabeuf
12 cm / 4¾"
RU 4497-12



Satz
set

Farabeuf
15 cm / 6"
RU 4497-15

**WUNDHAKEN
RETRACTORS**



scharf
sharp

Volkman
22 cm / 8¾"
RU 4500-01

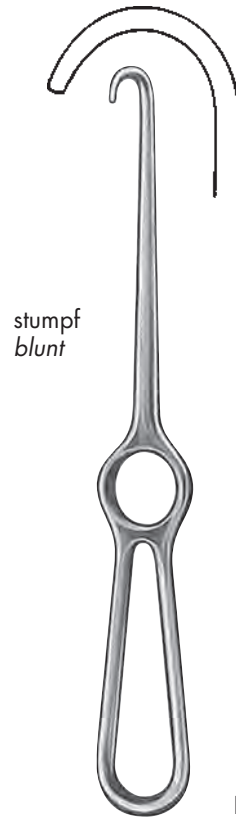

stumpf
blunt

Volkman
22 cm / 8¾"
RU 4501-01



scharf
sharp



stumpf
blunt

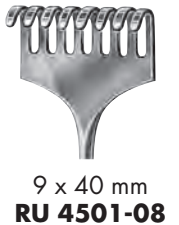

halbscharf
semi-sharp



Volkman
22 cm / 8¾"

**WUNDHAKEN
RETRACTORS**



scharf
sharp

Kocher
21,5 cm / 8½"
RU 4506-11



stumpf
blunt

Kocher
21,5 cm / 8½"
RU 4507-11



30 x 12 mm

Glanz
21 cm / 8¼"
RU 4511-21



Ollier
22,5 cm / 9"



36 x 30 mm
RU 4510-03



36 x 55 mm
RU 4510-04

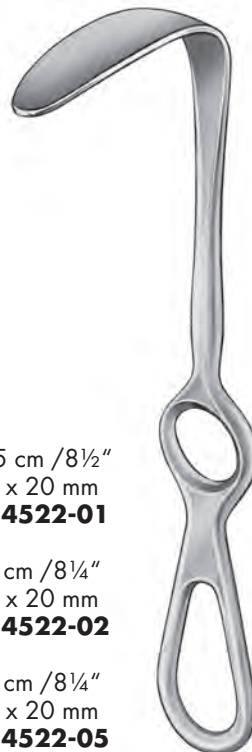

Langenbeck

21,5 cm / 8½"
55 x 20 mm
RU 4522-01

21 cm / 8¼"
63 x 20 mm
RU 4522-02

21 cm / 8¼"
60 x 20 mm
RU 4522-05

21 cm / 8¼"
35 x 7 mm
RU 4523-01

22 cm / 8¾"
35 x 10 mm
RU 4523-02

22 cm / 8¾"
35 x 15 mm
RU 4523-03

23 cm / 8¼"
60 x 20 mm
RU 4523-04



Langenbeck

**WUNDHAKEN
RETRACTORS**



Langenbeck
21 cm / 8¼"

RU 4530-01	30 x 11 mm	RU 4531-01
RU 4530-02	30 x 14 mm	
RU 4530-03	33 x 14 mm	
RU 4530-04	30 x 16 mm	
RU 4530-05	40 x 11 mm	RU 4531-05
RU 4530-06	42 x 13 mm	RU 4531-06
RU 4530-07	50 x 11 mm	



Langenbeck
22 cm / 8¾"



19 x 12 mm
RU 4536-01

21 x 15 mm
RU 4536-02

Kocher
19 cm / 7½"

25 x 6 mm	RU 4538-11
25 x 8 mm	RU 4538-12
35 x 8 mm	RU 4538-13
35 x 11 mm	RU 4538-14
35 x 15 mm	RU 4538-15
40 x 11 mm	RU 4538-16
55 x 11 mm	RU 4538-17
70 x 14 mm	RU 4538-18
80 x 12 mm	RU 4538-19
80 x 16 mm	RU 4538-20



Kocher-Langenbeck
21,5 cm / 8½"



Middeldorpf



14 x 17 mm
21,5 cm / 8½"
RU 4551-01



20 x 22 mm
22 cm / 8¾"
RU 4551-02



26 x 30 mm
23,5 cm / 9¼"
RU 4551-03

**WUNDSPERRER
RETRACTORS**



Finsen

scharf / sharp stumpf / blunt

5 cm / 2" **RU 4640-05** **RU 4641-05**

7 cm / 2¾" **RU 4640-07** **RU 4641-07**

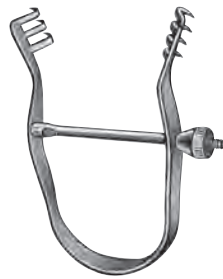

scharf / sharp

RU 4642-07



Allport

9,5 cm / 3¾"

RU 4645-09

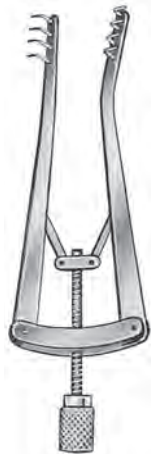

Alm

scharf / sharp stumpf / blunt

7 cm / 2¾" **RU 4650-07** **RU 4651-07**

10 cm / 4" **RU 4650-10** **RU 4651-10**



10 cm / 4"

scharf / sharp stumpf / blunt
RU 4655-01/10 **RU 4655-10**



Jansen

10,5 cm / 4¼"

scharf / sharp stumpf / blunt
RU 4680-10 **RU 4681-10**

**WUNDSPERRER, KIEFERHÖHLENSPERRER
RETRACTORS, ANTRUM RETRACTORS**

**Kieferhöhlensperrer
Antrum retractor**



rechtes Blatt voll,
scharf gezahnt
*solid blade right
coarse serrated*



Perkins
13 cm / 5"
RU 4688-01



linkes Blatt voll,
scharf gezahnt
*solid blade left
coarse serrated*



Perkins
13 cm / 5"
RU 4688-02



Plester
11 cm / 4½"
RU 4690-01

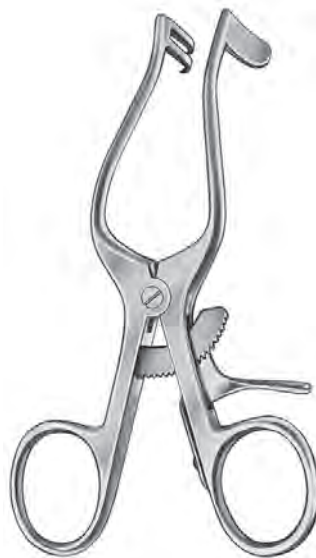

Plester
11 cm / 4½"
RU 4690-02

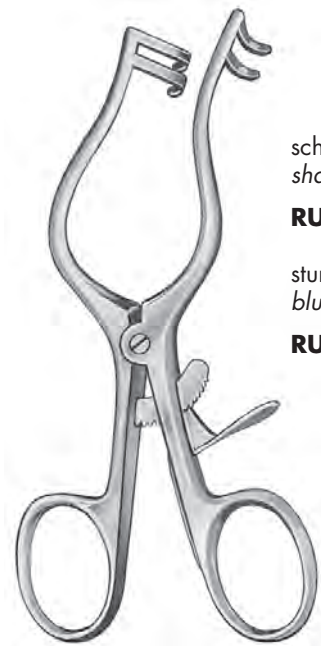

scharf
sharp
RU 4691-01

stumpf
blunt
RU 4691-02

Plester
13 cm / 5"

**KIEFERHÖHLENSPERRER, WUNDSPERRER
ANTRUM RETRACTORS, RETRACTORS**

verstellbar / adjustable

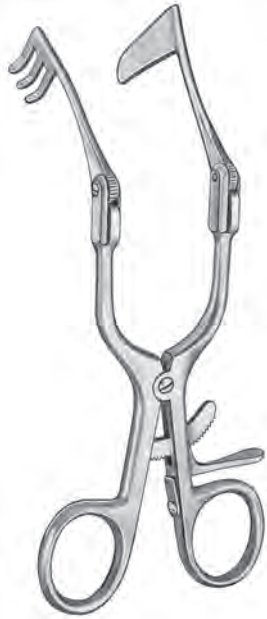

17 cm / 6¾"

Blatt / blade
25 x 17 mm **RU 4694-05**
35 x 17 mm **RU 4694-07**



17 cm / 6¾"

RU 4694-06
RU 4694-08



Fisch

17 cm / 6¾"
RU 4694-11



Weitlaner

scharf stumpf
sharp blunt

10,5 cm / 4¼" **RU 4700-10 RU 4701-10**



Weitlaner

scharf stumpf
sharp blunt

RU 4700-13 RU 4701-13
RU 4700-16 RU 4701-16



Weitlaner-Wullstein

scharf stumpf
sharp blunt

RU 4710-13 RU 4711-13
RU 4710-16 RU 4711-16

13,0 cm / 5"
16,5 cm / 6½"

**WUNDSPERRER
RETRACTORS**



Bellucci
13 cm / 5"
RU 4713-13



Mollison
15 cm / 6"
RU 4714-15



Henley
16,5 cm / 6½"
scharf / sharp stumpf / blunt
RU 4718-00 **RU 4718-01**
komplett mit 3 Mittelvalven
complete with 3 central blades



16 x 19 mm
RU 4718-19



16 x 25 mm
RU 4718-25



16 x 32 mm
RU 4718-32

Mittelvalven, allein
Central blades, only

**WUNDSPERRER, WANGEN- UND LIPPENHALTER
RETRACTORS, CHEEK AND LIP RETRACTOR**



Weitlaner-Baby
13 cm / 5"
RU 4719-13

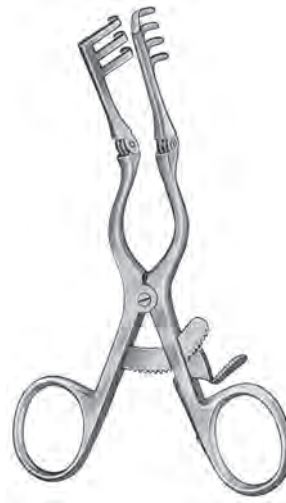

**Cone
(Adson-Baby)**
13 cm / 5"
verstellbar / adjustable
scharf / sharp stumpf / blunt
RU 4722-13 RU 4723-13



19 cm / 7½"
RU 8420-19
Wangen- und Lippenhalter
Cheek and lip retractors

SKALPELLGRIFFE
SCALPEL HANDLES



No. 3
RU 4850-03



No. 4
RU 4850-04



No. 7
RU 4850-07



No. 8
RU 4850-08



No. 9
RU 4850-09

**SKALPELLGRIFFE
SCALPEL HANDLES**



No. 3 L
RU 4850-31



No. 4 L
RU 4850-41

**SKALPELLKLINGEN
SCALPEL BLADES**

Packung à 100 Stk.
Package of 100 pcs.



unsteril / non-sterile
steril / sterile

Fig. 10	Fig. 11	Fig. 12	Fig. 13	Fig. 15
RU 4851-10	RU 4851-11	RU 4851-12	RU 4851-13	RU 4851-15
RU 4852-10	RU 4852-11	RU 4852-12	RU 4852-13	RU 4852-15

passend zu den Griffen /for handles: RU 4850-03, RU 4850-07, RU 4850-31

Packung à 100 Stk.
Package of 100 pcs.



unsteril / non-sterile
steril / sterile

Fig. 18	Fig. 19	Fig. 20	Fig. 21
RU 4851-18	RU 4851-19	RU 4851-20	RU 4851-21
RU 4852-18	RU 4852-19	RU 4852-20	RU 4852-21

passend zu den Griffen /for handles: RU 4850-04, RU 4850-08, RU 4850-09, RU 4850-41

Packung à 100 Stk.
Package of 100 pcs.



unsteril / non-sterile
steril / sterile

Fig. 22	Fig. 23	Fig. 24	Fig. 25
RU 4851-22	RU 4851-23	RU 4851-24	RU 4851-25
RU 4852-22	RU 4852-23	RU 4852-24	RU 4852-25

passend zu den Griffen /for handles: RU 4850-04, RU 4850-08, RU 4850-09, RU 4850-41

MINI-KLINGEN, SKALPELLGRIFFE
MINI BLADES, SCALPEL HANDLES

Packung à 10 Stk.
Package of 10 pcs.
steril /sterile



Fig. 64
RU 4853-64



Fig. 65
RU 4853-65



Fig. 67
RU 4853-67



Fig. 69
RU 4853-69



13,5 cm /5½"
RU 4853-01



15,5 cm /6"
RU 4853-02



10 cm /4"
13 cm /5"
15 cm /6"
RU 4853-33
RU 4853-34
RU 4853-35

Griff für Mini-Skalpellklingen
Handle for mini scalpel blades

SKALPELLGRIFFE FÜR MINI-KLINGEN
SCALPEL HANDLES FOR MINI BLADES



Caspar
18 cm / 7"
RU 4854-03



20 cm / 8"
RU 4854-04



Landolt
21 cm / 8¼"
RU 4854-10



Landolt
25 cm / 10"
RU 4854-11

FISTELMESSER, RASIERKLINGEN UND -HALTER
FISTULA KNIVES, RAZOR BLADES AND -HOLDERS



Simon
20 cm / 8"



Fig. 1

RU 4870-01



Fig. 2

RU 4870-02



RU 4874-00

Packung à 10 Klingen
Package of 10 blades



Castroviejo

Ø 8 mm
13 cm / 5"

RU 4878-13

SONDEN, PFLASTERSPATEL, WATTETRÄGER
PROBES, PLASTER SPATULAS, COTTON APPLICATORS



Ø 1,0 mm Ø 1,5 mm

11,5 cm / 4½"	RU 4900-11	RU 4901-11	RU 4910-11	
13,0 cm / 5"	RU 4900-13	RU 4901-13	RU 4910-13	RU 4914-13
14,5 cm / 5¾"	RU 4900-14	RU 4901-14	RU 4910-14	RU 4914-14

Stacke

Ø 1,0 mm
10,5 cm / 4¼"
RU 4916-10

Lange

18 cm / 7"
RU 4919-01

Pflasterspatel
Plaster spatulas



13 cm / 5"
RU 4920-13



Hartmann
22 cm / 8½"
RU 4921-01



Pelteson
23 cm / 9"
RU 4921-23



Fein
28 cm / 11"
RU 4922-28



Killian
25 cm / 10"
RU 4922-50

SONDEN UND DILATATOREN
PROBES AND DILATORS



Seiffert
18 cm / 7"
Ø 0,5 mm
RU 4924-18

Speichelgangsonde aus Silber
Salival probe
silver



Killian
16,5 cm / 6½"
Ø 1,5 mm
RU 4927-01



13 cm / 5"
Ø 1,5 mm
RU 4927-02



Siebenmann
18 cm / 7"
RU 4928-18



Wilder
9,5 cm / 3¾"
RU 9630-01



Wilder
9,5 cm / 3¾"
RU 9630-02



Wilder
9,5 cm / 3¾"
RU 9630-03

Fig.	Bowman
0000 / 000	RU 9651-04
000 / 00	RU 9651-03
00 / 0	RU 9651-02
0 / 1	RU 9651-01
1 / 2	RU 9651-12
2 / 3	RU 9651-23
3 / 4	RU 9651-34
4 / 5	RU 9651-45
5 / 6	RU 9651-56
6 / 7	RU 9651-67
7 / 8	RU 9651-78



Fig.	Bowman
0000 / 000	RU 9652-04
000 / 00	RU 9652-03
00 / 0	RU 9652-02
0 / 1	RU 9652-01
1 / 2	RU 9652-12
2 / 3	RU 9652-23
3 / 4	RU 9652-34
4 / 5	RU 9652-45
5 / 6	RU 9652-56
6 / 7	RU 9652-67
7 / 8	RU 9652-78



WATTETRÄGER
COTTON APPLICATORS



Universal

	Ø 1,2 mm	Ø 1,5 mm	Ø 1,7 mm
12,5 cm / 5"	RU 4930-12		RU 4932-12
16,0 cm / 6¼"	RU 4930-16		RU 4932-16
18,0 cm / 7"		RU 4931-18	RU 4932-18



Jobson-Horne
18 cm / 7"
RU 4933-02 / 18



Frohn



spiralförmig
spiral threads



Frohn

	Ø 1,0 mm	Ø 1,0 mm
12 cm / 4¾"	RU 4934-01	RU 4934-11
14 cm / 5½"	RU 4934-02	RU 4934-12
16 cm / 6¼"	RU 4934-03	RU 4934-13

WATTETRÄGER, MESSINSTRUMENTE
COTTON APPLICATORS, MEASURING INSTRUMENTS



**Farell
(Farell-Lathbury)**

rund
round
•

dreikant
triangular
▲



Mod. Rudolf

rund
round
•

dreikant
triangular
▲

				Ø 1,2 mm	Ø 1,5 mm	Ø 1,5 mm
12 cm / 4¾"				RU 4937-12	RU 4938-12	RU 4939-12
14 cm / 5¾"	Ø 0,9 mm	RU 4935-14	RU 4936-14	RU 4937-14	RU 4938-14	RU 4939-14
16 cm / 6¼"	Ø 1,1 mm	RU 4935-16	RU 4936-14	RU 4937-16	RU 4938-16	RU 4939-16
18 cm / 7"				RU 4937-18	RU 4938-18	RU 4939-18

graduiert mm: in
graduated mm: in



10 cm / 4"
15 cm / 6"
20 cm / 8"

RU 5104-10
RU 5104-15
RU 5104-20



Townley
10 cm / 4"
RU 5114-10

F. O. OTOSKOPE
F. O. OTOSCOPE

HEINE BETA 200® F. O. Otoskop

Solide Ganzmetallkonstruktion mit Fiberglas-Beleuchtung. Großflächiges Sichtfenster. Gebläse-Anschluss. Xenon /Halogen-Beleuchtung. Völlig luftdichter Abschluss der kratzfesten Schwenklupe. Vergrößerung: ca. 3fach.

Distale Fiberoptik-Beleuchtung mit HEINE XHL®-Halogenlampe

- ▶ helle, schattenfreie Ausleuchtung ohne Reflexe



HEINE BETA 200® F. O. Otoloscope

Solid, all-metal construction. A quality instrument for the physician's office with fiber optics illumination. Large viewing-window. Insufflation port. The scratch-resistant swivel window features an airtight seal. Magnification: ca. 3x.

Distal fiber optics illumination with HEINE XHL® halogen bulb

- ▶ bright, shadow-free light without reflections

F. O. Otoloscope

2, 5 V Halogen
RU 5126-10

3, 5 V Halogen
RU 5126-11

Ersatzlampe
Spare bulb

2, 5 V Halogen
RU 5126-50

3, 5 V Halogen
RU 5126-51



Ø 2,4 mm

RU 5126-36
schwarz / black



Ø 3,0 mm

RU 5126-37



Ø 4,0 mm

RU 5126-38



Ø 5,0 mm

RU 5126-39

1 Satz Dauergebrauchstrichter (4 Stk.)
1 Set (4 pcs.), reusable

RU 5126-40

Einweg-Trichter (grau) 1000er Karton
Disposable tips (grey) 1000 in box
für Kinder /for children 2,5 mm

RU 5126-45

für Erwachsene /for adults 4,0 mm

RU 5126-46



Set komplett mit BETA 200® F. O. Otoskop

1 Satz Dauergebrauchstrichter, 10 Einmalgebrauchstrichter, Ersatzlampe, im Hartschalenetui mit:

Set complete with BETA 200® F. O. otoscope

1 set of reusable tips, 10 disposable tips, spare bulb, in hard shell case with:

Satz / Set



Batteriegriff
(ohne Batterien)
Battery handle
(without batteries)
2,5 V Halogen

RU 5126-20



Akkugriff
Rechargeable handle
3,5 V Halogen

RU 5126-21



Akkugriff
mit Ladegerät, 3,5 V
Rechargeable handle
with charger, 3,5 V

RU 5126-22

HEINE BETA 100® Diagnostik-Otoskop

Ein neues Diagnostik-Otoskop mit direkter Xenon /Halogenbeleuchtung, mit elegantem Ganz-metallgehäuse. Extrem vielseitig mit Anschluss für Nasenspekulum und Spreizspekulum für leichtes Instrumentieren. Das große Sichtfenster mit ca. 3x-Vergrößerung ist aus kratzfestem, optischem Glas. Das Kopfstück ist innen schwarz mattiert, um Reflexe zu eliminieren.

HEINE BETA 100® Diagnostic-Otoscope

A new, diagnostic otoscope with direct halogen illumination in an elegant all-metal instrument head. Extremely versatile in combination with nasal- and spreadable specula for easy instrumentation. Large viewing window, with ca. 3 x magnification, made of scratch-resistant optical glass. The instrument head is mat black inside to eliminate reflections.

**Beta 100® Otoskop Ersatzlampe
Otoscope Spare bulb**

2,5 V Halogen
RU 5127-10

2,5 V Halogen
RU 5127-50

3,5 V Halogen
RU 5127-11

3,5 V Halogen
RU 5127-51



Ø 2,2 mm

RU 5127-34



Ø 2,8 mm

RU 5127-35



Ø 3,5 mm

RU 5127-36



Ø 4,5 mm

RU 5127-37



Ø 5,5 mm

RU 5127-38



Ø 10,0 mm

RU 5127-39

1 Satz Dauergebrauchs-Trichter (6 St.) 5 Ohrtrichter, 1 Nasentrichter
1 Set reusable tips (6 pcs.) 5 ear specula, 1 nose speculum

RU 5127-40

Einweg-Trichter (grau) 1000er Karton
Disposable tips (grey) 1000 in box
für Kinder /for children 2,5 mm

RU 5127-45

für Erwachsene /for adults 4,0 mm

RU 5127-46



Set komplett mit BETA 100® Diagnostik-Otoskop

1 Satz Dauergebrauchstrichter, 10 Einmalgebrauchstrichter, Ersatzlampe, im Hartschalenetui mit:

Set complete with BETA 100® Diagnostic otoscope

1 set of reusable tips, 10 disposable tips, spare bulb, in hard shell case with:

Satz /Set



Batteriegriff
(ohne Batterien)
Battery handle
(without batteries)
2,5 V Halogen

RU 5127-20



Akkugriff
Rechargeable handle
3,5 V Halogen

RU 5127-21



Akkugriff
mit Ladegerät, 3,5 V
Rechargeable handle
with charger, 3,5 V

RU 5127-22

STROMQUELLEN, KOMBINIERTE DIAGNOSTIK-SETS
POWER SUPPLIES, COMBINED DIAGNOSTIC SETS

Der BETA® R 3,5 V Griff wird, nach Abschrauben der Schutzkappe, direkt in der Steckdose aufgeladen.
The BETA® R 3.5 V handle can be charged directly in the main socket or outlet after unscrewing the cap.

Vollautomatische Ladung mit Überladeschutz. Zwei Griffe können unabhängig voneinander in einem Ladegerät geladen werden.
This handle /charger system features fully automatic charging with overcharge protection. Two handles can be charged independently in one charger.



HEINE BETA® Batteriegriff 2,5 V
Ø 145 x 30 mm
(ohne Batterien)
Battery handle
(without batteries)
RU 5123-50

HEINE BETA® Akkugriff R 3,5 V
Ø 170 x 30 mm
Rechargeable handle
RU 5123-55

HEINE BETA® NT 3,5 V - Griff
Ø 145 x 30 mm
Rechargeable handle
RU 5123-60

Ladebatterie 3,5 V
Rechargeable battery 3.5 V
RU 5123-70

dto. mit Ladegerät
dto. with charger
RU 5123-63



BETA 200® Ophthalmoskop, BETA 100® Diagnostik-Otoskop, 1 Satz Dauergebrauchstrichter, 10 Einmalgebrauchstrichter, gebogener Kehlkopfspiegel mit Zubehör, spreizbares Nasenspekulum, je 1 Ersatzlampe, im Reißverschlussbetui.

Set complete with BETA 200® ophthalmoscope, BETA 100® diagnostic otoscope, 1 Set of reusable tips, 10 disposable tips, curved laryngeal mirror with accessories, spreadable nasal speculum, one spare bulb each, in zipper case.

Set mit Batteriegriff, 2,5 V
(ohne Batterien)
Set with battery handle 2.5 V (without batteries)
RU 5128-20

Set mit Akkugriff, 3,5 V
Set with rechargeable handle 3.5 V
RU 5128-21

Set mit Akkugriff und Ladegerät 3,5 V
Set with rechargeable handle and charger, 3.5 V
RU 5128-22



BETA 200® Ophthalmoskop, BETA 200® F. O. Otoskop, 1 Satz Dauergebrauchstrichter, 10 Einmalgebrauchstrichter, je 1 Ersatzlampe, im Hartschalenetui.

Set complete with BETA 200® ophthalmoscope, BETA 200® F. O. otoscope, 1 Set of reusable tips, 10 disposable tips, one spare bulb each, in hard shell case.

Set mit Batteriegriff, 2,5 V
(ohne Batterien)
Set with battery handle 2.5 V (without batteries)
RU 5128-40

Set mit Akkugriff, 3,5 V
Set with rechargeable handle 3.5 V
RU 5128-41

Set mit Akkugriff und Ladegerät 3,5 V
Set with rechargeable handle and charger, 3.5 V
RU 5128-42

MINI-OTOSKOPE, 2,5 V HALOGEN
MINI OTOSCOPE, 2.5 V HALOGEN



Heine Mini 2000 F. O. Otoskop
komplett mit 4 Dauergebrauchs-Trichter,
RU 5126-36 bis RU 5126-39,
10 Einmalgebrauchs-Trichter,
je 5 Stück,
2,5 mm RU 5126-45 und
4,0 mm RU 5126-46
Mini-Griff in Hartschalenetui.

Heine Mini 2000 F. O. Otoscope
complete with 4 reusable tips,
RU 5126-36 to RU 5126-39,
10 disposable tips,
each 5 pcs.
2.5 mm RU 5126-45 and
4.0 mm RU 5126-46
Mini handle in case

Heine Mini 2000 F. O. Otoskop
wie oben, jedoch mit Mini-Otoskop

Heine Mini 2000 F. O. Otoscope
as above but with mini-otoscope

	schwarz /black	blau /blue	grün /green
F. O. Otoskop komplett F. O. Otoscope complete	RU 5130-02	RU 5130-03	RU 5130-04
Otoskop-Kopf allein Otoscope only	RU 5130-12	RU 5130-13	RU 5130-14
Ersatzlampe /Spare bulb	RU 5127-50		
Otoskop komplett Otoscope complete	RU 5130-22	RU 5130-23	RU 5130-24
Otoskop-Kopf allein Otoscope only	RU 5130-32	RU 5130-33	RU 5130-34
Ersatzlampe /Spare bulb	RU 5130-40		
Mini-Batteriegriff Mini Battery handle only	RU 5130-52	RU 5130-53	RU 5130-54
Hartschalenetui hard shell case	RU 5130-70		

LUPENBRILLE C 2.3 BINOCULAR LOUPE C 2.3

Die ultraleichte Lupenbrille

Arbeitsabstand 340 mm oder 450 mm

Die leichte (46 g), kompakte und bequeme HEINE Lupenbrille C mit 2,3facher Vergrößerung bietet gute Voraussetzungen für präzises und sicheres Arbeiten.

HEINE-Qualität zu einem außergewöhnlich attraktiven Preis.

The ultra-light binocular loupe

Working distance 340 mm or 450 mm

The light weight (46 g), compact and comfortable HEINE Binocular Loupe C offers a 2.3 x magnification and is the ideal tool for professionals, who want to achieve the best results.

HEINE quality at a bargain price.

Geringer Abstand der Optik vom Untersucherauge ergibt extrem großes Sichtfeld

The optics are close to the examiner's eyes to give an exceptionally large field of view

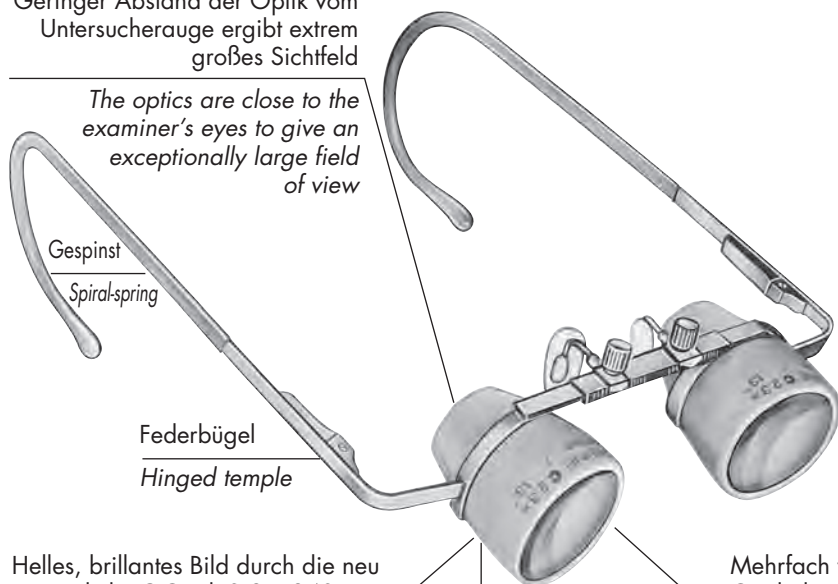

Helles, brillantes Bild durch die neu entwickelte C-Optik 2.3 x 340 mm

Brilliant, high-resolution image with the new C optics 2.3 x 340 mm

Mehrfach vergütete, hochwertige Optik, kratzfest

Multi-coated, scratch-resistant silica glass lenses

Die besonders kompakte Optik erlaubt es, an den Okularen vorbeizusehen, falls erwünscht

Slimline optics – easy to view without magnification if required

Glasklares Sichtschutzvisier

Das Visier wird mit zwei Klammern direkt an der Brillenfassung befestigt.

Clear protective visor

The visor is attached to the loupe frame by two simple clips

RU 5145-70 (12er Pack)



Aufsteckbare Schutzgläser (Paar) Detachable protective lenses (pair)

RU 5145-71



Brillenetui Protective case

RU 5145-72



Technische Daten / Specifications

	RU 5145-34	RU 5145-45
Vergrößerung / magnification	2,3 x	2.3 x
Arbeitsabstand / working distance	340 mm	450 mm
Sichtfeld / field of view	ca. 110 mm	ca. 130 mm
Gewicht / weight	46 g	46 g
PD Einstellung / PD range	50 bis /to 74 mm	
Dioptrie / dioptry	Arbeitsabstand / working distance	
+ 2	440 mm	670 mm
+ 1	390 mm	560 mm
0	340 mm	450 mm
- 1	300 mm	420 mm
- 2	270 mm	370 mm

**STIRNSPIEGEL
HEAD MIRRORS**



Ziegler

mit schwarzem Plastikband
with black head band

Ø 90 mm **RU 5150-09**
Ø 100 mm **RU 5150-10**

mit weißem Plastikband
with white head band

Ø 90 mm **RU 5151-09**
Ø 100 mm **RU 5151-10**

Stirnband, allein
Head band only

schwarz / *black*

RU 5150-20

weiß / *white*

RU 5151-20

Stirnspiegel, allein
Reflector only

Ø 90 mm **RU 5152-09**



Murphy

RU 5150-25

Stirnband aus Zelluloid, weiß, allein
Celluloid head band, white, only

CLAR STIRNLAMPEN CLAR HEADLIGHTS

Clar

Stirnlampe

mit weißem Plastikstirnband
with white plastic head band

RU 5153-00

mit Zelluloidstirnband
with celluloid head band

RU 5154-00

Ersatzspiegel
Spare mirror

RU 5154-80

Ersatz-Schaumgummipolsterung
Spare foam rubber pad

RU 5154-85

Ersatz-Glühbirne
Spare bulb

RU 5154-90



Clar

Stirnlampe Clar F 55

Ergonomischer, gepolsterter Stirnreif; Lichtfokussierung per Drehknopf; leicht wechselbarer Spiegel; 2 m teilbares Kabel mit Bananensteckern, Spiegel Ø 55 mm, 6 Volt

Headlight Clar F 55

Ergonomic headband padded inside; light beam adjustable by control knob; easily replaceable mirror; 2 m divisible cord with banana plugs, mirror Ø 55 mm, 6 Volt

RU 5155-00

Ersatzspiegel
Spare mirror

RU 5155-05

Ersatz-Schaumgummipolsterung
Spare foam rubber pad

RU 5154-85

Ersatz-Glühbirne
Spare bulb

RU 5155-99



Daten zum Trafo entnehmen Sie bitte Seite 124
For transformer please refer to page 124

CLAR STIRNLAMPEN, KALTLICHT-STIRNLAMPEN CLAR HEADLIGHTS, FIBER OPTIC HEADLIGHTS

Clar

Stirnlampe Clar S, 55 mm

Reflektorhohlspiegel Ø 55 mm; verstellbarer ergonomischer Stirnreif; 2 m Zuleitung, Bananenstecker, 6 Volt

Headlight Clar S, 55 mm

Concave mirror Ø 55 mm; adjustable ergonomic headband; 2 m cord with banana plugs, 6 Volt

RU 5155-10

Ersatzspiegel
Spare mirror

RU 5155-15

Ersatz-Glühbirne
Spare bulb

RU 5155-99



Daten zum Trafo entnehmen Sie bitte Seite 124
For transformer please refer to page 124

Clar

Kaltlicht Stirnlampe Clar 73

Klassische HNO-Stirnlampe mit kleinem Spiegelreflektor. Untere Spiegelausbuchtung zur optimalen, monokularen Sicht. Komplett mit 2300mm ultraleichtem F/O-Kabel und ledergepolstertem Stirnreif mit Kopfbügel und zentraler Schnellverstellung. Ohne Adapter für Lichtquelle.

Fiber Optic Headlight Clar 73

Classical ENT-headlight with small mirror. Lower hollow at mirror for optimal, monocular view. Complete with ultra light 2300mm fiber optic light guide and easily adjustable leather bolstered headband with cross band. Without fitting for light source.

RU 5155-20

In der hitzefesten Variante können diese Stirnleuchten auch mit Hochleistungslichtquellen 180 Watt Xenon und 300 Watt Xenon benutzt werden.

Bitte angeben!

The heat resistant model can be used with one of the high power xenon short arc light sources like 180 W Xenon and 300 W Xenon.

Please specify!



STIRNLAMPEN HEADLIGHTS

Stirnlampe nach Jansen

Verstellbare Optik zur Lichtfokussierung; verstellbarer ergonomischer Stirnreif; 2 m Zuleitung, Bananenstecker, 6 Volt.

Headlight by Jansen

Adjustable lens tube for centering the light beam; Adjustable ergonomic headband; 2 m cord, banana plugs, 6 Volt.

RU 5157-10

Ersatz-Glühbirne
Spare bulb

RU 5155-99

Daten zum Trafo entnehmen Sie bitte Seite 124
For transformer please refer to page 124



Xenon kabellose Stirnlampe mit Batteriebox

Helle Stirnlampe mit 6000° K Hochleistungslampe; optimiertes, parabolisches, optisches System mit Fixfokus; Hochleistungs-Miniatur-Xenon-Glühlampe mit integriertem Reflektor; höchste Mobilität durch integrierte Batteriebox für 2 Mignonzellen (AA).

Der schlanke, einstellbare Leuchtenkörper sorgt für ungehinderte Sicht; ergonomischer Stirnreif mit schwarzem Lederpolster.

Xenon cordless headlight with battery box

Very bright Xenon headlight with high power parabolic optical system and fixfocus. Special miniature Xenon incandescent reflector lamp (6000° K), optimised lightspot, mobile use with integrated battery box for 2 AA cells.

The slim lamp body results in an obstacle free view. Ergonomic adjustable headband with black leather bolster.

RU 5157-20 Xenon Stirnlampe mit Batteriebox und 2 x 1,5 V Mignon-Zellen

Xenon headlight with battery box and 2 x 1.5 V batteries, size A 4

RU 5157-21 Ersatzlampe mit Reflektor
Spare lamp with reflector



**KALTLICHT-STIRNLAMPEN
FIBER OPTIC HEADLIGHTS**

RU 5158-20 Miniatur-Stirnleuchte

OP-Version der Miniaturstirnleuchte. Der Faserbündelquerschnitt von 3,5 mm und das 2-fache Linsensystem sorgen für einen kleinen und homogenen Lichtfleck. Lieferung ohne Adapter für Lichtquelle.

Miniature headlight

Operation theatre version of the miniature headlight. The fiber bundle diameter of 3.5 mm as well as the double lens system provide a small and homogenous light spot. Delivery without fitting for light source.

RU 5158-21 Wie 5158-20, jedoch 90° abgewinkeltes Kabelende.

Same as 5128-20 but cable end 90° angled.

RU 5158-40 Miniatur-Stirnleuchte mit Kopfbügelstirnband

Fiberoptische Miniaturstirnleuchte für den OP-Bereich. Maximales Sichtfeld durch Miniatur-Hochleistungs-Optik. Der Faserbündelquerschnitt von 3,5 mm und die verstellbare Kleinoptik mit 2-fachem Linsensystem gewährleisten einen sehr hellen und homogenen Lichtfleck. Das ledergepolsterte Stirnband mit Kopfbügel und zentraler Einhandverstellung sorgt für bequemen Sitz, auch über längere Zeit. Lieferung ohne Adapter für Lichtquelle.

Miniature headlight with cross band headband

Fiber optic miniature headlight for operation theatre. Extra large field of view due to miniature high-performance optic. The fiber bundle of 3.5 mm Ø as well as the adjustable double lens system provide a small and homogenous light spot. The leather bolstered headband with cross band is adjustable centrally with only one hand. It is comfortable also during long period of use. Delivery without fitting for light source.

RU 5158-41 Wie 5158-40, jedoch 90° abgewinkeltes Kabelende.

Same as 5158-40 but cable end 90° angled.



RU 5158-21

In der hitzefesten Variante können diese Stirnleuchten auch mit Hochleistungslichtquellen 180 Watt Xenon und 300 Watt Xenon benutzt werden.

Bitte angeben!

The heat resistant model can be used with one of the high power xenon short arc light sources like 180 W Xenon and 300 W Xenon.

Please indicate!



RU 5158-41

SPANNUNGSQUELLEN POWER SOURCES

Steckernetzteil

- RU 5161-01** Spannungsausgang umschaltbar 4 V /6 V,
max. 1000 mA, 2x Bananenbuchse
- RU 5161-02** Kabel-Zwischenschalter

Wall plug transformer

- RU 5161-01** Output voltages switchable 4 V /6 V,
max. 1000 mA, 2x banana plug
- RU 5161-02** Cord switch

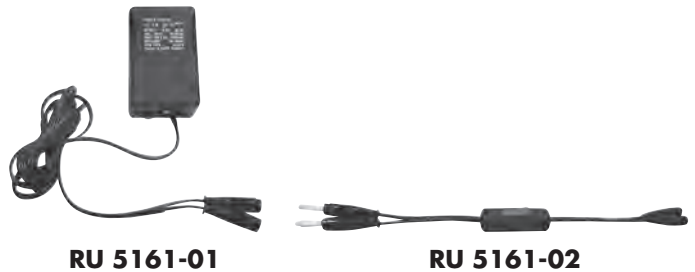

Batteriebox

Batteriebox 6 V für 4 Stk. Babyzelle-Batterien (Typ C),
mit Cinch-Buchse und Schnurschalter.
Spannung kann mit Batterieatrappe auf 4,5 V (1 Stück
RU 5161-05) und 3 V (2 Stück RU 5161-05) gesenkt werden.
Maße: 150 x 80 x 45 mm (L x B x H)

- RU 5161-03** Batteriebox 6 V
- RU 5161-04** Adapter, Bananen-Buchsen auf Cinch-Stecker
- RU 5161-05** Batterieatrappe



Battery box

Battery box 6 V for 4 batteries type C,
with cinch socket and cord switch.
Voltage can be reduced with battery dummy to 4.5 V (1 piece RU 5161-05)
or 3 V (2 pieces RU 5161-05).
Dimensions: 150 x 80 x 45 mm (L x W x H)

- RU 5161-03** Battery box 6 V
- RU 5161-04** Adapter, Banana sockets to cinch plug
- RU 5161-05** Battery dummy



Tischtrafo

Regelbare Spannung von 0 bis 10 V, 2 A
Maße: 200 x 160 x 80 mm (L x B x H)

- RU 5161-20** Tischtrafo, 0-10 V

Desk light transformer

Adjustable voltage from 0 up to 10 V, 2 A
Dimensions: 200 x 160 x 80 mm (L x W x H)

- RU 5161-20** Desk transformer 0-10V



**TROKARE, SAUGKANÜLEN
TROCARS, SUCTION TUBES**



Krause
16 cm / 6¼"
Ø 5,5 mm
RU 5252-15



Coakley
16 cm / 6¼"
Ø 2,25 mm
RU 5253-16



Lichtwitz
19 cm / 7½"
Ø 1,8 mm **RU 5255-19**



Pierce
16 cm / 6¼"
Ø 3 mm **RU 5258-30**
Ø 4 mm **RU 5258-40**
Ø 5 mm **RU 5258-50**

RU 5260-19 ▶



RU 5260-01 ▶ Olive
Ø 7-9 mm

**Saugkopf /
Suction tube**
Ø 10 mm

Ø 6 mm

Yankauer
27 cm / 10½"
RU 5260-27
Saugkanüle
Suction tube

KANÜLEN
CANNULAS



Luer-Lock
Ø 0,8 mm
RU 8375-01
Septumkanüle
Septum needle



Pravaz

0,9 x 38 mm	RU-12131-01
0,8 x 35 mm	RU-12131-02
0,7 x 32 mm	RU-12131-03
0,65 x 30 mm	RU-12131-04
0,6 x 25 mm	RU-12131-05
0,5 x 23 mm	RU-12131-06
0,45 x 18 mm	RU-12131-07

**SPRITZEN, FÜHRUNGSNADELN, REDON
SYRINGES, GUIDE NEEDLES, REDON**



ml / cc	
1	RU-12004-01
2	RU-12004-02
5	RU-12004-05
10	RU-12004-10

Luer-Lock

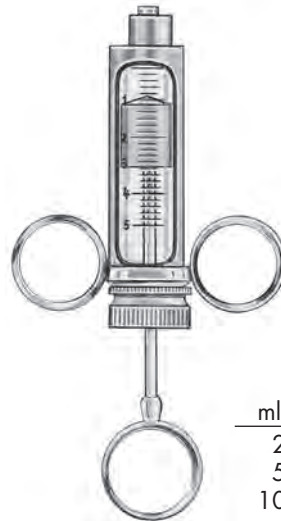

ml / cc	Spritze Syringe	Zylinder Cylinder
2	RU 5285-02	RU 5285-02 /Z
5	RU 5285-05	RU 5285-05 /Z
10	RU 5285-10	RU 5285-10 /Z

Luer-Lock



Charr /Fr.	
8	RU 5291-28
10	RU 5291-30
12	RU 5291-32
14	RU 5291-34



Charr /Fr.	
8	RU 5291-48
10	RU 5291-50
12	RU 5291-52
14	RU 5291-54

KATHETERZANGEN
CATHETER FORCEPS



15 cm / 6"
für Kleinkinder / *for infants*
RU 5295-15

Magill
20 cm / 8"
für Kinder / *for children*
RU 5295-20

25 cm / 10"
für Erwachsene / *for adults*
RU 5295-25

**FLACH- UND HOHLMEISSEL, OSTEOTOME
BONE CHISELS, GOUGES, OSTEOTOMES**



Breite
width
mm

13,5 cm / 5¼"

4	RU 5300-04	RU 5302-04	RU 5304-04
6	RU 5300-06	RU 5302-06	RU 5304-06
8	RU 5300-08	RU 5302-08	RU 5304-08
10	RU 5300-10	RU 5302-10	RU 5304-10
12	RU 5300-12	RU 5302-12	RU 5304-12
14	RU 5300-14	RU 5302-14	RU 5304-14
16	RU 5300-16	RU 5302-16	RU 5304-16

Osteotome
Osteotome

Flachmeißel
Bone chisels

Hohlmeißel
Gouges

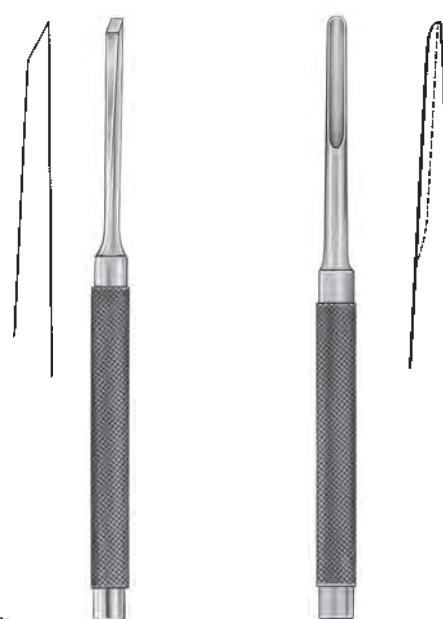

Breite
width
mm

Lucas
16 cm / 6¼"

3	RU 5305-01 /03	RU 5305-02 /03
4	RU 5305-01 /04	RU 5305-02 /04
5	RU 5305-01 /05	RU 5305-02 /05
6	RU 5305-01 /06	RU 5305-02 /06

Flachmeißel
Bone chisels

Hohlmeißel
Gouges

Breite
width
mm

Partsch
13,5 cm / 5¼"

Partsch
13,5 cm / 5¼"

2	RU 5308-02	RU 5314-02
3	RU 5308-03	RU 5314-03
4	RU 5308-04	RU 5314-04
5	RU 5308-05	RU 5314-05
6	RU 5308-06	RU 5314-06
7	RU 5308-07	RU 5314-07
8	RU 5308-08	RU 5314-08

Flachmeißel
Bone chisels

Hohlmeißel
Gouges



Flachmeißel
Bone chisels

Hohlmeißel
Gouges

**STÖSSEL, OSTEOTOME, FLACH- UND HOHLMEISSEL
PESTLES, OSTEOTOMES, BONE CHISELS AND GOUGES**



○ Ø 3 mm
RU 5317-03

○ Ø 5 mm
RU 5317-05

16 cm / 6¼"
Stößel
Pestle



■ 2,5 mm
RU 5318-02

■ 3,5 mm
RU 5318-03

Passow
12 cm / 4¾"



mm
2 **RU 5332-02**
3 **RU 5332-03**
4 **RU 5332-04**
6 **RU 5332-06**
8 **RU 5332-08**
10 **RU 5332-10**
12 **RU 5332-12**
15 **RU 5332-15**

Osteotome
Osteotome

Mini-Lambotte
12,5 cm / 5"



mm
RU 5334-04 4 **RU 5335-04**
RU 5334-06 6 **RU 5335-06**
RU 5334-08 8 **RU 5335-08**
RU 5334-10 10 **RU 5335-10**
RU 5334-12 12 **RU 5335-12**

Osteotome
Osteotome

Mini-Lexer
18 cm / 7"



Hohlmeißel
Osteotome

Mini-Lexer
18 cm / 7"

**SCHARFE LÖFFEL
BONE CURETTES**



Volkman
17 cm / 6¾"

- | | |
|------|-------------------|
| Fig. | |
| 0000 | RU 5350-40 |
| 000 | RU 5350-30 |
| 00 | RU 5350-20 |
| 0 | RU 5350-10 |
| 1 | RU 5350-01 |
| 2 | RU 5350-02 |
| 3 | RU 5350-03 |
| 4 | RU 5350-04 |
| 5 | RU 5350-05 |
| 6 | RU 5350-06 |

2,8 mm
Fig. 0000

3,6 mm
Fig. 000

4,4 mm
Fig. 00

5,2 mm
Fig. 0

6,8 mm
Fig. 1

8,5 mm
Fig. 2

10 mm
Fig. 3

11,5 mm
Fig. 4

14,5 mm
Fig. 5

15,5 mm
Fig. 6

- | | |
|------|-------------------|
| Fig. | Spratt |
| 000 | RU 5353-30 |
| 00 | RU 5353-20 |
| 0 | RU 5353-10 |
| 1 | RU 5353-01 |
| 2 | RU 5353-02 |
| 3 | RU 5353-03 |
| 4 | RU 5353-04 |
| 5 | RU 5353-05 |
| 6 | RU 5353-06 |



Spratt
16 cm / 6¼"

3,0 mm
Fig. 000

4,0 mm
Fig. 00

4,5 mm
Fig. 0

5,0 mm
Fig. 1

6,0 mm
Fig. 2

7,0 mm
Fig. 3

8,5 mm
Fig. 4

9,5 mm
Fig. 5

11,5 mm
Fig. 6

3,0 mm
RU 7993-10

2,7 mm
RU 7993-20

2,4 mm
RU 7993-30

2,0 mm
RU 7993-40

1,7 mm
RU 7993-50



Lempert
21,5 cm / 8½"

**SCHARFE LÖFFEL
BONE CURETTES**



Uffenorde
17 cm / 6¾"
RU 5357-01



Uffenorde
17 cm / 6¾"
RU 5357-02



Martini
13,5 cm / 5"



Jansen
16 cm / 6¼"
RU 5367-00 / 16

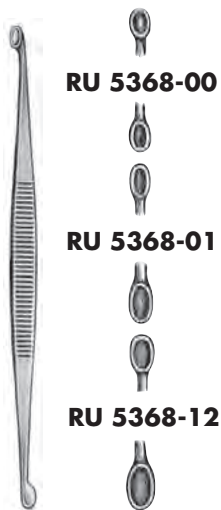

Williger
13,5 cm / 5"



Barth-Preysing
19 cm / 7½"
RU 5369-00 / 19



Jacobson
13 cm / 5"
RU 5369-13

RASPATORIEN
PERIOSTEAL RASPATORIES

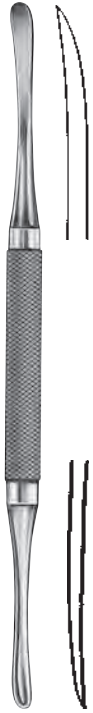

Molt
19 cm / 7½"
RU 5379-19

13 mm



Farabeuf
15 cm / 6"
RU 5380-15

13 mm

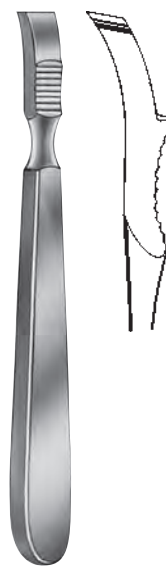

Farabeuf
15 cm / 6"
RU 5381-15

15 mm

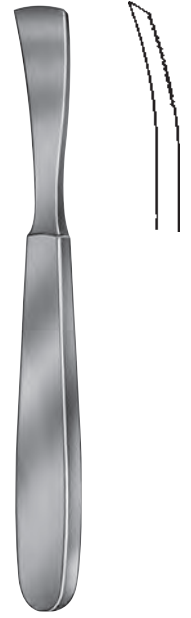

Jansen
16,5 cm / 6½"
RU 5388-16

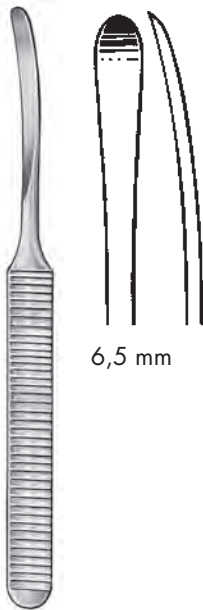

6,5 mm

Williger
16 cm / 6¼"
4,5 mm **RU 5392-05**
8,0 mm **RU 5392-08**
6,5 mm **RU 5392-16**

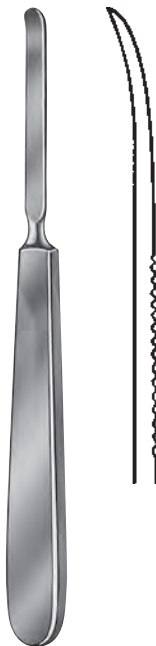

17 cm / 6¾"

6 mm **RU 5394-06** 8 mm **RU 5394-08**

4 mm



Joseph
16 cm / 6¼"
RU 5399-00 / 16

7 mm



Lempert
18,0 cm / 7" **RU 7992-18**
20,5 cm / 8" **RU 7992-20**

RASPATORIEN, ELEVATORIEN
PERIOSTEUM RASPATORIES, ELEVATORS



19 cm / 7½"
RU 5410-01



18,5 cm / 7¼"
RU 5410-02



18,5 cm / 7¼"
RU 5410-03



18,5 cm / 7¼"
RU 5410-04



Langenbeck
20 cm / 8"
RU 5420-20



Williger
16 cm / 6¼"
RU 5426-16



Quervain
20 cm / 8"
RU 5427-20

ELEVATORIEN, HOHLMEISSELZANGEN
ELEVATORS, BONE RONGEUR FORCEPS

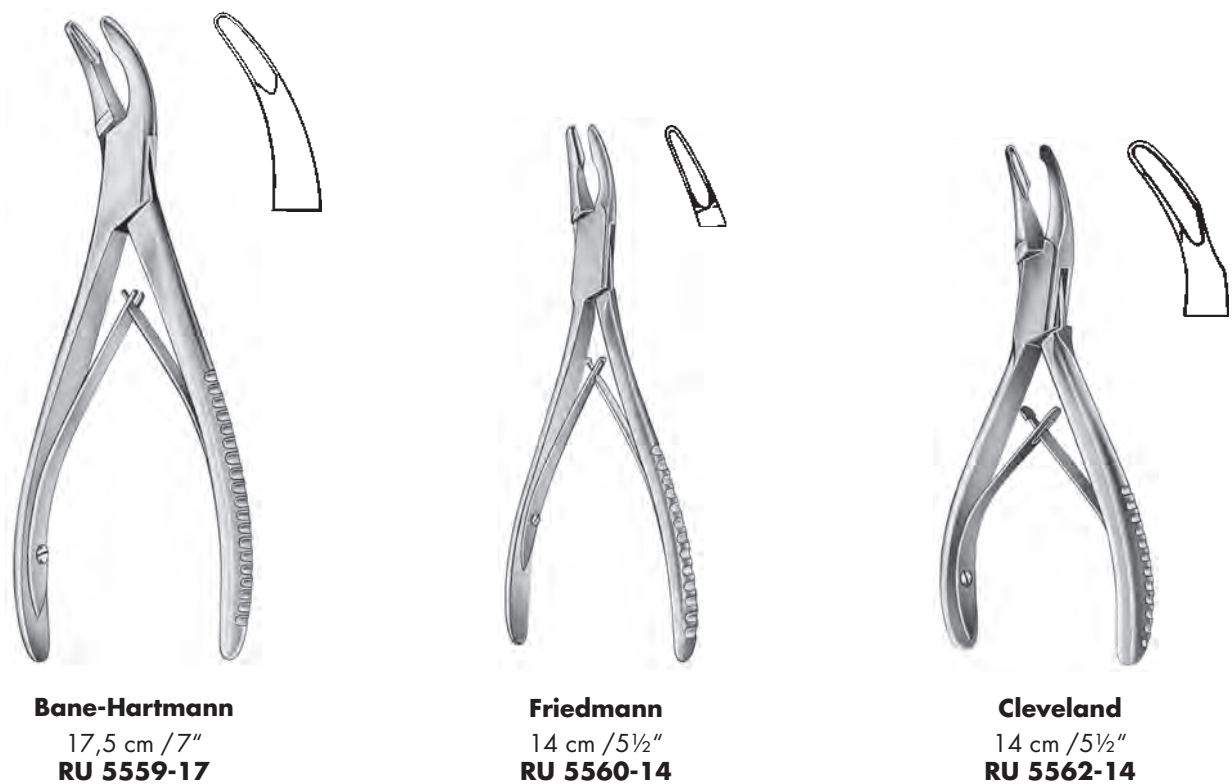

**HOHLMEISSELZANGEN
BONE RONGEUR FORCEPS**



Mead
16,5 cm / 6½"



RU 5566-16

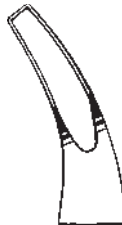

RU 5568-16



Lempert
gerade
straight
gebogen
curved
RU 5570-16
RU 5570-19
RU 5571-16
RU 5571-19



Beyer
18 cm / 7"
RU 5572-18



Jansen
17,5 cm / 7"



RU 5573-17



RU 5574-17



Blumenthal
15,5 cm / 6"



RU 5575-01



RU 5575-02



RU 5575-03

**HOHLMEISSELZANGEN
BONE RONGEUR FORCEPS**

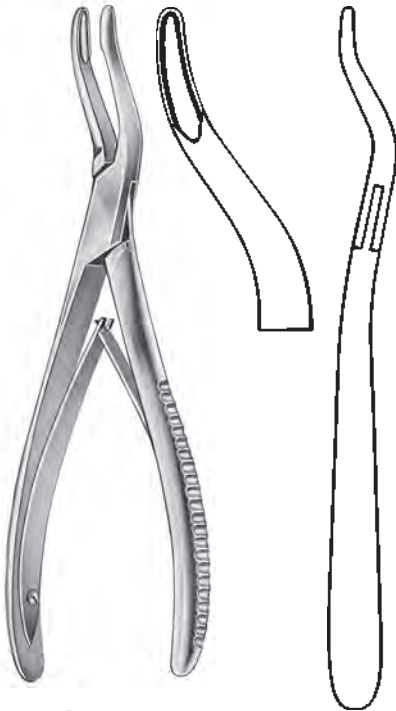

Jansen
18 cm / 7"
RU 5576-19

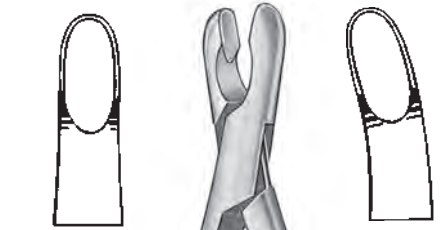

gerade
straight

RU 5580-17

gebogen
curved

RU 5581-17

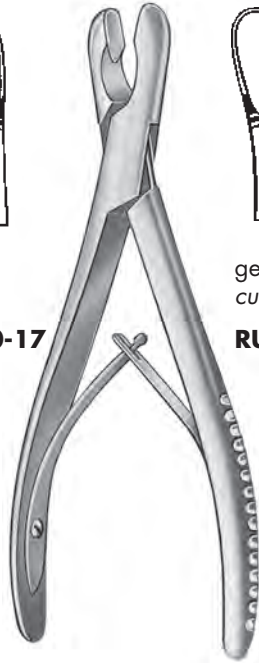

Luer
17 cm / 6¾"

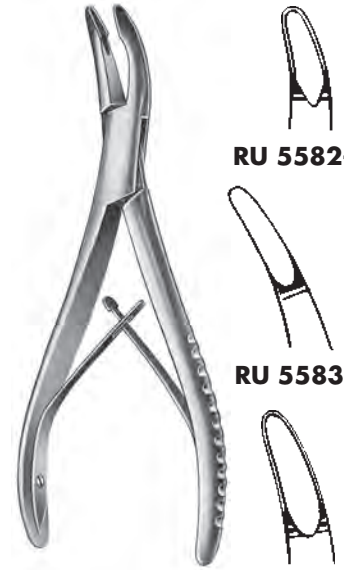

RU 5582-15

RU 5583-15

RU 5584-15

Luer
15 cm / 6"



Böhler
15 cm / 6"



gerade / *straight*

3 mm **RU 5588-15 /1**
4 mm **RU 5588-15**



gebogen / *curved*

RU 5589-15 /1
RU 5589-15



**Zaufal-Jansen
Beyer**
18 cm / 7"



4 mm

Zaufal-Jansen
RU 5590-18

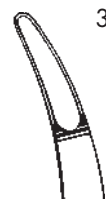

3 mm

Beyer
RU 5592-18

**HOHLMEISSELZANGEN, KNOCHENSPLITTERZANGEN, HÄMMER
BONE RONGEUR FORCEPS, BONE CUTTING FORCEPS, MALLETS**

6 mm



Ruskin
18 cm / 7"
gebogen / curved
RU 5594-18



Böhler
15 cm / 6"

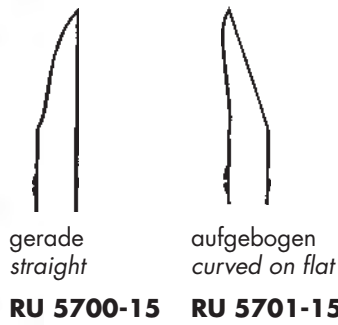

16 cm / 6 1/4"
RU 5759-16

Drahtschneide- und Biegezange
Wire cutting and bending pliers



Ø 30 mm, 215 g
24,5 cm / 9 3/4"
RU 5798-24

Ersatzbackenpaar
Pair of spare jaws
RU 5798-51

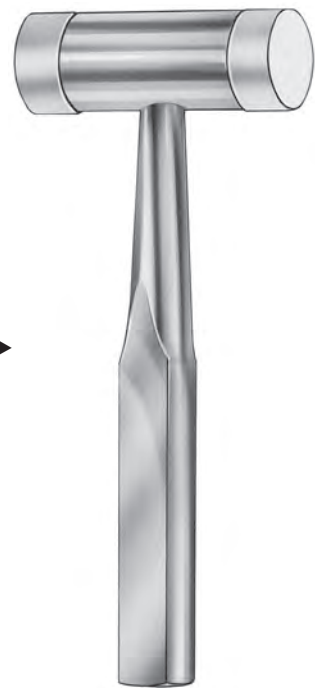

Ø 25 mm, 140 g
18 cm / 7"
RU 5799-18

Ersatzbackenpaar
Pair of spare jaws
RU 5799-51

◀ mit auswechselbaren
Kunststoffbacken
with interchangeable
plastic jaws ▶

**HÄMMER
MALLETS**



Heermann
36 g
19,5 cm / 7½"
RU 5807-19



Cottle
1 Seite flach
1 Seite convex
*1 side flat
1 side convex*
Ø 30 mm, 350 g
19 cm / 7½"
RU 5809-19



Williger
150 g
23 cm / 9½"
bleigefüllt / lead filled
RU 5810-23



Hajek
Ø 27 mm, 140 g
22 cm / 8¾"
RU 5811-23



Ø 22 mm, 165 g
19 cm / 7½"
bleigefüllt / lead filled
RU 5812-19



bleigefüllt
lead filled
RU 5814-16
Messing massiv
solid brass
RU 5815-16

Ø 20 mm
16,5 cm / 6½"

**CHIRURGISCHE NADELN
SURGICAL NEEDLES**

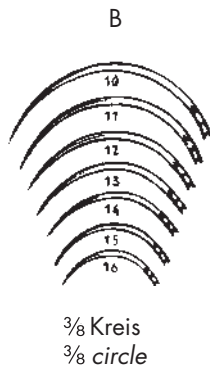





Fig. 

10	RU 5875-10	RU 5875-10 S
11	RU 5875-11	RU 5875-11 S
12	RU 5875-12	RU 5875-12 S
13	RU 5875-13	RU 5875-13 S
14	RU 5875-14	RU 5875-14 S
15	RU 5875-15	RU 5875-15 S
16	RU 5875-16	RU 5875-16 S

Fig. 

10	RU 5879-10	RU 5879-10 S
11	RU 5879-11	RU 5879-11 S
12	RU 5879-12	RU 5879-12 S
13	RU 5879-13	RU 5879-13 S
14	RU 5879-14	RU 5879-14 S
15	RU 5879-15	RU 5879-15 S
16	RU 5879-16	RU 5879-16 S

 Nadeln mit Dreikantschneide
triangular point

 gewöhnliches Ohr
regular eye

 Federöhr
spring eye



Fig. 

0	RU 5898-10	RU 5898-10 S
1	RU 5899-01	RU 5899-01 S
2	RU 5899-02	RU 5899-02 S
3	RU 5899-03	RU 5899-03 S
4	RU 5899-04	RU 5899-04 S
5	RU 5899-05	RU 5899-05 S

Fig. 

0	RU 5900-10	RU 5900-10 S
1	RU 5901-01	RU 5901-01 S
2	RU 5901-02	RU 5901-02 S
3	RU 5901-03	RU 5901-03 S
4	RU 5901-04	RU 5901-04 S
5	RU 5901-05	RU 5901-05 S

**MIKRO-NADELHALTER
MICRO NEEDLE HOLDERS**



gerade /straight gebogen /curved



mit Sperre /with ratchet
gerade /straight gebogen /curved

12 cm /4¾"	RU 5860-12	RU 5861-12	RU 5864-12	RU 5865-12
15 cm /6"	RU 5860-15	RU 5861-15	RU 5864-15	RU 5865-15



Barraquer
12 cm /4¾"
RU 5973-12

**NADELHALTER
NEEDLE HOLDERS**



Brown
13 cm / 5" **RU 5928-13**
18 cm / 7" **RU 5928-18**



Mayo-Hegar
schlankes Modell
delicate pattern
16 cm / 6¼" **RU 6003-16**
18 cm / 7" **RU 6003-18**
20 cm / 8" **RU 6003-20**



Crile-Wood
15 cm / 6"
RU 6012-15



Senning
17 cm / 6¾"
schlank / *slim*
RU 6017-17

NADELHALTER MIT HARTMETALLEINLAGEN
NEEDLE HOLDERS WITH TUNGSTEN CARBIDE INSERTS

Tc



Neivert
13 cm / 5"
zwei Ringe abgewinkelt
two rings angled
RU 6045-13



Mayo-Hegar



Hegar-Baumgartner
14 cm / 5½"
RU 6052-14



Mayo-Hegar
schweres Modell
heavy pattern
20 cm / 8" **RU 6053-20**

NADELHALTER MIT HARTMETALLEINLAGEN
NEEDLE HOLDERS WITH TUNGSTEN CARBIDE INSERTS



De Bakay

18 cm / 7" **RU 6054-18**
20 cm / 8" **RU 6054-20**
23 cm / 9" **RU 6054-23**

Tc

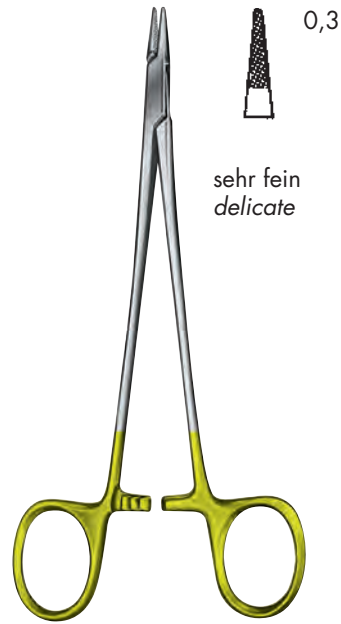

De Bakay

16,5 cm / 6½" **RU 6054-40**
21,0 cm / 8¼" **RU 6054-41**



Baby-Crile-Wood

15 cm / 6"
RU 6055-01

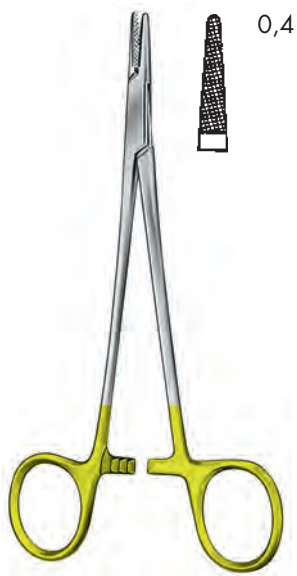

Crile-Wood

15 cm / 6"
RU 6055-15 / 1



Crile-Wood

18 cm / 7" **RU 6055-18**
20 cm / 8" **RU 6055-20**

NADELHALTER MIT HARTMETALLEINLAGEN
NEEDLE HOLDERS WITH TUNGSTEN CARBIDE INSERTS

T_c



Halsey
13 cm /5"

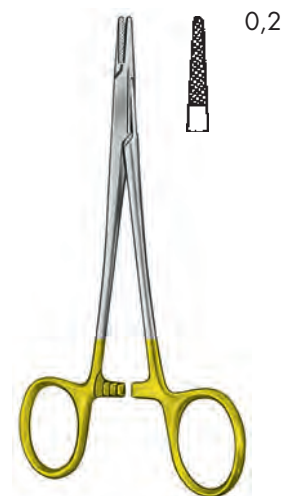

Converse
12,5 cm /5"
RU 6057-12



Ryder



Micro-Ryder



Rudolf
(Swedish pattern)

13 cm /5"	RU 6059-13	RU 6059-63
15 cm /6"	RU 6059-16	RU 6059-65
18 cm /7"	RU 6059-18	RU 6059-68
20 cm /8"	RU 6059-20	RU 6059-70

15 cm /6"	RU 6060-00 /15
17 cm /6¾"	RU 6060-00 /17

NADELHALTER MIT HARTMETALLEINLAGEN
NEEDLE HOLDERS WITH TUNGSTEN CARBIDE INSERTS

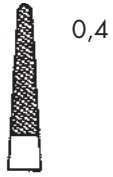

Tc

Sarot
18 cm / 7"
RU 6060-18

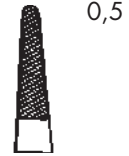

Mathieu
17 cm / 6"
20 cm / 8"
RU 6066-17
RU 6066-20



Langenbeck
20 cm / 8"
24 cm / 9½"
RU 6067-50
RU 6067-54

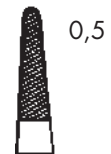

Lichtenberg
20 cm / 8"
RU 6068-20

NADELHALTER MIT HARTMETALLEINLAGEN
NEEDLE HOLDERS WITH TUNGSTEN CARBIDE INSERTS

Tc



Baby-Olsen-Hegar
11,5 cm / 4½"
RU 6079-11



Olsen-Hegar
14 cm / 5½"
RU 6080-14



Olsen-Hegar
17 cm / 6¾"
RU 6080-17

**UNTERBINDUNGSNADELN
LIGATURE NEEDLES**



20 cm / 8"
links, für rechte Hand
left, for right hand



RU 6104-20



scharf
sharp



RU 6106-20



20 cm / 8"
rechts, für linke Hand
right, for left hand

Deschamps-Standard



20 cm / 8"
links, für rechte Hand
left, for right hand



RU 6108-03



scharf
sharp



RU 6108-04



20 cm / 8"
rechts, für linke Hand
right, for left hand

Deschamps

UNTERBINDUNGSNADELN
LIGATURE NEEDLES

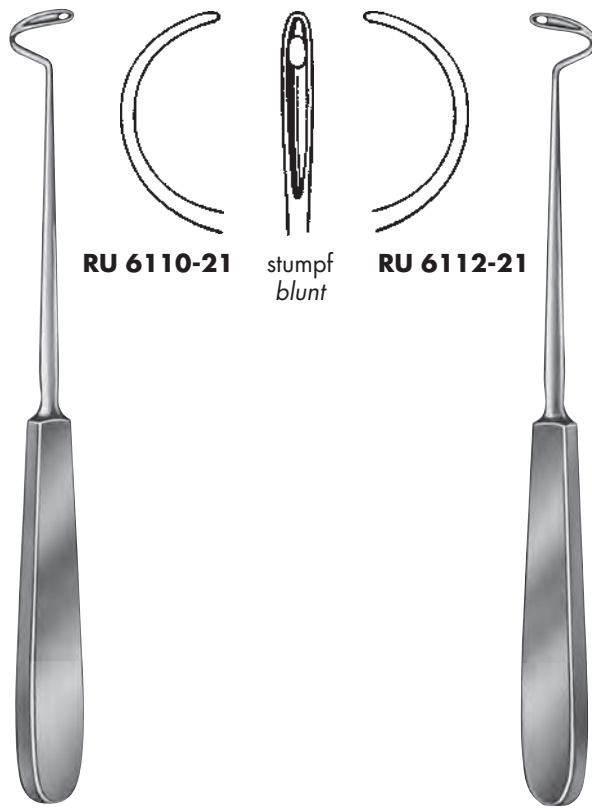

RU 6110-21

stumpf
blunt

RU 6112-21

Deschamps

21 cm / 8¼"
links, für rechte Hand
left, for right hand

21 cm / 8¼"
rechts, für linke Hand
right, for left hand

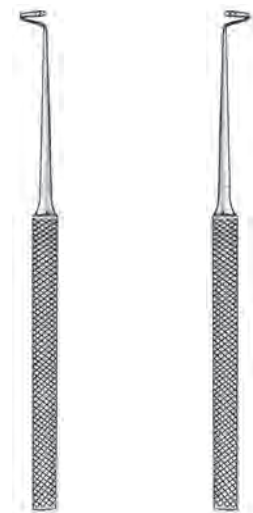

Kronecker

13 cm / 5"
links, für rechte Hand rechts, für linke Hand
left, for right hand right, for left hand
RU 6118-15 **RU 6119-15**

FÜHRUNGSHOHLSONDEN
LIGATURE CONDUCTORS



König
19,5 cm / 7³/₄"
RU 6141-19



König
19,5 cm / 7³/₄"
RU 6142-19



König
20 cm / 8"
RU 6143-20

**ABSAUGROHRE
SUCTION TUBES**

◀ Spitze / tip
3,3 x 6,0 mm



Ø 5 mm Charr. /Fr. 15
17 cm / 6 3/4"
RU 6417-01

mit Saugunterbrecher und Mandrin
with cut-off and stylet

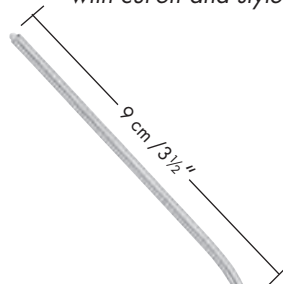

Ø	Charr. /Fr.	
1,5 mm	5	RU 6420-05
2,0 mm	6	RU 6420-06
2,3 mm	7	RU 6420-07
2,5 mm	8	RU 6420-08
3,0 mm	9	RU 6420-09
3,3 mm	10	RU 6420-10
3,5 mm	11	RU 6420-11
4,0 mm	12	RU 6420-12
5,0 mm	15	RU 6420-15

**Frazier
(Fergusson)**

olivenförmig / ball ended

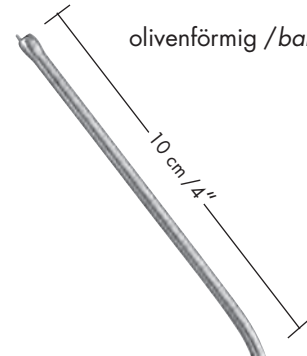

Ø	Charr. /Fr.	
2,0 mm	6	RU 6420-56
2,5 mm	8	RU 6420-58
3,3 mm	10	RU 6420-60
4,0 mm	12	RU 6420-62
5,0 mm	15	RU 6420-65

Frazier



Abstandsmarkierungen
bei 5 – 9 cm
Calibrations marked
at 5 – 9 cm

Ø	Charr. /Fr.	
2,0 mm	6	RU 6420-76
2,5 mm	8	RU 6420-78
3,3 mm	10	RU 6420-80
4,0 mm	12	RU 6420-82
5,0 mm	15	RU 6420-85

Frazier

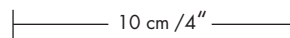

Ø	Charr. /Fr.	
2,0 mm	6	RU 6421-06
2,3 mm	7	RU 6421-07
2,5 mm	8	RU 6421-08
3,0 mm	9	RU 6421-09
3,3 mm	10	RU 6421-10
3,5 mm	11	RU 6421-11
4,0 mm	12	RU 6421-12
5,0 mm	15	RU 6421-15

Fergusson

90°



mit Saugunterbrecher und Mandrin
Griffplatte parallel zur Biegung,
LUER-Bohrung
with cut-off and stylet
thumb piece parallel to curve

Ø	Charr. /Fr.	
1,5 mm	5	RU 6422-15
2,0 mm	6	RU 6422-20
2,5 mm	8	RU 6422-25
3,0 mm	9	RU 6422-30

Plester
19,5 cm / 7 3/4"

MIKRO-ABSAUGROHRE, ABSAUGROHRE
MICRO SUCTION TUBES, SUCTION TUBES



20 cm / 8"
scharf / sharp
RU 6429-30
Saug-Raspatorium
Suction Raspatory

MOTORSYSTEM · BOHRER

MOTOR-SYSTEM · BURRS

Seiten 153 - 160

Pages 153 - 160

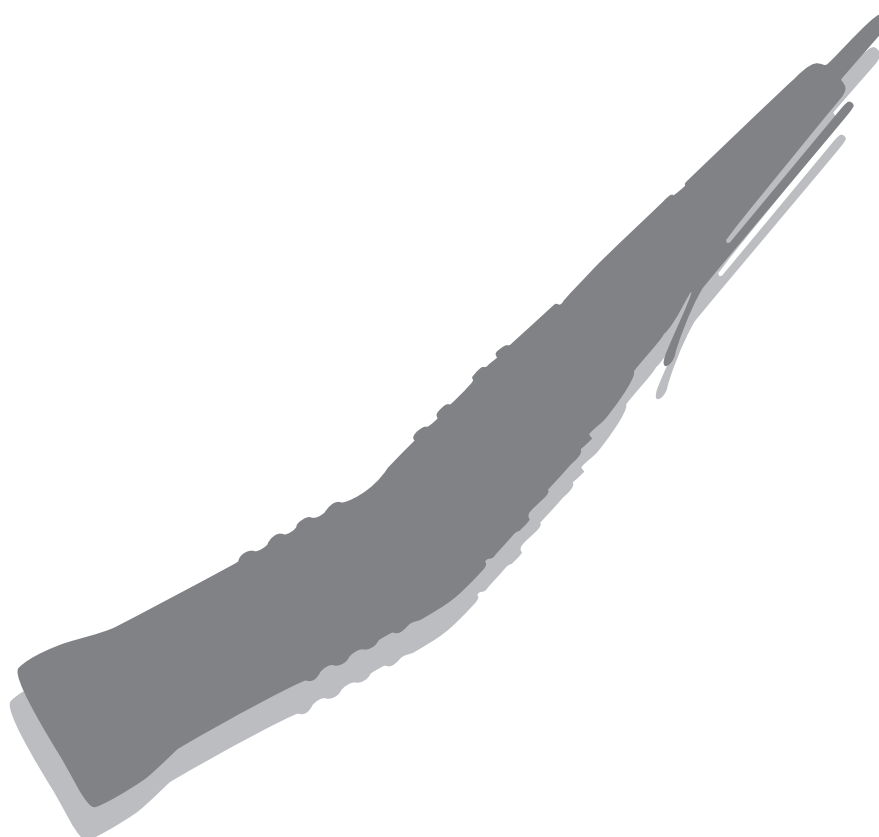

Übersicht

Handstücke, Zubehör
Mikro-Sägen
Bohrer

Overview

Handpieces, accessories
Micro saws
Burs

Seiten / Pages

155
156
157-159



Bei dieser Katalog-Auflage handelt es sich um einen Nachdruck mit geringfügigen Änderungen; daher entfällt der ursprüngliche Inhalt auf dieser Seite.

This catalogue edition is a reprint with minor amendments. This is why the initial content of this page has been removed.

HANDSTÜCKE, ZUBEHÖR
HANDPIECES, ACCESSORIES



Mikro-Geradeaus-Handstück 1:1 Angular micro hand piece 1:1		Länge <i>length</i>	Spitze <i>Tip</i>	Artikel-Nr. <i>Order-Nr.</i>
für Bohrer und Fräser 90-125 mm Schaftdurchmesser 2,35 mm externer Kühlrohraufsatz <i>for burrs and drills 70-90 mm</i> Shank diam. 2,35 mm external irrigation tube	kurz/ <i>short</i>	104 mm	22 mm	RU 7790-020
	mittel/ <i>medium</i>	127 mm	45 mm	RU 7790-021
	lang/ <i>long</i>	157 mm	75 mm	RU 7790-022



Mikro-Winkel-Handstück 1:1 Angular micro hand piece 1:1		Länge <i>length</i>	Spitze <i>Tip</i>	Artikel-Nr. <i>Order-Nr.</i>
für Bohrer und Fräser 70-90 mm Schaftdurchmesser 2,35 mm externer Kühlrohraufsatz <i>for burrs and drills 70-90 mm</i> Shank diam. 2,35 mm external irrigation tube	kurz/ <i>short</i>	104 mm	22 mm	RU 7790-024
	mittel/ <i>medium</i>	127 mm	45 mm	RU 7790-025
	lang/ <i>long</i>	157 mm	75 mm	RU 7790-026



Winkel-Handstück 32:1 micro hand piece 32:1	Länge <i>length</i>	Spitze <i>Tip</i>	Artikel-Nr. <i>Order-Nr.</i>
Untersetzung, 1250 Upm, externer Kühlrohraufsatz, für Bohrer mit Dentalschaft ¹ Angular hand piece Reduction, 1250 rpm, external irrigation tube, for burrs with dental shanks ¹	100-110 mm	75 mm	RU 7790-030

1) Dentalbohrer sind nicht in unserem Lieferprogramm enthalten.
Dental burrs are not included in our product range.

Spray zur Reinigung und Pflege
der Handstücke

Spray for cleaning and
maintenance of handpieces

500 ml
RU 7790-045

**MIKRO-STICHSÄGE, OSZILLIERENDE MIKRO-SÄGE
MICRO COMPASS SAW, MICRO OSCILLATING SAW**



RU 7790-050

Mikro-Stichsäge

ohne Sägeblätter, mit E-Type-Kupplung, externer Kühlrohraufsatz
Max. Motordrehzahl: 12000 upm

Micro Compass Saw

without saw blades, with E-Type-coupling, external irrigation tube
Max. motor speed: 12000 rpm

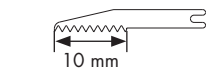

RU 7790-051

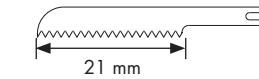

RU 7790-054

Mikro-Sägeblätter

Blattstärke 0,40 mm
Packung à 6 Stück

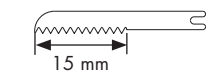

RU 7790-052

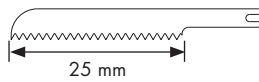

RU 7790-055

Micro saw blades

thickness of blades 0,40 mm
package of 6 pieces

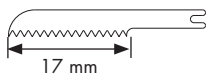

RU 7790-053

RU 7790-051 bis/until RU 7790-055
Packung à 6 Stück/package of 6 pieces



RU 7790-059

**Hartmetall-Raspelaufsatz
TC rasp for micro saw**



RU 7790-060

Oszillierende Mikro-Säge

ohne Sägeblätter, mit E-Type-Kupplung, externer Kühlrohraufsatz
Max. Motordrehzahl: 12000 upm

Micro Oscillating Saw

without saw blades, with E-Type-coupling, external irrigation tube
Max. motor speed: 12000 rpm

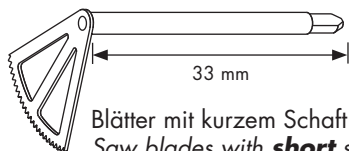

Blätter mit kurzem Schaft
Saw blades with **short** shaft

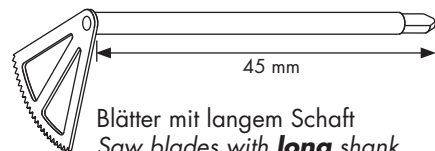

Blätter mit langem Schaft
Saw blades with **long** shank

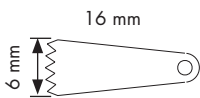

RU 7790-061

RU 7790-064

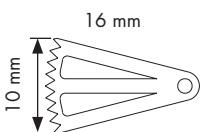

RU 7790-062

RU 7790-065

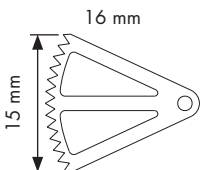

RU 7790-063



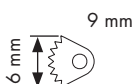















RU 7790-066



RU 7790-068



















RU 7790-067

BOHRER 70 MM, SCHAFT 2,35 MM
BURRS 70 MM, SHAFT 2.35 MM

															
Schaft/shaft Ø mm	0,60	0,70	0,80	1,00	1,40	1,80	2,30	2,70	3,10	3,50	4,00	4,50	5,00	6,00	7,00
ISO-Nr.	006	007	008	010	014	018	023	027	031	035	040	045	050	060	070
Größe/Size	000	00	0	2	4	6	8	10	12	14	16	18	20	22	24
 70 mm RU 7791 Bohrer/Edelstahl Burrs, stainless steel	-006	-007	-008	-010	-014	-018	-023	-027		-035	-040	-045	-050	-060	-070
 70 mm RU 7791 Tc Bohrer/Burrs Hartmetall/carbide	-106	-	-108	-110	-114	-118	-123	-127	3,00 -131	-135	-140	-145	-150	-160	-170
 70 mm RU 7791 Tc Bohrer/Burrs Hartmetall/carbide grob/coarse										-235	-240	-245	-250	-260	-270
 70 mm RU 7791 Bohrer/Burrs Diamant/diamond	-306	-307	-308	-310	1,50 -315	-318	-323	-327	3,00 -330	-335	-340	-345	-350	-360	-370

RU 7791-099 Satz Bohrer/Set of burrs RU 7791-006 - RU 7791-070
RU 7791-199 Satz Bohrer/Set of burrs RU 7791-106 - RU 7791-170
RU 7791-399 Satz Bohrer/Set of burrs RU 7791-306 - RU 7791-370

BOHRER 70 MM UND 95 MM, SCHAFT 2,35 MM
BURRS 70 MM AND 95 MM, SHAFT 2.35 MM

															
Schaft/shaft Ømm	0,60	0,70	0,80	1,00	1,40	1,80	2,30	2,70	3,10	3,50	4,00	4,50	5,00	6,00	7,00
ISO-Nr.	006	007	008	010	014	018	023	027	031	035	040	045	050	060	070
Größe/Size	000	00	0	2	4	6	8	10	12	14	16	18	20	22	24
 70 mm RU 7791 Finierer, Edelstahl <i>Finishing burrs, stainless steel</i>	-406	-407	-408	-410	-414	-418		-427	-431	-435	-440	-445	-450	-460	-470
 95 mm RU 7792 Bohrer, Edelstahl <i>Burrs, stainless steel</i>				-010	-014	-018	-023	-027	-031	-035	-040	-045	-050	-060	-070
 95 mm RU 7792 Bohrer, Burrs Hartmetall/carbide Tc	-107		-110		1,50 -115	-118		2,50 -125	3,00 -130	-135	-140	-145	-150	-160	-170
 95 mm RU 7792 Bohrer/Burrs Diamant/diamond	-206	-207	-208	-210	1,50 -215	-218	-223	-227	3,00 -230	-235	-240	-245	-250	-260	-270

RU 7791-499 Satz Bohrer/Set of burrs RU 7791-406 - RU 7791-470

FRÄSER 70 MM, SCHAFT 2,35 MM
CUTTERS 70 MM, SHAFT 2.35 MM



70 mm
Kegelfräser, mit Querhieb
Cone cutters, cross-cut

Ø 4,0 mm
RU 7793-040

Ø 5,0 mm
RU 7793-050

Ø 6,0 mm
RU 7793-060

Ø 8,0 mm
RU 7793-080



70 mm
Kegelfräser, gerade Verzahnung
Cone cutters, plain cut

Ø 5,0 mm
RU 7793-250

Ø 6,0 mm
RU 7793-260

8,0 mm Ø
RU 7793-280



70 mm
Walzenfräser mit Querhieb
Barrel Burs, cross-cut

Ø 4,0 mm
RU 7793-440

Ø 5,0 mm
RU 7793-450

Ø 6,0 mm
RU 7793-460

Ø 8,0 mm
RU 7793-480



90x50x8,5 mm
RU 7793-800
Bohrerstände für 24 Bohrer
Burr block for 24 burrs

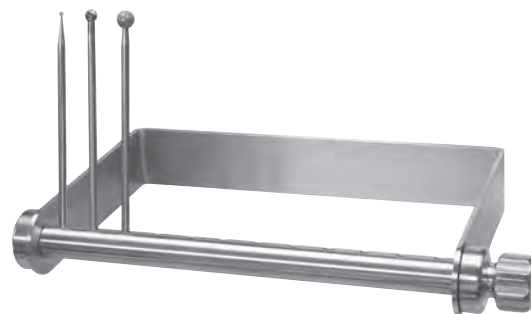

RU 7793-810
Bohrerstände für 12 Bohrer 70 mm
Burr block for 12 burrs 70 mm

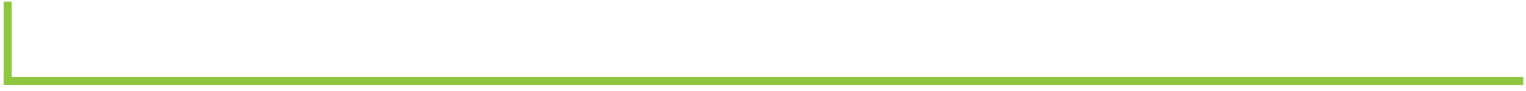

OTOLOGIE OHR-MIKROCHIRURGIE

OTOLOGY EAR MICRO SURGERY

Seiten 161 - 242

Pages 161 - 242



Übersicht

Scheren, Pinzetten
Wundsperrer, Spreizer
Ohrsonden, Watteträger
Nystagmus-Brillen, Zubehör
Meißel, Osteotome, Stößel
Löffel, Raspatorien
Zangen, Hämmer, Stanzen
Ohrspekulas, Sets, Zubehör
Stimmgabeln, Sets, Lärmtrommeln
Saugrohre, -adapter, -instrumente
Polypenschnürer, -schlingen
Ohr-, Löffel-, Drahtbiegezaugen
Micro-Instrumente, OP-Gestell, Schutzhülse
Tubeninstrumentarium, (Paukenröhrchen)
Mikrozangen, -scheren, -stanzen
Mikrochirurg, Besteck, Skalpelle, Messer
Nadeln, Häkchen
Diverses Instrumentarium
Küretten, Löffel, Schlingen

General View

Scissors, forceps
Retractors, spreader
Ear probes, applicators
Nystagmus spectacles, accessories
Chisels, gouges, osteotomes, pestles
Bone curettes, raspatories
Forceps, mallets, punches
Ear speculas, sets, accessories
Tuning forks, sets, noise apparatus
Suction tubes, adapters, -instruments
Polypus snares, -loops
Ear, cup-shaped and wire bending forceps
Micro instruments, OP-rack, protect sleeve
Tube instrumentation
Micro forceps, -scissors, -nippers
Micro surgery sets, scalpels, knives
Needles, hooks
Various instruments
Curettes, spoons, loops

Seiten / Pages

162-166
167-169
170-171
172
173-174
175-178
179-184
185-190
191-194
195-198
199
200-207, 219
208
209-216
217-221, 205, 207
222-225, 238-239
226-228, 238, 239
229-235, 240-242
236-237

PRÄPARIERSCHEREN, FEINE SCHEREN
DISSECTING SCISSORS, FINE SCISSORS



Metzenbaum
14,5 cm/5½"
gerade/straight
RU 1304-14

Tc



Metzenbaum-Fino
14,5 cm/5½"
gerade/straight
RU 1306-14

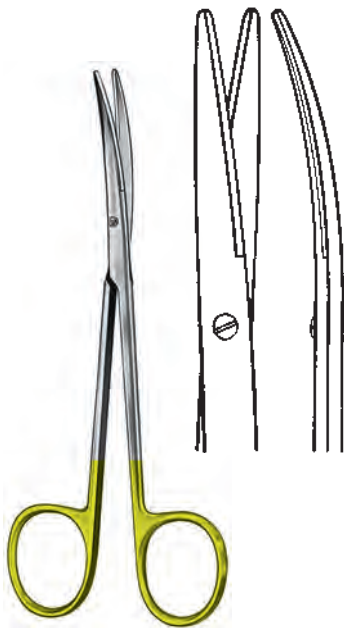

Metzenbaum
14,5 cm/5½"
gebogen/curved
RU 1314-14

Tc



Metzenbaum-Fino
14,5 cm/5½"
gebogen/curved
RU 1316-14



Joseph
gerade/straight
RU 1670-14



Joseph
14 cm/5¼"
gebogen/curved
RU 1671-14

MIKRO-SCHEREN, PRÄPARIERSCHEREN
MICRO-SCISSORS, DISSECTING SCISSORS



Gorney
12,5 cm/5"
gerade, gezahnt
straight, serrated
RU 1688-12 MC



Gorney
12,5 cm/5"
gebogen, gezahnt
curved, serrated
RU 1689-12 MC



15 cm/6"
RU 1792-15

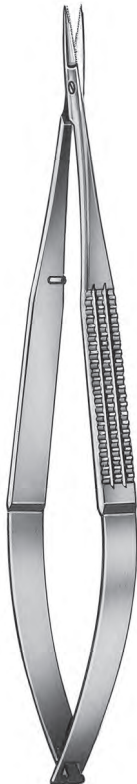

Millesi
16 cm/6¼"
gerade, gezahnt
straight, serrated
RU 2376-16

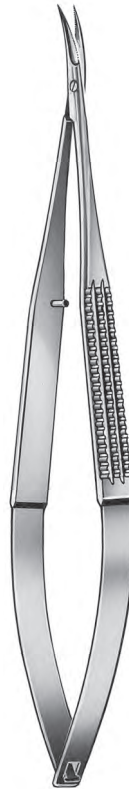

Millesi
16 cm/6¼"
gebogen, gezahnt
curved, serrated
RU 2377-16

FEINE SCHEREN
FINE SCISSORS



Fino
gerade/straight

9,5 cm/3¾" **RU 2422-09**
10,5 cm/4¼" **RU 2422-10**
11,5 cm/4½" **RU 2422-11**

Fino
gebogen/curved

RU 2423-09
RU 2423-10
RU 2423-11



11,5 cm/4½"
gerade/straight
RU 2462-11

Tc



11,5 cm/4½"
gebogen/curved
RU 2463-11



Schuknecht
10 cm/4"
gezahnt/saw edge
RU 2615-10

PINZETTEN
DRESSING AND TISSUE FORCEPS



12 cm/5"
15 cm/6"

Semken
RU 4040-12
RU 4040-15



Semken
RU 4140-12
RU 4140-15



Lazar
15,5 cm/6"



0,5 mm

RU 4075-05



0,8 mm

RU 4075-08



Derlacki
12 cm/4¾"
RU 4143-12



No. 5
11,5 cm/4½"
RU 4240-05

OHRPINZETTEN
EAR DRESSING AND TISSUE FORCEPS

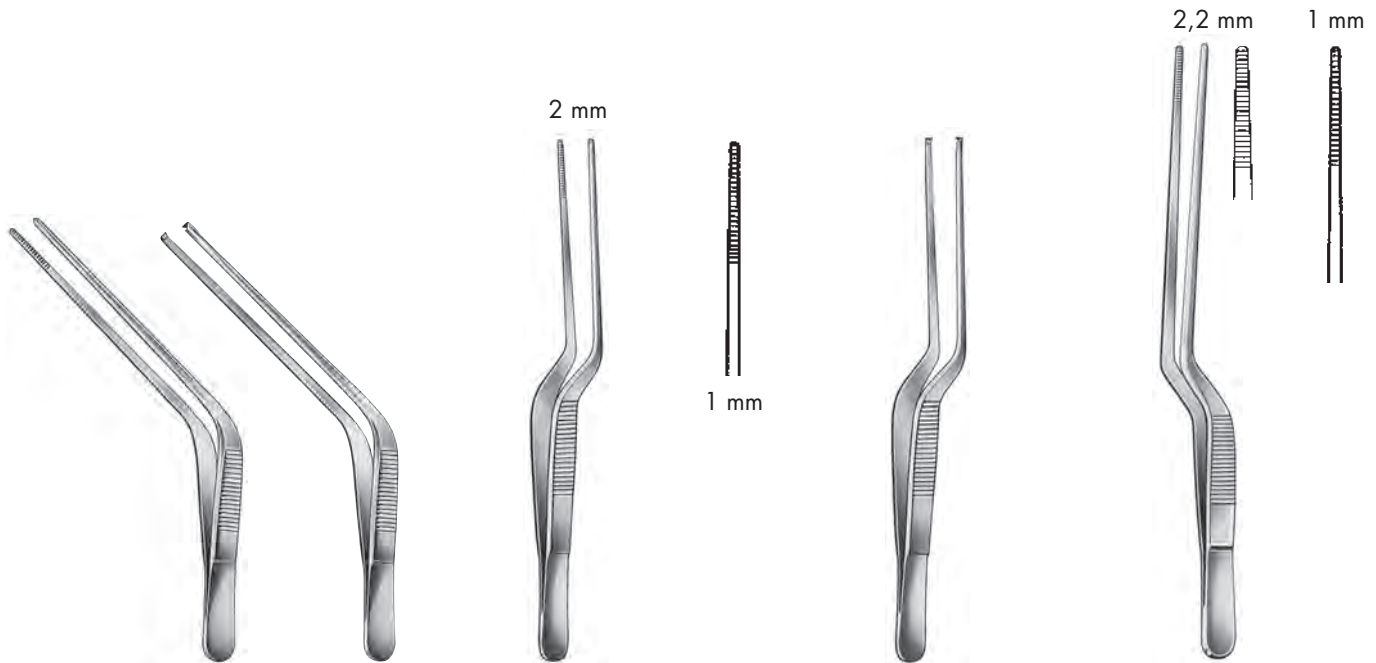

		Troeltsch (Wilde)	Troeltsch	Lucae		Lucae	Jansen (Gruenwald)	
11 cm	4½"	RU 7860-11						
12 cm	4¾"	RU 7860-12	RU 7861-12					
14 cm	5½"			RU 7862-14	RU 7862-14/1	RU 7863-14		
15 cm	6"	RU 7860-15						
16 cm	6¼"						RU 7864-16	RU 7864-16/1
18 cm	7"	RU 7860-18					RU 7864-18	RU 7864-18/1
20 cm	8"						RU 7864-20	RU 7864-20/1



Jansen

16 cm/6¼"
RU 7865-16
18 cm/7"
RU 7865-20

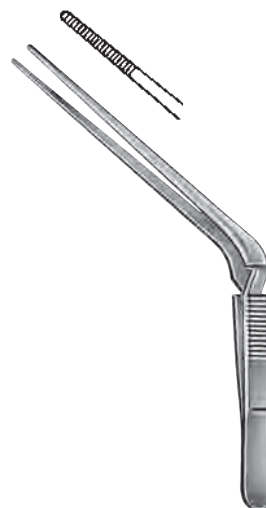

Troeltsch
12 cm/4¾"
selbstschließend
cross action
RU 7866-12

**WUNDSPERRER
RETRACTORS**

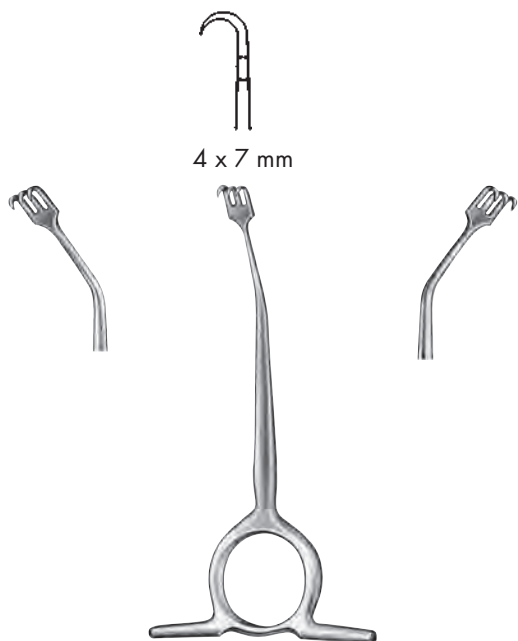

4 x 7 mm

Williger

12 cm/4¾"

RU 4472-24 RU 4472-25 RU 4472-26



Allport

9,5 cm/3¾"

RU 4645-09



Jansen

10,5 cm/4¼"

scharf/sharp stumpf/blunt

RU 4680-10 RU 4681-10

**WUNDSPERRER
RETRACTORS**



Plester
11 cm/4½"
RU 4690-01



Plester-Helms
11 cm/4½"
RU 4689-01

volles Blatt mit
atraumatischer Zahnung
*Blade with
atraumatic teeth*



Plester
11 cm/4½"
RU 4690-02



Plester-Helms
11 cm/4½"
RU 4689-02

volles Blatt mit
atraumatischer Zahnung
*Blade with
atraumatic teeth*



Plester
13 cm/5"
scharf/sharp stumpf/blunt
RU 4691-01 RU 4691-02

**WUNDSPERRER
RETRACTORS**



Weitlaner

scharf/sharp stumpf/blunt



Weitlaner-Wullstein

scharf/sharp stumpf/blunt



Bellucci

scharf/sharp

13,0 cm/5"	RU 4700-13	RU 4701-13	RU 4710-13	RU 4711-13	RU 4713-13
16,5 cm/6½"	RU 4700-16	RU 4701-16	RU 4710-16	RU 4711-16	



Fisch

17 cm/6¾"
RU 4736-17

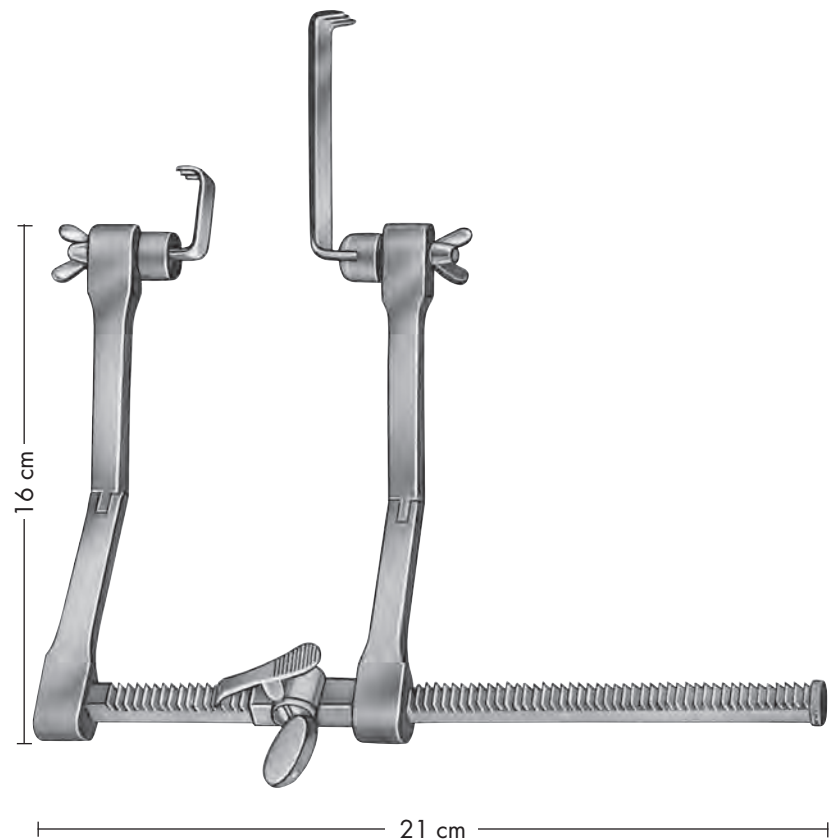

RU 4784-00

Glomus-Spreizer
Glomus spreader

OHRSONDEN
EAR PROBES



Stacke
10,5 cm/4¼"
Ø 1,0 mm
RU 4916-10

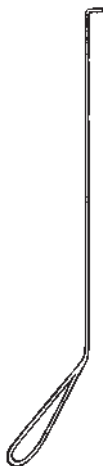

Stacke-Frenzel
9 cm/3½"
RU 4916-10/01



Kley
26 cm/10¼"
RU 4919-26



28 cm/10¾"
RU 4919-26/01

Schutzhülse zu RU 4919-26
Protective shield for RU 4919-26



Seiffert
18 cm/7"
Ø 0,5 mm
RU 4924-18

WATTETRÄGER
COTTON APPLICATORS



Buck
12 cm/4¾"
Ø 0,9 mm
RU 4927-12



Piccolo
11 cm/4½"
Ø 0,7 mm
rund/round
RU 4928-01/11



Piccolo
11 cm/4½"
Ø 0,7 mm
dreikant/triangular
RU 4928-02/11



	Universal Ø 1,2 mm	Ø 1,5 mm	Ø 1,7 mm
12,5 cm/5"	RU 4930-12		RU 4932-12
16,0 cm/6¼"	RU 4930-16		RU 4932-16
18,0 cm/7"		RU 4931-18	RU 4932-18



Jobson-Horne
18 cm/7"
RU 4933-02/18



Farell
(Farell-Lathbury)

rund
round

dreikant
triangular

14 cm/5½"	Ø 0,9 mm	RU 4935-14	RU 4936-14
16 cm/6¼"	Ø 1,1 mm	RU 4935-16	RU 4936-16

NYSTAGMUS-BRILLEN NYSTAGMUS SPECTACLES

Nystagmus-Brillen nach Prof. Frenzel Nystagmus Spectacles by Prof. Frenzel

- | | | |
|-------------------|--|---|
| RU 5140-11 | - feste Gläser
- festes Anschlußkabel
- Clip-Kopfband | - <i>fixed lenses</i>
- <i>fixed connection wire</i>
- <i>Clip head strap</i> |
| RU 5140-00 | - klappbare Gläser
- festes Anschlußkabel
- Kopfband | - <i>hinged lenses</i>
- <i>fixed connection wire</i>
- <i>head strap</i> |
| RU 5140-22 | - feste Gläser
- festes regelbarer Batteriegriff, oben | - <i>fixed lenses</i>
- <i>adjustable battery holder on top</i> |
| RU 5140-23 | - seitlicher Bajonetverschluss
- feste Gläser
- regelbarer Batteriegriff | - <i>lateral bajonet interlocking</i>
- <i>fixed lenses</i>
- <i>adjustable battery hold universal applicable</i> |



RU 5140-11



RU 5140-22

Zubehör/ accessories

- RU 5140-40** Bajonetkabel, Verbindung Brille -Batteriegriff, Bajonet
Bajonet cable, connection spectacle battery holder, bajonet
- RU 5140-41** Anschlußkabel, Brille zu Spannungsquellen
Connection wire, spectacle for power sources
- RU 5140-42** Clipkopfband, schwarz
Clip Head strap, black

RU 5140-70 Batteriegehäuse

gewährleistet die Stromversorgung der Nystagmus-Brille über 3 Batterien Babyzellen (C LR14/AM-2) 1,5 V und ermöglicht so (Stromnetz-) unabhängiges Arbeiten.

Batterien nicht im Lieferumfang

Battery Housing

In order to allow a usage independent of the power supply, alternatively the Nystagmus Spectacle can be supplied with power through the battery housing. It can be operated with three 1.5 Volt batteries, size C LR14/AM-2 (baby cells).

Batteries are not included



RU 5140-50 Ersatzlampe

für alle Nystagmus-Brillen,
4 V, 0,23 Ampere, 1 Watt

Replacement lamp

*for all Nystagmus Spectacles,
4 Volt, 0.23 Ampere, 1 Watt*

**FLACH- UND HOHLMEISSEL, OSTEOTOME
CHISELS, GOUGES AND OSTEOTOMES**

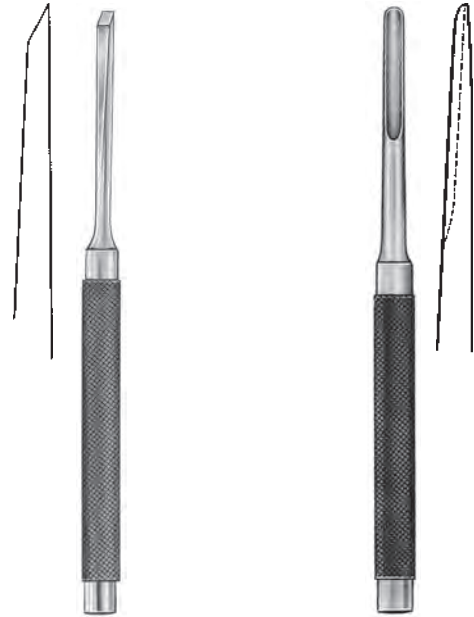
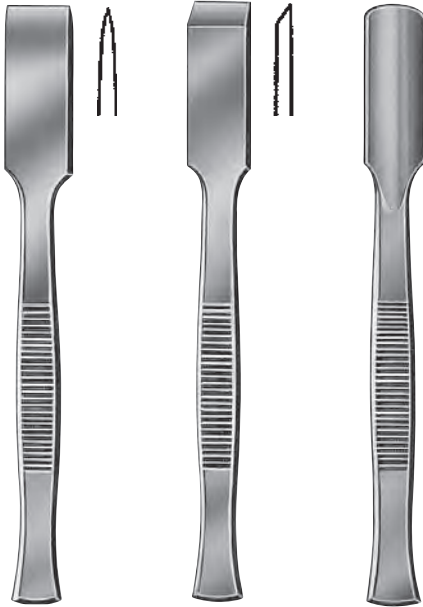

Breite/
width

		13,5 cm/5¼"	
4 mm	RU 5300-04	RU 5302-04	RU 5304-04
6 mm	RU 5300-06	RU 5302-06	RU 5304-06
8 mm	RU 5300-08	RU 5302-08	RU 5304-08
10 mm	RU 5300-10	RU 5302-10	RU 5304-10
12 mm	RU 5300-12	RU 5302-12	RU 5304-12
	Osteotome Osteotomes	Flachmeißel Chisels	Hohlmeißel Gouges

Lucas
16 cm/6¼"

3 mm	RU 5305-01/03	RU 5305-02/03
4 mm	RU 5305-01/04	RU 5305-02/04
5 mm	RU 5305-01/05	RU 5305-02/05
6 mm	RU 5305-01/06	RU 5305-02/06
	Flachmeißel Chisels	Hohlmeißel Gouges

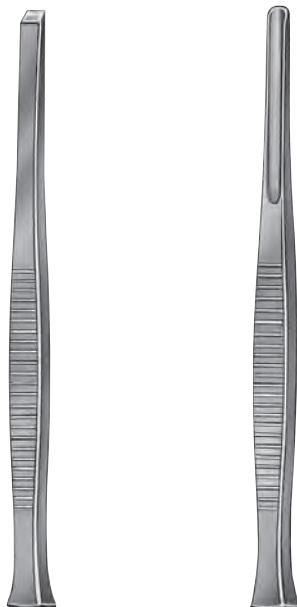

Partsch		Partsch	
13,5 cm/5¼"	mm	13,5 cm/5¼"	
RU 5308-02	2	RU 5314-02	
RU 5308-03	3	RU 5314-03	
RU 5308-05	5	RU 5314-05	
RU 5308-07	7	RU 5314-07	
RU 5308-08	8	RU 5314-08	
Flachmeißel Chisels		Hohlmeißel Gouges	



Thies
16 cm/6¼"
Flachmeißel
Chisels



Thies
16 cm/6¼"
Hohlmeißel
Gouges

**STÖSSEL UND MEISSEL
PESTLES AND CHISELS**



16 cm/6¼"

○ Ø 3 mm
RU 5317-03

○ Ø 5 mm
RU 5317-05

○ Ø 7 mm
RU 5317-07

○ Ø 9 mm
RU 5317-09



Passow
12 cm/4¾"

■ 2,5 mm
RU 5318-02

■ 3,5 mm
RU 5318-03



Osteotome
Osteotomes

RU 5334-04 4 mm
RU 5334-06 6 mm
RU 5334-08 8 mm
RU 5334-10 10 mm
RU 5334-12 12 mm

Mini-Lexer

18 cm/7"

Hohlmeißel
Gouges

RU 5335-04
RU 5335-06
RU 5335-08
RU 5335-10
RU 5335-12



**SCHARFE LÖFFEL
BONE CURETTES**



Volkman
17 cm/6¾"

- Fig.
0000 **RU 5350-40**
000 **RU 5350-30**
00 **RU 5350-20**
0 **RU 5350-10**
1 **RU 5350-01**
2 **RU 5350-02**
3 **RU 5350-03**
4 **RU 5350-04**
5 **RU 5350-05**
6 **RU 5350-06**

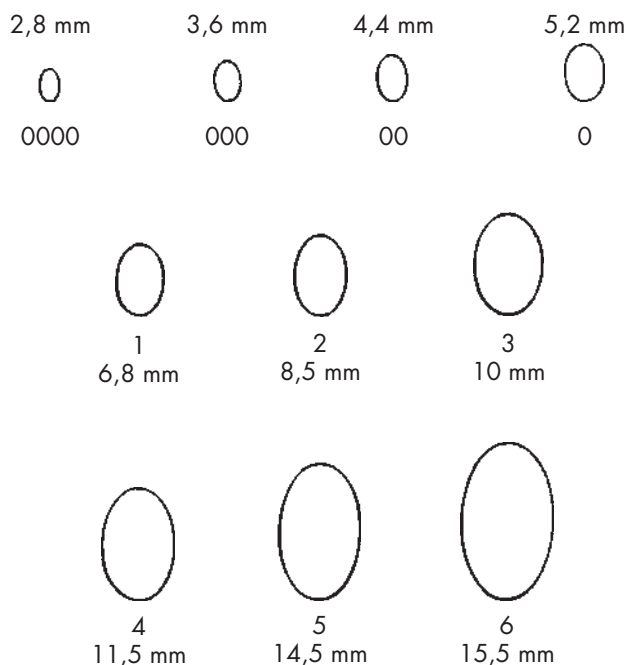

Lempert
17,5 cm/7"

- RU 7993-10**
 RU 7993-20
 RU 7993-30
 RU 7993-40
 RU 7993-50



Williger
17,5 cm/7"

- RU 5356-20**
00
 RU 5356-10
0
 RU 5356-01
1
 RU 5356-02
2

**SCHARFE LÖFFEL
BONE CURETTES**

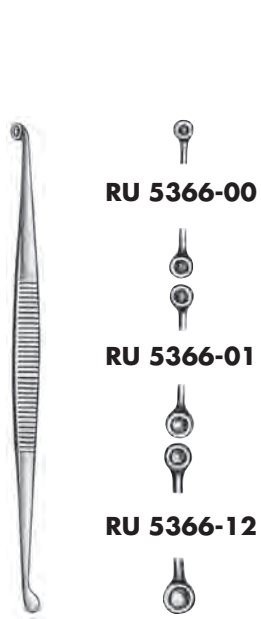

Martini
13,5cm/5"



Jansen
16 cm/6¼"
RU 5367-00/16

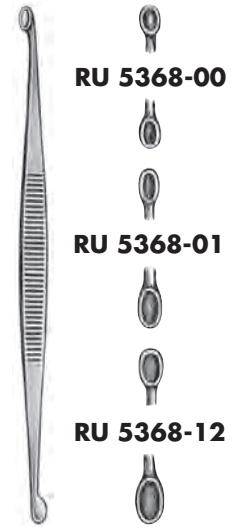

Williger
13,5 cm/5"



Barth-Preysing
19 cm/7½"
RU 5369-00/19



Jacobson
13 cm/5"
RU 5369-13



Miller
18 cm/7"
RU 5370-18

RASPATORIEN
PERIOSTEAL RASPATORIES



Farabeuf
15 cm/6"
RU 5380-15



Farabeuf
15 cm/6"
RU 5381-15

15 mm



Jansen
16,5 cm/6½"
RU 5388-16

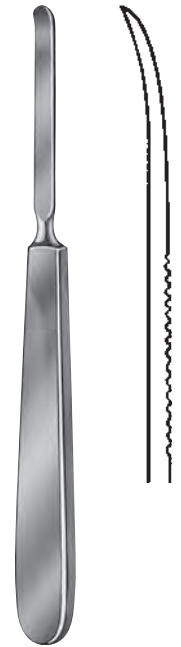

17 cm/6¾"
6 mm 8 mm
RU 5394-06 RU 5394-08



19 cm/7½"
RU 5410-01



18,5 cm/7¼"
RU 5410-02



18,5 cm/7¼"
RU 5410-03



18,5 cm/7¼"
RU 5410-04

RASPATORIEN, ELEVATORIEN, PERIOSTMESSER
PERIOSTEAL RASPATORIES, ELEVATORIES, PERIOSTEAL KNIFE



Eicken
Ø 6 mm
19,5 cm/7¾"
RU 5413-06



Jansen
Ø 9 mm
19,5 cm/7¾"
RU 5414-09



Jansen
Ø 14 mm
19,5 cm/7¾"
RU 5414-14

Raspatorien/Raspatories



Quervain
20 cm/8"
RU 5427-20



König
Ø 4,5 mm
15 cm/6"
RU 5431-01



Sebileau
17 cm/6¾"
RU 5436-17



Muck
13,5 cm/5⅛"
RU 7955-13
Periostmesser
Periosteal Knife

Elevatoren/Elevatories

**HOHLMEISSELZANGEN
BONE RONGEUR FORCEPS**



Friedmann
14 cm/5½"
RU 5560-14

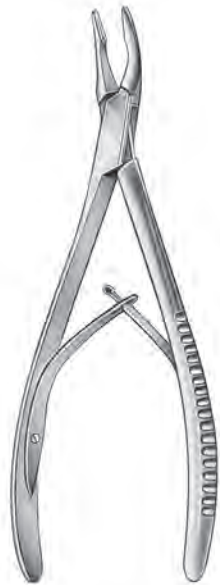

Friedmann-Delikat
15 cm/6"



RU 5561-15

90°

RU 5561-90



Lempert

gerade
straight

gebogen
curved

RU 5570-16 16 cm/6¼" **RU 5571-16**
RU 5570-19 19 cm/7½" **RU 5571-19**



Beyer
18 cm/7"
RU 5572-18



Jansen
18 cm/7"
RU 5576-19



Heanley
19 cm/7½"
RU 5578-19

**HOHLMEISSELZANGEN
BONE RONGEUR FORCEPS**

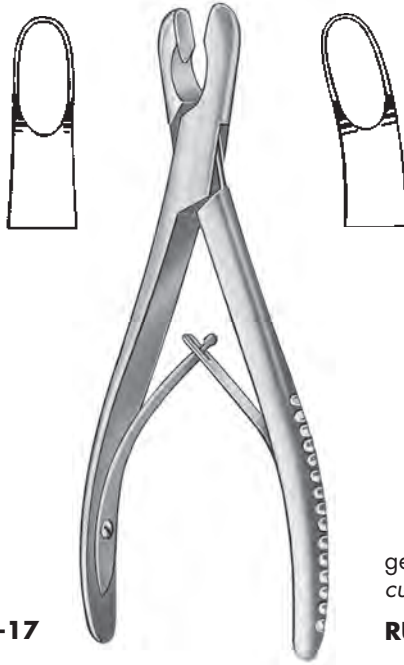

gerade
straight

RU 5580-17

gebogen
curved

RU 5581-17

Luer
17 cm/6³/₄"



Böhler
15 cm/6"



gerade/straight

RU 5588-15/1
RU 5588-15

3 mm
4 mm



gebogen/curved

RU 5589-15/1
RU 5589-15



**Beyer
Zaufal-Jansen**

18 cm/7"



Zaufal-Jansen
RU 5590-18

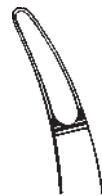

Beyer
RU 5592-18

KNOCHENSPLITTERZANGEN
BONE CUTTING FORCEPS

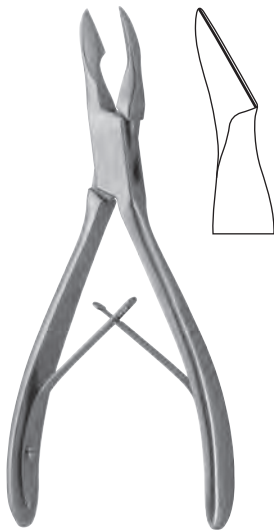

Cleveland

13 cm/5" **RU 5648-13**
15 cm/6" **RU 5648-15**
17 cm/6¾" **RU 5648-17**



Böhler

15 cm/6"



gerade
straight

RU 5700-15



aufgebogen
curved on flat

RU 5701-15

**HÄMMER
MALLETS**



Ersatzbackenpaar
Pair of spare jaws
RU 5798-51

◀ mit auswechselbaren
Kunststoffbacken
with interchangeable
plastic jaws ▶

24,5 cm/9¾"
Ø 30 mm, 215 g
RU 5798-24



Ersatzbackenpaar
Pair of spare jaws
RU 5799-51

18 cm/7"
Ø 25 mm, 140 g
RU 5799-18



Heermann
19,5 cm/7½"
36 g
RU 5807-19



Cottle
19 cm/7½"
Ø 30 mm, 250 g
1 Seite flach, 1 Seite konvex
1 side flat, 1 side convex
RU 5809-19

**HÄMMER
MALLETS**



Hajek
22 cm/8¾"
Ø 27 mm, 140 g
RU 5811-23



19 cm/7½"
Ø 22 mm, 165 g
bleigefüllt, lead filled
RU 5812-19



Fig. 1
19 mm Ø, 80 g
RU 5813-01

Fig. 2
25 mm Ø, 250 g
RU 5813-02

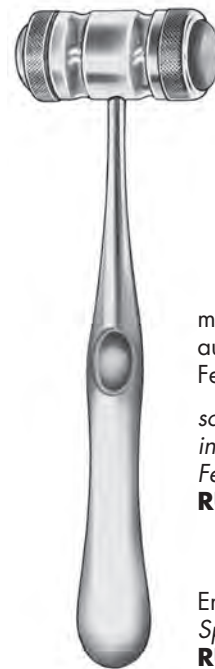

massiv, mit
auswechselbaren
Ferozellbacken
*solid, with
interchangeable
Ferozell jaws*
RU 5816-17

Ersatzbackenpaar
Spare jaws, pair
RU 5816-20

Mead
17 cm/6¾"
Ø 26 mm, 320 g

KNOCHENSTANZEN
EAR PUNCHES

90° nach oben schneidend

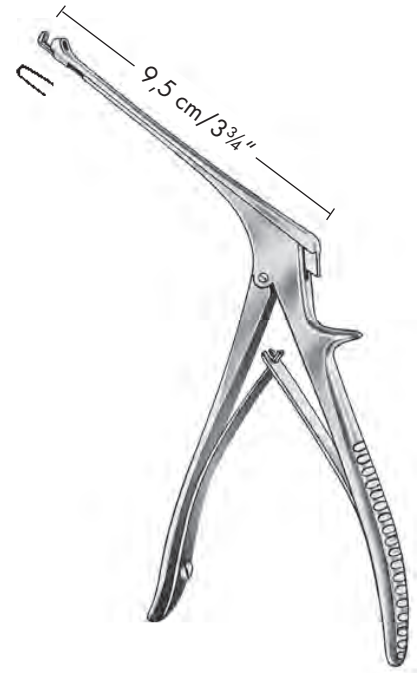

Citelli
Bißbreite
Width of bite
1 mm **RU 7895-10**
2 mm **RU 7895-20**
3 mm **RU 7895-30**

Beyer
Bißbreite
Width of bite
1 mm **RU 7896-15**

90° nach oben schneidend



Kerrison
20 cm / 8"
3,0 mm **RU 8134-03**
4,0 mm **RU 8134-04**
5,0 mm **RU 8134-05**
6,0 mm **RU 8134-06**



Farrior

oval,
20° abgescrängt
oval,
20° slanted

rostfreier Stahl
stainless steel

		I Ø	A Ø	
	Fig. 1	3,0 x 4,0 mm	3,8 x 4,8 mm	RU 7801-01 NR
	Fig. 2	4,0 x 5,0 mm	4,8 x 5,8 mm	RU 7801-02 NR
	Fig. 3	4,5 x 5,5 mm	5,3 x 6,3 mm	RU 7801-03 NR
	Fig. 4	5,0 x 6,0 mm	5,8 x 6,8 mm	RU 7801-04 NR
	Fig. 5	5,5 x 6,5 mm	6,3 x 7,3 mm	RU 7801-05 NR
	Fig. 6	6,0 x 7,0 mm	6,8 x 7,8 mm	RU 7801-06 NR
	Fig. 7	6,5 x 7,5 mm	7,3 x 8,3 mm	RU 7801-07 NR
	Fig. 8	7,0 x 8,0 mm	7,8 x 8,8 mm	RU 7801-08 NR
	Fig. 9	7,5 x 8,5 mm	8,3 x 9,3 mm	RU 7801-09 NR
Satz/Set, Fig. 1-9				RU 7801-90 NR



Politzer

für Kinder
for children

	I Ø	A Ø	verchromt/ chromium- plated	rostfreier Stahl stainless steel
Fig. 1	2,0 mm	3,0 mm	RU 7802-02	RU 7802-02 NR
Fig. 2	3,0 mm	4,0 mm	RU 7802-03	RU 7802-03 NR
Fig. 3	4,0 mm	5,0 mm	RU 7802-04	RU 7802-04 NR
Satz/Set, Fig. 1-3			RU 7802-30	RU 7802-30 NR

I Ø = Innendurchmesser
Inner diameter

A Ø = Außendurchmesser
Outer diameter

**OHRSPÉKULA
EAR SPECULA**



	I Ø	A Ø	
Fig. 1	3,1 mm	4,1 mm	RU 7803-01
Fig. 2	4,3 mm	5,3 mm	RU 7803-02
Fig. 3	5,5 mm	6,5 mm	RU 7803-03
Fig. 4	6,6 mm	7,6 mm	RU 7803-04
Satz/Set, Fig. 1-3			RU 7803-30
Satz/Set, Fig. 1-4			RU 7803-40
verchromt/chromium-plated			

Erhard
für Erwachsene
for adults

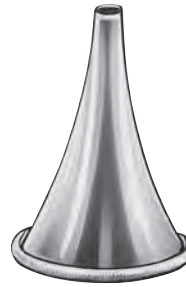

	I Ø	A Ø	verchromt chrom. plated	rostfreier Stahl stainless steel
Fig. 1	2,0 mm	3,0 mm	RU 7804-02	RU 7804-02 NR

Hartmann
für Säuglinge
for babies



	I Ø	A Ø	verchromt chrom. plated	rostfreier Stahl stainless steel
Fig. 2	3,0 mm	4,0 mm	RU 7804-03	RU 7804-03 NR
Fig. 3	4,0 mm	5,0 mm	RU 7804-04	RU 7804-04 NR
Fig. 4	5,5 mm	6,5 mm	RU 7804-05	RU 7804-05 NR
Satz/Set, Fig. 2-4			RU 7804-20	RU 7804-20 NR

Hartmann
für Kinder
for children



	I Ø	A Ø	verchromt chrom. plated	rostfreier Stahl stainless steel
Fig. 3	4,0 mm	5,0 mm	RU 7804-04	RU 7804-04 NR
Fig. 4	5,5 mm	6,5 mm	RU 7804-05	RU 7804-05 NR
Fig. 5	6,5 mm	7,5 mm	RU 7804-06	RU 7804-06 NR
Fig. 6	8,0 mm	9,0 mm	RU 7804-07	RU 7804-07 NR
Satz/Set, Fig. 4-6			RU 7804-30	RU 7804-30 NR
Satz/Set, Fig. 3-6			RU 7804-40	RU 7804-40 NR

Hartmann
für Erwachsene
for adults



	I Ø	A Ø	
Fig. 0	2,0 mm	3,0 mm	RU 7805-10
Fig. 1	3,0 mm	4,0 mm	RU 7805-11
Fig. 2	4,0 mm	5,0 mm	RU 7805-12
Fig. 3	5,0 mm	6,0 mm	RU 7805-13
Fig. 4	6,0 mm	7,0 mm	RU 7805-14
Satz/Set, Fig. 2-4			RU 7805-31
Satz/Set, Fig. 1-4			RU 7805-41
verchromt/chromium-plated			

Toyabee
für Erwachsene
for adults



	I Ø	A Ø	
Fig. 1	4,5 x 5,5 mm	5,5 x 6,5 mm	RU 7806-01
Fig. 2	5,5 x 6,5 mm	6,5 x 7,5 mm	RU 7806-02
Fig. 3	6,5 x 7,5 mm	7,5 x 8,5 mm	RU 7806-03
Fig. 4	7,5 x 8,5 mm	8,5 x 9,5 mm	RU 7806-04
Fig. 5	8,5 x 9,5 mm	9,5 x 10,5 mm	RU 7806-05
Fig. 6	9,5 x 10,5 mm	10,5 x 10,5 mm	RU 7806-06
Satz/Set, Fig. 1-6			RU 7806-60

Zöllner

Leichtmetall, schwarz eloxiert
light-metal black, anodized

I Ø = Innendurchmesser
Inner diameter A Ø = Außendurchmesser
Outer diameter

**OHR SPEKULA
EAR SPECULA**



Gruber

	I Ø	A Ø	
Fig. 1	2,8 x 3,8 mm	3,8 x 4,8 mm	RU 7807-02
Fig. 2	3,8 x 4,8 mm	4,8 x 5,8 mm	RU 7807-03
Fig. 3	5,0 x 6,2 mm	6,0 x 7,2 mm	RU 7807-05
Fig. 4	6,0 x 7,2 mm	7,0 x 8,2 mm	RU 7807-06
Satz/Set, Fig. 2-4			RU 7807-30
Satz/Set, Fig. 1-4			RU 7807-40

verchromt/*chromium-plated*



Hartmann

	I Ø	A Ø	
Fig. 1	3,0 mm	4,0 mm	RU 7809-03
Fig. 2	4,0 mm	5,0 mm	RU 7809-04
Fig. 3	5,0 mm	6,0 mm	RU 7809-05
Fig. 4	7,0 mm	8,0 mm	RU 7809-07
Satz/Set, Fig. 1-4			RU 7809-40

schwarz verchromt
black chromium-plated



Hartmann

	I Ø	A Ø	
Fig. 5	2,5 mm	8,5 mm	RU 7809-09
Fig. 6	9,0 mm	10,0 mm	RU 7809-11
Satz/Set, Fig. 5-6			RU 7809-20

schwarz verchromt
black chromium-plated



Boucheron

	I Ø	A Ø	
Fig. 1	3,5 mm	4,5 mm	RU 7811-03
Fig. 2	4,5 mm	5,5 mm	RU 7811-04
Fig. 3	5,5 mm	6,5 mm	RU 7811-05
Fig. 4	6,5 mm	7,5 mm	RU 7811-06
Fig. 5	7,6 mm	8,5 mm	RU 7811-07
Fig. 6	9,1 mm	10,0 mm	RU 7811-08
Satz/Set, Fig. 1-4			RU 7811-40

verchromt/*chromium-plated*

Metallständer für 12 Ohrspekula
Metal stand for 12 ear specula

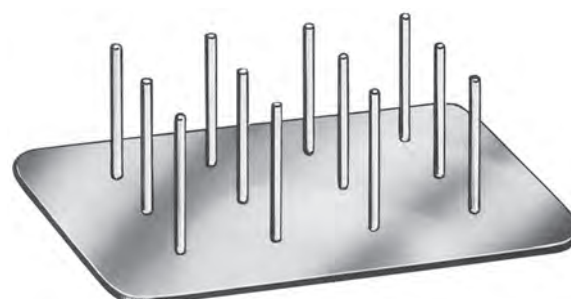

RU 7810-12

I Ø = Innendurchmesser
Inner diameter

A Ø = Außendurchmesser
Outer diameter

**OHRSPEKULA
EAR SPECULA**



Siegle

- RU 7814-00** Ohrspekula, kpl. mit 3 Spekula und Gebläse, mit Vergrößerung
Ear specula, cpl. with 3 specula and rubber bulb, with magnification
- RU 7814-50** Ohrspekula, kpl. mit 3 Spekula und Gebläse, ohne Vergrößerung
Ear specula, cpl. with 3 specula and rubber bulb, without magnification
- RU 7814-01** Siegle Lupe, allein, mit Vergrößerung
Siegle magnifying glass, only, with magnification
- RU 7814-51** Siegle Lupe, allein, ohne Vergrößerung
Siegle magnifying glass, only, without magnification
- RU 7814-99** Siegle Gebläse, allein
Siegle rubber bulb with tube, only

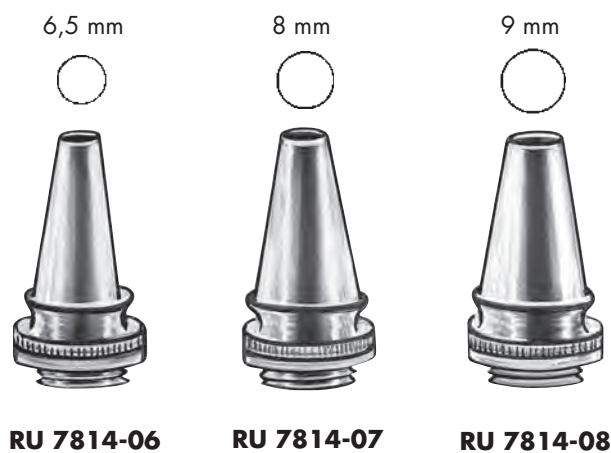

**OHR SPEKULA
EAR SPECULA**



Brünings

- Fig. 00 – 4 mm
RU 7815-04
- Fig. 0 – 4,8 mm
RU 7815-05
- Fig. 1 – 6 mm
RU 7815-06
- Fig. 2 – 7,5 mm
RU 7815-07
- Fig. 3 – 8,2 mm
RU 7815-08
- Fig. 4 – 10,5 mm
RU 7815-10
- Fig. 5 – 12,5 mm
RU 7815-12

- RU 7815-00** Ohrspekula-Set mit 4 Spekula, mit Vergrößerung (Fig. 0-3)
Ear specula set with 4 specula, with magnification (Fig. 0-3)
- RU 7815-50** Ohrspekula-Set mit 4 Spekula, ohne Vergrößerung (Fig. 0-3)
Ear specula set with 4 specula, without magnification (Fig. 0-3)
- RU 7815-16** Ohrspekula-Set mit 6 Spekula, mit Vergrößerung (Fig. 00-4)
Ear specula set with 6 specula, with magnification (Fig. 00-4)
- RU 7815-66** Ohrspekula-Set mit 6 Spekula und RU 7815-52, ohne Vergrößerung (Fig. 00-4)
Ear specula set with 6 specula and RU 7815-52, without magnification (Fig. 00-4)
- RU 7815-01** Lupe allein, mit Vergrößerung
Magnifying glass, only, with magnification
- RU 7815-51** Lupe allein, ohne Vergrößerung
Magnifying glass, only, without magnification
- RU 7815-99** Gebläse allein, mit Konusstecker
Rubber bulb and tube with cone plug
- RU 7815-52** OP-Lupenkörper mit Segmentausschnitt, ohne Vergrößerung
Magnifying glass body with segment detail, without magnification

**STIMMGABELN
TUNING FORKS**



**a¹ 440
RU 7818-00**



Hartmann



**Lucae
Hartmann**



French

C²	16			RU 7824-16
C²	32			RU 7824-32
C	64			RU 7825-01
C	128	RU 7820-00	RU 7822-00	RU 7825-02
C¹	256	RU 7820-01	RU 7822-01	RU 7825-03
C²	512	RU 7820-02	RU 7822-02	
C³	1024	RU 7820-03	RU 7822-03	
C⁴	2048	RU 7820-04	RU 7822-04	
C⁵	4096	RU 7820-05	RU 7822-05	



**Lucae
C 128**



**Hartmann
C 128**

verschiebbar bis h
variable up to h (Engl. b)
RU 7826-00 **RU 7827-00**

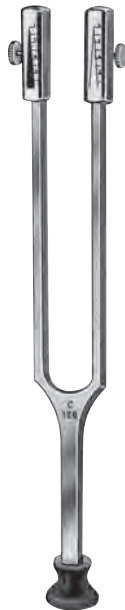

mit Dämpfer = C 64
 ohne Dämpfer = C 128
with clamps = C 64
without clamps = C 128

Rydel-Seiffer
C 64/C 128
RU 7828-00



Stimmgabel
 für neurologische Untersuchungen,
 mit Reflexhammer, Nadelrad, Pinsel
 und Nadel

*Tuning fork
 for neurological examinations,
 with percussion hammer, pin wheel,
 brush and needle*

RU 7829-00

STIMMGABELBESTECKE
TUNING FORK SETS



RU 7830-05

Satz zu 5 Stimmgabeln, enthaltend:
Set of 5 tuning forks, containing:

RU 7820-02
RU 7820-03
RU 7820-04
RU 7825-02
RU 7825-03

RU 7830-06

Satz zu 6 Stimmgabeln, enthaltend:
Set of 6 tuning forks, containing:

RU 7820-02
RU 7820-03
RU 7820-04
RU 7820-05
RU 7825-02
RU 7825-03

RU 7830-08

Satz zu 8 Stimmgabeln, enthaltend:
Set of 8 tuning forks, containing:

RU 7820-02
RU 7820-03
RU 7820-04
RU 7820-05
RU 7824-32
RU 7825-01
RU 7825-02
RU 7825-03

STIMMGABELN
TUNING FORKS



C 64
RU 7831-01



C 128
RU 7831-02



C 256
RU 7831-03



C 512
RU 7831-04



C 1024
RU 7831-05



C 2048
RU 7831-06



C 4096
RU 7831-07

Stimmgabeln aus Spezial Aluminium-Magnesium-Legierung für medizinische Zwecke z. B. für Gehörprüfungen (Luft- und Knochenleitung), für Sensibilitätsprüfungen und andere diagnostische Zwecke.

Tuning forks made of a special aluminium-magnesium-alloy, for medical purposes, such as examination of hearing (air and bone conduction), for sensibility examinations and other diagnostic purposes.

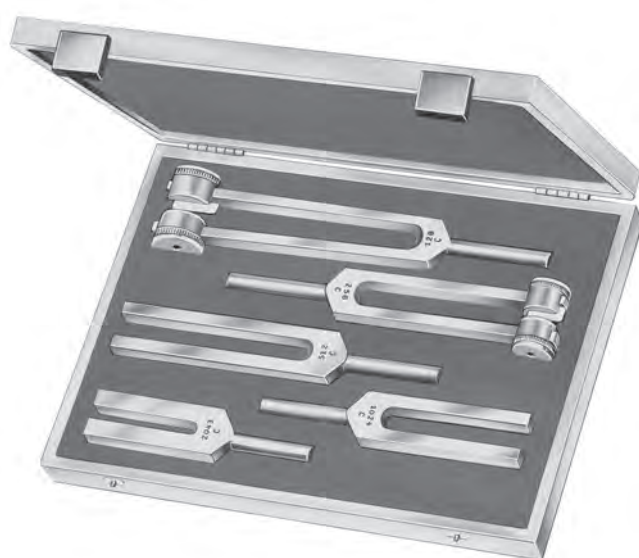

RU 7832-05

Satz zu 5 Stimmgabeln, enthaltend:
Set of 5 tuning forks, containing:

- RU 7831-02**
- RU 7831-03**
- RU 7831-04**
- RU 7831-05**
- RU 7831-06**

**LÄRMTRÖMMELN
NOISE APPARATUS**

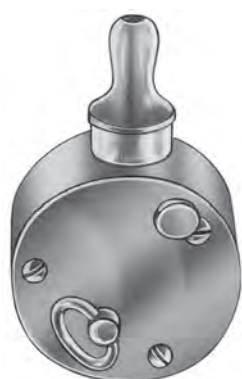

**Barany
RU 7835-00**



**Barany
(Barany-Frenzel)
RU 7836-00**

SAUGROHRE, SAUGADAPTER
SUCTION TUBES, SUCTION ADAPTERS



Hartmann
13,5 cm/5 1/4"

- Ø 2,5 mm
RU 7840-20
- Ø 3,0 mm
RU 7840-25
- Ø 3,5 mm
RU 7840-30
- Ø 4,0 mm
RU 7840-40
- Ø 5,0 mm
RU 7840-50



Itard
13 cm/5"

- Ø 3,0 mm
RU 7841-30
- Ø 3,5 mm
RU 7841-35
- Ø 4,0 mm
RU 7841-40
- Ø 4,5 mm
RU 7841-45
- Ø 5,0 mm
RU 7841-50

Saugadapter mit Saugunterbrecher
(Schlauchverbinder)
Suction adapters with cut-off
(Tube connector)



House
5,5 cm/2 1/8"
RU 7842-00



House (Fisch)
5,5 cm/2 1/8"
RU 7842-00/05



Saughandgriffe, mit Unterbrecher,
mit LUER Konus
Suction handels, with cut-off,
with LUER cone

1/1

10 cm/4"
RU 7842-00/10



1/1

10,5 cm - 4"
RU 7842-00/20

Saugset komplett
Suction set, complete

bestehend aus:
consisting of:

- RU 7842-00/21**
- 1 x **RU 7842-00/20**
 - 2 x **RU 7842-10**
 - 2 x **RU 7842-11**
 - 2 x **RU 7842-12/1**
 - 2 x **RU 7842-13/1**

Siehe Seite 197
see page 197



Saugkanüle
Suction cannula

1/1

Rosen (House)
Ø 0,5 mm
RU 7842-10

**SAUGINSTRUMENTE
SUCTION INSTRUMENTS**

- 1,5 mm ○ **RU 7844-01**
- 1,7 mm ○ **RU 7844-02**
- 2,0 mm ○ **RU 7844-03**



Barnes

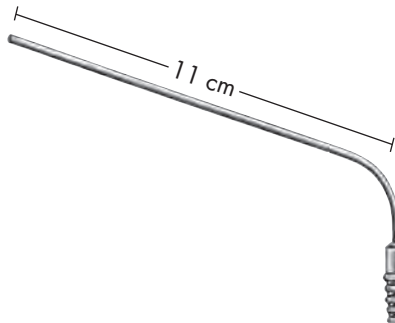

- 22,5 cm
biegsam/
malleable
○ **RU 7844-70**



Ø	Zylindrisch cylindrical		Konisch conical	
	Nutzlänge Working length 9 cm	Nutzlänge Working length 11 cm	Nutzlänge Working length 11 cm	Nutzlänge Working length 13 cm
1,0 mm	RU 7844-31			
1,5 mm	RU 7844-32			
2,0 mm	RU 7844-33			
2,5 mm		RU 7844-44		
3,0 mm		RU 7844-45	RU 7844-55	
3,5 mm			RU 7844-56	
4,0 mm		RU 7844-47		
4,5 mm				RU 7844-68
5,0 mm		RU 7844-49		

- 13 cm
biegsam/
malleable
○ **RU 7844-74**



**SAUGROHRE
SUCTION TUBES**

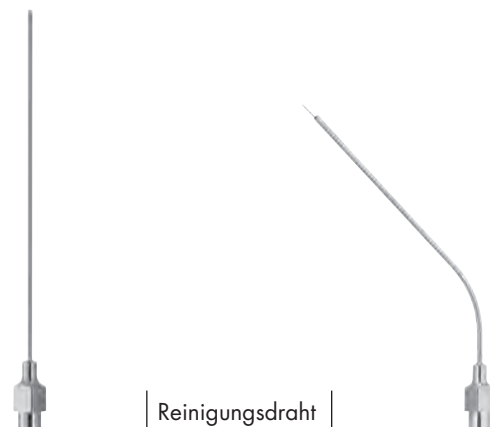

Außen Ø Outer Diam. Ø	Rosen 8 cm/3¼"	Reinigungsdraht Cleaning wire Rosen Rosen (House)	Rosen (House)
0,5 mm	RU 7842-50	RU 7842-92	RU 7842-10
0,7 mm	RU 7842-01	RU 7842-93	RU 7842-11
0,8 mm	RU 7842-51	RU 7842-93	RU 7842-11/1
0,9 mm	RU 7842-02	RU 7842-95	RU 7842-12
1,0 mm	RU 7842-52	RU 7842-95	RU 7842-12/1
1,2 mm	RU 7842-03	RU 7842-95	RU 7842-13
1,4 mm	RU 7842-53	RU 7842-95	RU 7842-13/1
1,5 mm	RU 7842-54	RU 7842-95	RU 7842-14
1,8 mm	RU 7842-55	RU 7842-96	RU 7842-18
2,0 mm	RU 7842-56	RU 7842-96	RU 7842-20
2,5 mm	RU 7842-57	RU 7842-96	RU 7842-25
3,0 mm	RU 7842-58	RU 7842-96	RU 7842-30

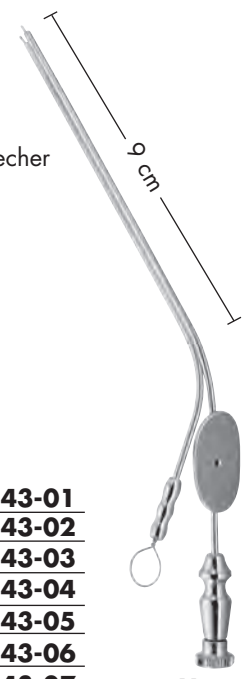

mit Saugunterbrecher
und Mandrel
with cut-off
and stylet

Saugrohr Suction tube Ø	Spülrohr irrigation tube Ø	
0,9 mm	0,7 mm	RU 7843-01
1,2 mm	0,9 mm	RU 7843-02
1,5 mm	1,2 mm	RU 7843-03
1,8 mm	1,8 mm	RU 7843-04
2,5 mm	2,0 mm	RU 7843-05
3,0 mm	2,0 mm	RU 7843-06
4,5 mm	2,0 mm	RU 7843-07

House

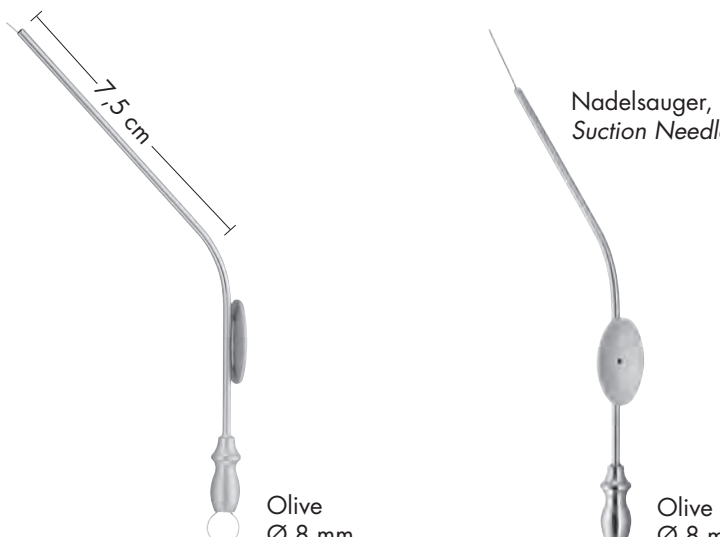

Nadelsauger,
Suction Needle

Olive
Ø 8 mm

Baron
14 cm/5½"

Olive
Ø 8 mm

Schuknecht
13 cm/5"

Ø mm	Charr./Fr.		Ø mm	Gauge	
1,0	3	RU 7845-03	0,9	20	RU 7845-20
1,5	5	RU 7845-05	0,7	22	RU 7845-22
2,3	7	RU 7845-07	0,5	24	RU 7845-24



Saugrohr,
zylindrisch aus Silber mit Mandrel,
Olive mit LUER-Anschluss
Suction tube,
cylindrical, silver, with stylet,
olive with LUER connector

10 cm/4"

biegsam/malleable

Ø mm	10 cm/4"	
0,5		RU 7846-35
0,7		RU 7846-37
1,0		RU 7846-40
1,3		RU 7846-43
1,5		RU 7846-45
2,0		RU 7846-50
2,5		RU 7846-55
3,0		RU 7846-60

Wullstein
14 cm/5½"

Ø mm	Charr./Fr.	
1,5	5	RU 7847-15
2,0	6	RU 7847-20

SAUGROHRE, SAUG- UND SPÜLKANÜLEN
SUCTION TUBES, SUCTION AND IRRIGATION CANNULAE

Ø 2,5 mm

Saugkanüle, allein mit Mandrel,
passend zu den Saugaufsätzen
RU 7848-05 - RU 7848-12
Suction cannula only, with stylet,
fitting to the detachable aspiration ends
RU 7848-05 - RU 7848-12

Abnehmbare Feinstsauger,
zu RU 7848-00
Detachable fine aspirator ends,
fitting to RU 7848-00

- Ø 0,5 mm **RU 7848-05**
- Ø 0,7 mm **RU 7848-07**
- Ø 0,9 mm **RU 7848-09**
- Ø 1,2 mm **RU 7848-12**

Zöllner
15,5 cm/6"
RU 7848-00

Fisch
zylindrisch/cylindrical
Saug-/Spülrohre
suction/irrigation cannulae

Ø Saugrohr Ø Suction tube	Ø Spülrohr Ø Irrigation tube	
4,5 mm	2,0 mm	RU 7849-45
3,0 mm	2,0 mm	RU 7849-30
2,5 mm	2,0 mm	RU 7849-25
1,8 mm	1,8 mm	RU 7849-18
1,5 mm	1,5 mm	RU 7849-15
1,0 mm	1,0 mm	RU 7849-10

10 cm/4"

Fergusson

Ø mm	Charr./Fr.	
2,0	6	RU 6421-06
2,3	7	RU 6421-07
2,5	8	RU 6421-08
3,0	9	RU 6421-09
3,3	10	RU 6421-10
3,5	11	RU 6421-11
4,0	12	RU 6421-12
5,0	15	RU 6421-15

mit Saugunterbrecher und Mandrel
Griffplatte parallel zur Biegung,
LUER-Anschluss
with cut-off and stylet
thumb piece parallel to curve,
LUER connector

Ø mm	Charr./Fr.	
1,5	5	RU 6422-15
2,0	6	RU 6422-20
2,5	8	RU 6422-25
3,0	9	RU 6422-30

Plester
19,5 cm/7 ¾"

POLYPENSCHNÜRER, POLYPENSCHLINGEN
POLYPUS SNARES, WIRE LOOPS



Krause
18 cm/7¼"
RU 7850-16



Krause-Voss
18 cm/7¼"
RU 7852-16

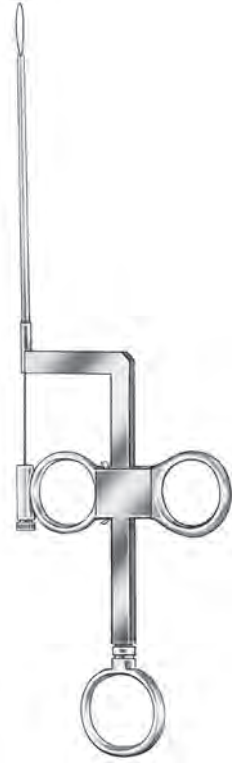

Lange-Wilde
18 cm/7¼"
RU 7854-16



10 m/33 ft.

Ø 0,3 mm **RU 7856-03**
Ø 0,4 mm **RU 7856-04**



Packung à 12 Stück
package of 1 dozen each

Ø 0,2 mm **RU 7857-02**
Ø 0,3 mm **RU 7857-03**

Packung à 100 Stück
package of 100 pieces each

Ø 0,2 mm **RU 7857-02/00**
Ø 0,3 mm **RU 7857-03/00**

OHRZÄNGCHEN, FREMDKÖRPERHEBEL
EAR FORCEPS, FOREIGN BODY LEVERS



Littauer
12 cm/4¾"
RU 7869-12



Standard
Standard
RU 7870-12



feines Modell
fine pattern
RU 7870-12/1



Hartmann
14 cm/5½"
normales Modell
standard pattern
RU 7870-14

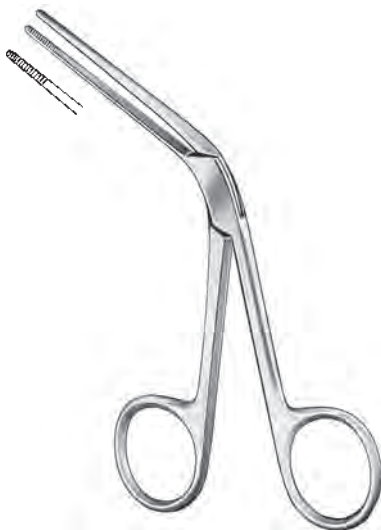

Tilley
14 cm/5½"
RU 7871-14



Buck
9 cm/3½"
RU 7872-00



Quire
8 cm/3¼"
RU 7873-00

OHRZÄNGCHEN
EAR FORCEPS



Schaftlänge
Length of shaft
8,5 cm/3¼"

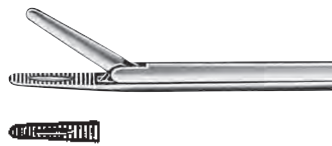

Hartmann-Noyes
RU 7878-00



RU 7879-00

8,5 cm/3¼"
14 cm/5½"



Hartmann
RU 7880-09
RU 7880-14

1:2 Zähne/teeth



Hartmann
RU 7881-09
RU 7881-14

8,5 cm/3¼"
8,5 cm/3¼"
8,5 cm/3¼"



Hartmann
RU 7882-20 ○ 2,0 mm
RU 7882-25 ○ 2,5 mm
RU 7882-30 ○ 3,0 mm



Hartmann-Citelli
RU 7883-09/02 ○ 2 mm
RU 7883-09 ○ 3 mm

OHRZÄNGCHEN
EAR FORCEPS



Strümpel-Voss
11 cm
RU 7884-11



Strümpel
8,5 cm/3³/₄" **RU 7884-09**
10 cm/4" **RU 7884-10**



Hartmann-Weingärtner
RU 7885-09

8,5 cm/3¹/₄"
8,5 cm/3¹/₄"



Hartmann
RU 7886-09



Hartmann-Wullstein
0,8 x 6 mm **RU 7887-06**
1,8 x 8 mm **RU 7887-08**



Hartmann-Wullstein
∅ 1 mm **RU 7888-01**
∅ 2 mm **RU 7888-02**

8,5 cm/3¹/₄"
8,5 cm/3¹/₄"



Hartmann
RU 7889-00



Hartmann
RU 7889-01

MIKRO-OHRZÄNGCHEN
MICRO EAR FORCEPS

















Schaftlänge 8 cm
Length of shaft 8 cm

Mikrozangen
Micro Forceps





	1,6 x 7,0 mm	Mini 0,7 x 3,5 mm	Superfein superdelicate
	RU 7890-21	RU 7890-28	
	0,8 x 4,0 mm	0,6 x 4,0 mm	0,4 x 4,0 mm
Schaftlänge Standard 8 cm length of shaft 10 cm	RU 7890-22 RU 7890-22/10	RU 7890-29	RU 7890-35
glattes Maul smooth jaw	0,8 x 4,0 mm		
	RU 7890-23		
links gebogen curved left	0,8 x 6,0 mm	0,6 x 4,0 mm	
	RU 7890-24	RU 7890-31	
rechts gebogen curved right	0,8 x 6,0 mm	0,6 x 4,0 mm	
	RU 7890-25	RU 7890-32	
aufgebogen angled up	0,8 x 4,0 mm	0,6 x 4,0 mm	0,4 x 4,0 mm
	RU 7890-26	RU 7890-33	RU 7890-36
abgebogen angled down	0,8 x 4,0 mm		
	RU 7890-27		

LÖFFELZANGEN, DRAHTBIEGEZÄNGCHEN
CUP-SHAPED FORCEPS, WIRE BENDING FORCEPS

Löffelzangen Cup-shaped forceps	
gerade <i>straight</i>	<p>0,5 x 0,6 mm</p>  <p>RU 7891-11</p> <p>0,9 x 1,1 mm</p>  <p>RU 7891-31</p>
links gebogen <i>curved left</i>	<p>0,5 x 0,6 mm</p>  <p>RU 7891-12</p> <p>0,9 x 1,1 mm</p>  <p>RU 7891-32</p>
rechts gebogen <i>curved right</i>	<p>0,5 x 0,6 mm</p>  <p>RU 7891-13</p> <p>0,9 x 1,1 mm</p>  <p>RU 7891-33</p>
aufgebogen <i>angled up</i>	<p>0,5 x 0,6 mm</p>  <p>RU 7891-14</p> <p>0,9 x 1,1 mm</p>  <p>RU 7891-34</p>
abgebogen <i>angled down</i>	<p>0,9 x 1,1 mm</p>  <p>RU 7891-35</p>

Drahtbiegezüngchen Wire Bending Forceps	
leicht nach unten gebogen <i>slightly curved downwards</i>	<p>Mc Gee</p> <p>0,8 x 3,5 mm</p>  <p>RU 7891-45</p>
links gebogen <i>curved left</i>	 <p>RU 7891-46</p>
rechts gebogen <i>curved right</i>	 <p>RU 7891-47</p>
leicht nach unten gebogen <i>slightly curved downwards</i>	<p>Schuknecht</p>  <p>RU 7891-49</p>
gerade/ <i>straight</i>	<p>Mikrozangen Micro forceps</p> <p>Greven</p> <p>0,8 x 5,0 mm</p>  <p>RU 7891-36</p>











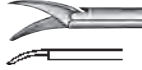

Hammerkopfstanze
Malleus Nipper

oben schneidend <i>upwards cutting</i>	<p>Dieter</p>  <p>RU 7891-50</p>
unten schneidend <i>downwards cutting</i>	<p>Dieter</p>  <p>RU 7891-51</p>
rechts schneidend <i>cutting to the right</i>	<p>Dieter</p>  <p>RU 7891-52</p>
links schneidend <i>cutting to the left</i>	<p>Dieter</p>  <p>RU 7891-53</p>



MIKRO-OHRSCHEREN
MICRO-EAR SCISSORS

Mikroscheren
Micro scissors

gerade, spitz/spitz <i>straight, sharp/sharp</i>		Bellucci 4,0 mm	gerade <i>straight</i>		Bellucci 5,5 mm
Schaftlänge 8 cm <i>length of shaft 10 cm</i>		RU 7892-11 RU 7892-11/00	Schaftlänge 8 cm <i>length of shaft</i>		RU 7892-12
gerade, spitz/stumpf <i>straight, sharp/blunt</i>			aufgebogen <i>angled up</i>		Bellucci 5,5 mm
8 cm		RU 7892-11/01	8 cm		RU 7892-13
aufgebogen, spitz/spitz <i>angled up, sharp/sharp</i>			links gebogen <i>curved left</i>		Bellucci 5,5 mm
8 cm		RU 7892-11/02	8 cm		RU 7892-14
rechts gebogen, spitz/spitz <i>curved right, sharp/sharp</i>			rechts gebogen <i>curved right</i>		Bellucci 5,5 mm
8 cm		RU 7892-11/03	8 cm		RU 7892-15
links gebogen, spitz/spitz <i>curved left, sharp/sharp</i>			gerade <i>straight</i>		Shea 7,0 mm
8 cm		RU 7892-11/04	8 cm		RU 7892-16
gerade, fein, spitz/spitz <i>straight, delicate</i>			links gebogen <i>curved left</i>		Shea 7,0 mm
8 cm		RU 7892-11/13	8 cm		RU 7892-17
			rechts gebogen <i>curved right</i>		Shea 7,0 mm
			8 cm		RU 7892-18

MIKRO-OHRZANGEN
MICRO EAR FORCEPS



Schaftlänge 8 cm
Length of shaft 8 cm

glattes Maul
smooth jaw

0,5 mm

gerade
straight

rechts gebogen
curved right

links gebogen
curved left

aufgebogen, horizontal
angled up, horizontal

abgebogen, horizontal
angled down, horizontal

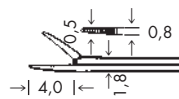

RU 7893-01/04

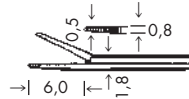

RU 7893-01/06

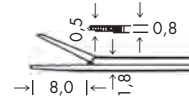

RU 7893-01/08

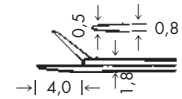

RU 7893-09/04

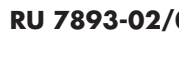

RU 7893-02/04



RU 7893-03/04

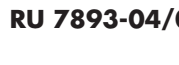

RU 7893-04/04



RU 7893-05/04

glattes Maul
smooth jaw

0,3 mm

gerade
straight

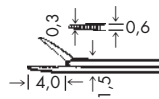

RU 7893-11/04

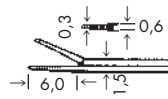

RU 7893-11/06

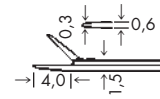

RU 7893-19/04

Diese Zängchen sind gegen Aufpreis auch in schwarz verchromter Ausführung lieferbar.
These micro forceps can also be supplied in black-chromed finish for a slightly higher price.

MIKRO-OHRZANGEN
MICRO EAR FORCEPS

Schaftlänge 8 cm
Length of shaft 8 cm

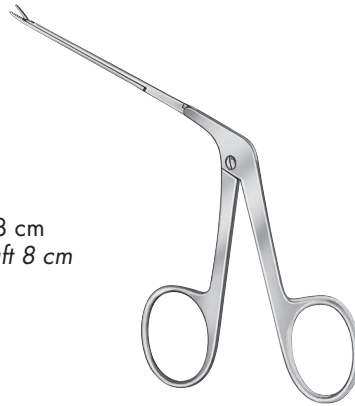

glattes Maul
smooth jaw

0,5 mm

gerade
straight

rechts gebogen
curved right

links gebogen
curved left

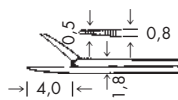

RU 7893-01/04

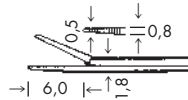

RU 7893-01/06

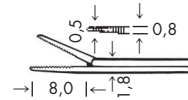

RU 7893-01/08

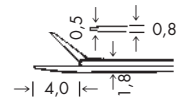

RU 7893-09/04

0,3 mm

gerade
straight

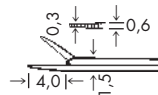

RU 7893-11/04

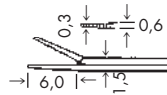

RU 7893-11/06

Diese Zängchen sind gegen Aufpreis auch in schwarz verchromter Ausführung lieferbar.
These micro forceps can also be supplied in black-chromed finish for a slightly higher price.

MIKRO-INSTRUMENTE, OP-GESTELL, SCHUTZHÜLSE
MICRO INSTRUMENTS, OP-RACK, PROTECTIVE SLEEVE



Schaftlänge 8 cm
Length of shaft 8 cm

Crurotomie-Schere
Crurotomy scissors



links öffnend
opens to the left

Fisch
RU 7893-50/02

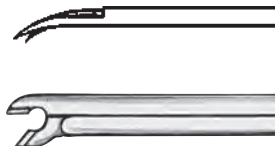

rechts öffnend
opens to the right

Fisch
RU 7893-50/01



Schaftlänge 8 cm
Length of shaft 8 cm

Mc Gee/Fisch
RU 7893-52
Drahtbiege-Zängchen
Wire/- bending forceps

Operationsgestell zum Aufbewahren und Sterilisieren von 6 Ohrzängchen
OP-rack for storage and sterilization of 6 ear forceps

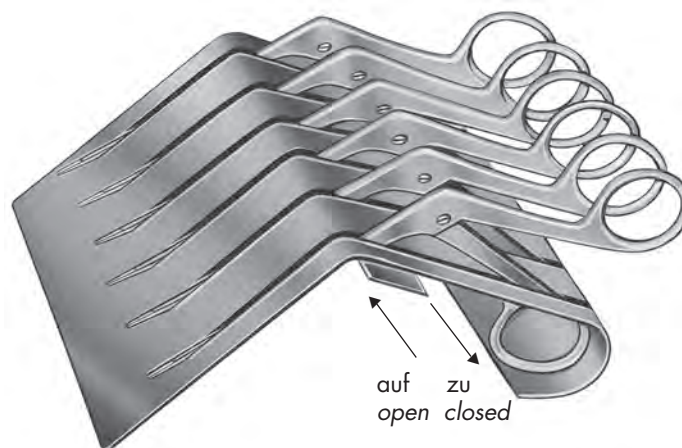

RU 7893-60/06



11,5 cm
RU 8882-01
Schutzhülse, Teflon,
autoklavierbar
Protective sleeve, Teflon,
autoclavable

TUBENINSTRUMENTARIUM
TUBE INSTRUMENTATION

Einführinstrument für Ventilation-Tuben
Inserters for ventilation tubes

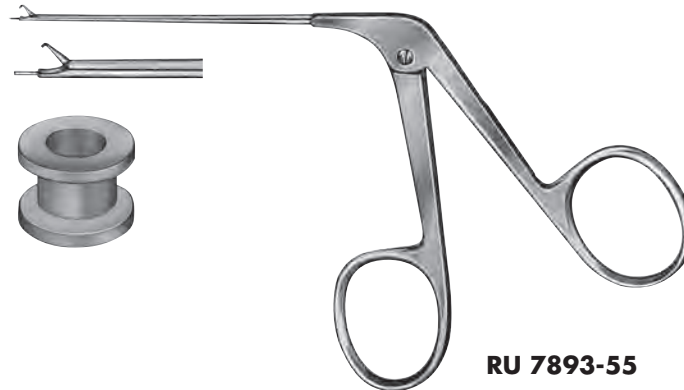

RU 7893-55

Einführinstrument für T-Tuben
Inserters for T-tubes

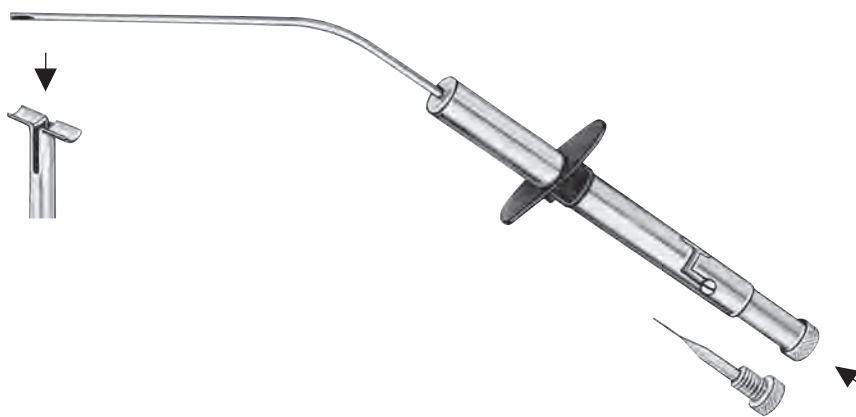

Einführinstrument für C-Flex,
T-Form-Paukenröhrchen

Exaktes Einsetzen von T-Form-Pauken-
röhrchen durch 6, 9 und 12 mm lange,
3-stufige Hubwegvorrichtung

Inserters for C-Flex, T-shaped vent tubes

*Precise insertion of t-shaped vent tubes
thanks to the 6, 9 and 12 mm long 3-step
insertion device*

RU 7893-56

Längenmessinstrument
Microsurgical sliding gauge

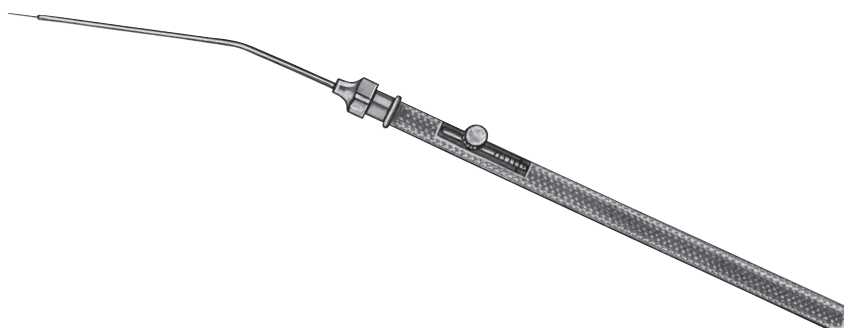

Längenmessinstrument
für Stapedektomie und Tympanoplastik
mit 0-9 mm Mess-Skala, autoklavierbar,
18 cm

*Microsurgical sliding gauge
for stapedectomy and tympanoplasty
with 0-9 mm measuring scale,
autoclavable 18 cm*

RU 7893-57

Myringotome entnehmen Sie bitte Seite 239
For myringotomes please refer to page 239

PAUKENRÖHRCHEN VENTILATION TUBES

Kurzzeitige Anwendung Short-term application

Shepard Grommet

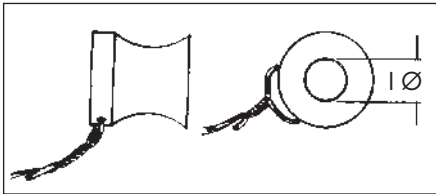

Können leicht mit einem Fasszängchen oder Tubeneinführungsinstrument durch eine Inzision ins Trommelfell eingesetzt werden. (siehe RU 7893-55, Seite 213)

*Can be easily inserted with forceps or tube inserter through incision in drum.
(see RU 7893-55, page 213)*

Verpackungseinheit / Units per box: 6 Stück/pieces

	Material Material	l Ø mm	Bezeichnung Description
RU 7950-01/01	Fluoroplastik/ <i>Fluoroplastic</i>	1,02	–
RU 7950-01/02	Fluoroplastik/ <i>Fluoroplastic</i>	1,02	mit Draht/ <i>with wire</i>
RU 7950-01/03	Fluoroplastik/ <i>Fluoroplastic</i>	1,14	–
RU 7950-01/04	Fluoroplastik/ <i>Fluoroplastic</i>	1,14	mit Draht/ <i>with wire</i>
RU 7950-01/05	Silikon/ <i>Silicone</i>	1,02	mit Lasche/ <i>with tab</i>

Donaldson

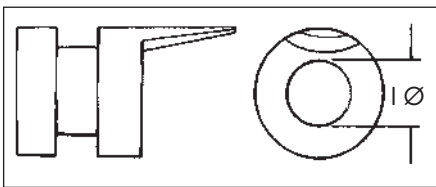

Flansche verhindern die Migration und Extrusion.
Ein weites Lumen begünstigt die Drainage.

*Flanges prevent migration and extrusion.
Large lumen promotes good ventilation.*

Verpackungseinheit / Units per box: 6 Stück/pieces

	Material Material	l Ø mm	Bezeichnung Description
RU 7950-02/01	Silikon/ <i>Silicone</i>	1,14	–
RU 7950-02/02	Silikon/ <i>Silicone</i>	1,14	mit Lasche/ <i>with tab</i>
RU 7950-02/03	Silikon, weich/ <i>soft silicone</i>	1,14	–
RU 7950-02/04	Ultrasil/ <i>Ultrasil</i>	1,14	–

Mittelfristige Anwendung Middle-term application

Collar Button

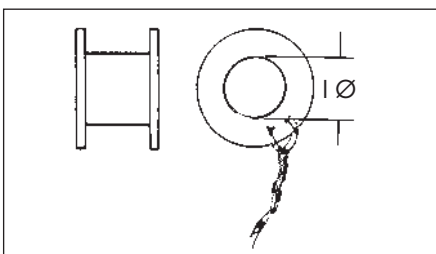

Kragenknopfförmige Paukendrainage für die Behandlung chronischer Otitis media.
A „collar-button“ shaped ventilation tube for treatment of chronic, serious otitis media.

Verpackungseinheit / Units per box: 6 Stück/pieces

	Material Material	l Ø mm	Bezeichnung Description
RU 7950-10/01	Fluoroplastik/ <i>Fluoroplastic</i>	1,27	–
RU 7950-10/02	Fluoroplastik/ <i>Fluoroplastic</i>	1,27	mit Draht/ <i>with wire</i>

Reuter Bobbin

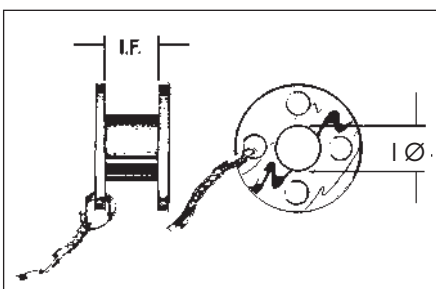

Diese spulenförmige Drainage hat einen breiten Flansch, der ein Extrusion verhindert.
The ventilation tube features a wide flange to prevent extrusion.

Verpackungseinheit / Units per box: 6 Stück/pieces

	Material Material	l Ø mm	Bezeichnung Description
RU 7950-11/01	Fluoroplastik/ <i>Fluoroplastic</i>	1,14	mit Draht/ <i>with wire</i>
RU 7950-11/02	Fluoroplastik/ <i>Fluoroplastic</i>	1,14	–
RU 7950-11/03	Fluoroplastik/ <i>Fluoroplastic</i>	1,27	–
RU 7950-11/04	rostfr. Stahl/ <i>stainless steel</i>	1,14	–
RU 7950-11/05	rostfr. Stahl/ <i>stainless steel</i>	1,27	–
RU 7950-11/06	rostfr. Stahl/ <i>stainless steel</i>	1,00	–

PAUKENRÖHRCHEN VENTILATION TUBES

Langfristige Anwendung Long-term application

Tuebinger Paukenröhrchen

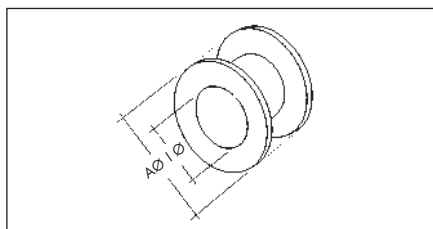

Verpackungseinheit / Units per box: 6 Stück/pieces

	Material Material	I Ø mm	AD Ø mm OD Ø mm
RU 7950-15/01	silber-vergoldet/silver plated	1,25	2,55
RU 7950-15/02	silber-vergoldet/silver plated	1,25	2,55 mit Draht/with wire
RU 7950-15/03	silber-vergoldet/silver plated	1,50	2,80
RU 7950-15/04	silber-vergoldet/silver plated	1,50	2,80 mit Draht/with wire
RU 7950-16/01	Titan/Titanium ASTM F67	1,25	2,55
RU 7950-16/02	Titan/Titanium ASTM F67	1,25	2,55 mit Draht/with wire
RU 7950-16/03	Titan/Titanium ASTM F67	1,50	2,80
RU 7950-16/04	Titan/Titanium ASTM F67	1,50	2,80 mit Draht/with wire

Paparella

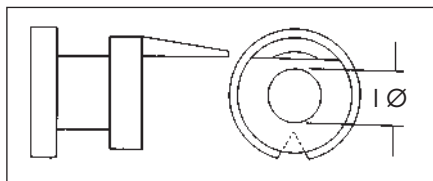

Der innere Flansch ist mit einer Kerbe versehen und ermöglicht eine „twist-in“ Einsetzung. Sehr dauerhaft und haltbar bei langfristiger Implantation.

Notched inner flange for „twist-in“ insertion. Very stable for long-term implantation.

Verpackungseinheit / Units per box: 6 Stück/pieces

	Material Material	I Ø mm	Bezeichnung Description
RU 7950-20/01	Silikon/Silicone	1,02	mit Lasche/with tab
RU 7950-20/02	Silikon/Silicone	1,27	mit Lasche/with tab
RU 7950-20/03	Silikon/Silicone	2,03	mit Lasche/with tab
RU 7950-20/04	Ultrasil/Ultrasil	1,02	mit Lasche/with tab

T-förmig

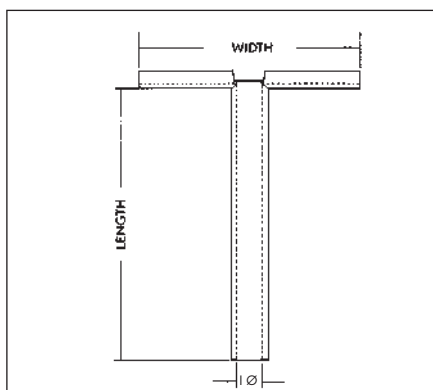

T-Tube mit flexiblen Flanschen zur Langzeit-Ventilation. Einfache Einführung mit **RUDOLF** T-Tube-Einführungsinstrument (RU 7893-56, Seite 212).

Die T-Tube besteht aus blauem Silikon und ist kürzbar.

T-tube with soft flanges for a long-term ventilation. The T-tube is easily inserted with the **RUDOLF** T-tube inserter (RU 7893-56, page 212).

The T-tube is made of blue silicone rubber and is easily trimmed.

Verpackungseinheit / Units per box: 6 Stück/pieces

	Material Material	I Ø mm	Abmessungen Dimensions
RU 7950-21/01	Silikon/Silicone	1,14	12 x 9,8 mm
RU 7950-21/02	Silikon, weich/soft silicone	1,14	12 x 9,8 mm
RU 7950-21/03	Ultrasil/Ultrasil	1,14	12 x 9,8 mm

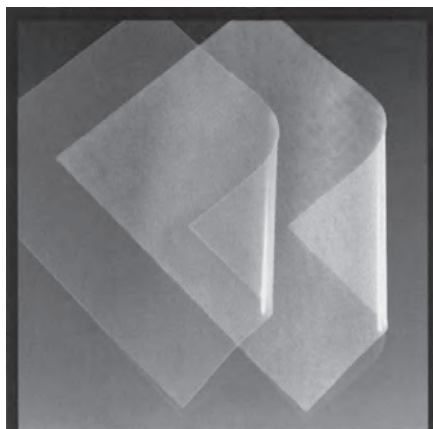

Silikon-Folien für medizinische Zwecke

Silicone sheeting for medical purpose

	Abmessungen Dimensions	Beschreibung Description
RU 7950-17/01	200 x 150 x 0,175 mm	unsteril, verstärkt non sterile, reinforced
RU 7950-17/02	200 x 150 x 0,125 mm	unsteril, unverstärkt non sterile, non-reinforced



Bei dieser Katalog-Auflage handelt es sich um einen Nachdruck mit geringfügigen Änderungen; daher entfällt der ursprüngliche Inhalt auf dieser Seite.

This catalogue edition is a reprint with minor amendments. This is why the initial content of this page has been removed.



Bei dieser Katalog-Auflage handelt es sich um einen Nachdruck mit geringfügigen Änderungen; daher entfällt der ursprüngliche Inhalt auf dieser Seite.

This catalogue edition is a reprint with minor amendments. This is why the initial content of this page has been removed.



Bei dieser Katalog-Auflage handelt es sich um einen Nachdruck mit geringfügigen Änderungen; daher entfällt der ursprüngliche Inhalt auf dieser Seite.

This catalogue edition is a reprint with minor amendments. This is why the initial content of this page has been removed.



Bei dieser Katalog-Auflage handelt es sich um einen Nachdruck mit geringfügigen Änderungen; daher entfällt der ursprüngliche Inhalt auf dieser Seite.

This catalogue edition is a reprint with minor amendments. This is why the initial content of this page has been removed.

INSTRUMENTENSÄTZE STAPEDOTOMIE / STAPEDEKTOMIE
INSTRUMENT SETS FOR STAPEDOTOMY / STAPEDECTOMY

Instrumente für die Stapedektomie
Instruments for stapedectomy



RU 7951-01

Das Set besteht aus 14 Instrumenten (17 cm) für die Stapedektomie

The kit includes 14 instruments (6¾") for stapedectomy.

RU 7951-20 bis RU 7951-32 +
RU 7893-14 in Tray **RU 7951-11**

Instrumente für die Stapedotomie
Instruments for stapedotomy

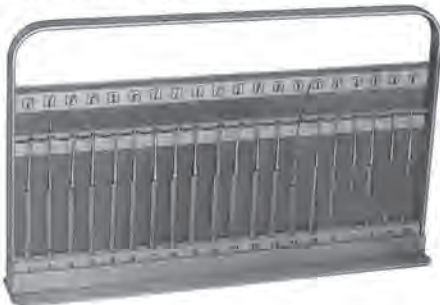

RU 7951-02

Das Set besteht aus 14 Instrumenten für die Stapedektomie und 6 Instrumenten (Perforatoren) für die Stapedotomie (17 cm)

This kit includes 14 instruments for stapedectomy and 6 instruments (Perforators) for stapedotomy (6¾")

RU 7951-20 bis RU 7951-45 +
RU 7893-14 in Tray **RU 7951-12**

	RU 7951-20	Chirurgisches Messer für Ohrkanal-Inzisionen <i>Surgical knife for ear canal incisions</i>
	RU 7951-21	Longitudinal-Messer für Ohrkanal <i>Longitudinal knife for ear canal</i>
	RU 7951-22	Rundmesser, gewinkelt <i>Decollator, angled, Ø 1.70 mm</i>
	RU 7951-23	Rundmesser, klein, gewinkelt <i>Decollator, small, angled, Ø 1.70 mm, 135°</i>
	RU 7951-24	Venen-Dissektor, kugelförmig, <i>Vein dissector, ball-shaped, 1.0x0.65 mm</i>
	RU 7951-25	Haken, groß <i>Hook, large, 2.0 mm/0.35 mm</i>
	RU 7951-26	Exartikulations-Instrument, scharf, <i>Disarticulation instrument, sharp edges</i>
	RU 7951-27	Nadel, gerade, gewinkelt <i>Needle, straight, angled, Ø 0.5 mm, 1 mm</i>
	RU 7951-28	Mikro-Haken <i>Micro hook, 0.35 mm, 0.10 mm</i>
	RU 7951-29	Elevator, flach, scharf, vorwärts schneidend <i>Elevator, flat, sharp, forwards, 0.5/0.15 mm</i>
	RU 7951-30	Elevator, flach, scharf, rückwärts schneidend <i>Elevator, flat, sharp, backward, 0.5/0.15 mm</i>
	RU 7951-31	Kürette, scharf, klein <i>Curette, sharp, small, 2.4x1.6 mm</i>
	RU 7951-32	Kürette, scharf, groß <i>Curette, sharp, large, 3.0x2.0 mm</i>
	RU 7893-14	Mikrochirurgisches Messinstrument <i>Microsurgical measuring device, 19 cm/7½"</i>
	RU 7951-40	Perforator, 1.0 mm, Ø 0.3 mm
	RU 7951-41	Perforator, 1.0 mm, Ø 0.4 mm
	RU 7951-42	Perforator, 1.0 mm, Ø 0.5 mm
	RU 7951-43	Perforator, 1.0 mm, Ø 0.6 mm
	RU 7951-44	Perforator, 1.0 mm, Ø 0.7 mm
	RU 7951-45	Perforator, 1.0 mm, Ø 0.9 mm

Alle Instrumente sind gemäß ihrer Position im Kit nummeriert. Eine vergrößerte Abbildung der Instrumentenspitzen erleichtert deren Handhabung. Der sichere Transport sowie die Sterilisation werden durch den bayonettartigen Einsatz, welcher die Instrumente fixiert, gewährleistet. Autoklavierbarer, säurebeständiger Container aus eloxiertem Aluminium und rostfreiem Stahl.

Each instrument is marked with the number corresponding to its position in the container. On the tip protection band, a silkscreened enlargement of the tip of the instrument is clearly visible, permitting easy identification of each instrument. For transport and sterilization, a cover with a bayonet insertion closes the box, locking the instruments in place and protecting them against damage.

Dry-sterilizable, acid resistant container, made of anodized aluminum and stainless steel.

- ✓ rostfreier Stahl
- ✓ Vakuum-wärmebehandelt
- ✓ Patentierte, nicht reflektierende Oberfläche
- ✓ Handgearbeitet unter mikroskopischer Sicht

- ✓ stainless steel
- ✓ Vacuum heat treatment
- ✓ Patented non-reflective surface
- ✓ Handmade under microscope

MIKROZANGEN UND -SCHEREN
MICRO FORCEPS AND SCISSORS

Schaft Ø 0,9 mm
Shaft Ø 0,9 mm



Mikrozangen
Micro Forceps

gerade
straight

4 mm



8 cm/3¼" **RU 7894-01**
16 cm/6¼" **RU 7894-01/16**

6 mm



RU 7894-03
RU 7894-03/16

aufgebogen
angled up



8 cm **RU 7894-02**
16 cm **RU 7894-02/16**

Löffelzangen
Cup-shaped Forceps

gerade
straight



oval
oval cup jaws



Ø 1 mm 8 cm **RU 7894-11**
16 cm **RU 7894-11/16**

RU 7894-12
RU 7894-12/16

Ø 2,5 mm 16 cm **RU 7894-13/16**

Mikro-Scheren
Micro Scissors

gerade
straight



8 cm/3¼" **RU 7894-21**
16 cm/6¼" **RU 7894-21/16**

Pinzettenzängchen **Heermann**
Finest grasping forceps

gerade
straight



8 cm/3¼" **RU 7894-31**

aufgebogen
angled up



8 cm/3¼" **RU 7894-22**
16 cm/6¼" **RU 7894-22/16**

rechts gebogen
curved right



8 cm/3¼" **RU 7894-33**

rechts gebogen
curved right



8 cm/3¼" **RU 7894-23**
16 cm/6¼" **RU 7894-23/16**

links gebogen
curved left



8 cm/3¼" **RU 7894-34**

links gebogen
curved left



8 cm/3¼" **RU 7894-24**
16 cm/3¼" **RU 7894-24/16**

horizontal
horizontal



8 cm/3¼" **RU 7894-35**

MIKRO-SCHEREN, -STANZEN, -ZÄNGCHEN
MICRO SCISSORS, NIPPERS, FORCEPS

Schaft Ø 1,5 mm
Shaft Ø 1,5 mm

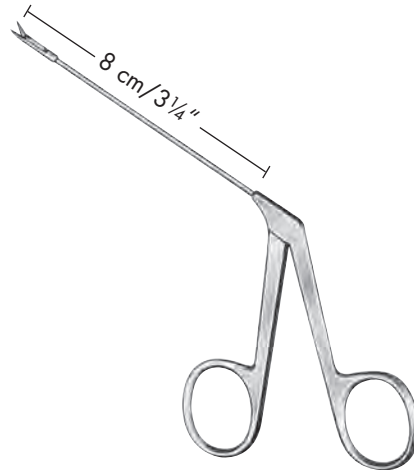

Mikroscheren
Micro scissors

gerade, spitz/spitz
straight, sharp/sharp



RU 7894-60/01

aufgebogen, stumpf/stumpf
angled up, blunt/blunt



RU 7894-60/02

links gebogen, spitz/spitz
curved left, sharp/sharp



RU 7894-60/03

rechts gebogen, spitz/spitz
curved right, sharp/sharp



RU 7894-60/04

horizontal schneidend
horizontal cutting



RU 7894-60/05

Mikrostanzen
Micro Nippers

nach oben schneidend
upwards cutting



RU 7894-60/10

nach unten schneidend
downwards cutting



RU 7894-60/11

Mikro-Drahtbiegezängchen
Micro Wire Bending Forceps

nach unten gebogen
curved down



RU 7894-60/15

nach unten gebogen
curved down



RU 7894-60/16

MIKRO-LÖFFELZÄNGCHEN
MICRO CUP-SHAPED FORCEPS

Schaft Ø 1,5 mm
Shaft Ø 1,5 mm

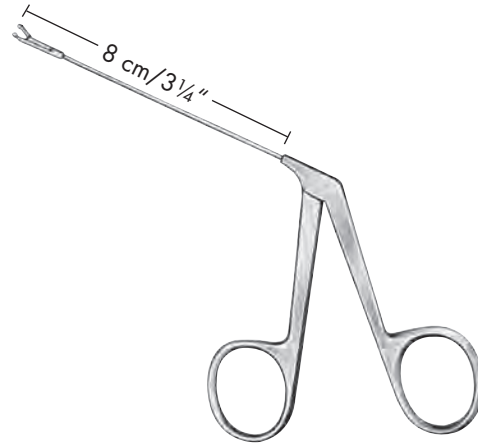

gerade, oval,
straight, oval
0,9 x 1,0 mm



RU 7894-61/01

aufgebogen, oval
angled up, oval
0,9 x 1,0 mm



RU 7894-61/02

gerade, oval,
straight, oval
0,8 x 1,3 mm



RU 7894-61/06

links gebogen, oval
curved left, oval
0,8 x 1,3 mm



RU 7894-61/07

rechts gebogen, oval
curved right, oval
0,8 x 1,3 mm



RU 7894-61/08

gerade, rund
straight, round
Ø 1,0 mm

Wullstein



RU 7894-61/12

gerade, oval,
straight, oval
1,7 x 2,5 mm

Wullstein



RU 7894-61/16

MIKRO-ZÄNGCHEN
MICRO FORCEPS

Schaft Ø 1,5 mm
Shaft Ø 1,5 mm

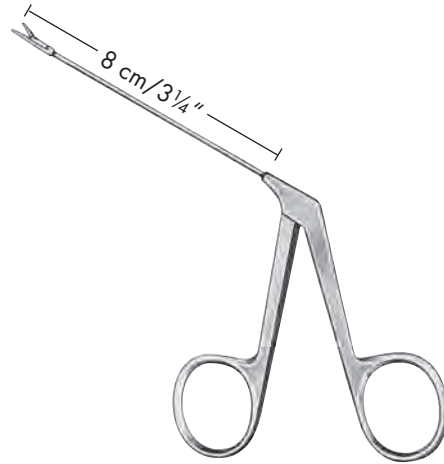

gerade
straight
0,8 x 3,5 mm



RU 7894-62/01

65° nach oben
curved up 65°
0,8 x 3,5 mm



RU 7894-62/02

45° nach unten
curved down 45°
0,8 x 3,5 mm



RU 7894-62/03

gerade
straight
1 x 5 mm



RU 7894-62/08

links gebogen
curved left
1 x 5 mm



RU 7894-62/09

rechts gebogen
curved right
1 x 5 mm



RU 7894-62/10

gerade
straight
1,5 x 6 mm



RU 7894-62/14

MIKROSCHEREN UND -ZANGEN
MICRO SCISSORS AND FORCEPS



17 cm/6¾"

aufgebogen
angled up



RU 8860-01

gerade
straight



RU 8860-02

Mikro-Scheren
Micro Scissors



RU 8861-01



RU 8861-02

Mikrozangen
Micro Forceps



RU 8862-01



RU 8862-02

Löffelzangen
Cup-shaped forceps

MIKROCHIRURGIE – MESSER
MICRO SURGERY KNIVES



Rollmesser
parallel zum Schaft
Roller knifi
blade parallel to shaft

Schuknecht
16 cm/6¼"
RU 7906-01/01



Rollmesser
rechtwinklig zum Schaft
Roller knifi
blade right angled to shaft

Schuknecht
16 cm/6¼"
RU 7906-01/02



Schuknecht
16 cm/6¼"
RU 7906-01/03



Wullstein
16 cm/6¼"
RU 7906-01/04



Tabb
16 cm/6¼"
RU 7906-01/05

MIKROCHIRURGIE – MESSER
MICRO SURGERY KNIVES



Plester
16 cm/6¼"

3,5 x 2,5 mm



RU 7906-01/06

4,0 x 2,0 mm



RU 7906-01/07

4,5 x 2,5 mm



RU 7906-01/08



RU 7906-02/01



RU 7906-02/02



mittlere Biegung
medium curve

RU 7906-02/03



stark gebogen
strang curve

RU 7906-02/04

MIKROCHIRURGIE – MESSER
MICRO SURGERY KNIVES

45°



Ø

1,0 mm	RU 7906-03/10
1,4 mm	RU 7906-03/14
1,6 mm	RU 7906-03/16
2,0 mm	RU 7906-03/20
2,3 mm	RU 7906-03/23
2,6 mm	RU 7906-03/26
2,8 mm	RU 7906-03/28
3,0 mm	RU 7906-03/30

Rosen
16 cm/6¼"

0°



Ø

1,0 mm	RU 7906-04/10
1,5 mm	RU 7906-04/15
2,0 mm	RU 7906-04/20
2,3 mm	RU 7906-04/23
2,5 mm	RU 7906-04/25

16 cm/6¼"

90°



Ø

1,0 mm	RU 7906-05/10
1,5 mm	RU 7906-05/15
2,0 mm	RU 7906-05/20
2,3 mm	RU 7906-05/23
2,5 mm	RU 7906-05/25

MIKROCHIRURGIE – MESSER
MICRO SURGERY KNIVES



3 mm
16 cm/6¼"
RU 7906-06/30

Rundschnittmesser für Periost
Round cutting knife for periost



Rosen
16 cm/6¼"
RU 7906-07/16

Lanzettenmesser
Knife and elevator



Beales
17 cm/6¾"
RU 7906-08/17

Sehnenmesser
Tendon knife



Fisch
16 cm/6¼"
RU 7906-09/16

Neurektomie-Messer
Neurectomy knife



Fisch
16 cm/6¼"
RU 7906-10/16

Tenotom
Tenotome

MIKROCHIRURGIE – NADELN UND HÄKCHEN
MICRO SURGERY NEEDLES AND HOOKS



16 cm/6¼"



Wullstein
RU 7907-01/01



Wullstein
RU 7907-01/02



Wullstein
RU 7907-01/03



Wullstein
RU 7907-01/04



Fisch
0,2 mm
RU 7907-02/02

Plester
0,6 mm
RU 7907-02/06



25°
0,3 mm **RU 7907-03/03**
0,6 mm **RU 7907-03/06**
1,0 mm **RU 7907-03/10**



Shambaugh
45°
0,3 mm **RU 7907-04/03**
0,4 mm **RU 7907-04/04**
0,6 mm **RU 7907-04/06**
0,8 mm **RU 7907-04/08**
1,0 mm **RU 7907-04/10**
1,2 mm **RU 7907-04/12**
1,5 mm **RU 7907-04/15**
2,0 mm **RU 7907-04/20**
2,5 mm **RU 7907-04/25**



Shambaugh
90°
0,3 mm **RU 7907-05/03**
0,4 mm **RU 7907-05/04**
0,6 mm **RU 7907-05/06**
0,8 mm **RU 7907-05/08**
1,0 mm **RU 7907-05/10**
1,2 mm **RU 7907-05/12**
1,5 mm **RU 7907-05/15**
2,0 mm **RU 7907-05/20**
2,5 mm **RU 7907-05/25**



0,5 mm **RU 7907-06/05**
1,0 mm **RU 7907-06/10**

MIKROCHIRURGIE – NADELN UND HÄKCHEN
MICRO SURGERY NEEDLES AND HOOKS



16 cm/6¼"
RU 7907-07/16



Fisch
16 cm/6¼"
Ø 0,3 mm **RU 7907-08/03**
Ø 0,4 mm **RU 7907-08/04**
Ø 0,5 mm **RU 7907-08/05**
Ø 0,6 mm **RU 7907-08/06**

Perforator
Perforator

45°



Plester
16 cm/6¼"
RU 7907-09/45

90°



Plester
16 cm/6¼"
RU 7907-09/90
Antrumhäkchen
Antrum hook



16 cm/6¼"



90°

0,3 mm **RU 7907-10/03**
0,6 mm **RU 7907-10/06**
1,0 mm **RU 7907-10/10**



90°

0,3 mm **RU 7907-11/03**
0,6 mm **RU 7907-11/06**
1,0 mm **RU 7907-11/10**



McGee

0,5 mm **RU 7907-12/05**
1,0 mm **RU 7907-12/10**



McGee

0,5 mm **RU 7907-13/05**
1,0 mm **RU 7907-13/10**

MIKROCHIRURGIE – NADELN UND HÄKCHEN
MICRO SURGERY NEEDLES AND HOOKS



16 cm/6¼"



Barbara
RU 7907-15/01



Rosen
RU 7907-16/01



25°
0,3 mm **RU 7907-18/03**
0,6 mm **RU 7907-18/06**
1,0 mm **RU 7907-18/10**



25°
0,3 mm **RU 7907-19/03**
0,6 mm **RU 7907-19/06**
1,0 mm **RU 7907-19/10**



45°
0,3 mm **RU 7907-20/03**
0,6 mm **RU 7907-20/06**
1,0 mm **RU 7907-20/10**



45°
0,3 mm **RU 7907-21/03**
0,6 mm **RU 7907-21/06**
1,0 mm **RU 7907-21/10**

MIKROCHIRURGIE – DIVERSES INSTRUMENTARIUM
MICRO SURGERY – VARIOUS INSTRUMENTS



Fisch

16 cm/6¼
Dissektoren
Dissectors



RU 7908-01/01



RU 7908-01/02



RU 7908-01/03



RU 7908-01/04



Rosen

19 cm/7¼

1,5 mm 2,5 mm
RU 7908-02/15 **RU 7908-02/25**

Raspatorien
Raspatories

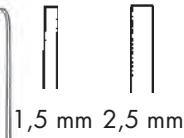

Rosen

16 cm/6¼



RU 7908-04/01



RU 7908-04/02



RU 7908-04/03



RU 7908-04/04



RU 7908-04/05



RU 7908-04/06



House

16 cm/6¼"
Meßsonden
Measuring rods



3,5 mm
RU 7908-06/35



4,0 mm
RU 7908-06/40



4,5 mm
RU 7908-06/45



5,0 mm
RU 7908-06/50

MIKROCHIRURGIE – DIVERSES INSTRUMENTARIUM
MICRO SURGERY – VARIOUS INSTRUMENTS



16 cm/6¼"
RU 7908-07/16

Meßsonde
Measuring probe

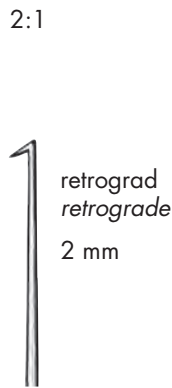

Plester
15,5 cm/6"
RU 7908-08/02



Fisch
16,5 cm/6½"
RU 7908-10/16

Meßinstrument
Measuring instrument



Fisch
16,5 cm/6½"
Ø 0,4 mm **RU 7908-12/04**
Ø 0,6 mm **RU 7908-12/06**
Ø 0,8 mm **RU 7908-12/08**

Meßzylinder
Measuring cylinder

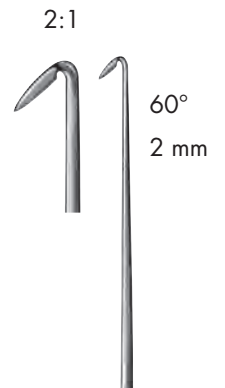

Plester
16 cm/6¼"
RU 7908-14/02

Schaber
Scraper



Plester
16 cm/6¼"
RU 7908-16/16

Führungsgabel
Wire guide



Hughes
16,5 cm/6½"
RU 7908-18/16

Steigbügelhäkchen
Stapes mobilizer

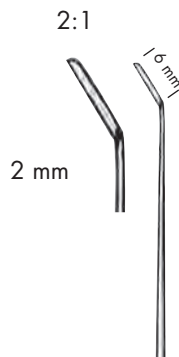

16 cm/6¼"
RU 7908-20/02

Transplantat-Träger/Raspatorium
Graft holder/raspatory



16 cm/6¼"
RU 7908-22/01

Dissektor links
Dissector left



16 cm/6¼"
RU 7908-22/02

Dissektor rechts
Dissector right

MIKROCHIRURGIE – DIVERSES INSTRUMENTARIUM
MICRO SURGERY – VARIOUS INSTRUMENTS



92 x 54 mm
RU 7908-24/01
Präpariertablett aus Metall
Preparation tray of metal



Regensburg
16 cm/6¼"
RU 7908-26/03
Spiegel/Mirrors



Höhmann
16 cm/6¼"
RU 7908-30/25



16 cm/6¼"
RU 7908-32/01
Elevatorium/Elevator



16 cm/6¼"
RU 7908-34/18
Raspatorium/Raspatory



Beales
16 cm/6¼"
RU 7908-38/16



Wullstein
16 cm/6¼"
RU 7908-40/32
Raspatorien/Raspatories

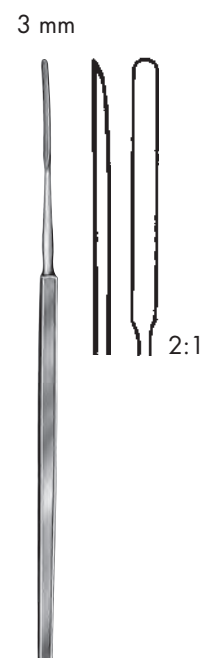

Lempert
16 cm/6¼"
RU 7908-42/30

MIKROCHIRURGIE – DIVERSES INSTRUMENTARIUM
MICRO SURGERY – VARIOUS INSTRUMENTS



16 cm/6¼"
Buckingham



RU 7909-01/01



RU 7909-01/03



RU 7909-08/00
17 cm/6¾"
Stapedektomie-Löffel
Stapedectomy curette



House
15 cm/6¼"
1,0/1,2 mm **RU 7909-10/10**
1,5/1,8 mm **RU 7909-10/15**



House
15 cm/6¼"
1,0/1,2 mm **RU 7909-11/10**
1,5/1,8 mm **RU 7909-11/15**

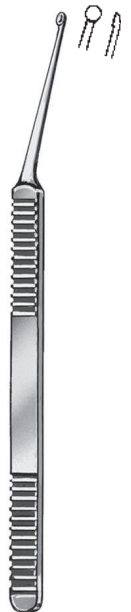

Shea
16 cm/6¼"
1,5 mm **RU 7909-12/15**

MIKROCHIRURGIE – DIVERSES INSTRUMENTARIUM
MICROSURGERY – VARIOUS INSTRUMENTS

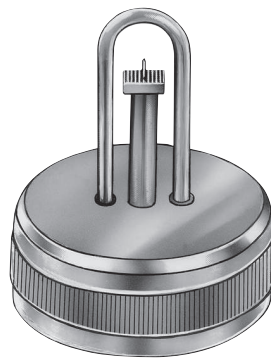

Schuknecht

RU 7909-30/00

Bieegerät zum Formen von
Stapes-Draht-Prothesen
*Wire bending die to pre-form
stainless steel wire*



Bei dieser Katalog-Auflage handelt es sich um einen Nachdruck mit geringfügigen Änderungen; daher entfällt der ursprüngliche Inhalt auf dieser Seite.

This catalogue edition is a reprint with minor amendments. This is why the initial content of this page has been removed.



Bei dieser Katalog-Auflage handelt es sich um einen Nachdruck mit geringfügigen Änderungen; daher entfällt der ursprüngliche Inhalt auf dieser Seite.

This catalogue edition is a reprint with minor amendments. This is why the initial content of this page has been removed.

KÜRETEN, LÖFFEL, SCHLINGEN
CURETTES, SPOONS, LOOPS



		Fig. 000	00	0	1	2	3	4	5
stumpf blunt		RU 7900-30	RU 7900-20	RU 7900-10	RU 7900-01	RU 7900-02	RU 7900-03	RU 7900-04	RU 7900-05
scharf sharp		RU 7902-30	RU 7902-20	RU 7902-10	RU 7902-01	RU 7902-02	RU 7902-03	RU 7902-04	RU 7902-05
stumpf blunt		RU 7903-30	RU 7903-20	RU 7903-10	RU 7903-01	RU 7903-02	RU 7903-03	RU 7903-04	RU 7903-05
scharf sharp		RU 7904-30	RU 7904-20	RU 7904-10	RU 7904-01	RU 7904-02	RU 7904-03	RU 7904-04	RU 7904-05

Buck

16,5 cm/6½"



Langenbeck
13 cm/5⅛"
RU 7915-13



Shapleigh
13 cm/5⅛"



RU 7916-01



RU 7916-02



Jansen
15 cm/6"
RU 7921-15



Barth
18 cm/7"
RU 7922-18



Billeau
16,5 cm/6½"



RU 7932-01



RU 7932-02



RU 7932-03



Snellen
16 cm/6¼"



RU 7933-00



RU 7933-01



RU 7933-02

KÜRETTEN, LÖFFEL, SCHLINGEN, HÄKCHEN
CURETTES, SPOONS, LOOPS, HOOKS



Gross
12 cm/4³/₄"
RU 7934-01



Formby
18 cm/7"
RU 7935-01



Musgrove
18 cm/7"
RU 7936-01



Bloch
11 cm/4"
RU 7938-11
Fadengabel



Zaufal
16 cm/6¹/₄"
RU 7939-16
Fremdkörperheber



Hartmann
16 cm/6¹/₄"
RU 7940-16



Lucae
14 cm/5¹/₂"
Knopfhäkchen



RU 7945-01



RU 7945-02



RU 7945-03



Wagener
14 cm/5¹/₂"
Knopfhäkchen



RU 7946-01



RU 7946-03



RU 7946-05



RU 7946-02



RU 7946-04



RU 7946-06



15,5 cm/6"
RU 7947-03



Day
16 cm/6¹/₄"
Ohrhäkchen



RU 7949-01



RU 7949-02



Zaufal-Jansen
15 cm/6"
RU 7950-01

**MESSER
KNIVES**



Politzer
16 cm/6¼"
RU 7960-16



Politzer
16 cm/6¼"
RU 7960-16/01



18 cm/7"
gerade
straight

- RU 7962-01** 1
- RU 7962-02** 2
- RU 7962-03** 3



17 cm/6¾"
gebogen
curved

- RU 7963-01** 1
- RU 7963-02** 2
- RU 7963-03** 3



Gerzog-Sexton
17 cm/6¾"
RU 7964-17



Politzer
16 cm/6½"
RU 7966-01



Lempert
15 cm/6"
RU 7967-15



Lempert
15 cm/6"



RU 7968-01



RU 7968-02



Lempert
15 cm/6"
RU 7968-15



Lempert
15 cm/6"
RU 7970-15

MYRINGOTOME, PARAZENTESENADELN, OHRBESTECK
MYRINGOTOMES, PARACENTESIS NEEDLES, EAR OPERATING SET



Politzer
16,5 cm/6½"
RU 7971-16
Parazentesenadel
Tympanum perforator



Agnew (Politzer)
17,5 cm/7"
RU 7972-17
Myringotom
Myringotome



Lucae
16 cm/6¼" **RU 7974-16**
Parazentesenadeln
Tympanum perforator



Lucae
18 cm/7" **RU 7974-18**
Parazentesenadel
Tympanum perforator



Politzer
17 cm/6¾"
RU 7976-01
Myringotom
Myringotome



16 cm/6¼"
RU 7978-01



16 cm/6¼"
Parazentesenadeln
Tympanum perforator



Sprague
19 cm/7½"
RU 7981-00
Ohrbesteck
Ear operating set

**PULVERBLÄSER, LUFTDUSCHE, HÖRSCHLAUCH
POWDER BLOWER, AIR DOUCHE, OTOSCOPE**

RU 7994-13
RU 7994-08
RU 7994-11



**Kabierske
RU 7994-01**

RU 7994-00 Pulverbläser, kpl. mit 3 Kanülen
(RU 7994-08 bis -13)
RU 7994-20 Ventilball
RU 7994-11 Kanüle für Nase
RU 7994-08 Kanüle für Rachen
RU 7994-13 Kanüle für Kehlkopf
RU 7994-01 Ersatz-Glasflasche
RU 7994-02 Deckel zu Pulverbläser

*Powder blower, complete
with 3 tips, RU 7994-08 – RU 7994-13*
Rubber bulb
Nasal tip
Aural tip
Larynx tip
Spare glass
Lid for powder blower

RU 7995-00 Politzer
Luftdusche, kpl. mit 3 Aufsätzen
*Air bag, complete
with 3 nasal tips*



**Gummibirne
Rubber bulb
RU 7995-50**



**Verbindungsstück
Connector
RU 7995-03**



**Aufsätze
Nasal tips**
RU 7995-15 15 mm Ø
RU 7995-17 17 mm Ø
RU 7995-22 22 mm Ø

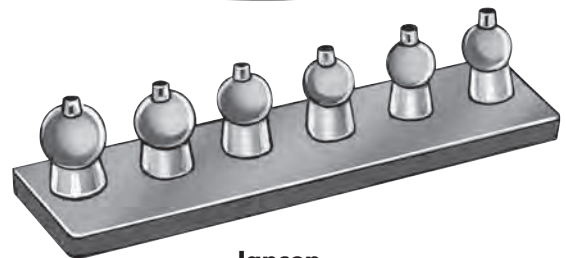

**Jansen
RU 7996-00**

**Hörschlauch, komplett mit einer schwarzen
Arztolive, 6 Patientenoliven (je 2 x # 1, 2, 3),
mit Ständer für Oliven**
*Diagnostic tube complete with one physician
ear piece, black, 6 patient ear pieces (2 each
1, 2, 3) with rack for ear pieces.*

OHRSPRITZE, NIERENSCHALE
EAR SYRINGE, KIDNEY BOWL



RU 7997-01



RU 7997-02



RU 7997-04

Ohrspritze, komplett mit 2 Kanülen und 1 Schutzteller
Ear syringe, complete with 2 cannulas and 1 protection shield

- 50 ml **RU 7997-05**
- 75 ml **RU 7997-07**
- 100 ml **RU 7997-10**

Nierenschale
Kidney bowl



250 x 140 x 40 mm
RU 8970-02

**OHRSPRITZE
EAR SYRINGE**



RU 7997-51 Spritze, 10 ml
Syringe, 10 ml



RU 7997-53 Plastikschlauch, 6 m
Plastic tube, 6 m

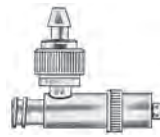

RU 7997-52 Ventilaufsatz
Valve attachment



RU 7997-54 Saugfuß
Metal sinker

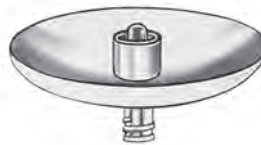

RU 7997-55 Schutzteller
Protection shield



RU 7997-56 Kanüle
cannula



RU 7997-57 Kanüle
cannula



RU 7997-58 Kanüle
cannula



RU 7997-59 Oliv-Aufsatz
cannula tip

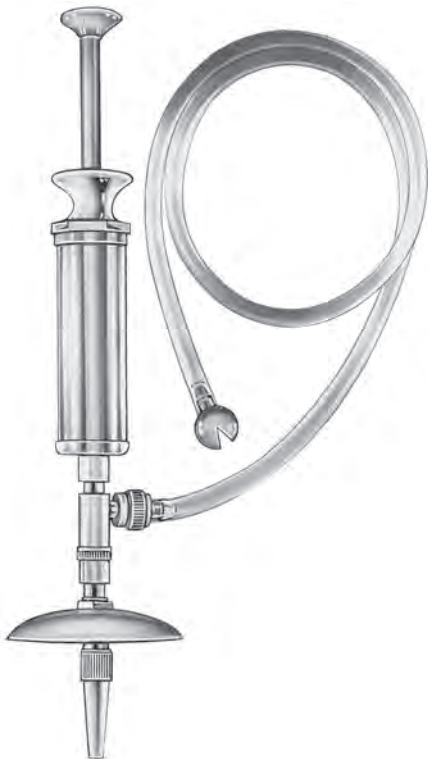

RU 7997-50
Ohrspritze, 10 ml, verchromt, komplett
Ear syringe, 10 ml, chromium-plated, complete

bestehend aus/consisting of:

- RU 7997-51**
- RU 7997-53**
- RU 7997-52**
- RU 7997-54**
- RU 7997-55**
- RU 7997-56**

RHINOLOGIE UND RHINOPLASTIK RHINOLOGY AND RHINOPLASTY

Seiten 243 - 318

Pages 243- 318

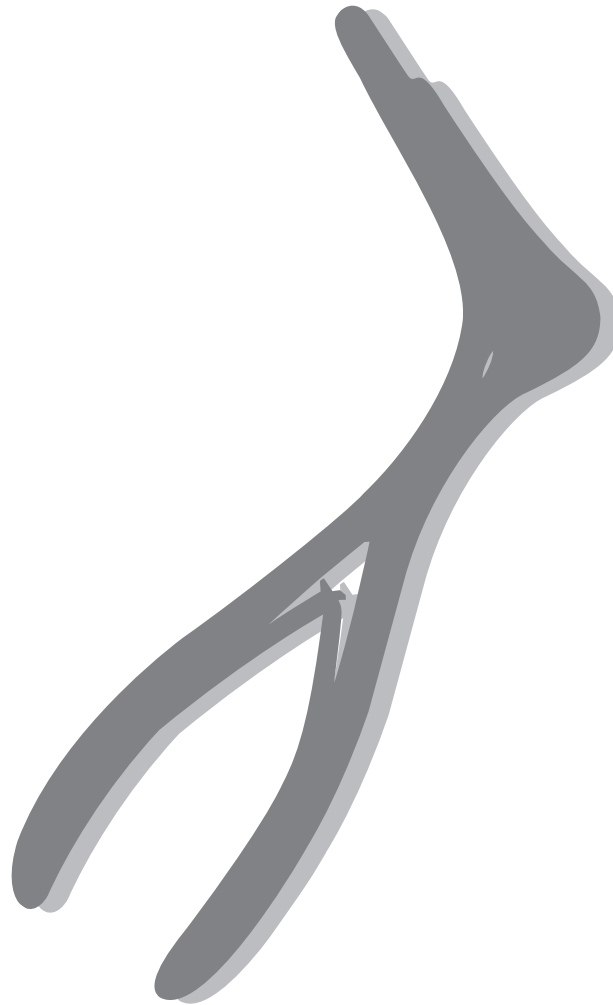

Übersicht

Scheren, Klemmen, Pinzetten
Spatel, Sonden, Stopfer, Watteträger
Prüf- und Messinstrumente
Nasenspekula, Zubehör
Polypenschnürer
Zerstäuber, Spiegel
Zangen, Septumscheren, Stanzen
Messer, Elevatorien, Raspatorien
Osteotome, Präparatoren, Meißel
Hämmer, Sägen, Raspeln
Knochen-Knorpelquetsche, Zubehör
Haken, Krallen, Fadengabeln

Overview

Scissors, sinus-, tissue forceps
Spatulas, probes, tampers, cotton applicators
Examination and measuring instruments
Nasal specula, accessories
Nasal snares
Atomizers, mirrors
Forceps, septum scissors, sphenoid forceps
Knives, elevators, raspatories
Osteotomes, dissectors, gouges, chisels
Mallets, saws, rasps
Bone crusher, accessories
Hooks, retractors, pusher, knottiers

Seiten / Pages

244-257, 276, 277
258-259
260
261-272
273
274-276
277-288, 317-318
288-290, 291-295, 316
296-302
302-308
308-309
309-316

**PRÄPARIERSCHEREN
DISSECTING SCISSORS**



Baby-Metzenbaum
gerade/straight 11,5 cm/4½"
RU 1280-11



gebogen/curved
RU 1281-11



Metzenbaum-Fino
14,5 cm/5¾"
gebogen/curved
RU 1291-14



Metzenbaum
14,5 cm/5½"
gerade/straight
RU 1301-14

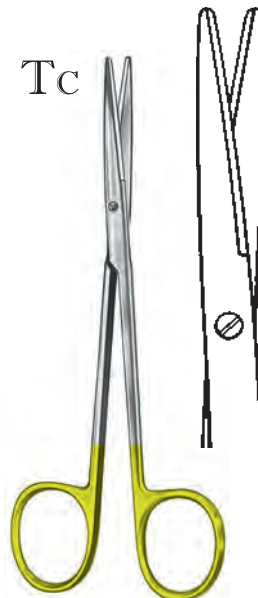

Metzenbaum
14,5 cm/5½"
RU 1304-14

PRÄPARIERSCHEREN
DISSECTING SCISSORS



Metzenbaum
14,5 cm/5½"
gebogen/curved
RU 1311-14



Metzenbaum
14,5 cm/5½"
gebogen/curved
RU 1314-14



Metzenbaum
18 cm/7"
gebogen/curved
RU 1331-18



Metzenbaum
18 cm/7"
gebogen/curved
RU 1334-18

FEINE SCHEREN
FINE SCISSORS

gerade
straight



Fig. 1
RU 1521-12



Fig. 2
RU 1522-12



Fig. 3
RU 1523-12



Wagner
12 cm/4¾"

gebogen
curved



Fig. 1
RU 1524-12



Fig. 2
RU 1525-12



Fig. 3
RU 1526-12

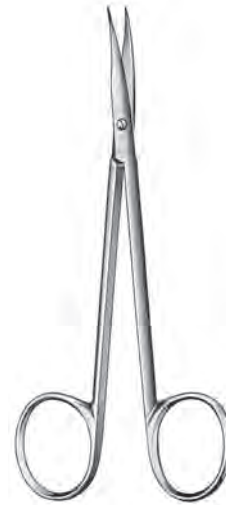

Jameson-Werber
13 cm/5"
gebogen/curved
RU 1584-13



Jameson-Werber
15 cm/6"
gebogen/curved
RU 1584-15



9 cm/3½"
RU 1636-09



Joseph
14 cm/5½"
gerade/straight
RU 1670-14



gebogen/curved
RU 1671-14



Kilner (Ragnell)
12 cm/4¾" **RU 1675-12**
13 cm/5" **RU 1675-13**
15 cm/6" **RU 1675-15**

NASENSCHEREN
NASAL SCISSORS



Heymann
18 cm/7"
RU 2115-18

SUPERCUT



Heymann
18 cm/7"
gezahnt/saw edge
RU 2115-18 MC



Heymann
19,5 cm/7¾"
RU 2116-19



Kirstein
17,5 cm/7"
gezahnt/saw edge
RU 2117-18

**NASENSCHEREN
NASAL SCISSORS**



Cottle-Masing
10,5 cm/4 1/8"
spitz/sharp stumpf/blunt
RU 2120-10 RU 2121-10



Kilner
13,5 cm/5 1/4"
RU 2124-11



Fomon
13 cm/5"
RU 2130-13



Fomon
13 cm/5"
gezahnt/serrated
RU 2130-13 MC



Fomon
13,5 cm/5 1/2"
schlank/gezahnt
delicate/serrated
RU 2131-13

SUPERCUT



Fomon
13 cm/5"
extra schlank/delicate
RU 2131-13 MC

**NASENSCHEREN
NASAL SCISSORS**



Fomon
13,5 cm/5¼"
RU 2132-13

SUPERCUT



Fomon
13 cm/5"
RU 2132-13 MC



Cottle
16 cm/6¼"
RU 2135-16



Cottle
16 cm/6¼"
gezahnt/serrated
RU 2135-16 MC

SUPERCUT



Halle
19 cm/7½"
RU 2140-19

Tc
RU 2136-16

FEINE SCHEREN
FINE SCISSORS



gerade/straight
11,5 cm/4½"
RU 2406-11

Tc



gebogen/curved
11,5 cm/4½"
RU 2407-11



Fino
gerade/straight
10,5 cm/4¼" **RU 2418-10**
11,5 cm/4½" **RU 2418-11**



Fino
gebogen/curved
RU 2419-10
RU 2419-11

FEINE SCHEREN
FINE SCISSORS



	gerade/straight	gebogen/curved	Fino gerade/straight	Fino gebogen/curved
9,5 cm/3¾"	RU 2420-09	RU 2421-09	RU 2422-09	RU 2423-09
10,5 cm/4¼"	RU 2420-10	RU 2421-10	RU 2422-10	RU 2423-10
11,5 cm/4½"	RU 2420-11	RU 2421-11	RU 2422-11	RU 2423-11



Stevens
10,5 cm/4¼"
11,5 cm/4½"
Sehnenscheren
Tenotomy scissors



gerade, spitz
straight, pointed

RU 2430-10
RU 2430-11



gebogen, spitz
curved, pointed

RU 2431-10
RU 2431-11



gerade, stumpf
straight, blunt

RU 2440-10
RU 2440-11



gebogen, stumpf
curved, blunt

RU 2441-10
RU 2441-11

FEINE SCHEREN
FINE SCISSORS



Graefe
10,5 cm/4¼"
RU 2455-10



11,5 cm/4½"
gerade/straight
RU 2460-11

gebogen/curved
RU 2461-11



gerade/straight
RU 2462-11

11,5 cm/4½"

Tc



gebogen/curved
RU 2463-11



Chadwick
11 cm/4½"
RU 2470-11



9,5 cm/3¾"
gerade/straight
RU 2476-02
gebogen/curved
RU 2476-03

ARTERIENKLEMMEN
ARTERY FORCEPS



14 cm/5½"

gerade/straight
RU 3068-14

gebogen/curved
RU 3069-14



Crile

14 cm/5½"



RU 3070-14

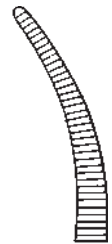

RU 3071-14



Providence

14 cm/5½"



RU 3090-14



RU 3091-14



Halsted-Mosquito

12 cm/4¾"



RU 3100-12



RU 3101-12



RU 3110-12



RU 3111-12

SINUSKLEMMEN
SINUS FORCEPS



Lister

12,5 cm/5"	RU 3810-12
16,0 cm/6"	RU 3810-16
18,0 cm/7"	RU 3810-18

ANATOMISCHE UND CHIRURGISCHE PINZETTEN
DRESSING AND TISSUE FORCEPS



Cottle
15 cm/6"
RU 4026-15



**Adson
Standard**



Adson

12 cm/4¾"	RU 4035-12	RU 4036-12
15 cm/6"	RU 4035-15	RU 4036-15



Micro-Adson



**Adson
Standard**

12 cm/4¾"	RU 4130-12	RU 4130-22	RU 4135-12
15 cm/6"	RU 4130-15	RU 4130-25	RU 4135-15

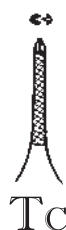

FEINE PINZETTEN, ATRAUMATISCHE PINZETTEN
FINE FORCEPS, ATRAUMATIC FORCEPS

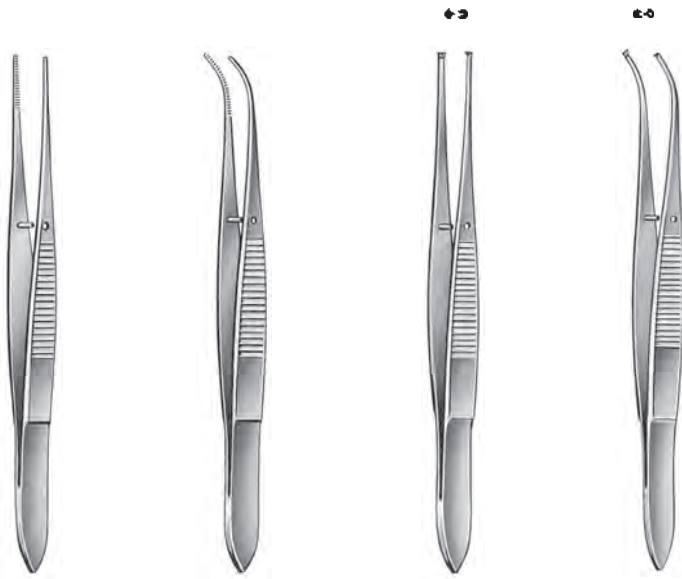

10,5 cm/4³/₄"

RU 4250-10

RU 4251-10

RU 4260-10

RU 4261-10



1,5 mm

De Bakey
16 cm/6¹/₄"
RU 7580-16



Adson-Atrauma
12 cm/4³/₄" **RU 7585-12**
15 cm/6" **RU 7585-15**

**NASENPINZETTEN, FASSPINZETTEN
NASAL FORCEPS, GRASPING FORCEPS**



Cottle
15 cm/6"
RU 7863-15



**Jansen
(Gruenwald)**



**Jansen
(Fine)**

16 cm/6¼"	RU 7864-16	RU 7864-26
18 cm/7"	RU 7864-18	RU 7864-28
20 cm/8"	RU 7864-20	RU 7864-30



Cottle
10 cm/4"
RU 8312-10



ohne Schloß
without spring
catch

RU 9942-11

mit Schloß
with spring
catch

RU 9943-11

Graefe
11 cm/4½"



Zahnbreite
Width of teeth
0,5 mm

Castroviejo
10 cm/4"
RU 9964-05

ÄTZSPATEL, NASENSONDEN, STOPFER
CAUSTIC SPATULA, NASAL-PROBES, TAMPER



Lange
18 cm/7"
RU 4919-01



Killian
16,5 cm/6½"
Ø 1,5 mm
RU 4927-01



13 cm/5"
Ø 1,5 mm
RU 4927-02



Siebenmann
18 cm/7"
RU 4928-18

WATTETRÄGER
COTTON APPLICATORS



Universal

	Ø 1,2 mm	Ø 1,5 mm	Ø 1,7 mm
12,5 cm 5"	RU 4930-12		RU 4932-12
16,0 cm 6¼"	RU 4930-16		RU 4932-16
18,0 cm 7"		RU 4931-18	RU 4932-18



spiralförmig
spiral threads

Frohn
Ø 1,0 mm

12 cm/4¾"	RU 4934-01
14 cm/5½"	RU 4934-02
16 cm/6¼"	RU 4934-03



Frohn
Ø 1,0 mm

12 cm/4¾"	RU 4934-11
14 cm/5½"	RU 4934-12
16 cm/6¼"	RU 4934-13

PRÜF- UND MESSINSTRUMENTE
EXAMINATION AND MEASURING INSTRUMENTS



graduiert mm/in
graduated mm/in
10 cm/4" **RU 5104-10**
15 cm/6" **RU 5104-15**
20 cm/8" **RU 5104-20**



Townley
10 cm/4"
RU 5114-10

**NASENSPEKULA
NASAL SPECULA**



RU 8000-01

RU 8000-02

RU 8000-03

Hartmann
15 cm/6"

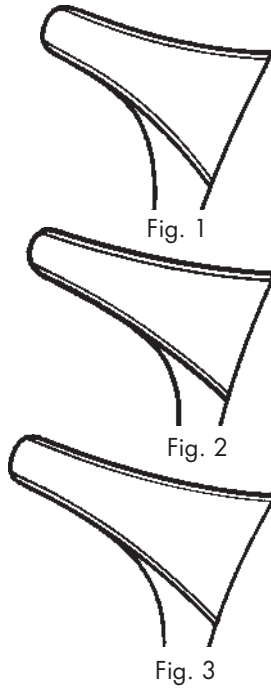

RU 8000-11

RU 8000-12

RU 8000-13



Hartmann
15 cm/6"



RU 8002-00

RU 8002-01

RU 8002-02

RU 8002-03

Hartmann-Halle
15 cm/6"

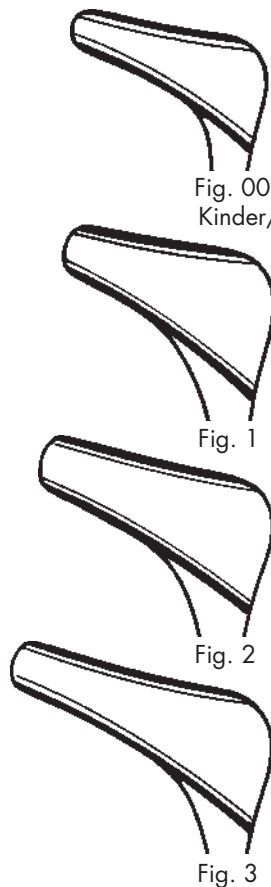

RU 8002-10

RU 8002-11

RU 8002-12

RU 8002-13



Hartmann-Halle
15 cm/6"

**NASENSPEKULA
NASAL SPECULA**



Tieck
13 cm/5"

RU 8004-01

Fig. 1



Säuglinge/
infants

RU 8004-02

Fig. 2



Kinder/
children

RU 8004-11



Tieck
13 cm/5"



Beckmann
15 cm/6"
13 cm/5"

Fig. 00
RU 8005-00

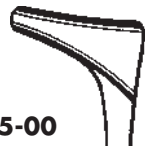

Säuglinge/
infants

Fig. 1
RU 8005-01

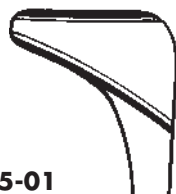

Fig. 2
RU 8005-02

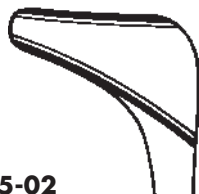
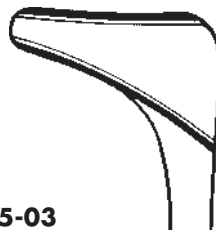
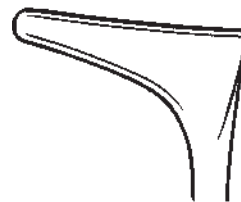

Fig. 3
RU 8005-03



Säuglinge/infants



Hartmann
14,5 cm/5¾"
leichtes Modell
light pattern
RU 8009-00

**NASENSPEKULA
NASAL SPECULA**



Mod. Wien
13 cm/5"

RU 8010-01

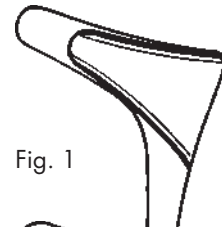

Fig. 1

RU 8010-02

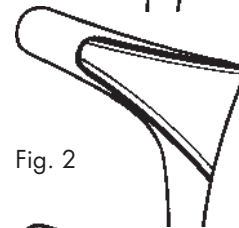

Fig. 2

RU 8010-03

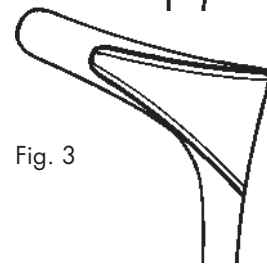

Fig. 3



Mod. Wien
13 cm/5"

RU 8011-11

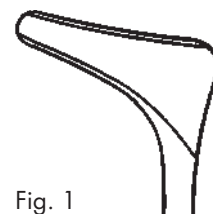

Fig. 1

RU 8011-12

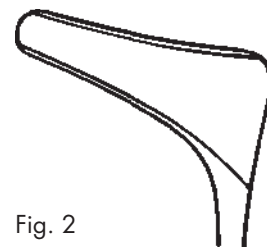

Fig. 2

**NASENSPEKULA
NASAL SPECULA**



Killian
14 cm/5½"

RU 8012-35

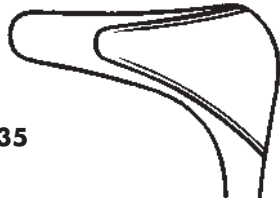

Fig. 1
40 mm

RU 8012-36

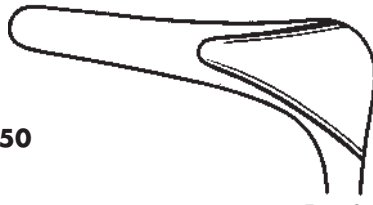

Fig. 2
55 mm

RU 8012-50

RU 8012-51

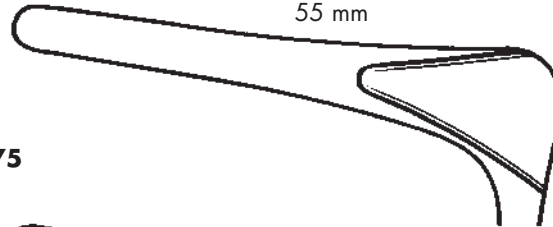

Fig. 3
75 mm

RU 8012-75

RU 8012-76



Killian
14 cm/5½"

RU 8012-90

RU 8012-91

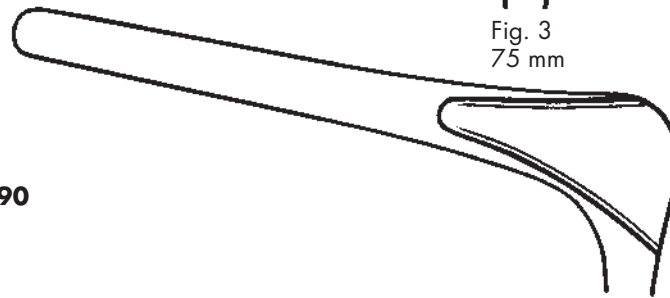
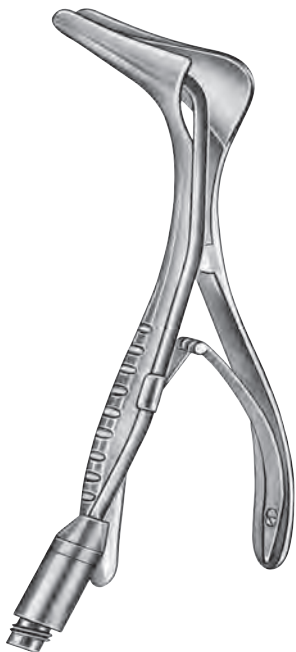

Fig. 4
90 mm



mit Kaltlichtträger
with fiber optic illumination
Fig. 1 40 mm **RU 8012-336**
Fig. 2 55 mm **RU 8012-351**
Fig. 3 75 mm **RU 8012-376**
Fig. 4 90 mm **RU 8012-391**
Kaltlichtträger, allein
Fiber optic illumination, only
RU 8012-95

Killian
14 cm/5½"

mit Absaugrohr/einhängbar
with suction tube
Fig. 2 55 mm
links/left **RU 8012-451**
rechts/right **RU 8012-551**
Absaugrohr, allein
Suction tube, only
links/left **RU 8012-98**
rechts/right **RU 8012-99**



NASENSPEKULA
NASAL SPECULA



Killian
14 cm/5½"
rechtes Blatt verkürzt
right blade shortened
RU 8012-83



Killian
14 cm/5½"
linkes Blatt verkürzt
left blade shortened
RU 8012-85

**NASENSPEKULA
NASAL SPECULA**



Killian-Struycken
14 cm/5½"

RU 8013-01

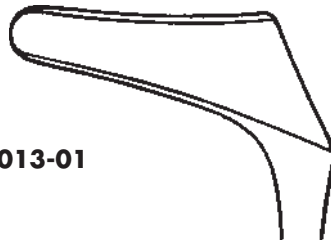

Fig. 1
40 mm

RU 8013-11

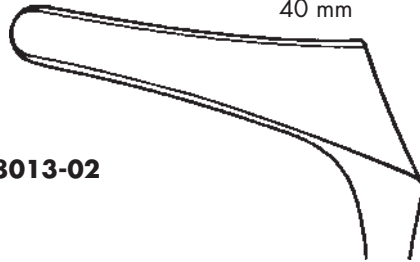

Fig. 2
55 mm

RU 8013-02

RU 8013-12

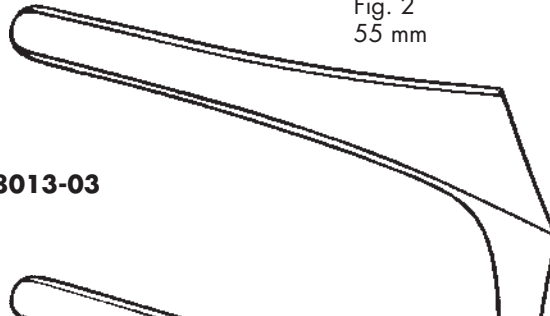

Fig. 3
75 mm

RU 8013-03

RU 8013-13

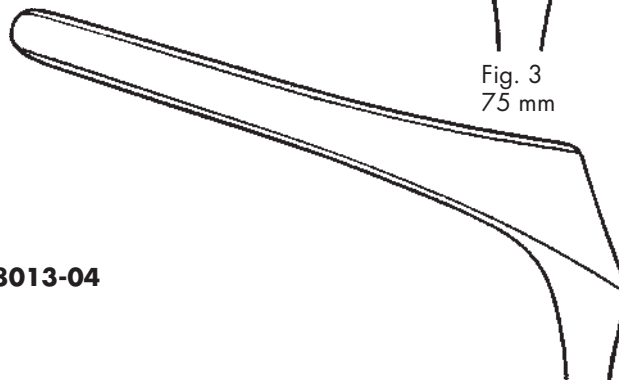
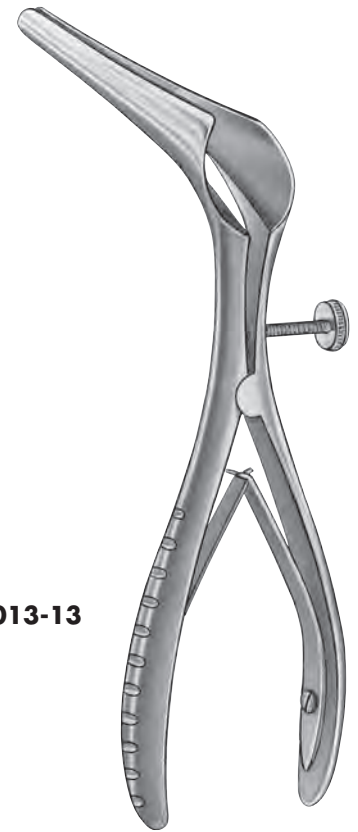

Fig. 4
90 mm

RU 8013-04

RU 8013-14



Killian-Struycken
14 cm/5½"

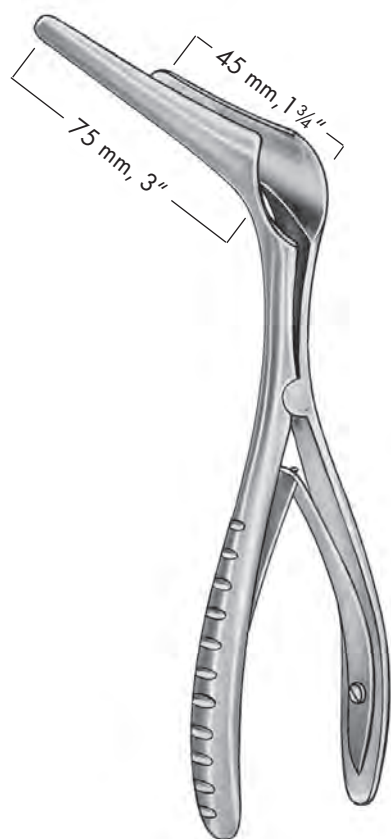

Killian-Struycken
14 cm/5½"
RU 8013-83
rechtes Blatt verkürzt
right blade shortened



Killian-Struycken
14 cm/5½"
RU 8013-85
linkes Blatt verkürzt
left blade shortened

NASENSPEKULA
NASAL SPECULA

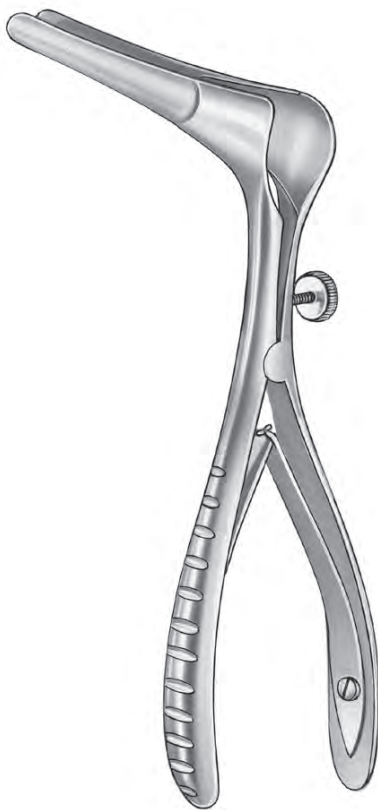

Killian-Walter
14 cm/5½"
dünnes Blatt/*thin blade*

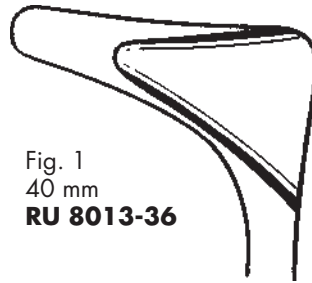

Fig. 1
40 mm
RU 8013-36

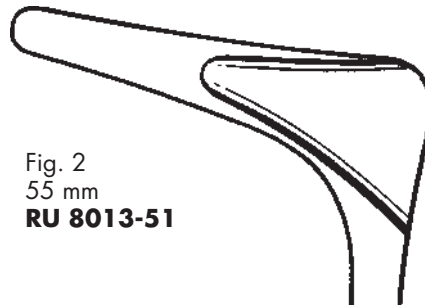

Fig. 2
55 mm
RU 8013-51

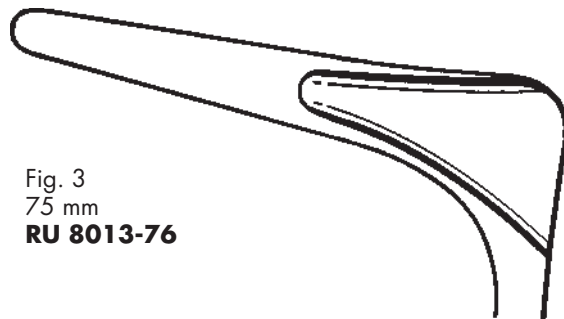

Fig. 3
75 mm
RU 8013-76

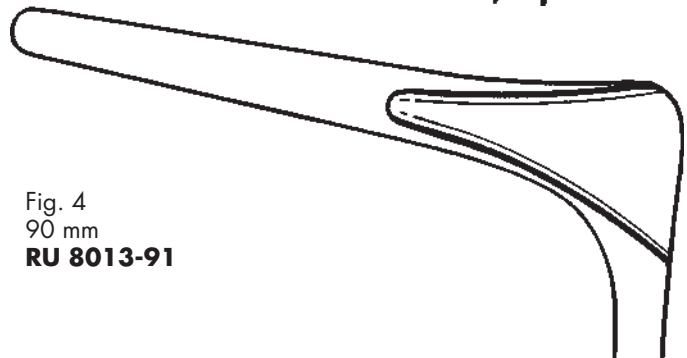

Fig. 4
90 mm
RU 8013-91

**NASENSPEKULA
NASAL SPECULA**



Cottle
15 cm/6"

- | | | |
|-------------------|--------|-------------------|
| RU 8014-36 | Fig. 1 | RU 8015-36 |
| RU 8014-51 | Fig. 2 | RU 8015-51 |
| RU 8014-76 | Fig. 3 | RU 8015-76 |
| RU 8014-91 | Fig. 4 | RU 8015-91 |

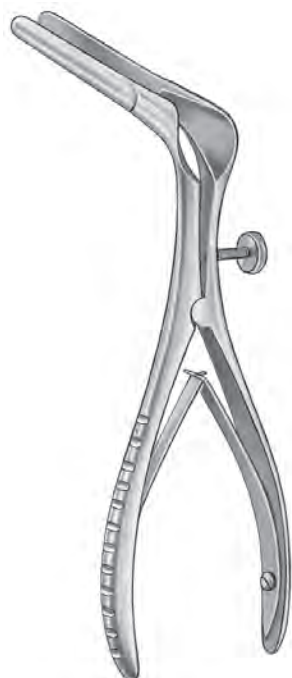
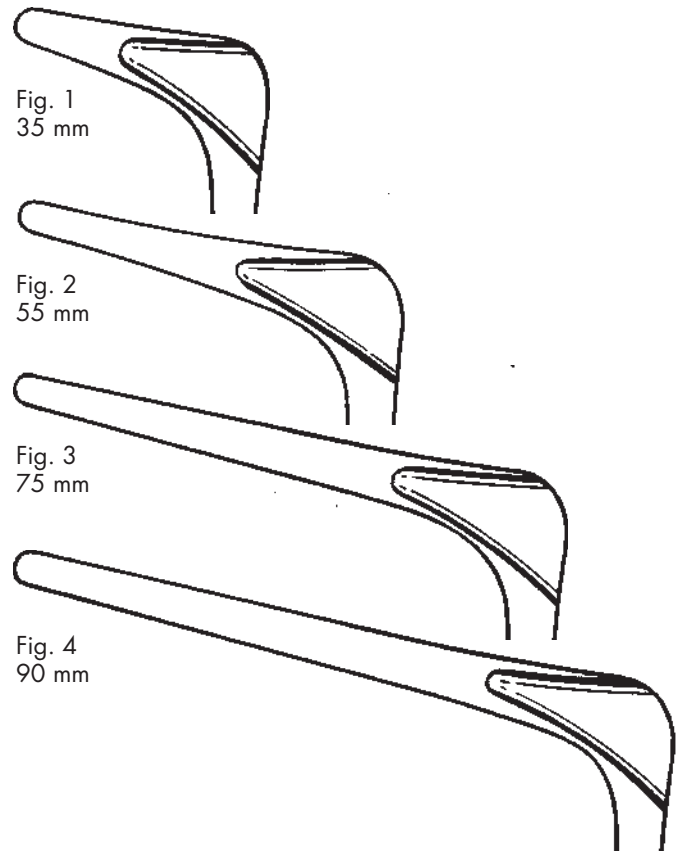

Cottle-Walter
13 cm/5"
extrem dünnes Blatt
very thin blade

RU 8016-36

RU 8016-46

RU 8016-51

RU 8016-76

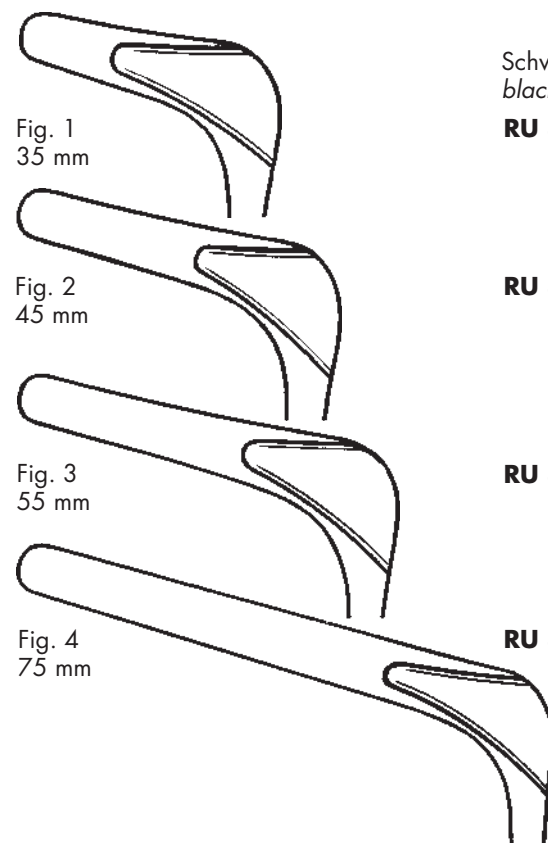

Schwarz
black finish

RU 8016-36B

RU 8016-46B

RU 8016-51B

RU 8016-76B

FLEXIBLER SPANNARM FÜR NASENSPEKULA
FLEXIBLE ARM FOR NASAL SPECULA



RU 6357-50

Flexibler Spannarm komplett, zur Befestigung an OP-Tischschienen
Flexible arm complete, for attachment to operating table

für/for

RU 8012-61	RU 8017-83
RU 8012-62	RU 8017-86
RU 8012-63	RU 8017-85
RU 8012-64	RU 8017-87

bestehend aus/consisting of:

RU 6357-10
RU 6357-53
RU 6357-54
RU 6357-55



RU 6357-10

flexibler Spannarm allein
Flexible arm only



RU 6357-53

Haltearm, auseinandernehmbar, zur Fixierung im Kugelgelenkkolben RU 6357-54 und zur wahlweisen Aufnahme der Kupplungsköpfe RU 6357-55
Holdering Rod, detachable, for fixation in ball and socket joint RU 6357-54 and to hold a desired coupling head RU 6357-55



RU 6357-54

Kugelgelenkkolben zum Befestigen an der OP-Tischschiene und zur Aufnahme des Haltearms RU 6357-53

Ball and Socket Joint for fixation of holding rod at the operating table RU 6357-53



RU 6357-55

Kupplungskopf, seitlich offen zur Aufnahme von 1 Spannarm RU 6357-10

Coupling head, lateral open, to hold 1 flexible arm RU 6357-10

NASENSPEKULA
NASAL SPECULA

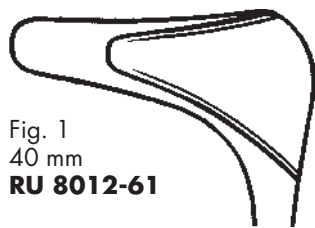

Fig. 1
40 mm
RU 8012-61

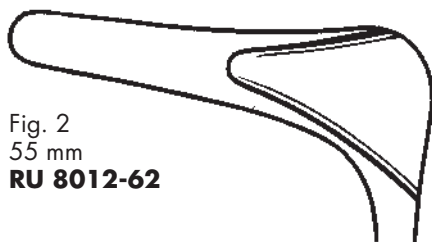

Fig. 2
55 mm
RU 8012-62

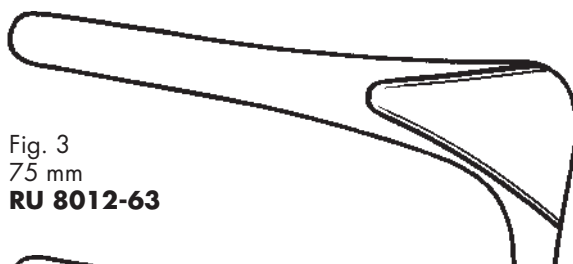

Fig. 3
75 mm
RU 8012-63

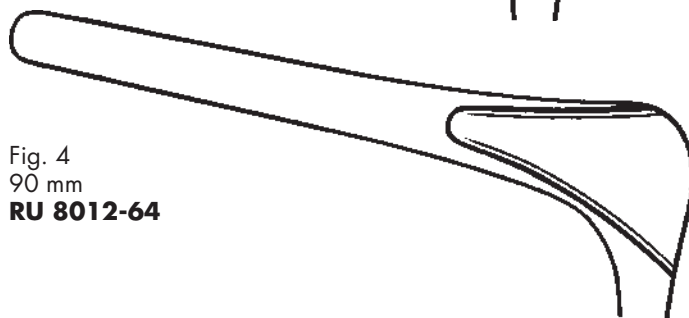

Fig. 4
90 mm
RU 8012-64



Killian
14 cm/5½"
für flexiblen Spannarm
for flexible arm

Daten zum flexiblen Spannarm entnehmen Sie bitte Seite 270
For flexible arm please refer to page 270

**NASENSPEKULA
NASAL SPECULA**



linkes Blatt verkürzt
mit Zähnen
*left blade shortened
with teeth*



rechtes Blatt verkürzt
mit Zähnen
*right blade shortened
with teeth*



rechtes Blatt/
right blade
55 mm
RU 8017-83



linkes Blatt/
left blade
55 mm
RU 8017-85

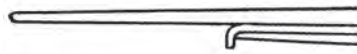

rechtes Blatt/
right blade
75 mm
RU 8017-86



linkes Blatt/
left blade
75 mm
RU 8017-87

Killian

14 cm/5½"

für flexiblen Spannarm Seite 270
for flexible arm on page 270



Thudichum
7 cm/2¾"



Bowman
7 cm/2¾"
RU 9012-07

Blattlänge <i>Length</i>	Standard <i>Standard</i>	Isoliert <i>Insulated</i>
12 mm	RU 8018-21	RU 8018-31
14 mm	RU 8018-22	RU 8018-32
16 mm	RU 8018-23	RU 8018-33
18 mm	RU 8018-24	RU 8018-34
20 mm	RU 8018-25	RU 8018-35
22 mm	RU 8018-26	RU 8018-36
24 mm	RU 8018-27	RU 8018-37
27 mm	RU 8018-27	RU 8018-38

**POLYPENSCHNÜRER
NASAL SNARES**



Krause
26 cm/10¼"
RU 8020-26

RU 8020-50
Rohraufsatz allein
Snare tube only

RU 8020-55
Drahtführer allein
Guide only

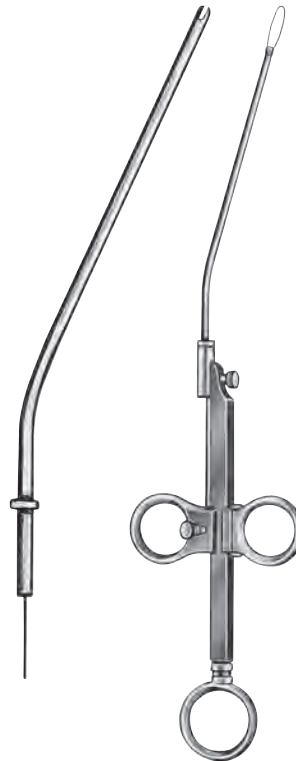

Krause-Voss
26 cm/10¼"
RU 8021-26

mit 2 Aufsätzen
with 2 snare tubes

RU 8021-50
Rohraufsatz vertikal
vertikal snare tube

RU 8021-55
Rohraufsatz horizontal
horizontal snare tube



Lange-Wilde
24 cm/9½"
RU 8022-24

**Schnürerdraht
Snare wire**

10 m/33ft.



Ø 0,3 mm **RU 7856-03**
Ø 0,4 mm **RU 7856-04**



Packung à 12 Stück
package of 1 dozen each

Ø 0,3 mm **RU 8024-10**
Ø 0,35 mm **RU 8024-11**

Packung à 100 Stück
package of 100 pieces

Ø 0,3 mm **RU 8024-10/00**
Ø 0,35 mm **RU 8024-11/00**

**ZERSTÄUBER
ATOMIZERS**

Verchromte Zerstäuber, inkl. 12 ml Flakon
Chromium-plated atomizers, incl. 12 ml glass bottle



RU 8025-01
für die Nase, gerade
for nose, straight

RU 8025-12
Ersatzflakon 12 ml, alleine
spare glass bottle, 12 ml, only



RU 8025-02
für Nasen- und Rachenraum, aufwärts gebogen
for nasopharynx, curved upwards



RU 8025-03
für Kehlkopf, abwärts gebogen
for larynx, curved downwards

**ZERSTÄUBER
ATOMIZERS**



Universal-Zerstäuber mit einstellbarer Spitze,
Messing verchromt, bestehend aus:

*Universal atomiser with adjustable nozzle,
chrom-plated brass, consisting of:*

RU 8026-00

- 1 Nasenolive für Zerstäuber, Messing verchromt (RU 8026-10)
- 1 Glasflasche 30 ml, Ø 33 mm, 80 mm (Höhe),
Gewinde GL18 (RU 8026-36)
- 1 Gebläseball mit Schlauch und Ventil,
Ø 49 mm, Länge 25 cm/10" (RU 8028-10)

- 1 Nasal tip for atomiser, chrom-plated brass (RU 8026-10)
- 1 Glass bottle 30 ml, Ø 33 mm, 80 mm (height),
thread GL18 (RU 8026-36)
- 1 Inflation bulb with tube and valve, Ø 49 mm, length 25 cm/10"
(RU 8028-10)



Universal-Kokainzerstäuber mit einstellbarer Spitze,
bestehend aus:

*Universal cocaine atomiser with adjustable nozzle,
consisting of:*

RU 8027-00

- 1 Glasflakon 6 ml, Ø 14 mm, 73 mm (Länge),
Gewinde 17 x 28 Gg, Edelstahl (RU 8027-06)
- 1 Metallfuß für Glasflakon Ø 14 mm, Edelstahl (RU 8027-10)
- 1 Gebläseball mit Schlauch und Ventil,
Ø 49 mm, Länge 25 cm/10" (RU 8028-10)

- 1 Glass flacon 6 ml, Ø 14 mm, 73 mm (length),
thread 17 x 28 Gg, stainless steel (RU 8027-06)
- 1 Metal stand for glass flacon Ø 14 mm, stainless steel (RU 8027-10)
- 1 Inflation bulb with tube and valve, Ø 49 mm, length 25 cm/10"
(RU 8028-10)

RU 8027-06 Ersatzflakon 6 ml, alleine
Spare glass bottle 6 ml, only

RU 8027-10 Metallfuß, alleine
Metal stand, only



Gebläseball mit Schlauch und Ventil,
Ø 49 mm, Länge 25 cm/10"

*Inflation bulb with tube and valve,
Ø 49 mm, length 25 cm/10"*

RU 8028-10

NASENSPIEGEL, SINUSKLEMMEN, NASENPINZETTEN
NASAL MIRROR, SINUS FORCEPS, NASAL FORCEPS

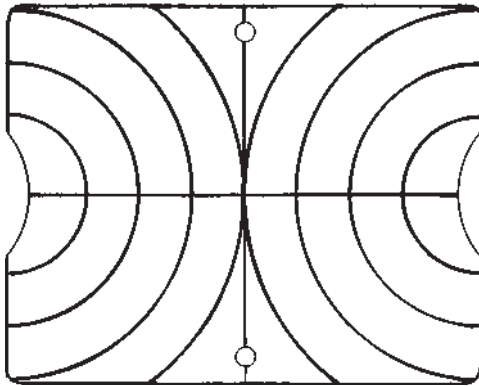

Glatzel
200 x 130 mm/8" x 5"
RU 8029-01



Lister
16 cm/6¼"
RU 3810-16
Sinusklemme
Sinus forceps



Troeltsch
(Wilde)

11 cm/4 ³ / ₈ "	RU 7860-11
12 cm/4 ³ / ₄ "	RU 7860-12
15 cm/6"	RU 7860-15
18 cm/7"	RU 7860-18

2,2 mm



Jansen
(Gruenwald)

1 mm



Jansen
(Fine)



Jansen

16 cm/6¼"	RU 7864-16	RU 7864-26	RU 7865-16
18 cm/7"	RU 7864-18	RU 7864-28	
20 cm/8"	RU 7864-20	RU 7864-30	RU 7865-20

**NASENTAMPONZANGEN, SEPTUMZANGEN
NASAL DRESSING FORCEPS, SEPTUM FORCEPS**



Tilley
16 cm/6¼"
RU 8033-16



Westmacott (West)
20 cm/8"
RU 8036-20

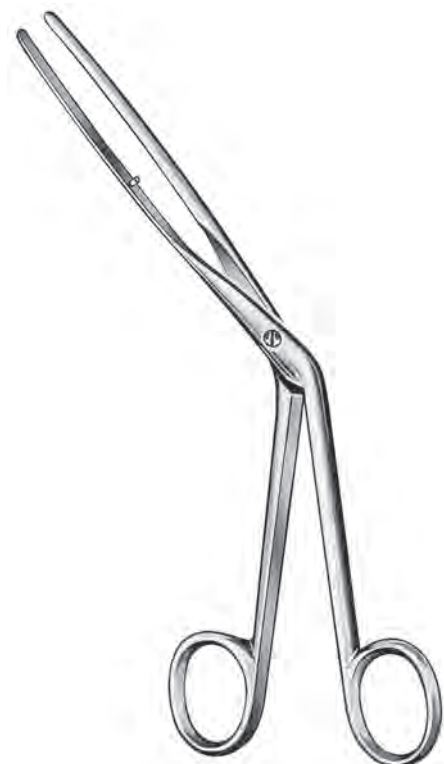

Lubet-Barbon
20 cm/8"
RU 8037-20



Hartmann
16 cm/6¼"
RU 8050-16



Hartmann
20 cm/8"
RU 8050-20

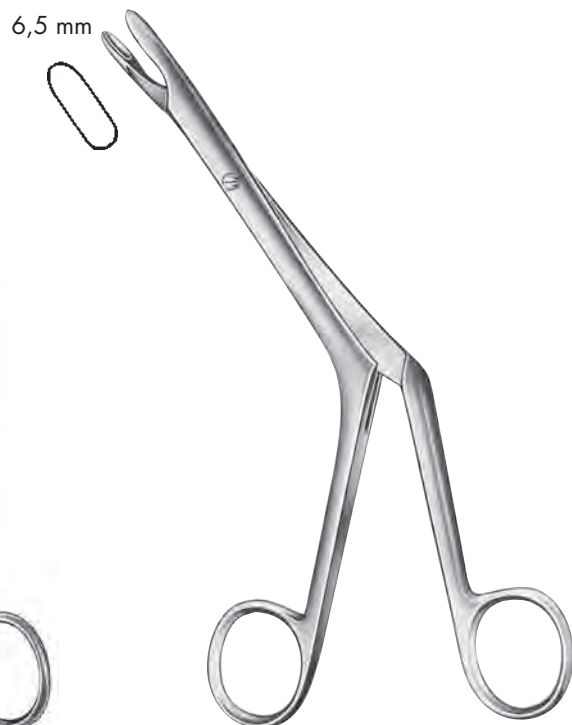

Heymann-Knight
19 cm/7½"
RU 8059-19

POLYPENZANGEN, SEPTUMZANGEN
POLYPUS FORCEPS, SEPTUM FORCEPS



Craig
17,5 cm/7"
RU 8065-18

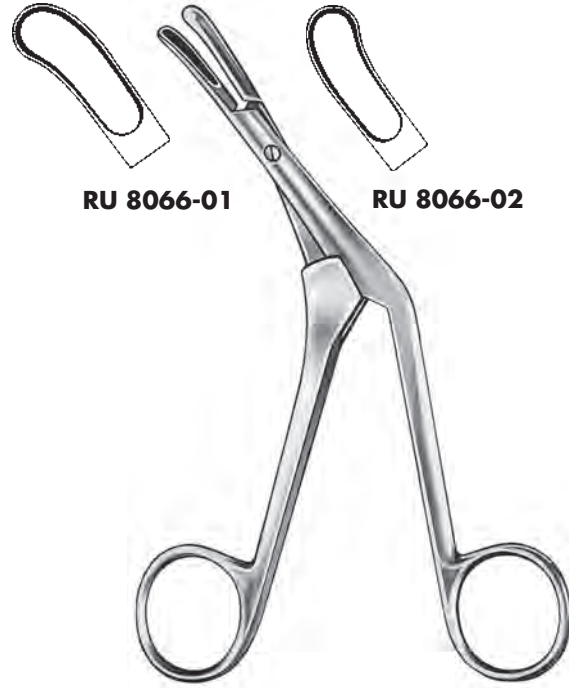

Craig-Domnick
17,5 cm/7"

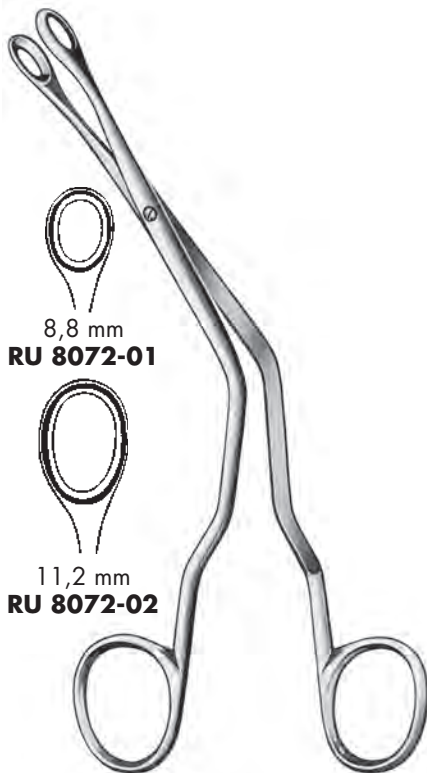

Luc
20 cm/8"

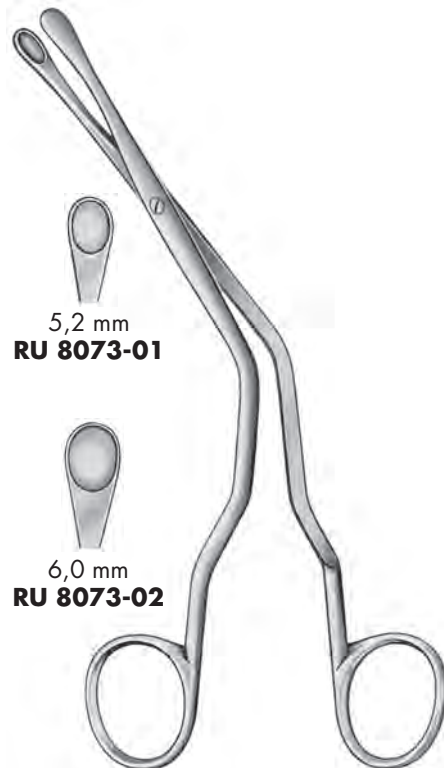

Luc
20 cm/8"

**SEPTUMZANGEN, LÖFFELZÄNGCHEN
SEPTUM FORCEPS, CUP-SHAPED FORCEPS**

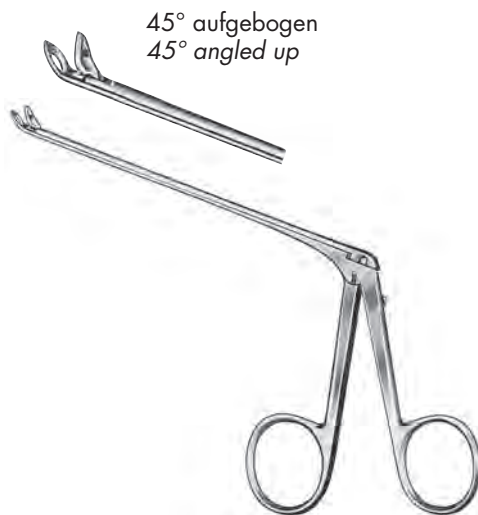

Strümpel-Voss
11 cm
RU 7884-11



Strümpel
8,5 cm/3³/₄" **RU 7884-09**
10 cm/4" **RU 7884-10**

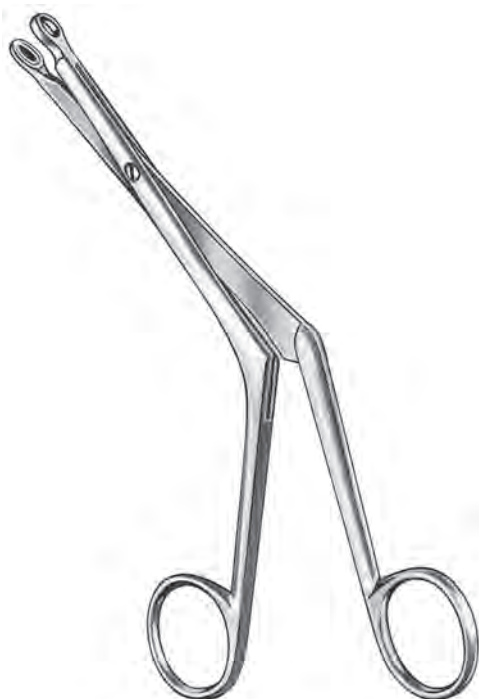

Bruenings
19 cm/7¹/₂"



Ø 3 mm
RU 8079-01

**SIEBBEINZANGEN
ETHMOIDAL FORCEPS**





Maul jaw mm	Schaftlänge length of shaft 12 cm/4¾"	Schaftlänge length of shaft 17 cm/6¾"
3 x 10	RU 8080-00	RU 8080-10
2 x 10	RU 8080-02	RU 8080-12
2,5 x 8	RU 8080-03	
PROCLEAN* 3 x 10	RU 8080-00P	



Maul jaw mm	Schaftlänge length of shaft 12 cm/4¾"
3 x 10	RU 8081-00
PROCLEAN* 3 x 10	RU 8081-00P



Takahashi

- 3 mm  **RU 8082-01**
- 3,6 mm  **RU 8082-02**
- 4,2 mm  **RU 8082-03**

-  **RU 8083-01**
- 3 mm  **RU 8083-01**



Watson-Williams

**SEPTUMZANGEN, BIOPSIE- UND FASSZANGEN
SEPTUM FORCEPS, BIOPSY AND GRASPING FORCEPS**

6 mm
RU 8085-01

8 mm
RU 8085-02

10 mm
RU 8085-03

6,5 mm
RU 8086-00

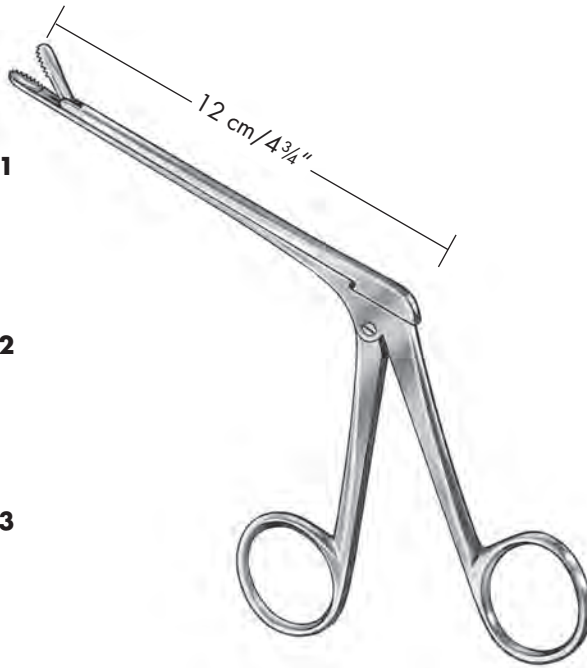

Watson-Williams
19 cm / 7 1/2"



Ferris-Smith
RU 8087-00

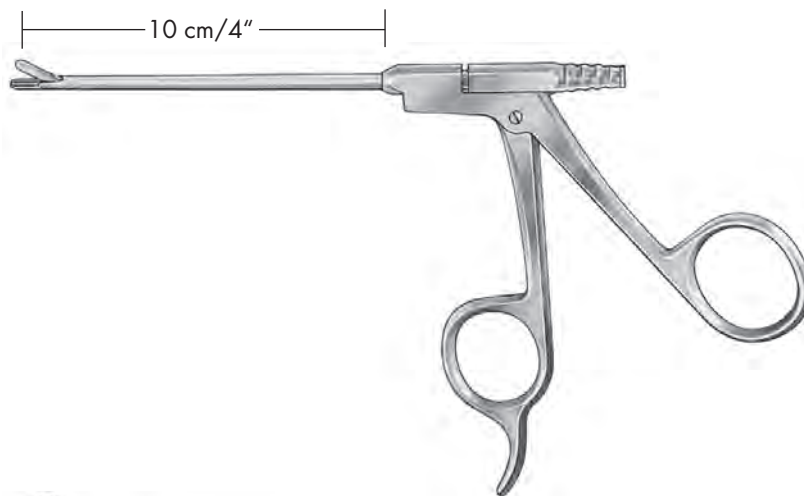

8,5 x 4,0 mm



RU 8089-00 *gerade, straight*

8,5 x 4,0 mm











RU 8089-01 *30° aufgewinkelt, 30° angled up*

Biopsie- und Faßzange mit Absaugkanal
Biopsy and grasping forceps with suction tube

**SIEBBEINZANGEN
ETHMOIDAL FORCEPS**

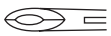









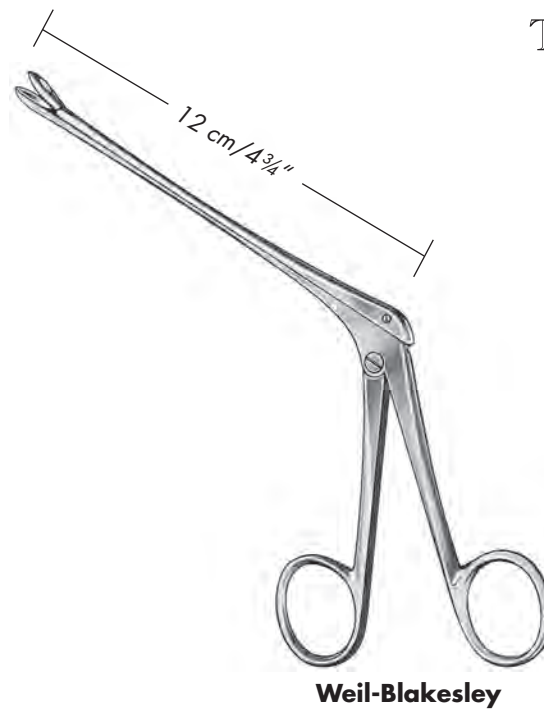

Weil-Blakesley

		 gerade/ <i>straight</i>	 45° aufwärts gebogen 45° angled up	 90° aufwärts gebogen 90° angled up
2,5 mm		RU 8090-00 RU 8090-00P*	RU 8091-00 RU 8091-00P*	RU 8092-00
3,0 mm		RU 8090-01 RU 8090-01P*	RU 8091-01 RU 8091-01P*	RU 8092-01
3,5 mm		RU 8090-02 RU 8090-02P*	RU 8091-02 RU 8091-02P*	RU 8092-02
4,5 mm		RU 8090-03 RU 8090-03P*	RU 8091-03 RU 8091-03P*	RU 8092-03
5,0 mm		RU 8090-04 RU 8090-04P*	RU 8091-04	RU 8092-04
6,0 mm		RU 8090-05 RU 8090-05P*	RU 8091-05	RU 8092-05

* = PROCLEAN*

**SIEBBEINZANGEN
ETHMOIDAL FORCEPS**



		gerade/straight			45° aufwärts gebogen 45° angled up			90° aufwärts gebogen 90° angled up	
		TITAN	TITAN CERAMED®		TITAN	TITAN CERAMED®		TITAN	TITAN CERAMED®
2,5mm 	RU 8090-00 TI	RU 8090-00 TI/CR	RU 8091-00 TI	RU 8091-00 TI/CR	RU 8092-00 TI	RU 8092-00 TI/CR			
3,0 mm 	RU 8090-01 TI	RU 8090-01 TI/CR	RU 8091-01 TI	RU 8091-01 TI/CR	RU 8092-01 TI	RU 8092-01 TI/CR			
3,5 mm 	RU 8090-02 TI	RU 8090-02 TI/CR	RU 8091-02 TI	RU 8091-02 TI/CR	RU 8092-02 TI	RU 8092-02 TI/CR			
4,2 mm 	RU 8090-03 TI	RU 8090-03 TI/CR	RU 8091-03 TI	RU 8091-03 TI/CR	RU 8092-03 TI	RU 8092-03 TI/CR			
5,0 mm 	RU 8090-04 TI	RU 8090-04 TI/CR	RU 8091-04 TI	RU 8091-04 TI/CR	RU 8092-04 TI	RU 8092-04 TI/CR			
6,0 mm 	RU 8090-05 TI	RU 8090-05 TI/CR	RU 8091-05 TI	RU 8091-05 TI/CR	RU 8092-05 TI	RU 8092-05 TI/CR			

**SIEBBEINZANGEN
ETHMOIDAL FORCEPS**

**Neu entwickelte Blakesley Siebbeinzangen mit verbessertem, modifiziertem, durchschneidendem Maul.
New developed Blakesley ethmoid forceps with improved, modified, intersecting jaw.**

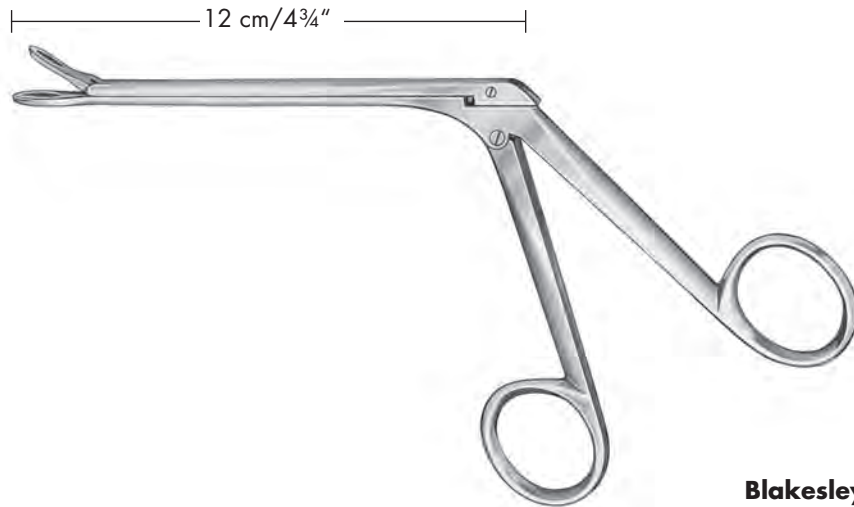

Blakesley-Rudolf



Größe Size	Maul gerade straight jaw	Maul aufgewinkelt jaw angled up	Maul nach links schneidend left cutting	Maul nach rechts schneidend right cutting
Fig. 0/2,5 mm	RU 8090-20	RU 8091-20		
Fig. 2/3,5 mm	RU 8090-22	RU 8091-22	RU 8090-22L	RU 8090-22R
Fig. 4/4,8 mm	RU 8090-24	RU 8091-24		

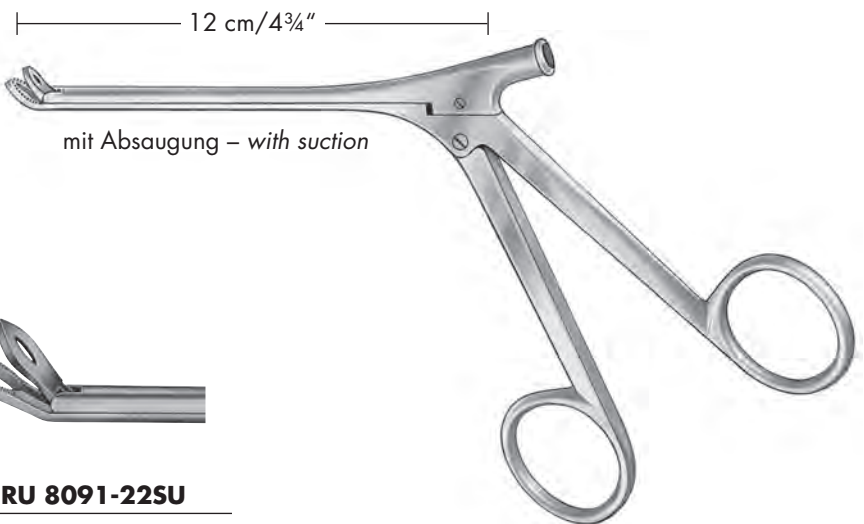

mit Absaugung – with suction



Mit Absaugung/with suction

Fig. 2/3,5 mm **RU 8090-22SU** **RU 8091-22SU**

**CONCHOTOME
NASAL CUTTING FORCEPS**



Struycken

RU 8094-00
1,0 x 19 mm

RU 8094-00/01
1,2 x 19 mm



Hajek

RU 8095-00



Myles

RU 8100-01
2,0 x 10 mm

RU 8100-02
2,5 x 12 mm

RU 8100-03
3,0 x 14 mm

RU 8100-04
3,5 x 15 mm



Hajek

RU 8102-01
3,0 x 12 mm

RU 8102-02
3,5 x 14 mm

RU 8102-03
4,0 x 16 mm



Grünwald-Henke

RU 8103-21
2,5 x 11 mm

RU 8103-22
3,0 x 11 mm



Hartmann

RU 8108-05
5 mm

RU 8108-07
7 mm

RU 8108-09
9 mm

RU 8108-11
11 mm



Hartmann

RU 8108-15
5 mm

RU 8108-17
7 mm

RU 8108-19
9 mm

RU 8108-21
11 mm



Schmeden

RU 8109-01
5 mm

RU 8110-01
8 mm

RU 8110-02
10 mm

SEPTUMZANGEN, SEPTUMSCHEREN
SEPTUM FORCEPS, SEPTUM SCISSORS



Middleton-Jansen
19 cm/7½"
RU 8121-19



Middleton-Jansen
19 cm/7½"
RU 8122-19





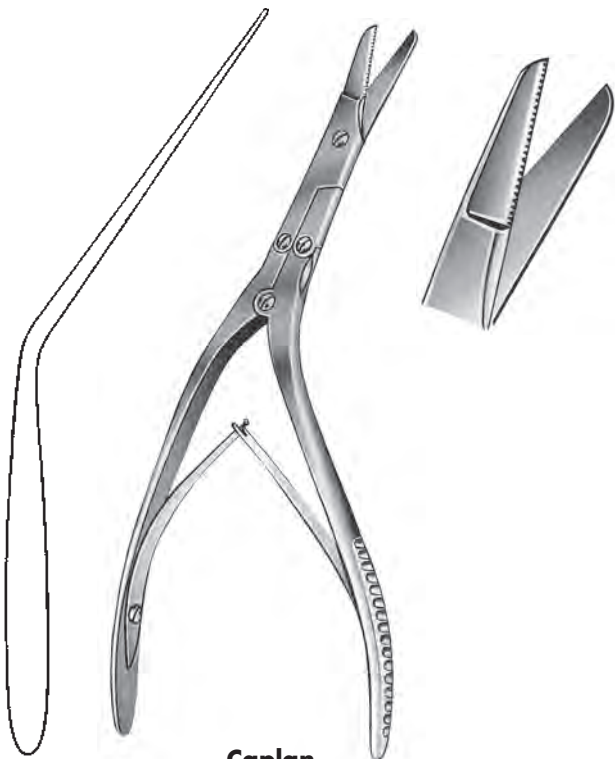

Kazanjian
18 cm/7"
RU 8125-18



Caplan
20 cm/8"
RU 8126-20





**KEILBEINSTANZEN
SPHENOIDAL PUNCHES**



-  **RU 8130-01**
4 mm
-  **RU 8130-02**
4 mm
-  **RU 8130-03**
3,5 mm
-  **RU 8130-04**
3,5 mm



Bissbreite
Width of bite

-  3 mm **RU 8134-03**
-  4 mm **RU 8134-04**
-  5 mm **RU 8134-05**
-  6 mm **RU 8134-06**

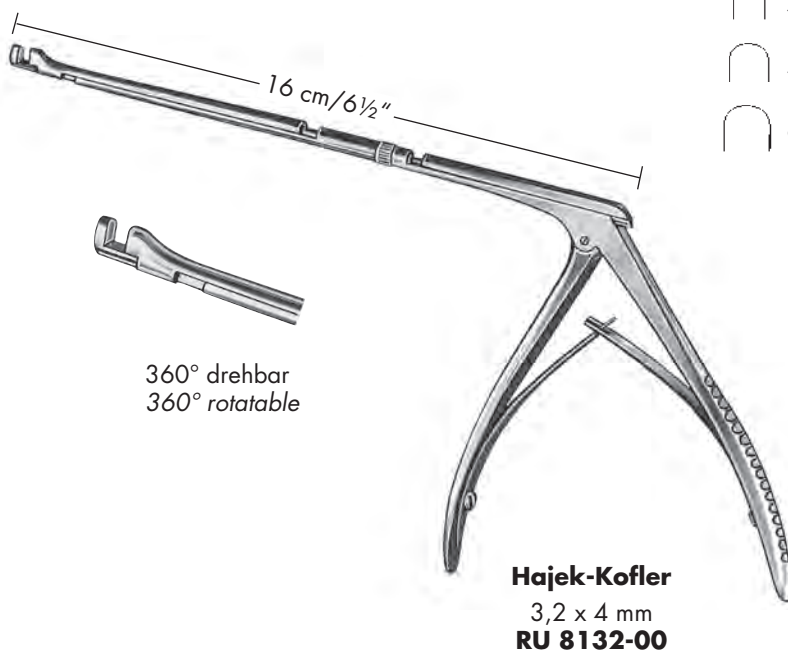

**SCHARFE NASENZANGEN, NASENPLASTIKMESSER
ADENOID CUTTING FORCEPS, RHINOPLASTIC AND NASAL KNIVES**



Jurasz
22 cm/8¾"



RU 8139-01



RU 8139-02



RU 8139-03



gebogen/curved
RU 8141-01

Joseph
15 cm/6"
spitz/sharp
gerade/straight
RU 8140-01



gebogen/curved
RU 8143-01

Joseph
15 cm/6"
stumpf/blunt
gerade/straight
RU 8142-01



Converse
15 cm/6"
RU 8144-15



Joseph
14 cm/5½"
RU 8145-15

**NASENPLASTIKMESSER, RITZMESSER
RHINOPLASTIC AND NASAL KNIVES**



Cottle
15 cm/6"
RU 8146-15



Cottle
14 cm/5½"
RU 8147-14



Freer
16 cm/6¼"
RU 8149-02



Joseph
16,5 cm/6½"
RU 8152-16



Maltz
16,5 cm/6½"
RU 8153-16



Fomon
15 cm/6"
RU 8154-15



Masing
13,5 cm/5¼"
RU 8155-13



Masing
14 cm/5½"
RU 8156-14



Freer
19 cm/7½"
RU 8171-19

SEPTUMMESSER
SEPTUM KNIVES



Ballenger
20 cm/8"

RU 8200-03
RU 8200-04
RU 8200-05



3 mm
4 mm
5 mm

RU 8201-03
RU 8201-04
RU 8201-05



Ballenger
20 cm/8"



Bruenings
16,5 cm/6½"
RU 8202-16

SEPTUM-ELEVATORIEN
SEPTUM ELEVATORS



3 mm **RU-8203-03**
4 mm **RU-8203-04**
5 mm **RU-8203-05**

Mc Kenty
15 cm/6"



Halle
18,5 cm/7¼"
stumpf/blunt
RU 8204-16



Joseph
16,5 cm/6½"
RU 8206-16



Killian
18 cm/7"
RU 8209-18



Cottle
19,5 cm/7½"
RU 8210-19



Freer-Joseph
20 cm/7¾"
RU 8211-20

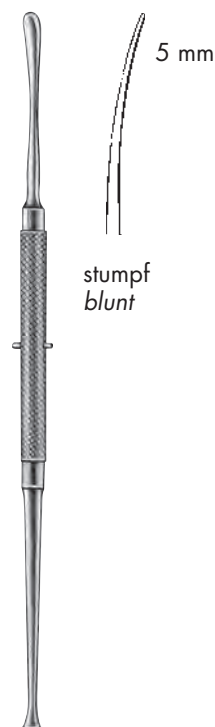

Freer
19 cm/7½"
RU 8212-19

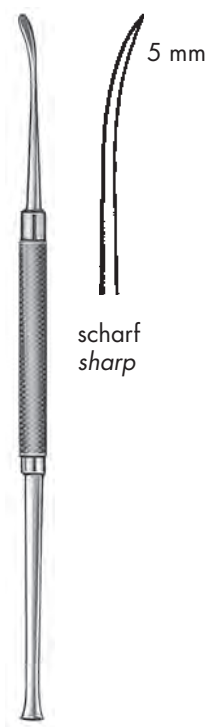

Freer
19 cm/7½"
RU 8213-19

SEPTUM-ELEVATORIEN
SEPTUM ELEVATORS



Freer-USA Mod.
20 cm/8¾"
RU 8214-20

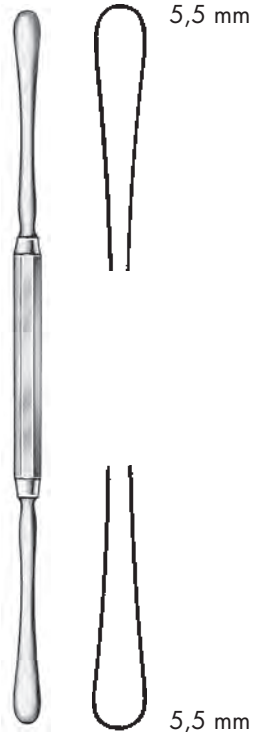

Hajek-Ballenger
19 cm/7½"
RU 8215-20

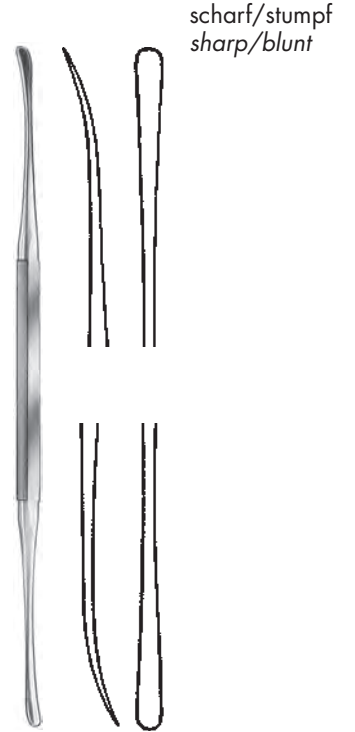

Freer
18 cm/7"
RU 8216-18



Freer-Yasargil
18,5 cm/7¼"
scharf/sharp
RU 8217-18



Howarth
21,5 cm/8½"
RU 8218-21



Mc Kenty
22 cm/8¾"
RU 8219-22

SEPTUM-ELEVATORIEN
SEPTUM ELEVATORS



Freer
18,5 cm/7¼"
RU 8220-19



Freer
17,5 cm/7"
RU 8221-17



Killian
18,5 cm/7¼" **RU 8222-18**
22 cm/8¾" **RU 8226-22**

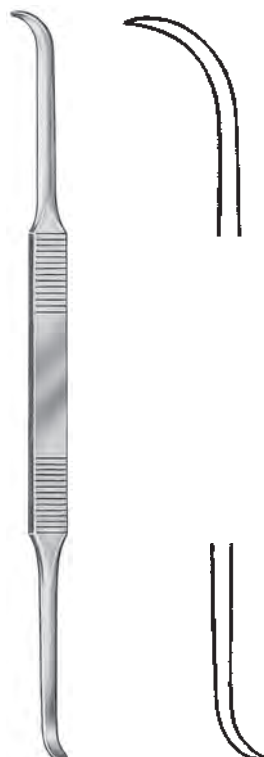

Cottle
23 cm/9"
RU 8224-23



Killian
18,5 cm/7¼"
scharf/stumpf, sharp/blunt
RU 8226-18

**RASPATORIEN, ELEVATORIEN
RASPATORIES, ELEVATORS**



Pierce
21 cm/8¼"
RU 8228-21



Pennington
21 cm/8¼"
RU 8230-21

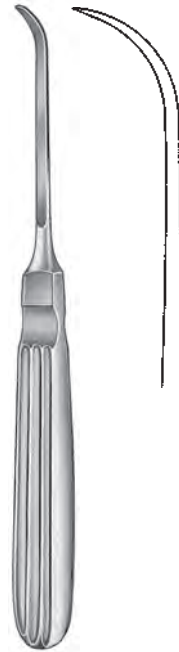

17 cm/6¾"

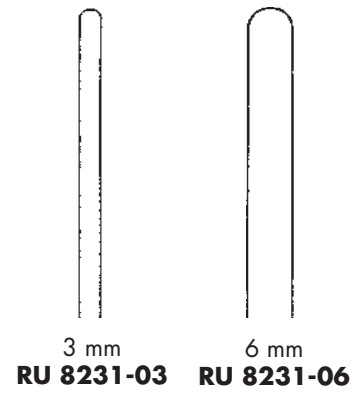

3 mm RU 8231-03
6 mm RU 8231-06



17 cm/6¾"
6 mm RU 5394-06
8 mm RU 5394-08



Mc Donald
19 cm/7½"
RU 5434-19

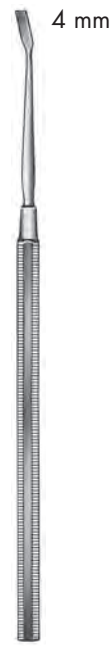

4 mm
16,5 cm/6½"
RU 8231-16



Freer
16,5 cm/6½"
RU 8232-18

**ELEVATORIEN
ELEVATORS**



18 cm/7"
RU 8236-18



Cottle
20 cm/8"
RU 8237-20



**Joseph (Cottle)
Masing**
22 cm/8¾"
RU 8238-22



Masing
20,5 cm/8¾" 22,5 cm/8¾"
RU 8239-20 RU 8239-22



Joseph
18 cm/7"
RU 8240-16
Periost-Elevator
Periosteum elevator

OSTEOTOME, PRÄPARATOREN
OSTEOTOMES, DISSECTORS



RU 8241-03
3,0 mm



RU 8241-13
3,0 mm



RU 8241-05
5,0 mm



RU 8241-15
5,0 mm



Paulsen
8 cm/3 1/8"



Paulsen
20,5 cm/8"



RU 8241-20
2,5 mm



RU 8241-21
3,5 mm



RU 8241-22
4,5 mm



RU 8241-30
5,0 mm



RU 8241-31
8,0 mm



Paulsen
20,5 cm/8"

**OSTEOTOME, FLACH- UND HOHLMEISSEL
OSTEOTOMES, CHISELS AND GOUGES**



18,5 cm/7¼"

Nasenseptum-Osteotome
Osteotomes for septum

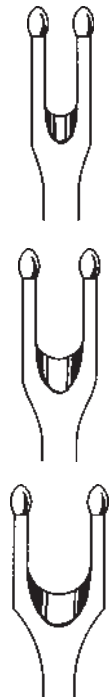

4 mm
RU 8243-04

6 mm
RU 8243-06

8 mm
RU 8243-08



4 mm

Freer

16 cm/6¼"
RU 8244-16

Flachmeißel, gebogen
Septum chisel, curved



4 mm

Freer

16 cm/6¼"
RU 8245-16

Flachmeißel, gerade
Septum chisel, straight



6 mm

Freer

15 cm/6"
RU 8246-15

Septum-Hohlmeißel
Septum gouge



Ballenger

16 cm/6¼"

- 2 mm **RU 8247-02**
- 4 mm **RU 8247-04**
- 6 mm **RU 8247-06**
- 8 mm **RU 8247-08**

Septum-Hohlmeißel
Septum gouges



Converse

18 cm/7"

- 2 mm **RU 8248-02**
- 3 mm **RU 8248-03**
- 4 mm **RU 8248-04**
- 5 mm **RU 8248-05**
- 6 mm **RU 8248-06**
- 7 mm **RU 8248-07**
- 8 mm **RU 8248-08**
- 9 mm **RU 8248-09**
- 10 mm **RU 8248-10**
- 11 mm **RU 8248-11**
- 12 mm **RU 8248-12**

Osteotome
Osteotomes

**OSTEOTOME
OSTEOTOMES**

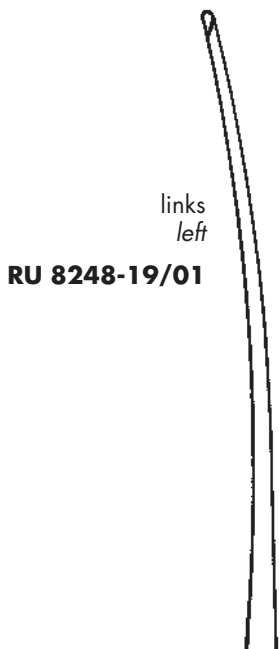

RU 8248-19/01



gerade/straight

Converse

19 cm/7½"

RU 8248-19

Osteotome/Osteotomes



*rechts
right*

RU 8248-19/02



Sheehan (Rubin)

16 cm/6¼"

- 2 mm **RU 8249-02**
- 3 mm **RU 8249-03**
- 4 mm **RU 8249-04**
- 5 mm **RU 8249-05**
- 6 mm **RU 8249-06**
- 7 mm **RU 8249-07**
- 8 mm **RU 8249-08**
- 9 mm **RU 8249-09**
- 10 mm **RU 8249-10**
- 11 mm **RU 8249-11**
- 12 mm **RU 8249-12**
- 15 mm **RU 8249-15**

Osteotome
Osteotomes



Mini-Lambotte

12,5 cm/5"

- 2 mm **RU 5332-02**
- 3 mm **RU 5332-03**
- 4 mm **RU 5332-04**
- 6 mm **RU 5332-06**
- 8 mm **RU 5332-08**
- 10 mm **RU 5332-10**
- 12 mm **RU 5332-12**
- 15 mm **RU 5332-15**

Osteotome
Osteotomes



12,5 cm/5"
gebogen/curved

- 2 mm **RU 5332-22**
- 4 mm **RU 5332-24**
- 6 mm **RU 5332-26**
- 8 mm **RU 5332-28**
- 10 mm **RU 5332-30**
- 12 mm **RU 5332-32**

Osteotome
Osteotomes

**FLACH- UND HOHLMEISSEL, OSTEOTOME
CHISELS AND GOUGES, OSTEOTOMES**

Hohlmeißel/*Gouges*



Killian
16 cm/6¼"
RU 8250-16

Killian-Claus
16 cm/6¼"
RU 8252-16



2 mm **RU 8253-02**
4 mm **RU 8253-04**
6 mm **RU 8253-06**
7 mm **RU 8253-07**
9 mm **RU 8253-09**
12 mm **RU 8253-12**

Cottle
18 cm/7"
Osteotome/*Osteotomes*

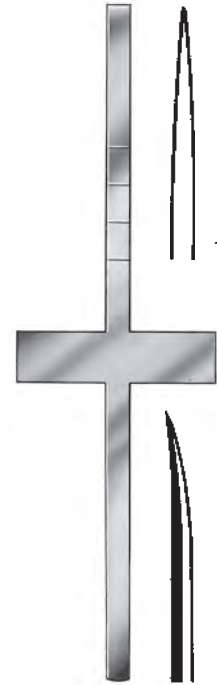

2 mm **RU 8253-22**
4 mm **RU 8253-24**
6 mm **RU 8253-26**
7 mm **RU 8253-27**
9 mm **RU 8253-29**
12 mm **RU 8253-32**

Cottle
18 cm/7"
Osteotome/*Osteotomes*

2 mm **RU 8253-52**
4 mm **RU 8253-54**
6 mm **RU 8253-56**
gebogen/*curved*



Cottle
18 cm/7"
2 mm **RU 8254-02**
4 mm **RU 8254-04**
6 mm **RU 8254-06**
7 mm **RU 8254-07**
9 mm **RU 8254-09**
12 mm **RU 8254-12**
Flachmeißel
Chisels



Cottle
18,5 cm/7¼"
gebogen/*curved*
2 mm **RU 8254-52**
4 mm **RU 8254-54**
6 mm **RU 8254-56**
Flachmeißel
Chisels

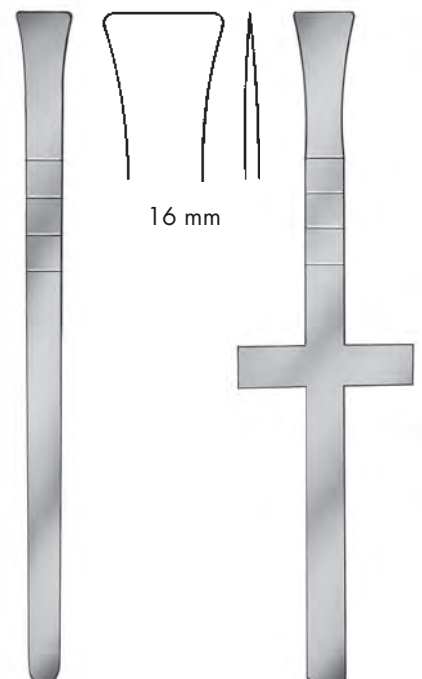

Cottle
18 cm/7"
RU 8255-16/01

Cottle
18 cm/7"
RU 8255-16/02
Osteotome/*Osteotomes*

SEPTUM-MEISSEL, OSTEOTOME
SEPTUM CHISELS, OSTEOTOMES

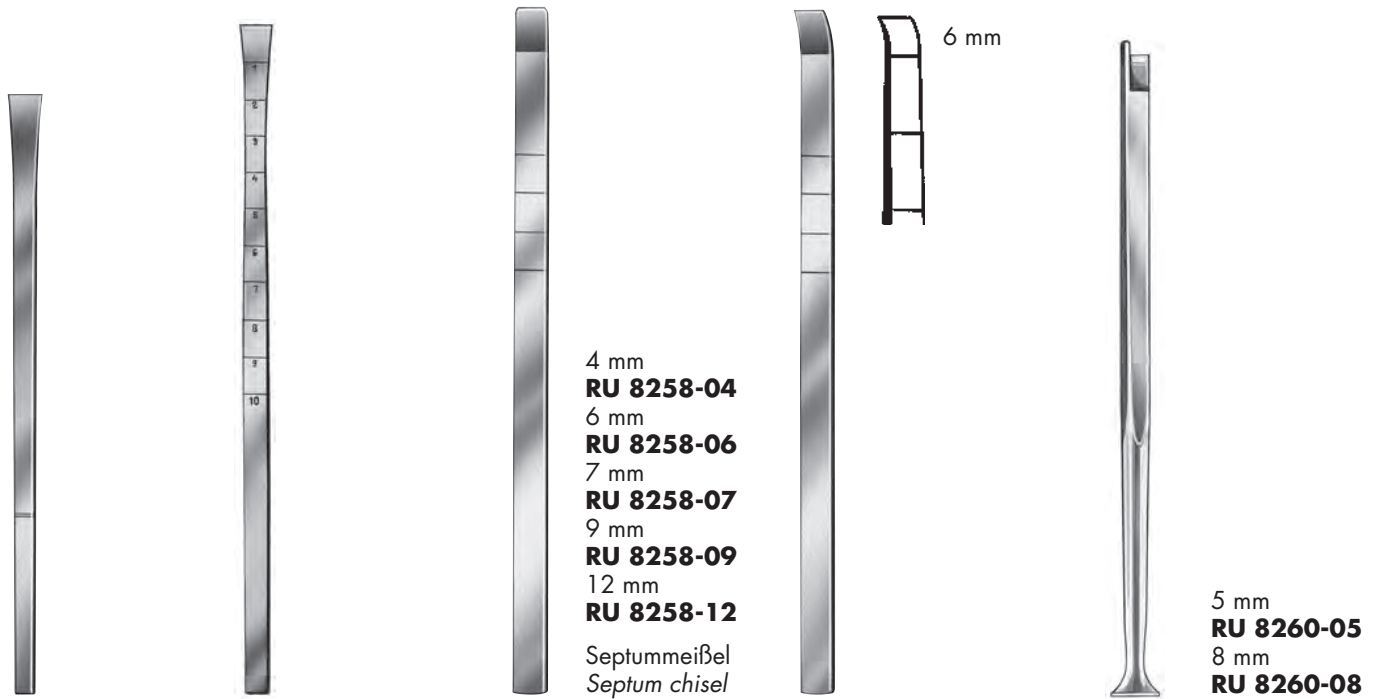

15 cm/6"
7 mm
RU 8256-08
Osteotome/Osteotomes

18 cm/7"
8 mm
RU 8256-58

Cottle
18 cm/7"

4 mm
RU 8258-04
6 mm
RU 8258-06
7 mm
RU 8258-07
9 mm
RU 8258-09
12 mm
RU 8258-12
Septummeißel
Septum chisel

Cottle
18 cm/7"
gebogen/curved
RU 8259-06
Osteotom/Osteotome

Fomon
17 cm/6¾"
Osteotome/Osteotomes

5 mm
RU 8260-05
8 mm
RU 8260-08

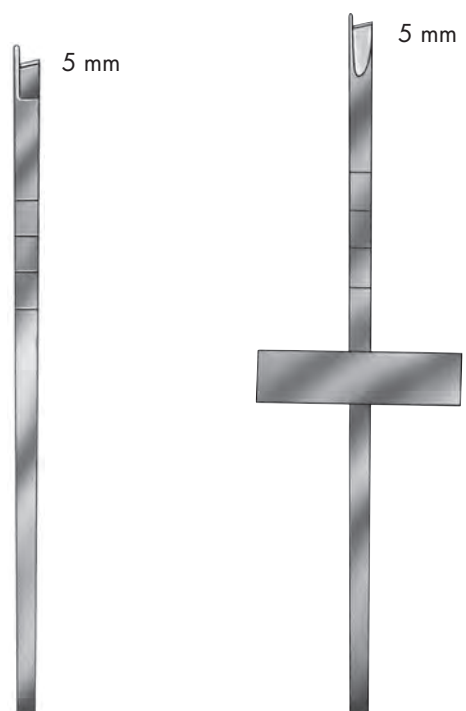

Cottle
18,5 cm/7¼"
RU 8260-25
Osteotom/Osteotome

Cottle
18,5 cm/7¼"
RU 8260-35
Osteotom/Osteotome



Walter
18 cm/7"
3 mm
RU 8261-03
4,5 mm
RU 8261-04
Flachmeißel mit Hohlkehle,
Spitzen verrundet
Chisel with notch, rounded tips



Walter
19 cm/7½"
2 mm
RU 8261-22
3 mm
RU 8261-23
4 mm
RU 8261-24
7 mm
RU 8261-27
9 mm
RU 8261-29
12 mm
RU 8261-32
Osteotome
Osteotomes

**OSTEOTOME
OSTEOTOMES**

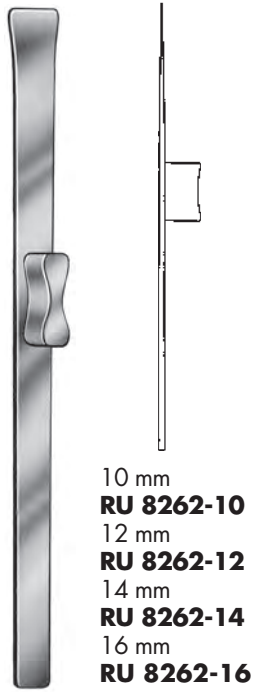

Rubin
18 cm/7"

10 mm
RU 8262-10
12 mm
RU 8262-12
14 mm
RU 8262-14
16 mm
RU 8262-16



RU 8263-01



**(Silver)
Masing**
17,5 cm/6⁷/₈"
RU 8263-02



RU 8263-03



links
left
RU 8263-21
rechts
right
RU 8263-22

Neivert
20,5 cm/8¹/₄"
gerade/*straight*
RU 8263-20



Guastella-Ey
18 cm/7"
RU 8263-31 **RU 8263-32**



3 mm



RU 8263-40

3 mm



Würzburger Modell
18 cm/7"
links/*left*
RU 8263-41

3 mm



rechts/*right*
RU 8263-42

OSTEOTOME, HOHLMEISSEL, HÄMMER
OSTEOTOMES, GOUGES, MALLETS



Cinelli
16 cm / 6¼"
Osteotome / Osteotomes

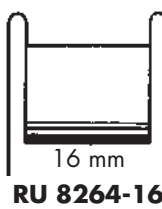
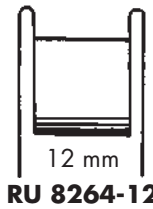
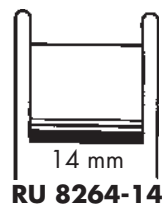
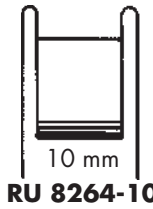

Mc Indoe
14,5 cm / 5¾"
Hohlmeißel / Gouges



RU 8264-81



RU 8264-83



RU 8264-85



Parkes
18 cm / 7"
RU 8264-65
Höcker-Hohlmeißel
Hump-gouge



Masing
17,5 cm / 6⅞"
RU 8265-00
Osteotom / Osteotome



Ersatzbackenpaar
Pair of spare jaws
RU 5799-51

18 cm / 7"
Ø 25 mm / 140 g
RU 5799-18



Cottle
19 cm / 7½"
Ø 30 mm / 350 g
1 Seite flach / 1 Seite konvex
1 side flat / 1 side convex
RU 5809-19

**NASENSÄGEN
NASAL SAWS**



Lindemann
20 cm/8"
RU 8266-20



Joseph
17 cm/6¾"



RU 8267-00



RU 8267-01



RU 8267-02

**NASENRASPELN
NASAL RASPS**

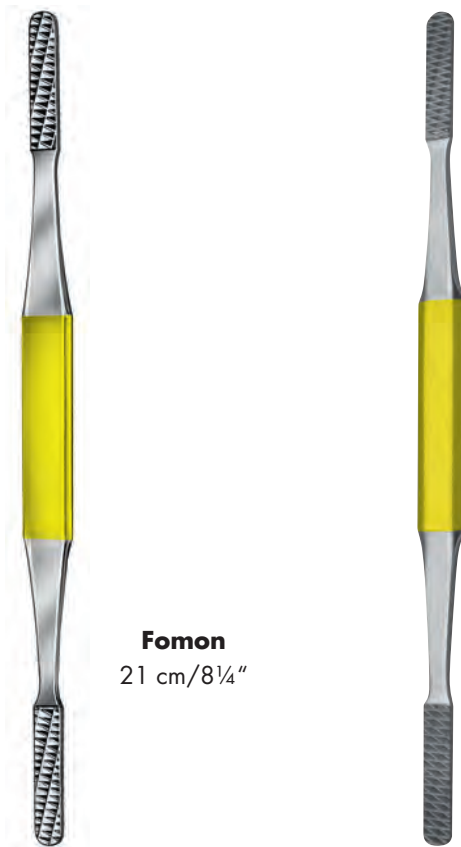
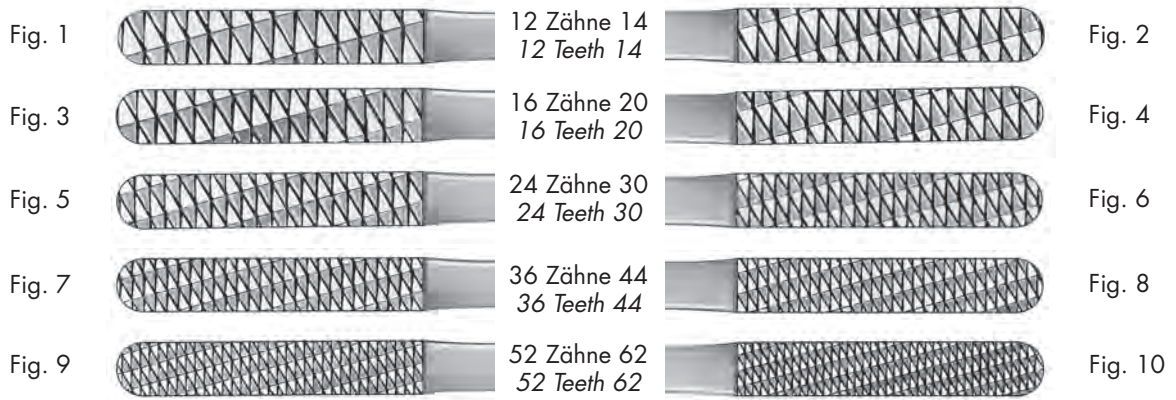

Fomon
21 cm/8¼"



Parkes
21 cm/8¼"

Maltz
17 cm/6¾"

	Zähne Teeth		feines Modell delicate Pattern
Fig. 1/2	12/14	RU 8268-01/12	RU 8268-02/12
Fig. 3/4	16/20	RU 8268-01/34	RU 8268-02/34
Fig. 5/6	24/30	RU 8268-01/56	RU 8268-02/56
Fig. 7/8	36/44	RU 8268-01/78	RU 8268-02/78
Fig. 9/10	52/62	RU 8268-01/99	RU 8268-02/99

Fig. 1	RU 8268-05/01	RU 8268-07/01
Fig. 2	RU 8268-05/02	RU 8268-07/02
Fig. 3	RU 8268-05/03	RU 8268-07/03
Fig. 4	RU 8268-05/04	RU 8268-07/04
Fig. 5	RU 8268-05/05	RU 8268-07/05
Fig. 6	RU 8268-05/06	RU 8268-07/06
Fig. 7	RU 8268-05/07	RU 8268-07/07
Fig. 8	RU 8268-05/08	RU 8268-07/08
Fig. 9	RU 8268-05/09	RU 8268-07/09
Fig. 10	RU 8268-05/10	RU 8268-07/10

**NASENRASPELN
NASAL RASPS**



Maltz
17,5 cm / 6¾"

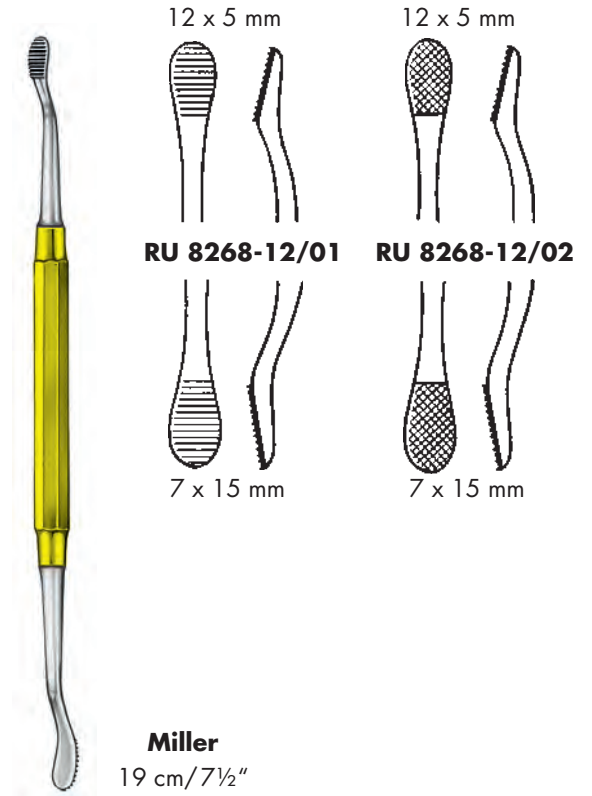
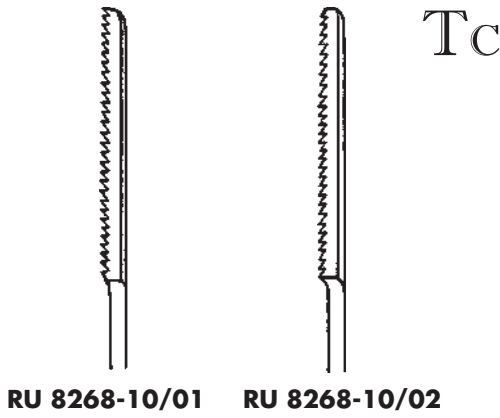

Diamantaufgabe/diamond jaw

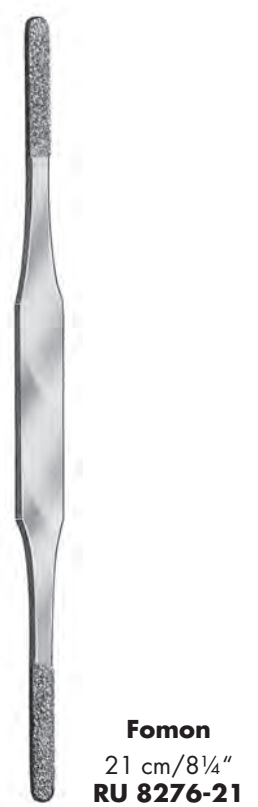
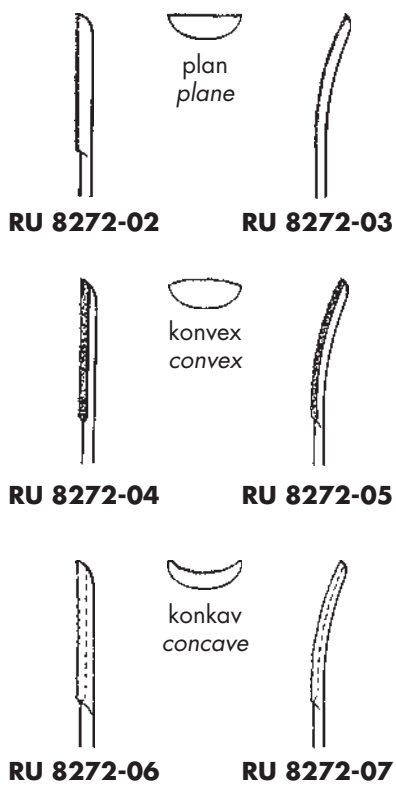

**NASENRASPELN
NASAL RASPS**



Miller
18 cm/7"
RU 5374-01

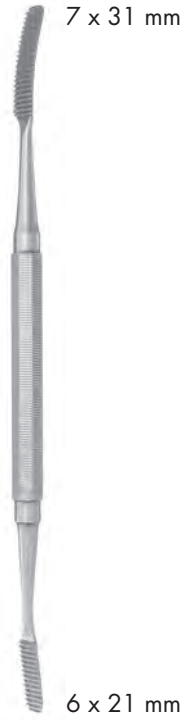

Miller
18 cm/7"
RU 5374-02



Miller
18 cm/7"
RU 5374-03



Maltz
18 cm/7"
RU 8270-18



Joseph
16 cm/6¼"



RU 8271-01



RU 8271-02

NASENRASPELN
NASAL RASPS

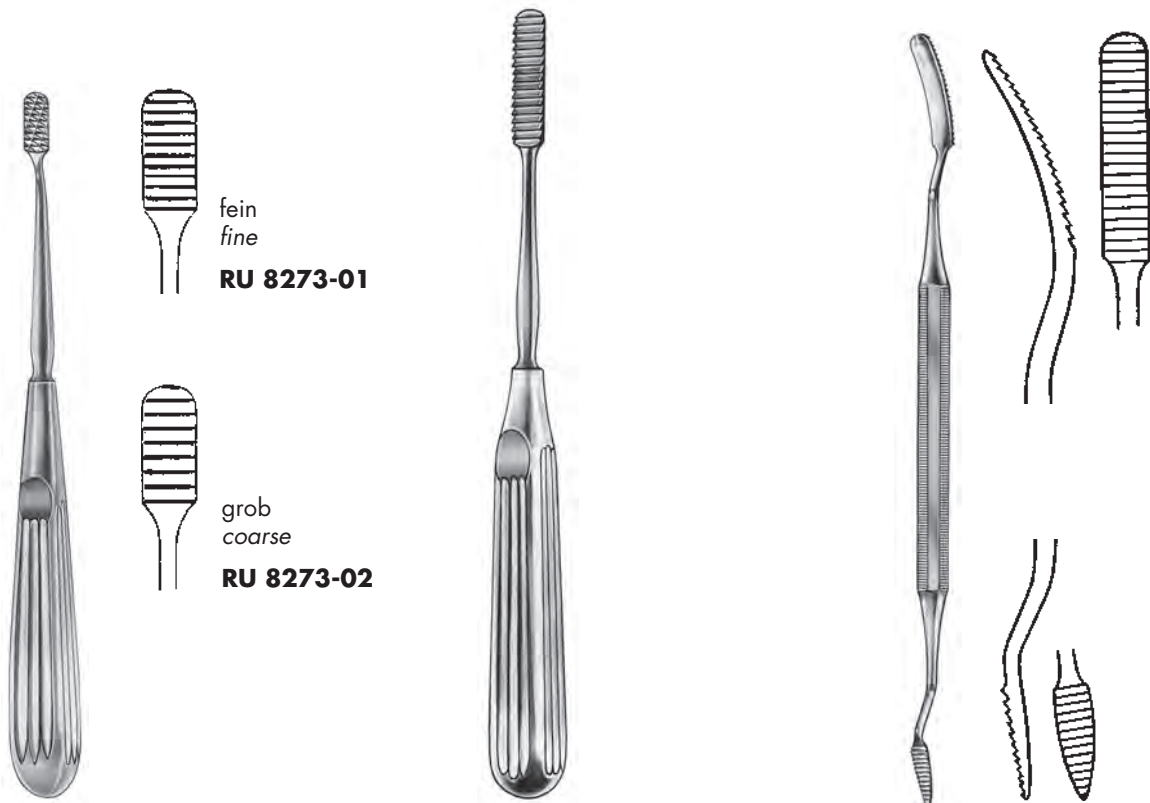

Lewis
18 cm/7"

Cottle
21 cm/8¼"
RU 8274-21

20,5 cm/8¼"
auf Zug schneidend
downwards stroke
RU 8274-50

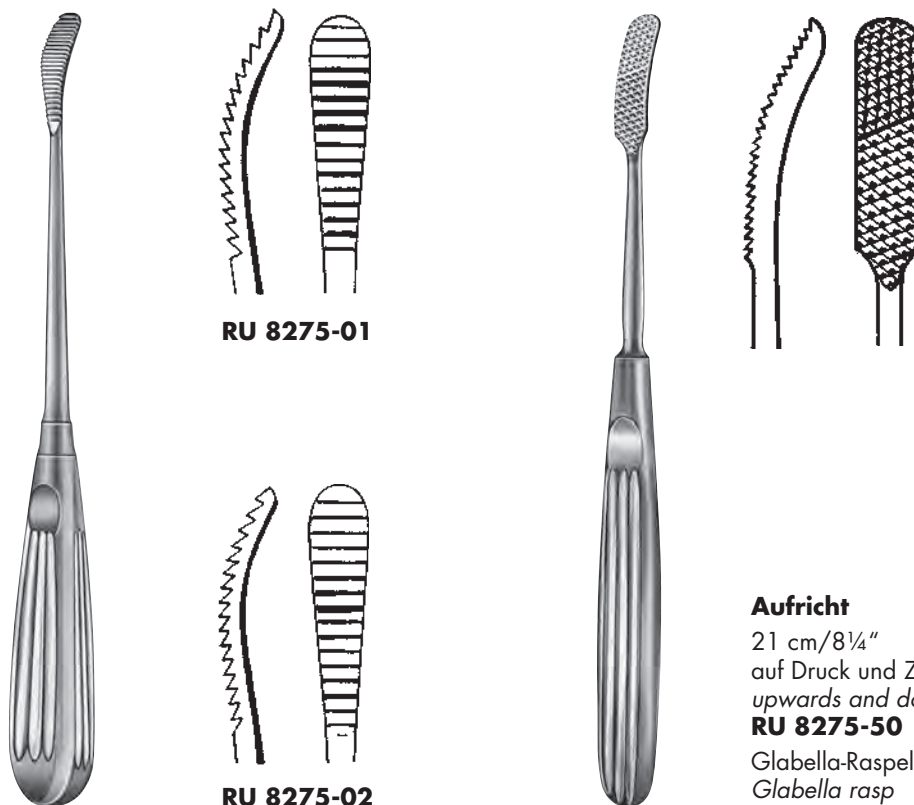

Aufricht
22 cm/8¾"

Aufricht
21 cm/8¼"
auf Druck und Zug schneidend
upwards and downwards stroke
RU 8275-50
Glabella-Raspel
Glabella rasp

NASENRASPELN, KNOCHEN-KNORPELQUETSCHER, METALLTABLETT
NASAL RASPS, BONE CRUSHER, PREPARATION TRAY

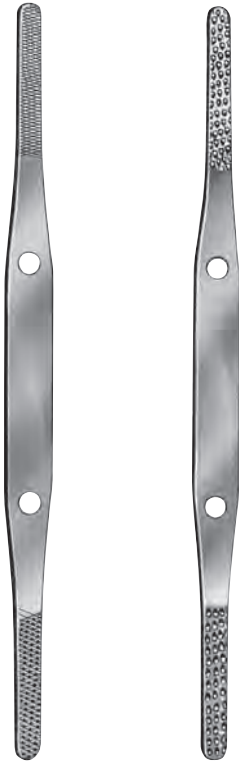

Fomon
21 cm/8¼"
RU 8276-01 RU 8276-02



**Kleinert-Kutz
(Fomon)**
21 cm/9"
RU 8276-50
doppelendig, vierseitig
mit je 2 Seiten fein (flach) und grob (konvex)
double-ended, 4-sided
each of 2 sides fine (flat) and coarse (convex)

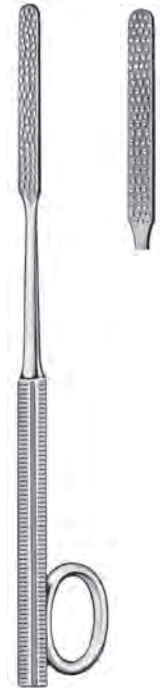

Gallaher
18 cm/7"
RU 8277-01

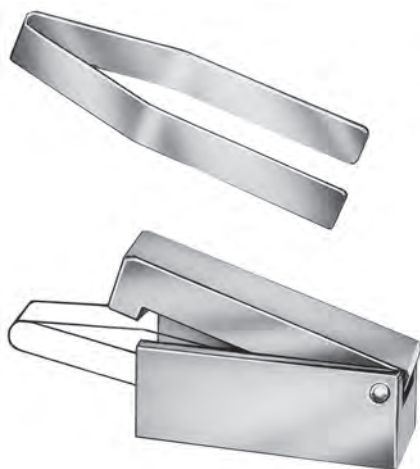

RU 8278-00
Knochen-Knorpelquetscher
Bone crusher

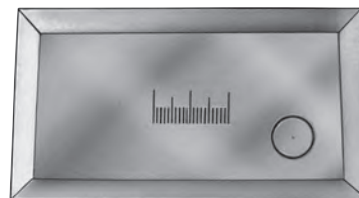

92 x 54 mm
RU 7908-24/01
Präpariertablett aus Metall
Preparation tray of metal

**HÄKCHEN, ZIRKEL
HOOKS, CALIPER**



Gillies
18 cm/7"
RU 6296-01



Gillies
18 cm/7"
RU 6296-02



Kilner
15 cm/6"
RU 6297-15



RU 6392-13
RU 6392-18

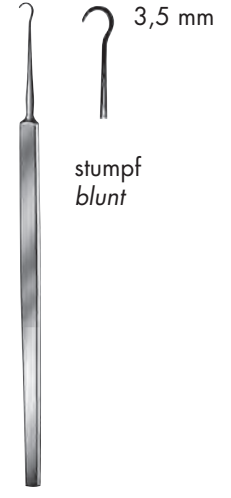

RU 6393-13
RU 6393-18



Knapp
13 cm/5"
RU 9405-13



Rollet
13 cm/5"
RU 9406-13



16 cm/6¼"



Graefe
RU 4430-03/01 **RU 4430-03/02**

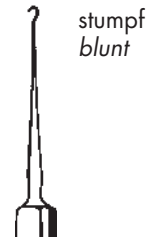

**HÄKCHEN, GEWEBEKRALLE, FADENGABEL
HOOKS, TISSUE PICK, SUTURE PUSHER AND KNOT TIER**



18,5 cm/7¼"
90° abgewinkelt
90° angled
RU 8822-06



Yasargil
18,5 cm/7¼"
RU 8826-00



Yasargil
18,5 cm/7¼"
RU 8826-01



Yasargil
18,5 cm/7¼"
RU 8826-02



Yasargil
18,5 cm/7¼"
RU 8826-03

Fadenführer geknöpft
Ligature guides, probe pointed



18,5 cm/7¼"
1,0 mm **RU 8831-10**
1,8 mm **RU 8831-18**
Gewebekralle
Tissue Pick



1,0 mm



1,8 mm



18,5 cm/7¼"
RU 8835-13
Fadengabel
Suture pusher and knot tier

**HÄKCHEN
HOOKS**



Cottle
16 cm/6¼"
RU 8281-16



180°
retrograd
gebogen
retrograde
curved
Cottle
16 cm/6¼"
RU 8282-03



90°
RU 8283-01



RU 8283-02



RU 8283-03



16,5 cm/6"
RU 8283-04

14,5 cm/5½"



Cottle
15 cm/6"
RU 8284-01



Lange
22 cm/8¾"
RU 8286-22



Fraenkel-Neivert
20,5 cm/8"
RU 8286-52

RU 8280-15 entnehmen Sie bitte Seite 312
For RU 8280-15 please refer to page 312

**HÄKCHEN
HOOKS**



Fomon
17 cm/6¾"
RU 8287-17



Müller
15 cm/6"
RU 8288-01



Müller
15 cm/6"
RU 8288-02



Freer
15 cm/6"
RU 8290-15



Joseph
15 cm/6"
RU 8280-15



Joseph
16 cm/6¼"



2 mm
RU 8292-02



5 mm
RU 8292-05



7 mm
RU 8292-07



10 mm
RU 8292-10

**HÄKCHEN
HOOKS**



McIndoe
15 cm/6"
RU 8293-09



Fomon
16 cm/6¼"
RU 8294-16



Neivert (Masing)
20 cm/8"
RU 8298-20



Neivert
19,5 cm/7¾"
RU 8299-19



Cottle-Neivert
20 cm/8"
RU 8299-20



Cottle
14,5 cm/5¾"
RU 8300-14

**NASENFLÜGELHAKEN
ALAR RETRACTORS**



Cottle
14,5 cm/5¾"
RU 8301-01



Cottle
14,5 cm/5¾"
RU 8301-02

10 x 12 mm



Cottle
15 cm/6"
RU 8302-15

13 x 24 mm



Cottle
16 cm/6¼"
RU 8302-30

6 x 12 mm



Masing
14 cm/5½"
RU 8302-31



Kilner
8 cm/3⅛"
scharf/sharp

10 mm **RU 8303-08**
13 mm **RU 8303-09**



Cottle
5,5 cm/2¼"
RU 8303-30

10 mm



Converse
12 cm/4¾"
RU 8304-12



Aufricht
16 cm/6¼"
8 x 45 mm **RU 8310-16**
8 x 60 mm **RU 8310-60**



Cottle
10 cm/4"
RU 8312-10

**NASENHAKEN
NASAL RETRACTORS**



Cottle

14 cm/5½"
Satz zu 4 Stück – Set/4 sizes:
RU 8315-00

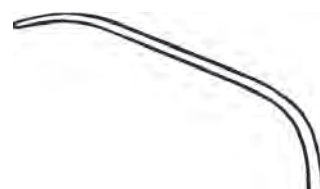

40 mm
RU 8315-01

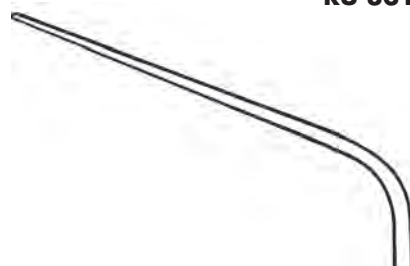

50 mm
RU 8315-02

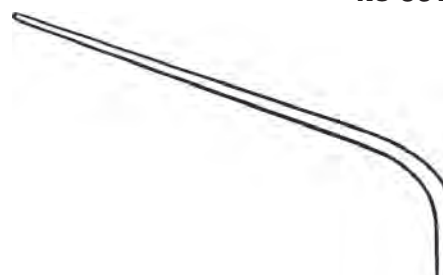

55 mm
RU 8315-03

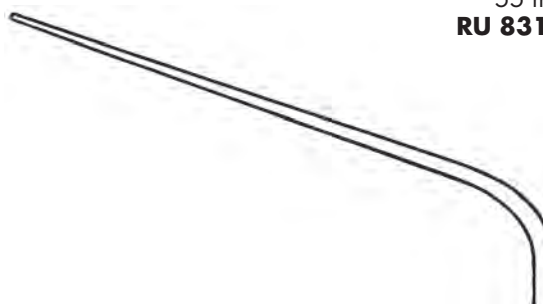

70 mm
RU 8315-04

HAKEN, NASENFRAKTURAUFRICHTER
HOOKS, SEPTUM ELEVATORS

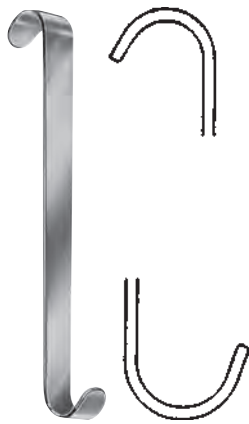

Luer
11 cm/4½"
RU 4479-11

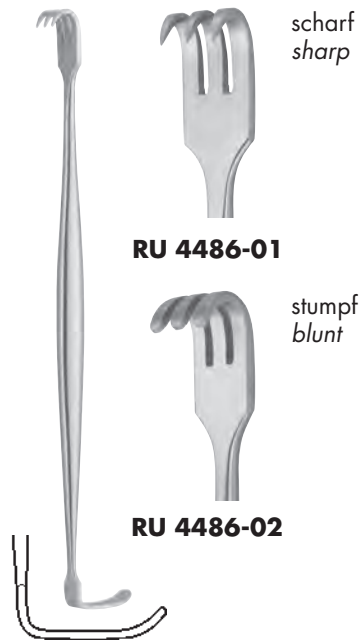

Senn-Miller
16 cm/6¼"

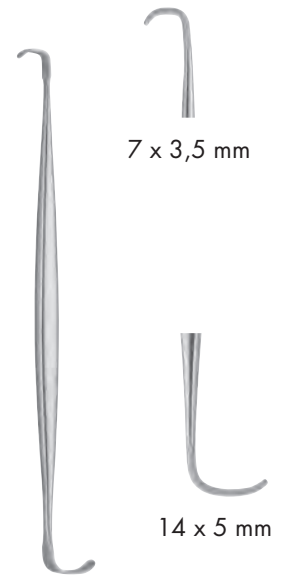

Ragnell-Davis
15 cm/6"
RU 4488-14

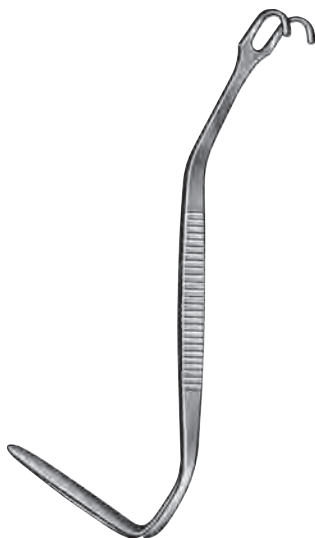

Walter
13 cm/5"
RU 8316-12



Boies
18 cm/7"
RU 8326-01



Goldmann
20 cm/8"
RU 8326-02

REPOSITIONSZANGEN, SEPTUMRICHTZANGEN
REPOSITION FORCEPS, SEPTUM STRAIGHTENING FORCEPS

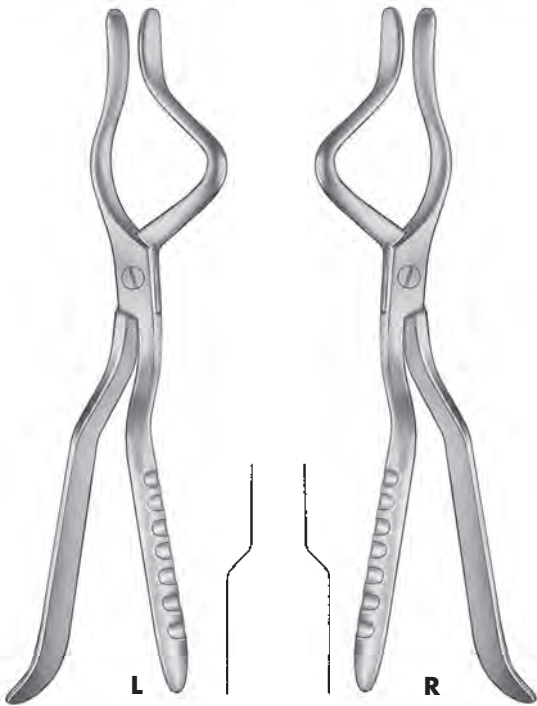

Rowe
23 cm/9"

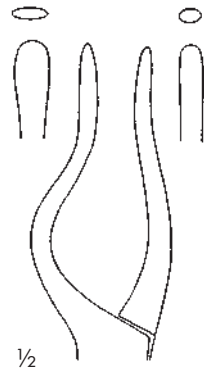

Fig. 1

für die linke Seite
for the left side

RU 8327-01

für die rechte Seite
for the right side

RU 8327-11

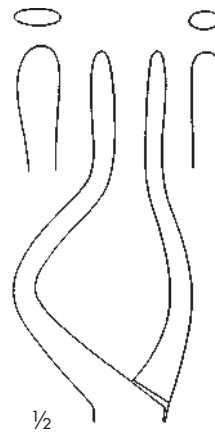

Fig. 2

RU 8327-02

RU 8327-12

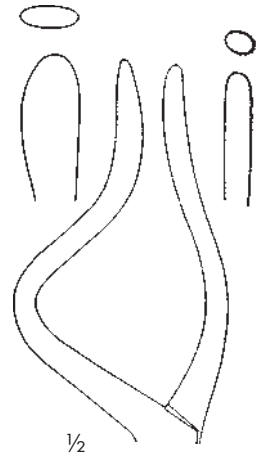

Fig. 3

RU 8327-03

RU 8327-13



Walsham
23 cm/9"



RU 8328-01

rechts und links ver-
wendbar
applicable for
left and right



RU 8328-02

rechts
right



RU 8328-03

links
left



Cottle-Walsham
22 cm/8 3/4"
zerlegbar/detachable
RU 8329-22

SEPTUMRICHTZANGEN
SEPTUM STRAIGHTENING FORCEPS



Asch
23 cm/9"
abgewinkelt/angular
RU 8330-23



Kressner
20 cm/8"
3 mm **RU 8331-20**
4 mm **RU 8331-21**



Rubin
20 cm/8"
RU 8333-20



RU 8333-50
Schutzkappe alleine
Protecting cap only

ADENOTOMIE TONSILLEKTOMIE

ADENOTOMY TONSILLECTOMY

Seiten 319 - 346

Pages 319 - 346



Übersicht

Scheren, Wundhaken, Ringmesser
Adenotome, Mundsperrer, Bruststützen
Zungendrucker, -spatel
Zungenzangen, Fingerschützer
Tamponstopfer, -zangen
Tonsillennadeln, -messer, -zangen
Ligatur-Instrumente
Elevatoren, Fasszangen, Klemmen
Tonsillenschnürer, Tonsillotome
Conchotome, Kompressorium

Overview

Scissors, retractors, adenoid curettes
Adenotomes, mouth gags, chest support
Tongue depressors
Tongue holding forceps, finger protector
Gauze packers, sponge holding forceps
Tonsil needles, -knives, -forceps
Ligature instruments
Dissectors, grasping-, haemostatic forceps
Tonsil snares, tonsillotomes
Punches, compressor

Seiten / Pages

320-323
323-332
332-334, 328-329
334
335, 337
335, 337-338
336
338-341
342-344
345

PRÄPARIERSCHEREN, TONSILLEN SCHEREN
DISSECTING SCISSORS, TONSIL SCISSORS



Metzenbaum-Fino

18 cm/7"

RU 1330-18

20 cm/8"

RU 1330-20

Tc



Metzenbaum-Fino

RU 1336-18

RU 1336-20



Metzenbaum

RU 1331-18

RU 1331-20

Tc



Metzenbaum

RU 1334-18



11 cm/4½"
RU 1706-10
Speichelgangschere
Salival scissors



Böttcher
18 cm/7"
RU 1810-18



Good
19 cm/7½"
RU 1845-19

**WUNDHAKEN, RINGMESSER
RETRACTORS, ADENOID CURETTES**

18 x 22 mm



17 x 16 mm

Baby-Roux
13 cm/5"
RU 4492-13



Middeldorpf



14 x 17 mm
21,5 cm/8½"
RU 4551-01



20 x 22 mm
22 cm/8¾"
RU 4551-02



26 x 30 mm
23,5 cm/9¼"
RU 4551-03



Brünings-Brunk
22,5 cm/8¾"
RU 8363-19
Kieferhöhlenhaken
Antrum retractor

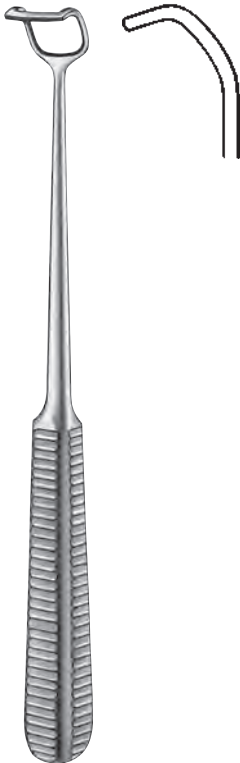

Beckmann
22 cm/8¾"

RU 8350-01



RU 8351-01

RU 8350-02



RU 8351-02

RU 8350-03



RU 8351-03

RU 8350-04



RU 8351-04

RU 8350-05



RU 8351-05

RU 8350-06



RU 8351-06



Negus
22 cm/8¾"

**RINGMESSER
ADENOID CURETTES**



Barnhill
20 cm/8"

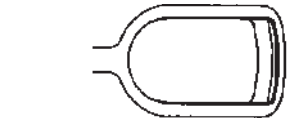

RU 8352-01



RU 8352-02

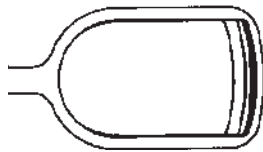

RU 8352-03



RU 8352-04



Beckmann
20 cm/8"



RU 8353-01



RU 8353-02



RU 8353-03



RU 8353-04



RU 8353-05

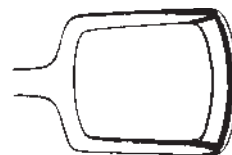

RU 8353-06



RU 8354-00/01
8,5 mm



RU 8354-00
10 mm



RU 8354-01
13 mm



RU 8354-02
15 mm

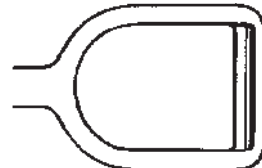

RU 8354-03
16,5 mm

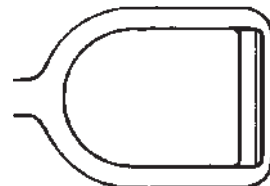

RU 8354-04
18 mm

St. Clair-Thompson
22 cm/8¾"
Ringmesser mit Fangkorb
Adenoid currettes with cage

**RINGMESSER, ADENOTOME
ADENOID CURETTES, ADENOTOMES**



Fig. 1
12 mm



Fig. 2
16 mm



Fig. 3
18 mm

La Force

23 cm/9"

- Fig. 1 **RU 8361-01**
- Fig. 2 **RU 8361-02**
- Fig. 3 **RU 8361-03**



Shambaugh

21 cm/8¼"

- Fig. 1 **RU 8362-01**
- Fig. 2 **RU 8362-02**
- Fig. 3 **RU 8362-03**

Ersatzklingen für/
Spare blades for
RU 8361-.../RU 8362-...



- Fig. 1 **RU 8361-11**
- Fig. 2 **RU 8361-12**
- Fig. 3 **RU 8361-13**

**MUNDSPERRER
MOUTH GAGS**



Kilner-Doughty

komplett mit 3 Spateln Fig. 1–3
complete with 3 tongue-blades Fig. 1–3
RU 8380-00

Sperrer allein
Gag only
RU 8380-10

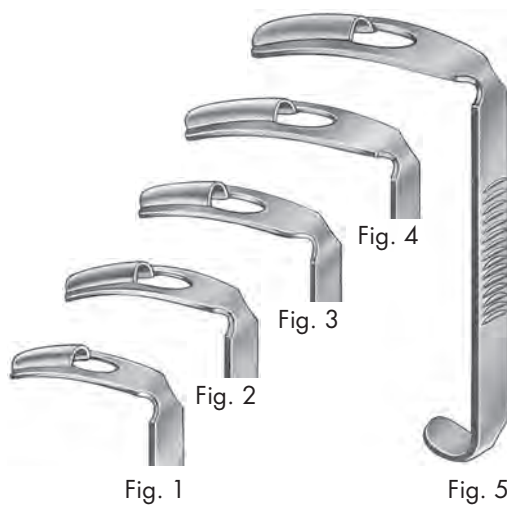

Zungenspatel/Tongue blades

Fig. 1	28 x 65 mm	RU 8380-01
Fig. 2	32 x 75 mm	RU 8380-02
Fig. 3	37 x 80 mm	RU 8380-03
Fig. 4	41 x 94 mm	RU 8380-04
Fig. 5	46 x 103 mm	RU 8380-05

extra schmale Modelle/narrow pattern

Fig. 1	18 x 57 mm	RU 8380-11
Fig. 2	22 x 67 mm	RU 8380-12
Fig. 3	25 x 75 mm	RU 8380-13

Alle auf den Seiten 324-329 abgebildeten Griffe und Spatel sind untereinander austauschbar.
All the frames and blades illustrated on page 324 to 329 are interchangeable.

**MUNDSPERRER
MOUTH GAGS**



Davis-Meyer

komplett mit 7 Spateln
complete with 7 tongue blades
Fig. 1 bis/to 7
RU 8381-00

Sperrer allein
Gag only
RU 8381-10

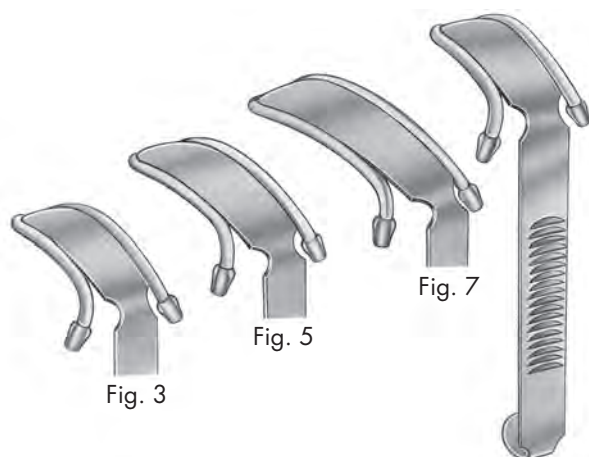

RU 8381-11
Gaumenplatte
Palate blade

- | | | |
|--------|---------------|-------------------|
| Fig. 1 | 29,0 x 70 mm | RU 8381-01 |
| Fig. 2 | 30,5 x 75 mm | RU 8381-02 |
| Fig. 3 | 31,5 x 80 mm | RU 8381-03 |
| Fig. 4 | 32,5 x 85 mm | RU 8381-04 |
| Fig. 5 | 33,5 x 95 mm | RU 8381-05 |
| Fig. 6 | 33,8 x 100 mm | RU 8381-06 |
| Fig. 7 | 34,0 x 105 mm | RU 8381-07 |

Zungenspatel mit doppeltem Ätherrohr
Tongue blades with anesthetic tubes on both sides

**MUNDSPERRER
MOUTH GAGS**

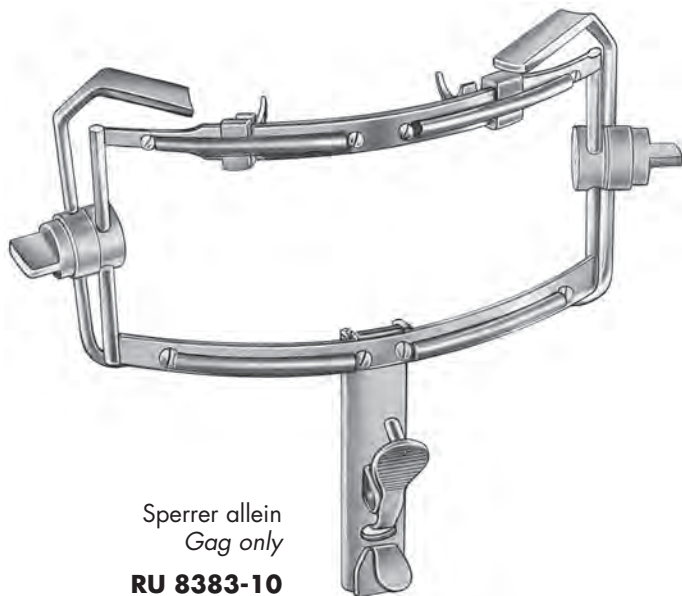

Sperrer allein
Gag only
RU 8383-10

Dingmann

komplett mit
3 auswechselbaren Zungenspateln (Fig. 1 – 3),
2 drehbaren Wangenhaltern,
2 beweglichen Zahnhaken
und Fadenführer

complete with
3 interchangeable tongue blades (Fig. 1 – 3),
2 rotatable cheek holders,
2 movable tooth hooks
and thread guide

RU 8383-00

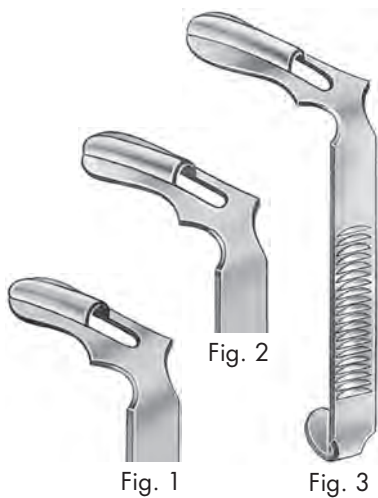

- Fig. 1 24 x 62 mm **RU 8383-01**
- Fig. 2 28 x 65 mm **RU 8383-02**
- Fig. 3 31 x 75 mm **RU 8383-03**

Zungenspatel
Tongue blades

**MUNDSPERRER
MOUTH GAGS**



Davis-Boyle
für Erwachsene/*for adults*
komplett mit 5 Spateln Fig. 1 – 5
complete with 5 tongue blades Fig. 1 – 5

RU 8384-00



Davis-Boyle
für Kinder/*for children*
komplett mit 5 Spateln Fig. 1 – 5
complete with 5 tongue blades Fig. 1 – 5

RU 8384-50

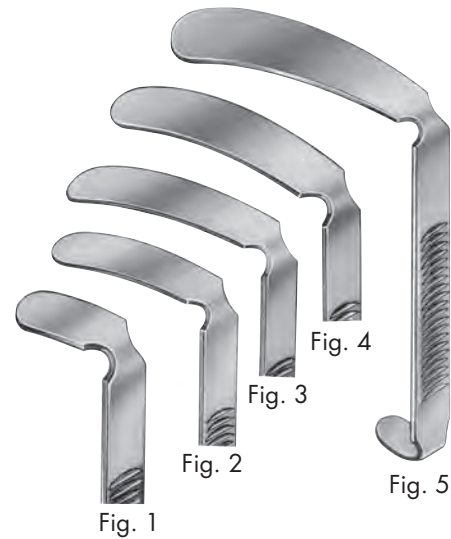

Fig. 1	21 x 30 mm	RU 8384-01
Fig. 2	23 x 65 mm	RU 8384-02
Fig. 3	24 x 80 mm	RU 8384-03
Fig. 4	25 x 93 mm	RU 8384-04
Fig. 5	26 x 108 mm	RU 8384-05

Zungenspatel/*tongue blades*

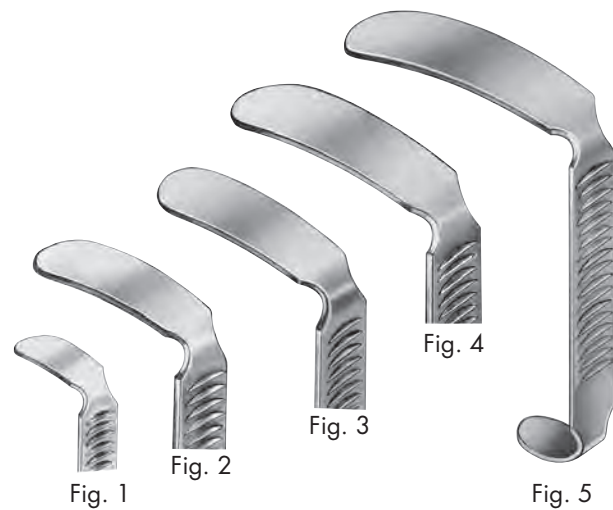

Fig. 1	17 x 26 mm	RU 8384-51
Fig. 2	19 x 46 mm	RU 8384-52
Fig. 3	20 x 58 mm	RU 8384-53
Fig. 4	22 x 71 mm	RU 8384-54
Fig. 5	22 x 80 mm	RU 8384-55

Zungenspatel/*tongue blades*

auswechselbare Silikoneinlagen für beide Sperrer
removable silicone inserts for both gags

RU 8384-99

MUNDSPERRER, ZUNGENSPELTEL
MOUTH GAGS, TONGUE BLADES



Mc Ivor

komplett mit 3 Spateln Fig. 1 – 3
complete with 3 tongue blades Fig. 1 – 3

RU 8386-00



Fig. 1 23 x 70 mm **RU 8386-01**
Fig. 2 25 x 86 mm **RU 8386-02**
Fig. 3 26 x 100 mm **RU 8386-03**

Zungenspatel/tongue blades



Herberhold

Fig. 1 28 x 63 mm **RU 8387-01**
Fig. 2 33 x 73 mm **RU 8387-02**
Fig. 3 37 x 87 mm **RU 8387-03**
Fig. 4 40 x 94 mm **RU 8387-04**



Fig. 2 23 x 65 mm **RU 8388-02**
Fig. 3 24 x 80 mm **RU 8388-03**
Fig. 4 25 x 93 mm **RU 8388-04**
Fig. 5 26 x 108 mm **RU 8388-05**
Fig. 6 26 x 114 mm **RU 8388-06**

Zungenspatel/tongue blades



Modell Würzburg

Fig. 1 28 x 66 mm **RU 8389-01**
Fig. 2 32 x 75 mm **RU 8389-02**
Fig. 3 34 x 83 mm **RU 8389-03**
Fig. 4 37 x 93 mm **RU 8389-04**
Fig. 5 38 x 100 mm **RU 8389-05**

**ZUNGENSPEL, BRUSTSTÜTZE
TONGUE BLADES, CHEST SUPPORT**

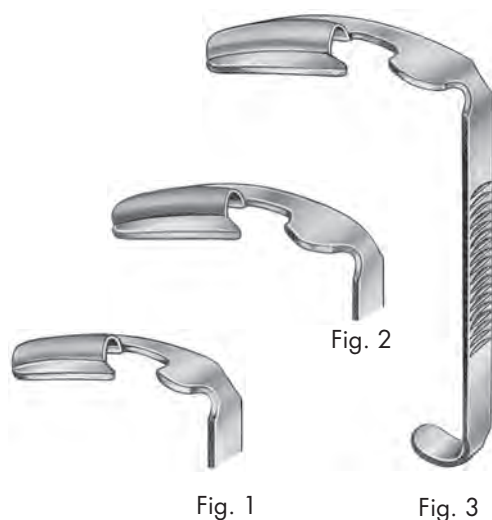
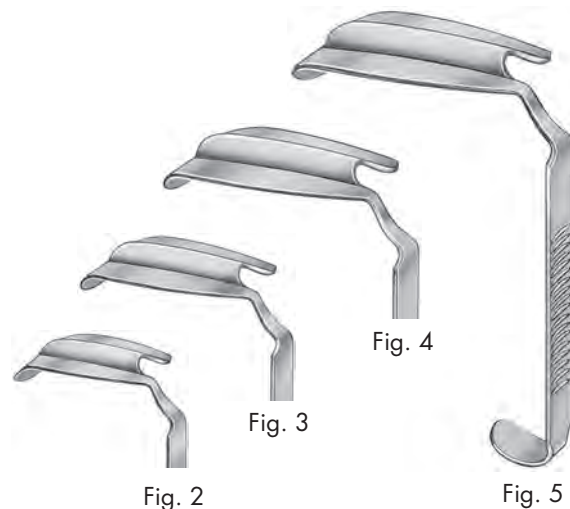

Fig. 1 28 x 65 mm **RU 8389-21**
Fig. 2 32 x 75 mm **RU 8389-22**
Fig. 3 37 x 80 mm **RU 8389-23**

mit seitlichem Einschnitt/lateral slot



	links/left	rechts/right
Fig. 2 23 x 58 mm	RU 8390-02	RU 8390-52
Fig. 3 27 x 72 mm	RU 8390-03	RU 8390-53
Fig. 4 34 x 87 mm	RU 8390-04	RU 8390-54
Fig. 5 37 x 95 mm	RU 8390-05	RU 8390-55

mit seitlichem Einschnitt/lateral slot



**Bruststütze für Mundsperrer
Chest support for mouth gag**

für Erwachsene/for adults **RU 8395-00**
für Jugendliche/for adolescent **RU 8395-02**
für Kinder/for children **RU 8395-03**

Alle auf den Seiten 324–329 abgebildeten Griffe und Spatel sind untereinander austauschbar.
All the frames and blades illustrated on pages 324-329 are interchangeable.

**MUNDSPERRER
MOUTH GAGS**



Baby-Molt
10 cm/4"
RU 8402-10



**Molt
Doyen-Collin**
11 cm/4½" **RU 8402-11**
14 cm/5½" **RU 8402-14**



Roser-König
16 cm/6¼" **RU 8405-16**
19 cm/7½" **RU 8405-19**



Denhart
12 cm/4¾"
RU 8406-12



Heister
13 cm/5"
RU 8408-13



Heister
13 cm/5"
RU 8409-13
mit Teflonauflage
with teflon insert

**MUNDSPERRER
MOUTH GAGS**



Fergusson-Ackland
14,5 cm/5¾" **RU 8410-20**

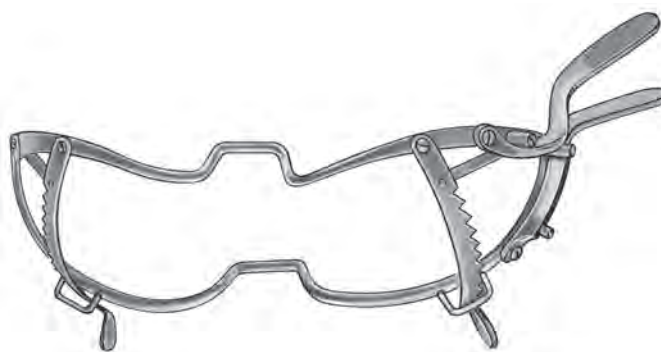

Whitehead
11 cm/4¼" **RU 8412-11**
15 cm/6" **RU 8412-15**

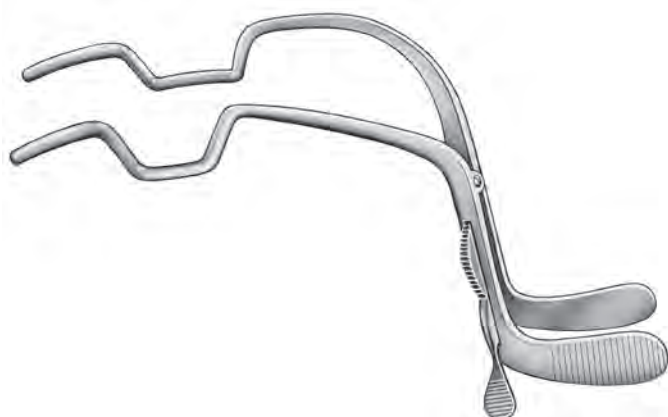

Jennings
RU 8417-00

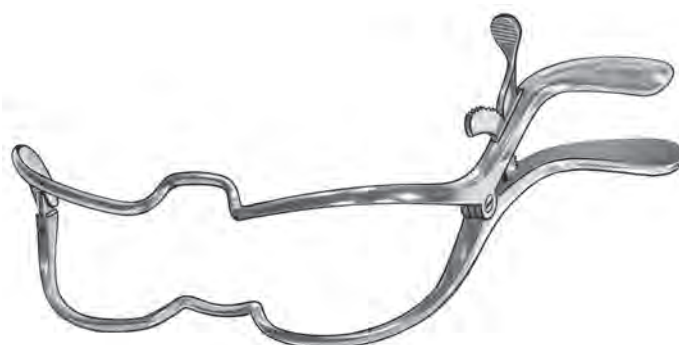

Jennings
9 cm/3½" **RU 8416-09**
11 cm/4¼" **RU 8416-11**
13 cm/5" **RU 8416-13**
15 cm/6" **RU 8416-15**

MUNDSPERRER, ZUNGENDRÜCKER
MOUTH GAGS, TONGUE DEPRESSORS

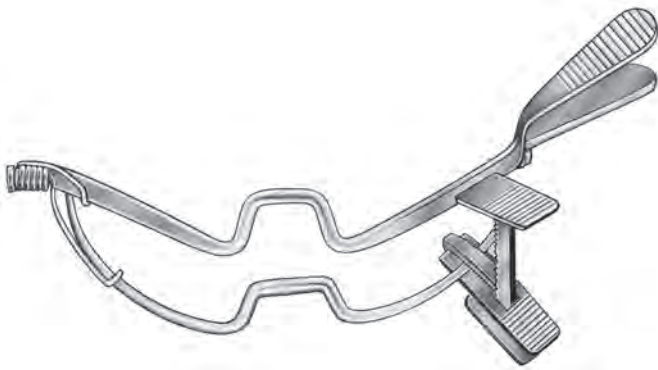

Seemann-Seiffert

9 cm/3½" **RU 8418-09**
11 cm/4¼" **RU 8418-11**
13 cm/5" **RU 8418-13**

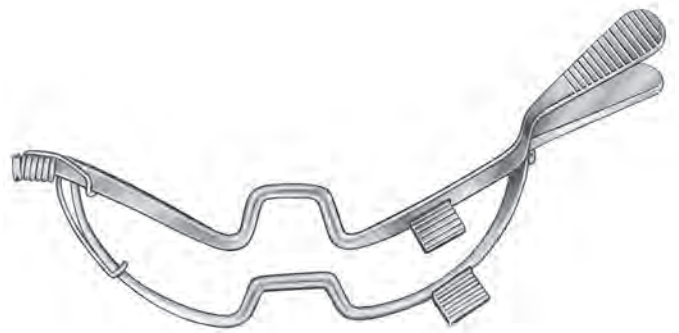

Seemann-Seiffert
Standard

11 cm/4¼" **RU 8419-11**
13 cm/5" **RU 8419-13**



Sternberg

12 cm/4¾" **RU 8421-12**
14 cm/5½" **RU 8421-14**
16 cm/6¼" **RU 8421-16**



Moritz-Schmidt

19 cm/7½"
RU 8424-19

**ZUNGENSPATEL
TONGUE DEPRESSORS**



Hartmann
16,5 cm/6½"
RU 8425-15



Tobold
14 cm/5½"
RU 8426-14



Frenzel
16,5 cm/6½"
RU 8429-16



14,5 cm/5¾"
RU 8430-14



14,5 cm/5¾"
RU 8431-14



Kroenig
15 cm/6"
RU 8432-15



Mayo
17 cm/6¾"
RU 8433-17



Buchwald
18 cm/7"
RU 8434-18

ZUNGENSPEL, ZUNGENZANGEN, FINGERSCHÜTZER
TONGUE DEPRESSORS, TONGUE HOLDING FORCEPS, FINGER PROTECTORS



Bruenings
19 cm/7½"
RU 8440-19



RU 8442-01 RU 8442-02

Wieder

Packung à 100 Stück
package of 100 pcs.



16 cm/6¼"
RU 8445-16
Holzspatel
Wooden spatula



Collin
16 cm/6¼"
RU 8450-16



Young
17 cm/6¾"
RU 8452-17

Paar Gummipolster, allein
Pair of rubber jaws, only

RU 8452-50



Langenbeck
Ø 22 mm **RU 8455-01**
Ø 24,5 mm **RU 8455-02**
Ø 26,5 mm **RU 8455-03**
Fingerschützer
Finger protectors

TAMPONSTOPFER, TONSILLENNADELN
GAUZE PACKERS, TONSIL NEEDLES

Tamponstopfer/Gauze packers

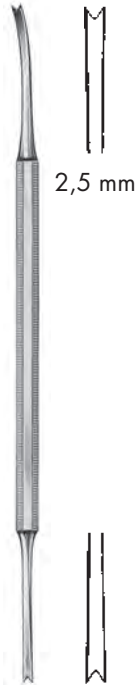

2,5 mm

Luniatschek
18 cm/7"
RU 8458-01

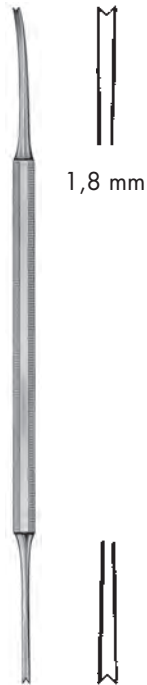

1,8 mm

Luniatschek
18 cm/7"
RU 8458-02



Luniatschek
19 cm/7½"
RU 8544-19



Claus
23 cm/9"
RU 8502-23



Hurd
21 cm/8¼"
RU 8503-01
für rechte Hand
for right hand



Hurd
21 cm/8¼"
RU 8503-02
für linke Hand
for left hand



Nager
24 cm/9½"
RU 8512-24

**LIGATURINSTRUMENTE
LIGATURE INSTRUMENTS**

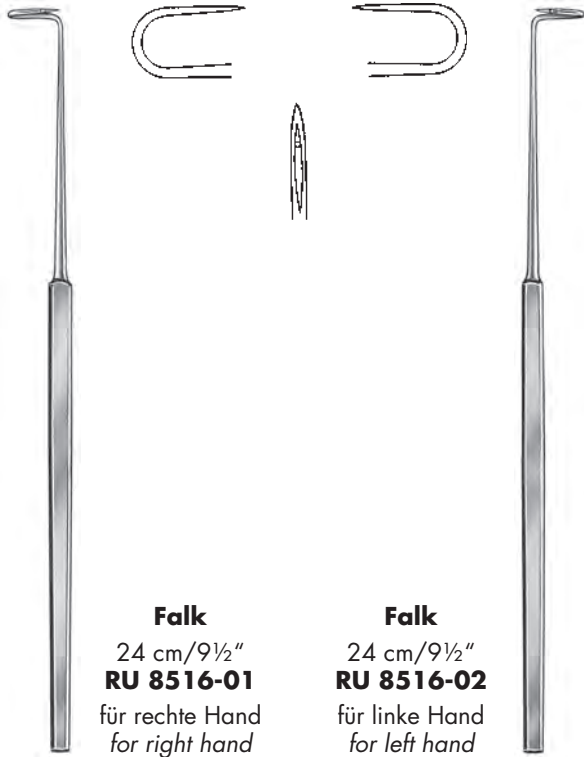

Falk
24 cm/9½"
RU 8516-01
für rechte Hand
for right hand

Falk
24 cm/9½"
RU 8516-02
für linke Hand
for left hand



Claus van Eicken
21 cm/8¼"
RU 8519-21



Roeder
26 cm/10¼"
RU 8520-26

Stärke 0/size 0
RU 8520-50
Stärke 1/size 1
RU 8520-51
Marline Rapit-Schlingen (12 St.)
Marline Rapit snares (12 pcs.)



Negus
20 cm/8"
RU 8524-20



RU 8525-01



RU 8525-02



RU 8525-03

20 cm/8"

TONSILLENABSZESSZANGEN, TAMPONZANGEN, TONSILLENMESSER
TONSIL ABSCESS FORCEPS, SPONGE HOLDING FORCEPS, TONSIL KNIVES



Thilenius
20 cm/8"
RU 8529-19

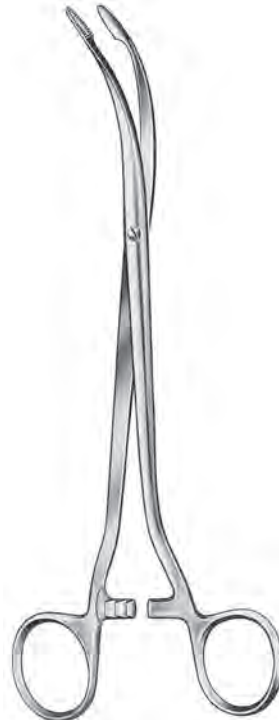

Duplay
19 cm/7½"
RU 8530-19



TONSILLENMESSER, ELEVATORIEN
TONSIL KNIVES, ELEVATORS



Abraham
21 cm/8¼"
RU 8538-21



Bruenings
23 cm/9"
RU 8539-23



Abraham
19 cm/7½"
RU 8540-19

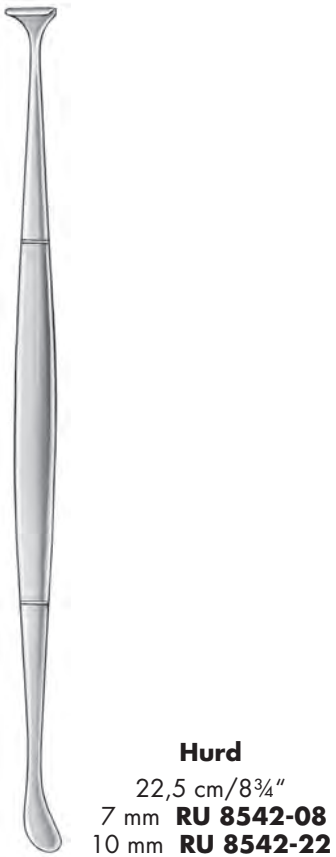

Hurd
22,5 cm/8¾"
7 mm **RU 8542-08**
10 mm **RU 8542-22**

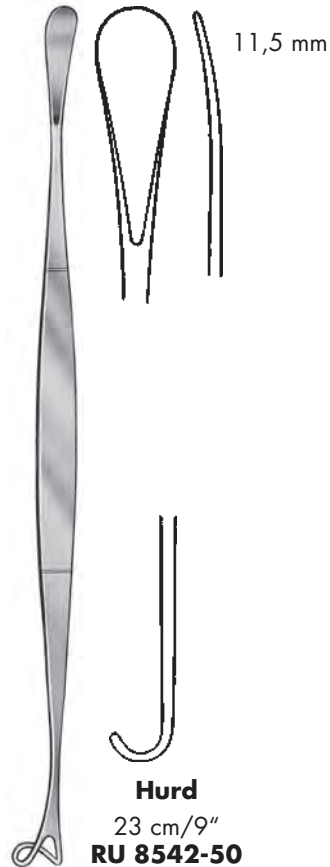

Hurd
23 cm/9"
RU 8542-50



19,5 cm/7¾"
RU 8543-19

ELEVATORIEN
ELEVATORS

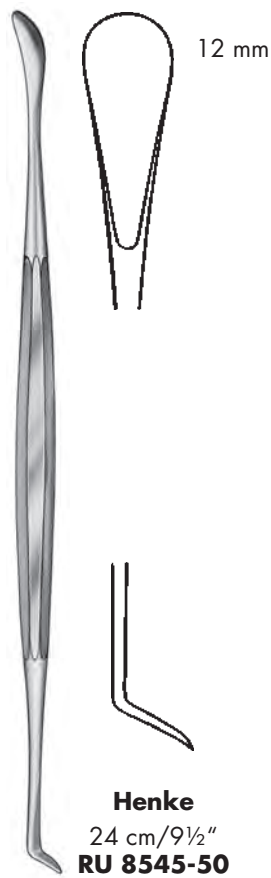
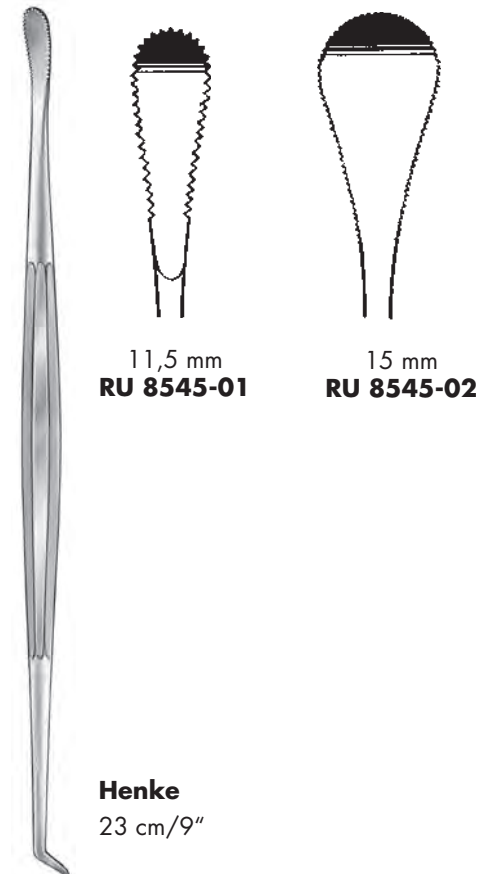
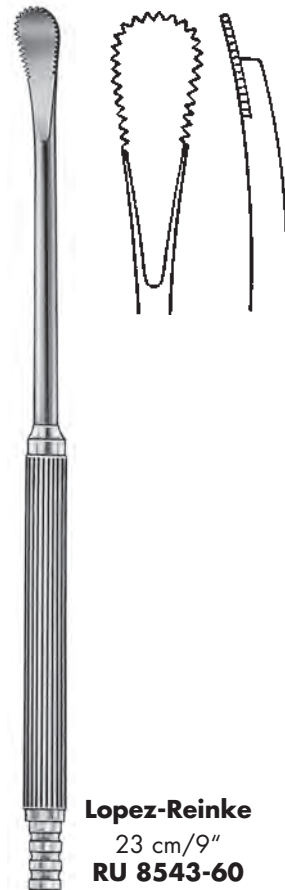
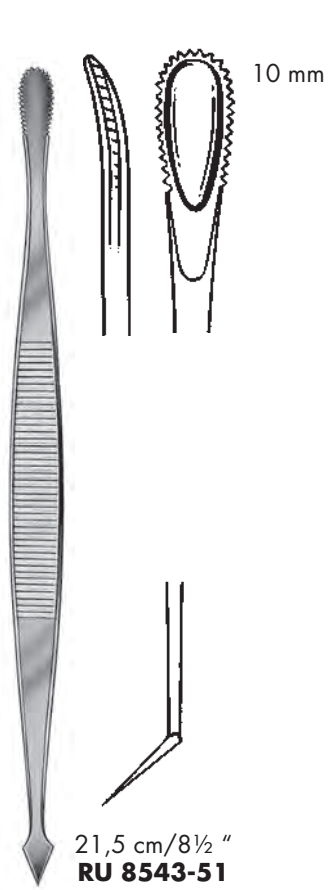

**ELEVATORIEN, TONSILLENFASSZANGEN
DISSECTORS, TONSIL GRASPING FORCEPS**



Haslinger
17 cm/6¾"
RU 8548-16



Hofer
24 cm/9½"
RU 8549-24



Allis
15 cm/6"
Zähne 4:5 **RU 6500-15**
teeth 5:6 **RU 6502-15**



Museux
20 cm/8"
gerade/straight **RU 8550-20**
gebogen/curved **RU 8551-20**



Ballenger
21,5 cm/8½"
RU 8553-21



White
18 cm/7" **RU 8555-18**
23 cm/9" **RU 8555-23**

**TONSILLENFASSZANGEN, TONSILLENKLEMMEN
TONSIL GRASPING FORCEPS, TONSIL HEMOSTATIC FORCEPS**



Colver
19 cm / 7½"
gerade/straight gebogen/curved
RU 8556-19 RU 8557-19



Abraham
20 cm / 8"
RU 8559-20



Blohmke
20 cm / 8"
RU 8560-20



Schnidt
19 cm / 7½"



RU 8570-01

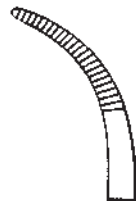

RU 8570-02



Schnidt
19 cm / 7½"



RU 8570-03

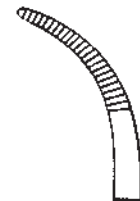

RU 8570-04

TONSILLENCHNÜRER
TONSIL SNARES



Eves
28 cm/11"
RU 8600-28



Eves
28 cm/11"
RU 8602-28



Bruenings
28 cm/11"
RU 8604-28

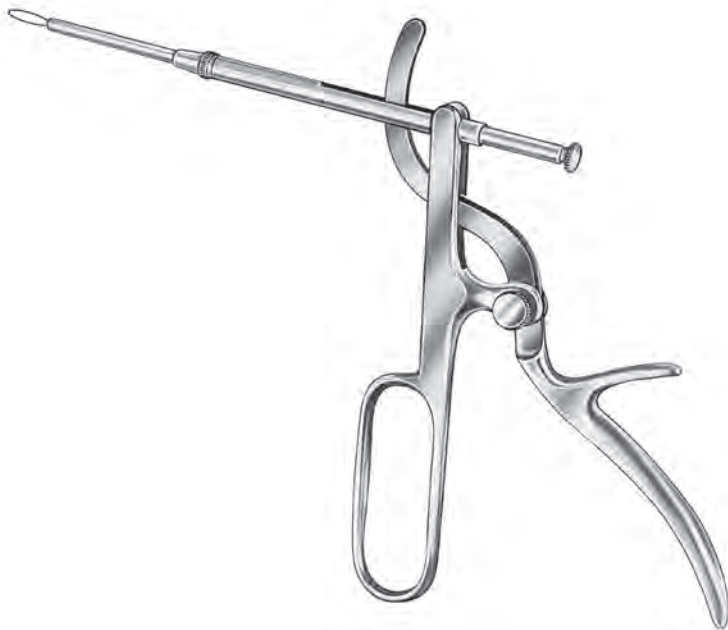

Tyding
mit 1 geraden Aufsatz
with 1 straight tip
RU 8608-00



RU 8608-10

gerader Aufsatz allein
straight tip only



RU 8608-11

Veeder-Aufsatz allein
Veeder tip only

TONSILLEN SCHNÜRER
TONSIL SNARES



Brown
mit 1 geraden Aufsatz
with 1 straight tip
RU 8610-00

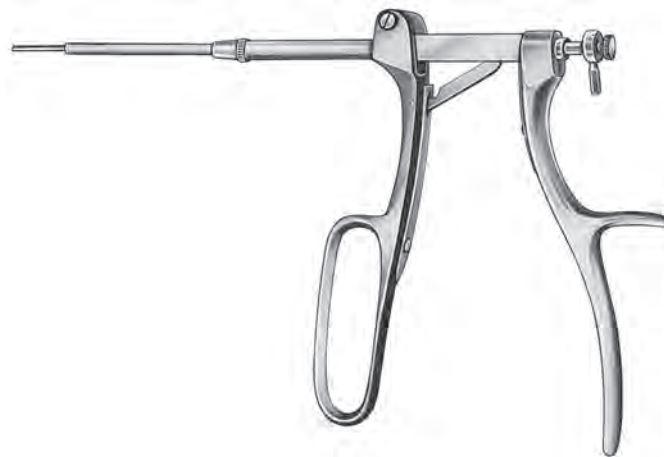

Sage
mit automatischer Sperre
with automatic ratchet
RU 8611-00



	12 St./12 pcs.	100 St./100 pcs.
0,3 mm	RU 8609-03	RU 8609-03/00
0,4 mm	RU 8609-04	RU 8609-04/00
0,45 mm	RU 8609-05	RU 8609-05/00
0,5 mm	RU 8609-06	RU 8609-06/00

Schnürerdraht
Snare wire

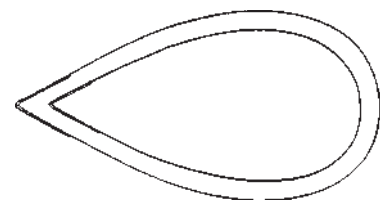

	100 St./100 pcs.
40 mm	RU 8609-40
50 mm	RU 8609-50

Schnürerschlingen
Snare loops

**TONSILLOTOME
TONSILLECTOMES**



Daniels

mit Doppelklinge zum Quetschen und Schneiden
with double blade for squeezing and cutting



Fig. 1
16 mm
RU 8614-01



Fig. 2
20 mm
RU 8614-02



Fig. 3
24 mm
RU 8614-03



Fig. 1
24 mm
RU 8615-01



Fig. 2
26 mm
RU 8615-02



Fig. 3
29 mm
RU 8615-03

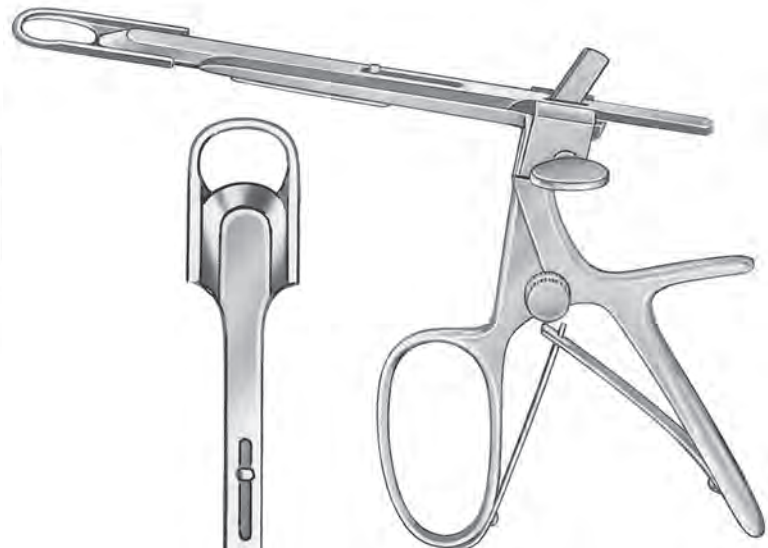

Sluder-Ballenger

komplett mit 3 Aufsätzen (Fig. 1 – 3)
complete, with 3 tips (Fig. 1 – 3)

RU 8615-00

RU 8615-10

Griff allein
Handle only

— Aufsätze, allein/Tips only —

TONSILLEN-CONCHOTOME
TONSIL PUNCHES



Hartmann

- Ø 13 mm **RU 8616-13**
- Ø 15 mm **RU 8616-15**
- Ø 17 mm **RU 8616-17**

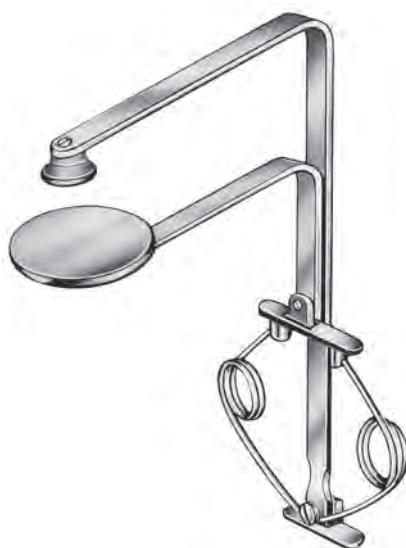

Vetter
RU 8617-50



SINUSKOPIE

SINUSCOPY

Seiten 347 - 376

Pages 347 - 376

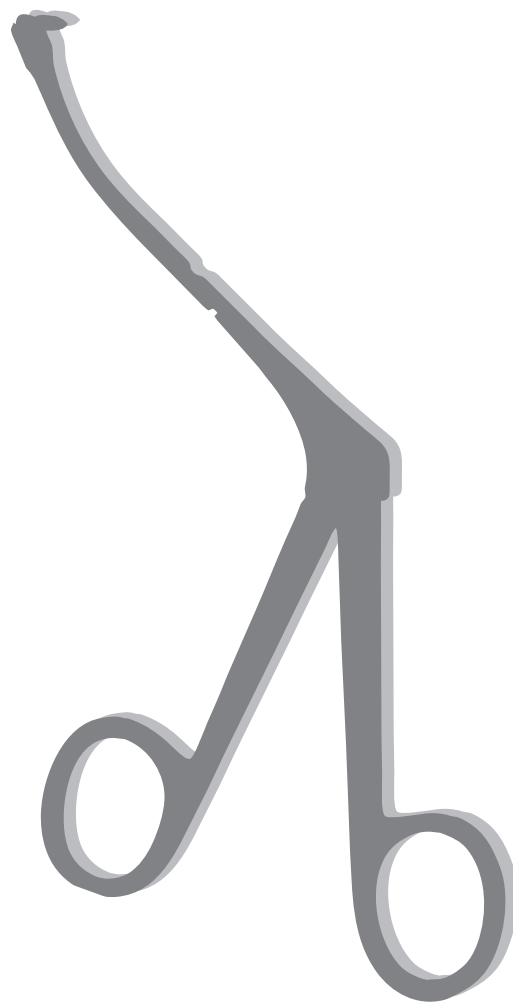

Übersicht

Wundhaken, Kieferhöhlenhaken
Wangen-, Lippenhalter, Sperrer
Zangen, Zängchen, Scheren, Stanzen
Knochenstanzen
Löffel, Messer, Meißel, Raspeln
Elevatoren, Küretten, Kanülen, Sonden
Sinuskopie-Trokare, Spül-, Saugrohre

Overview

Retractors, antrum retractors
Cheek-, lip retractors, antrum retractors
Forceps, scissors, punches
Bone rongeurs
Curettes, knives, chisels, rasps
Elevators, curettes, cannulas, dilators
Sinuscopy trocars, wash-, suction cannulas

Seiten / Pages

350
351-352
353-365, 368
366
367, 368-370
371-373, 375
374-375



Bei dieser Katalog-Auflage handelt es sich um einen Nachdruck mit geringfügigen Änderungen; daher entfällt der ursprüngliche Inhalt auf dieser Seite.

This catalogue edition is a reprint with minor amendments. This is why the initial content of this page has been removed.



Bei dieser Katalog-Auflage handelt es sich um einen Nachdruck mit geringfügigen Änderungen; daher entfällt der ursprüngliche Inhalt auf dieser Seite.

This catalogue edition is a reprint with minor amendments. This is why the initial content of this page has been removed.

**WUNDHAKEN, KIEFERHÖHLENHAKEN
RETRACTORS, ANTRUM RETRACTORS**



Baby-Roux
13 cm/5"
RU 4492-13



Middeldorpf



RU 4551-01

14 x 17 mm
21,5 cm/8½"



RU 4551-02

20 x 22 mm
22 cm/8¾"



RU 4551-03

26 x 30 mm
23,5 cm/9¼"



Brünings-Brunk
22,5 cm/8¾"
RU 8363-19

**WANGEN- UND LIPPENHALTER, KIEFERHÖHLENSPERRER
CHEEK AND LIP RETRACTORS, ANTRUM RETRACTORS**



19 cm/7½"
RU 8420-19



Sternberg

12 cm/4¾" **RU 8421-12**
14 cm/5½" **RU 8421-14**
16 cm/6¼" **RU 8421-16**

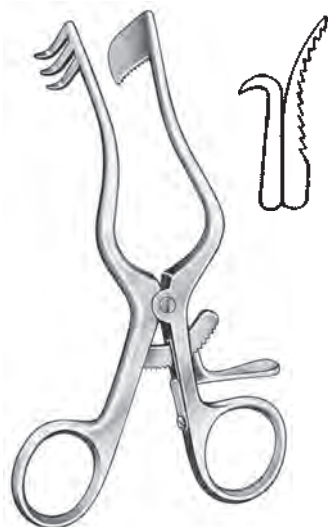

Perkins
13 cm/5"
rechtes Blatt voll/scharf gezahnt
solid blade right/coarse serrated
RU 4688-01

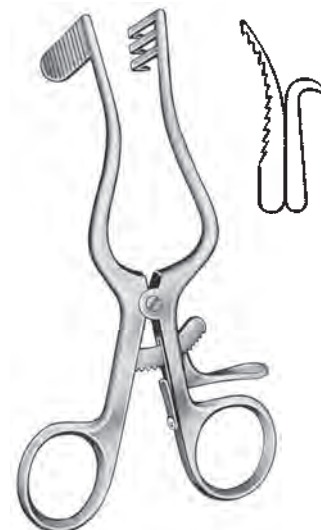
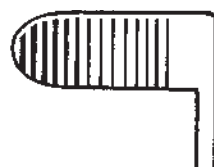

Perkins
13 cm/5"
linkes Blatt voll/scharf gezahnt
solid blade left/coarse serrated
RU 4688-02

**KIEFERHÖHLENSPERRER
ANTRUM RETRACTORS**



Plester
11 cm/4½"
RU 4690-01



Plester
11 cm/4½"
RU 4690-02



Plester
13 cm/5"
scharf/sharp stumpf/blunt
RU 4691-01 RU 4691-02



Blatt/blade 17 cm/6¾"
25 x 17 mm **RU 4694-05**



17 cm/6¾"
RU 4694-06

verstellbar/adjustable



Fisch
17 cm/6¾"
RU 4694-11

verstellbar/adjustable

**NASENZANGEN
NASAL CUTTING FORCEPS**



Strümpel-Voss
11 cm/4¼"
RU 7884-11



Strümpel
8,5 cm/3¾" **RU 7884-09**
10,0 cm/4" **RU 7884-10**

PROCLEAN®

- einfache Reinigung
- gründliche Desinfektion
- sorgfältige Sterilisation
- *easy cleaning*
- *thorough disinfecting*
- *accurate sterilizing*

Maul Jaw	Schaftlänge length of shaft		Schaftlänge length of shaft
	12 cm/4¾"	17 cm/6¾"	12 cm/4¾"
3 x 10 mm	RU 8080-00 RU 8080-00P*	RU 8080-10	RU 8081-00 RU 8081-00P*
2 x 10 mm	RU 8080-02	RU 8080-12	-
2,5 x 8 mm	RU 8080-03	-	-

* = PROCLEAN®



Takahashi

SEPTUMZANGEN, BIOPSIE- UND FASSZANGEN
SEPTUM FORCEPS, BIOPSY AND GRASPING FORCEPS



Watson-Williams
19 cm / 7 1/2"



1,0 x 19 mm
Strycken
RU 8094-00

1,2 x 19 mm
RU 8094-00/01



Hajek
RU 8095-00



Hajek
RU 8102-01 3,0 mm x 12 mm
RU 8102-02 3,5 mm x 14 mm
RU 8102-03 4,0 mm x 16 mm

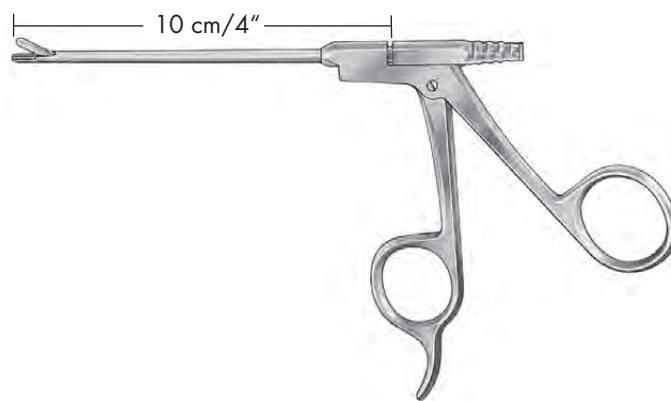

RU 8089-00 gerade, straight



RU 8089-01 30° aufgewinkelt, 30° angled up
Biopsie- und Faßzange
mit Absaugkanal
*Biopsy and grasping forceps
with suction channel*



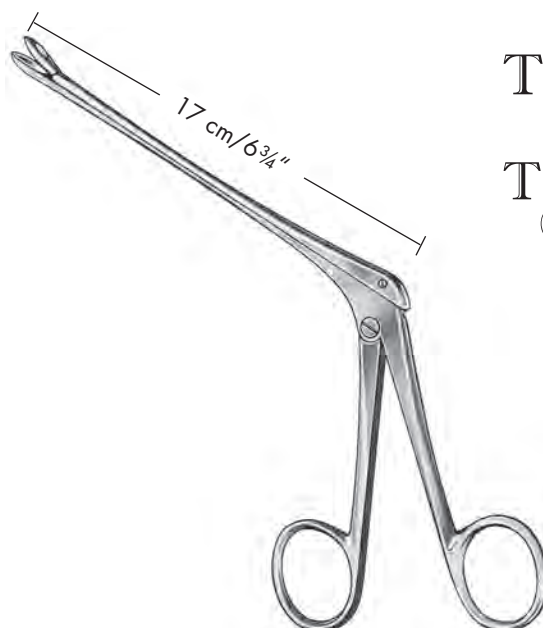





**SIEBBEINZANGEN
ETHMOIDAL FORCEPS**



TITAN

TITAN
CERAMED®

Weil-Blakesley

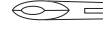
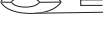
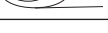
				
		gerade/straight	45° aufwärts gebogen 45° angled up	90° aufwärts gebogen 90° angled up
2,5 mm		RU 8090-10	RU 8091-10	RU 8092-10
3,0 mm		RU 8090-11	RU 8091-11	RU 8092-11
3,5 mm		RU 8090-12	RU 8091-12	RU 8092-12
TITAN				
2,5 mm		RU 8090-10 TI	RU 8091-10 TI	RU 8092-10 TI
3,0 mm		RU 8090-11 TI	RU 8091-11 TI	RU 8092-11 TI
3,5 mm		RU 8090-12 TI	RU 8091-12 TI	RU 8092-12 TI
TITAN CERAMED®				
2,5 mm		RU 8090-10 TI/CR	RU 8091-10 TI/CR	RU 8092-10 TI/CR
3,0 mm		RU 8090-11 TI/CR	RU 8091-11 TI/CR	RU 8092-11 TI/CR
3,5 mm		RU 8090-12 TI/CR	RU 8091-12 TI/CR	RU 8092-12 TI/CR

SIEBBEINZANGEN
ETHMOIDAL FORCEPS

Neu entwickelte Blakesley Siebbeinzangen mit verbessertem, modifiziertem, durchschneidendem Maul.
New developed Blakesley ethmoid forceps with improved, modified, intersecting jaw.

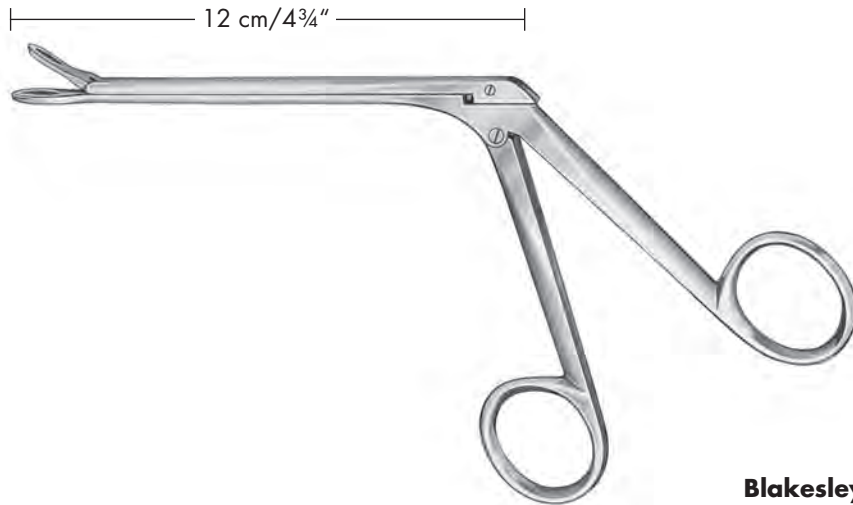

Blakesley-Rudolf



Größe Size	Maul gerade straight jaw	Maul aufgewinkelt jaw angled up	Maul nach links schneidend left cutting	Maul nach rechts schneidend right cutting
Fig. 0/2,5 mm	RU 8090-20	RU 8091-20		
Fig. 2/3,5 mm	RU 8090-22	RU 8091-22	RU 8090-22L	RU 8090-22R
Fig. 4/4,8 mm	RU 8090-24	RU 8091-24		



mit Absaugung – with suction



Mit Absaugung/with suction

Fig. 2/3,5 mm	RU 8090-22SU	RU 8091-22SU
---------------	---------------------	---------------------

MICRO-ZÄNGCHEN
MICRO-FORCEPS

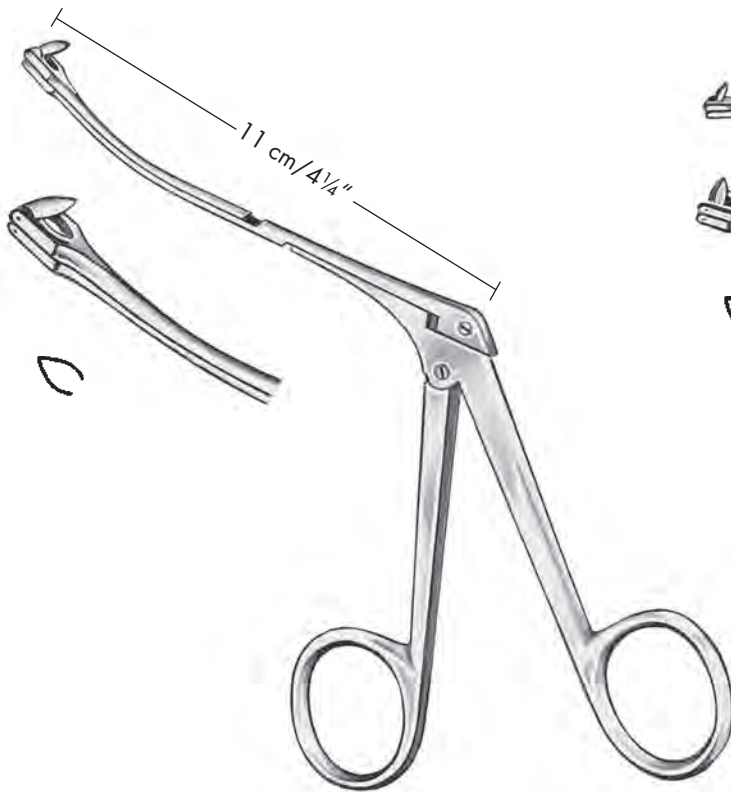

rückwärts schneidend/
retrograde cutting
aufgebogen/up-turned
2,5 mm 3,6 mm
RU 8096-02 RU 8096-03

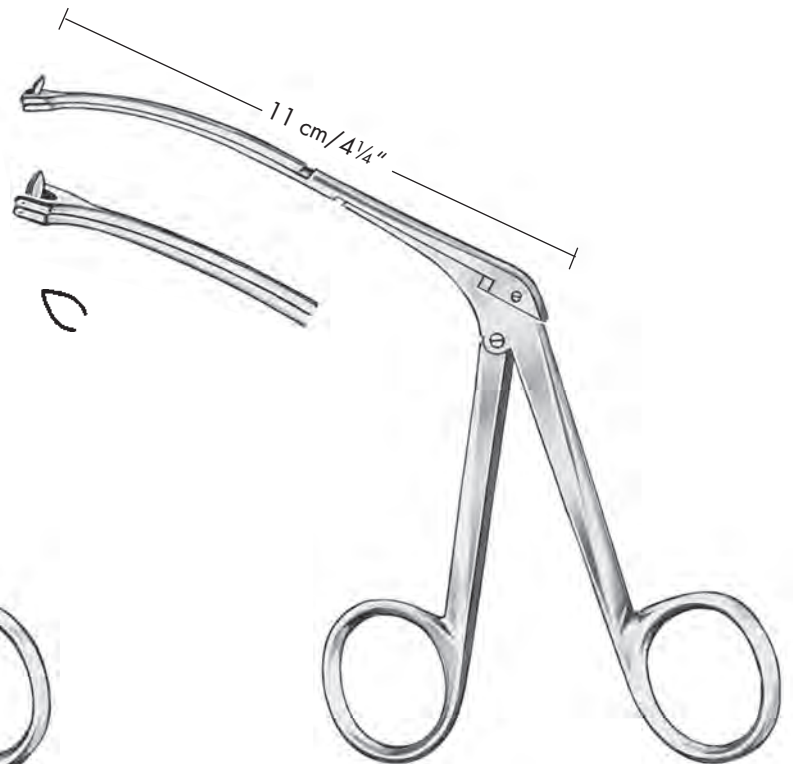





rückwärts schneidend/
retrograde cutting
abgebogen/down-turned
2,5 mm 3,6 mm
RU 8096-12 RU 8096-13



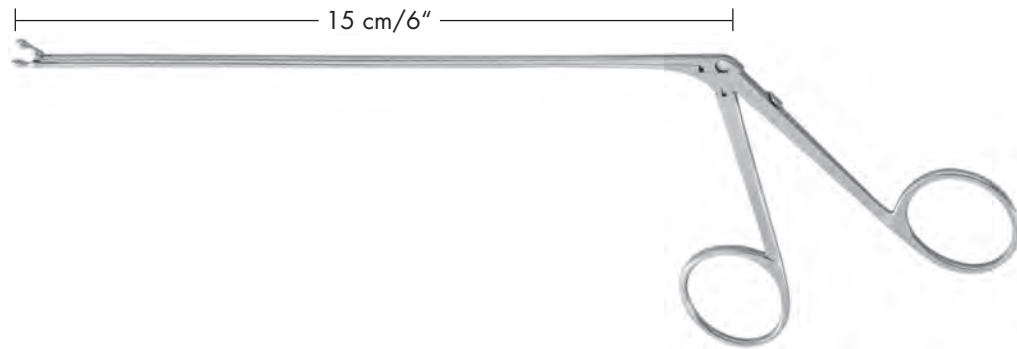



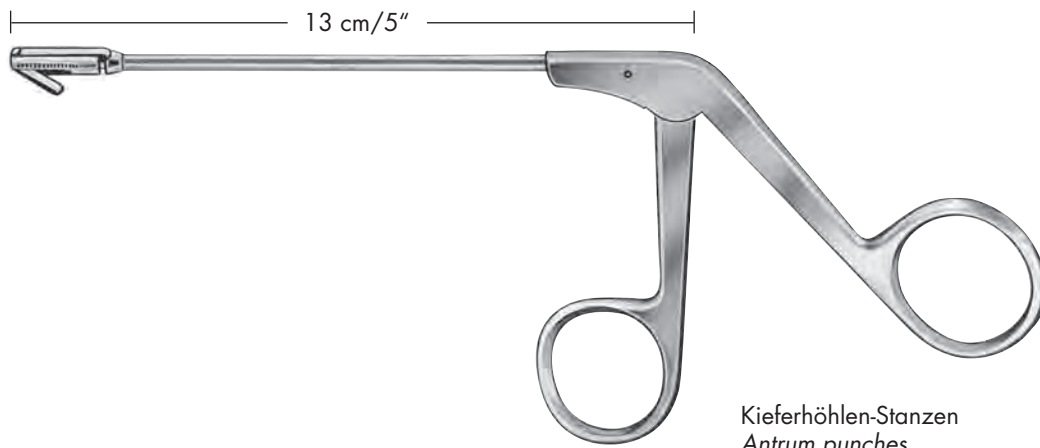

Ronis
RU 8093-01
Nasenrachen-Probeexcisionszange
Nasopharyngeal biopsy forceps

MICRO-ZÄNGCHEN UND -SCHEREN, KIEFERHÖHLEN-STANZEN
MICRO-FORCEPS AND -SCISSORS, ANTRUM PUNCHES



2,0 mm 	4,5 mm 	8,0 mm 	8,0 mm 
Löffelmaul <i>spoon shaped jaw</i>	Fasszange fein <i>grasping forceps fine</i>	Fasszange grob <i>grasping forceps coarse</i>	Schere <i>scissors</i>
RU 8111-01	RU 8111-02	RU 8111-03	RU 8111-04



	 2,5 mm x 6,5 mm	 2,0 mm x 5,0 mm
 nach oben schneidend <i>upwards cutting</i>	RU 8112-00	RU 8112-50
 nach rechts schneidend <i>right cutting</i>	RU 8112-01	RU 8112-51
 nach links schneidend <i>left cutting</i>	RU 8112-02	RU 8112-52
 nach unten schneidend <i>downwards cutting</i>	RU 8112-03	RU 8112-53

**KIEFERHÖHLEN-STANZEN, MICRO-STANZEN
ANTRUM PUNCHES, MICRO-PUNCHES**

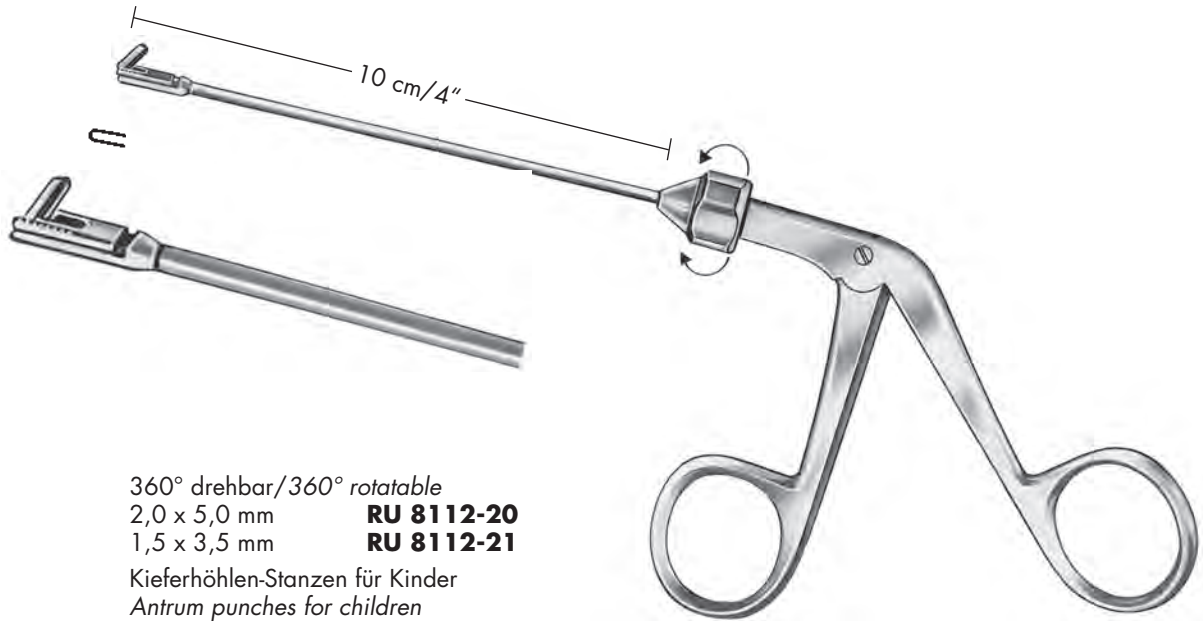

Mod. Rudolf

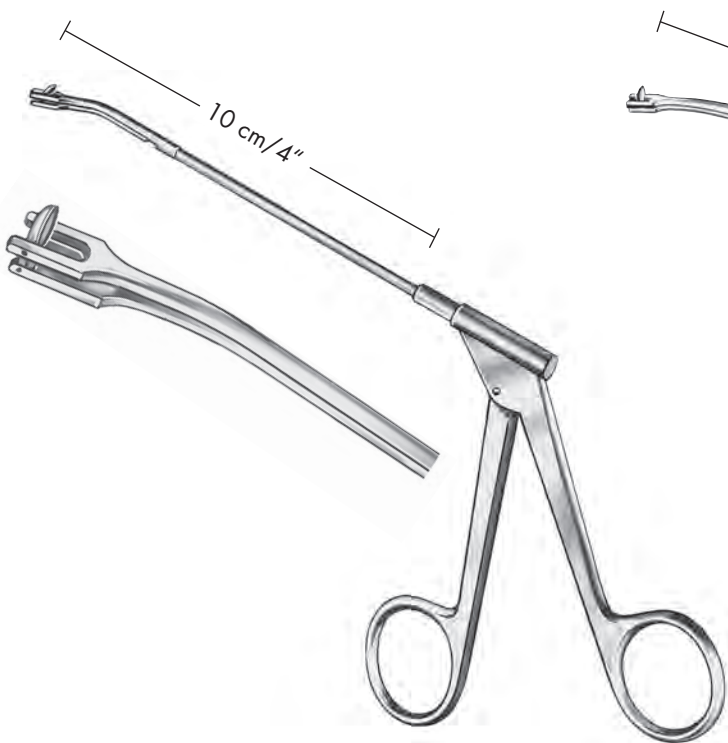

2 mm
abgewinkelt/angled up
RU 8112-60
Mikro-Stanze/
Micro-punch

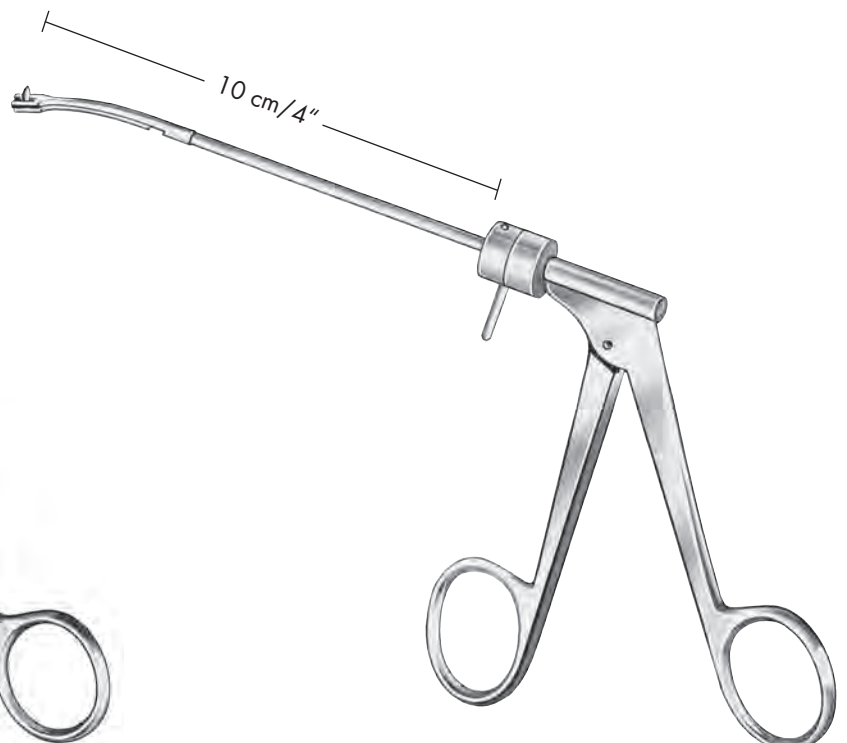

2 mm
abgewinkelt, rotierend
angled up, rotatable
RU 8112-61
Mikro-Stanze/
Micro-punch

ZIRKULAR-STANZEN
CIRCULAR CUTTING PUNCHES

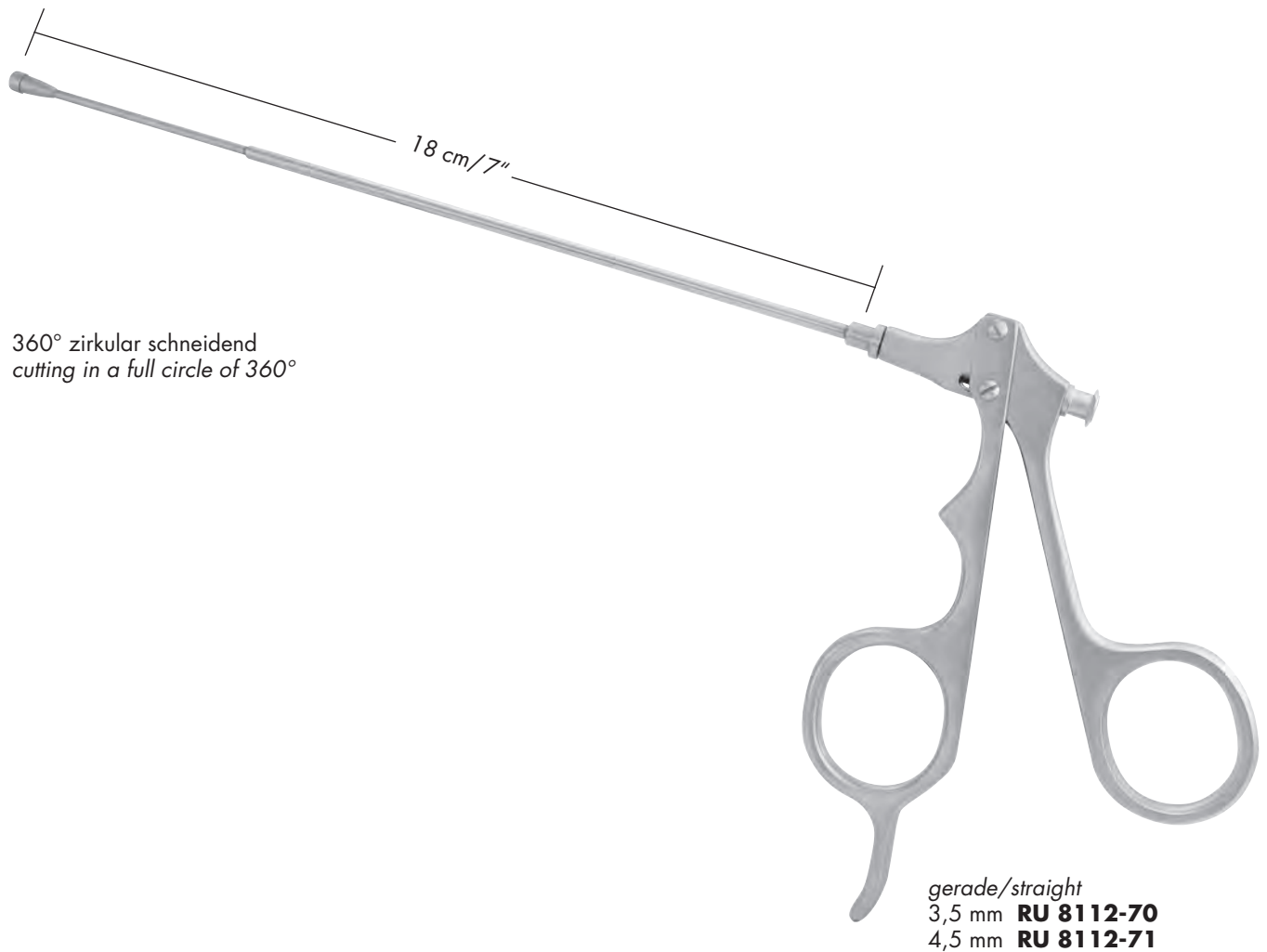

360° zirkular schneidend
cutting in a full circle of 360°

gerade/straight
3,5 mm **RU 8112-70**
4,5 mm **RU 8112-71**



aufgebogen/up-turned
3,5 mm **RU 8112-72**
4,5 mm **RU 8112-73**

FASSZANGE, NASENSTANZEN
GRASPING FORCEPS, NASAL PUNCHES

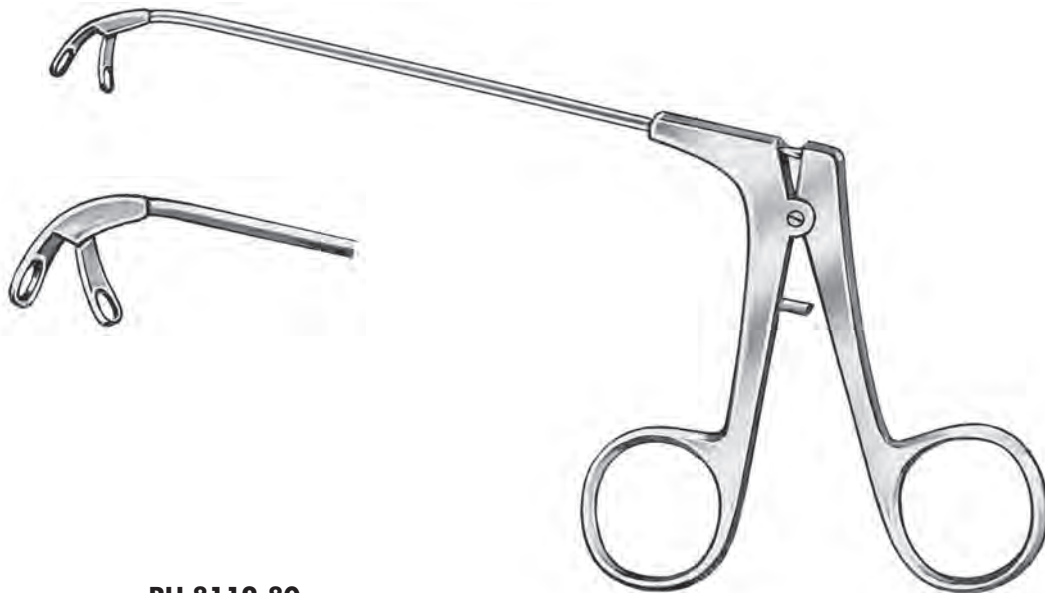

RU 8112-80

Kieferhöhlen-Faßzange zur Entfernung von Zysten und Polypen,
bewegliches Maulteil bis 120°, rückwärts öffnend, Nutzlänge 10 cm/4"
*Antrum grasping forceps, for endonasal removal
of cysts and polyps, retrograd opening jaws 120°, working length 10 cm/4"*

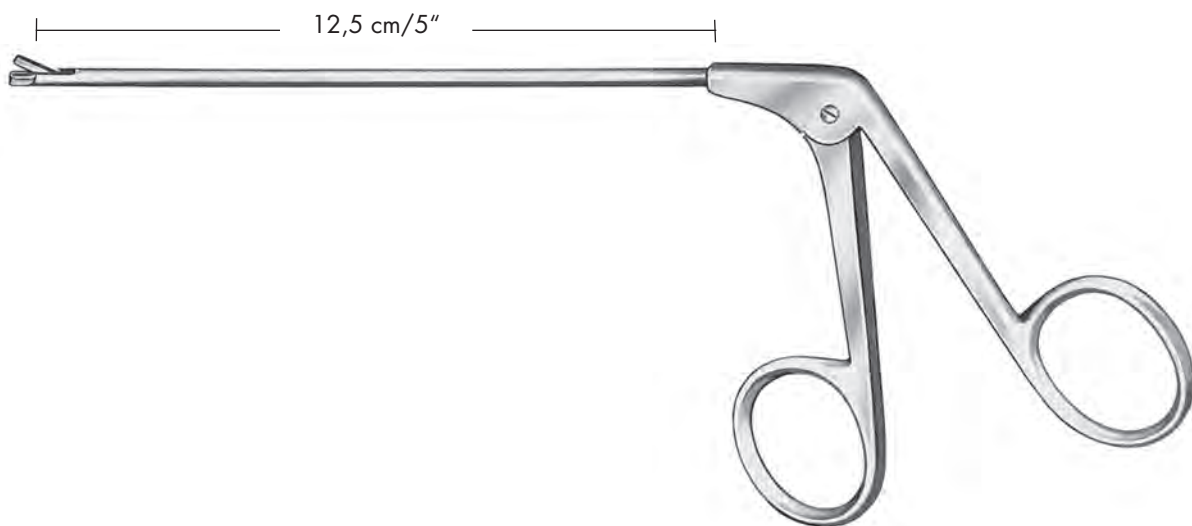

RU 8113-01 gerade/straight



RU 8113-02 45° aufwärts öffnend
backwards opening



RU 8113-03 45° abwärts öffnend
forwards opening

Nasensteinen
Nasal punches

DOPPELÖFFEL-ZANGEN
FORCEPS, CUPPED JAWS

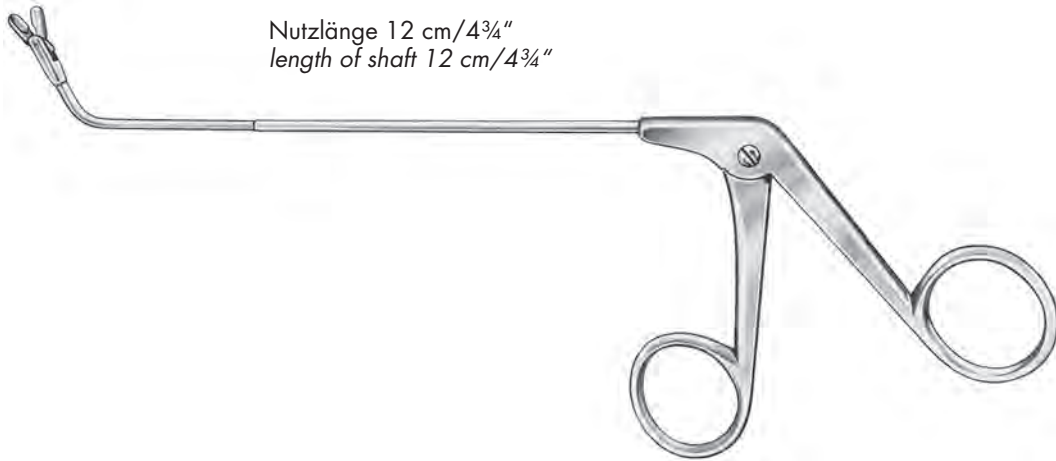

vertikal öffnend
vertical cutting

horizontal öffnend
horizontal cutting



70°

70°

4 mm **RU 8114-01**
3 mm **RU 8114-01/03**

4 mm **RU 8114-03**
3 mm **RU 8114-03/03**



90°

90°

4 mm **RU 8114-05**
3 mm **RU 8114-05/03**

4 mm **RU 8114-06**
3 mm **RU 8114-06/03**

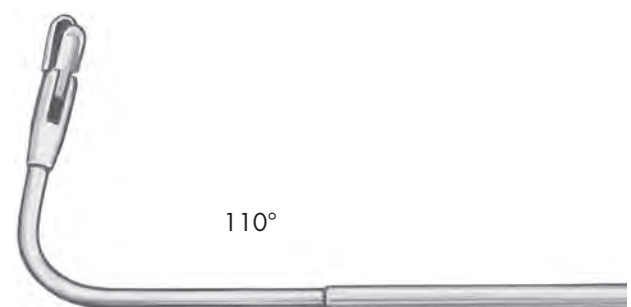

110°

110°

4 mm **RU 8114-02**
3 mm **RU 8114-02/03**

4 mm **RU 8114-04**
3 mm **RU 8114-04/03**

NASENSCHEREN, BIOPSIE- UND NASENRACHENZANGEN
NASAL SCISSORS, BIOPSY AND NASOPHARYNX FORCEPS

Nutzlänge 10 cm/4"
length of shaft 10 cm/4"



gerade
straight

RU 8115-00



rechts gebogen
curved right

RU 8115-01

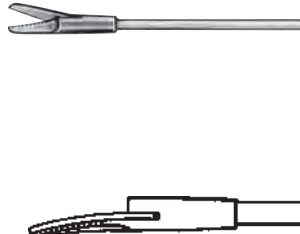

links gebogen
curved left

RU 8115-02



Nasenscheren/Nasal scissors

Nutzlänge 14 cm/5½"
length of shaft 14 cm/5½"



nach rechts öffnend
right side opening

RU 8116-01



nach links öffnend
left side opening

RU 8116-02

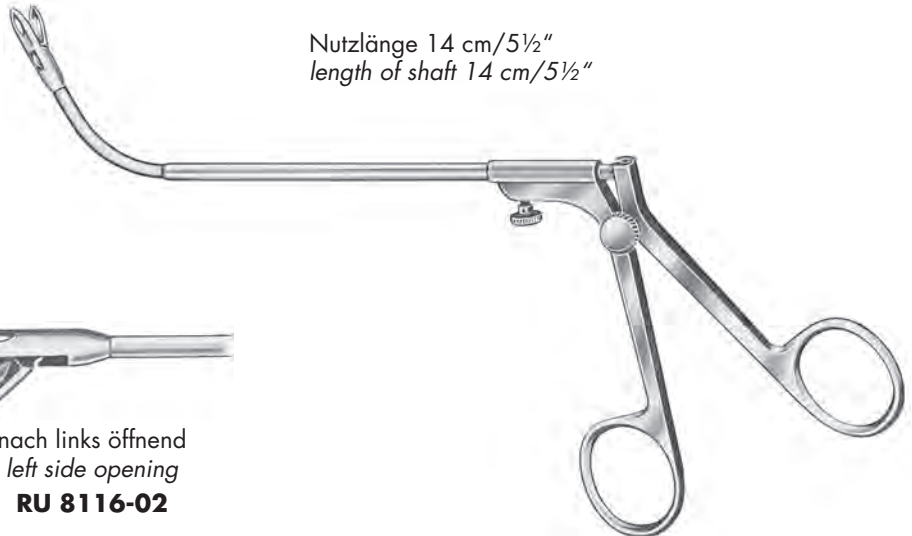

Biopsiezange für Nasenrachenraum und Hypopharynx, biegsam
Biopsy forceps for nasopharynx and hypopharynx, malleable

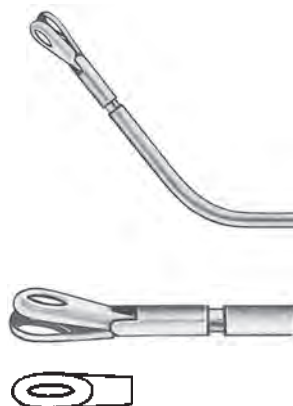

24 cm/9½"

RU 8117-24

Nasenrachenzange
Nasopharynx forceps



STIRNHÖHLENSTANZEN, PROBEEXCISIONS- UND FASSZANGEN
SINUS PUNCHES, BIOPSY FORCEPS, GRASPING FORCEPS

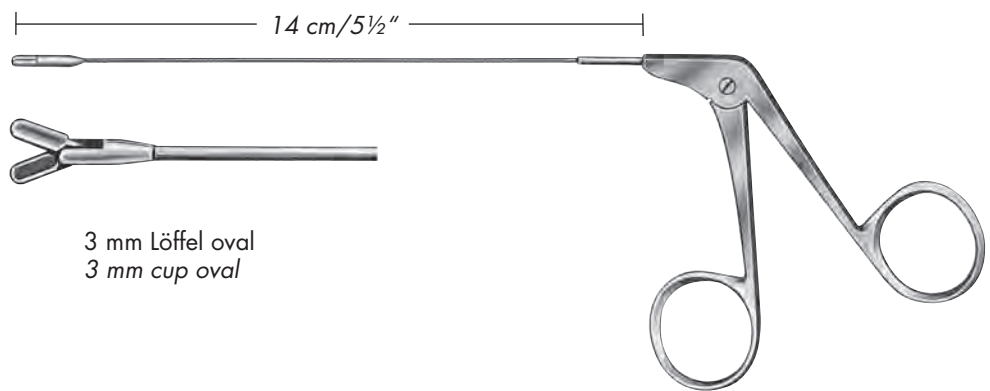
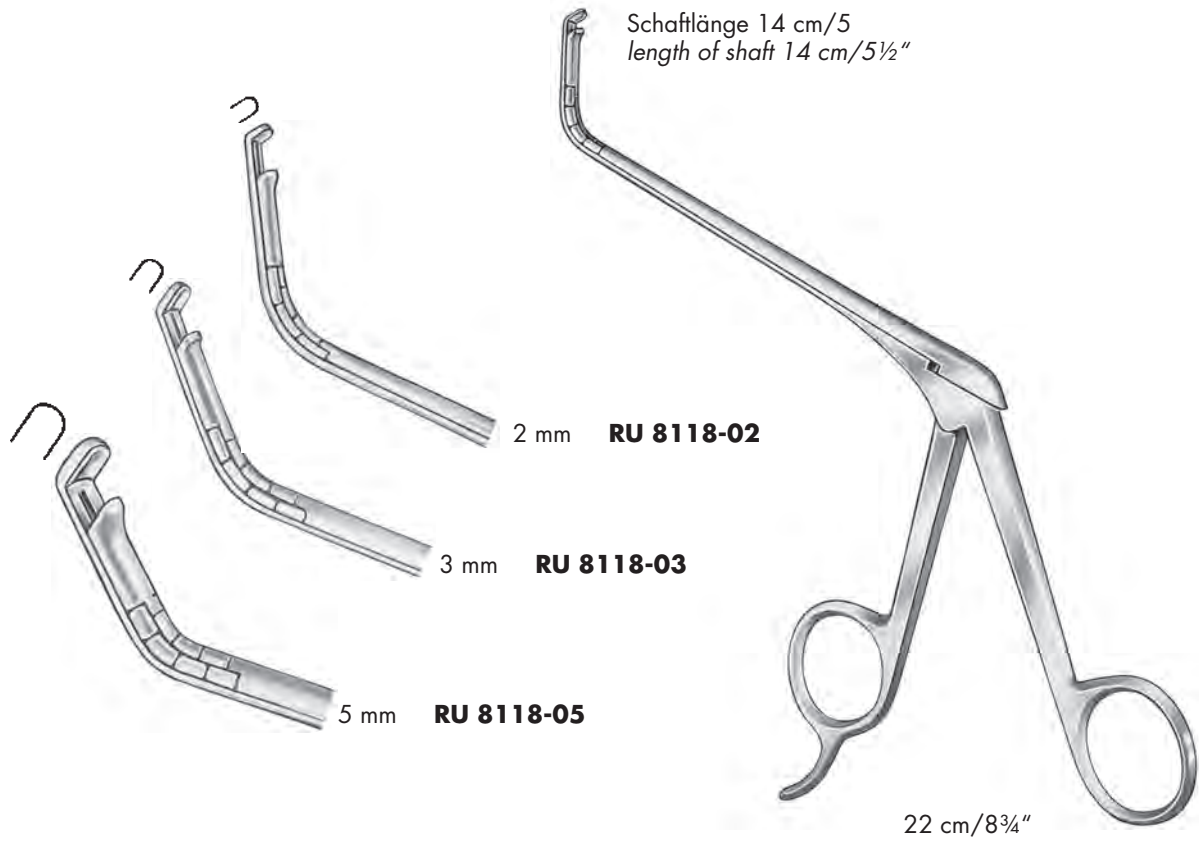

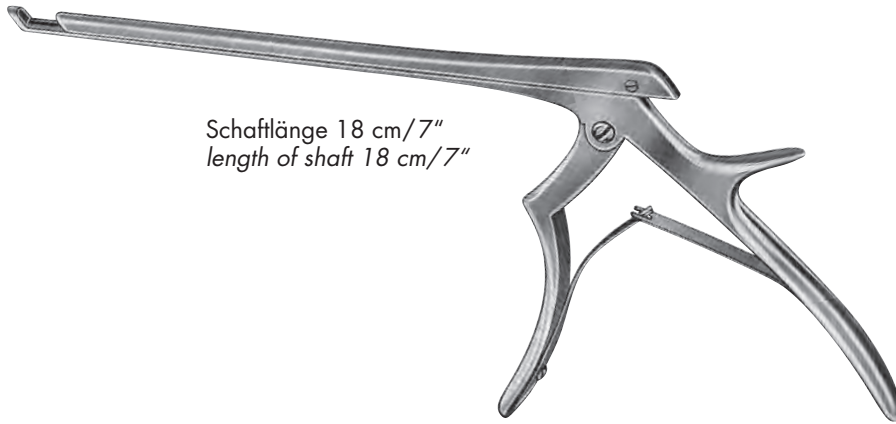

RU 8119-01
Probeexcisions- und Fasszange, extra fein
Biopsy and grasping forceps, extra fine

KIEFERHÖHLENSTANZEN
ANTRUM PUNCHES



Schafflänge 18 cm/7"
length of shaft 18 cm/7"

Ferris-Smith-Kerrison

Bissbreite width of bite	 aufwärts schneidend 90° upwards cutting 90°	 aufwärts schneidend 40° upwards cutting 40°	 abwärts schneidend 90° downwards cutting 90°
1 mm	RU 6456-01	RU 6457-01	RU 6458-01
2 mm	RU 6456-02	RU 6457-02	RU 6458-02
3 mm	RU 6456-03	RU 6457-03	RU 6458-03
4 mm	RU 6456-04	RU 6457-04	RU 6458-04
5 mm	RU 6456-05	RU 6457-05	RU 6458-05



Citelli

Bissbreite/ width of bite	1,0 mm	RU 7895-10
	2,0 mm	RU 7895-20
	3,0 mm	RU 7895-30



Citelli-Beyer

Bissbreite/width of bite 1,5 mm
RU 7896-15

ZERLEGBARE KNOCHENSTANZEN, PROCLEAN®
DETACHABLE BONE RONGEURS, PROCLEAN®

PROCLEAN® – für einfache, effiziente und optimale Reinigung

PROCLEAN® – for easy, efficient and optimum cleaning

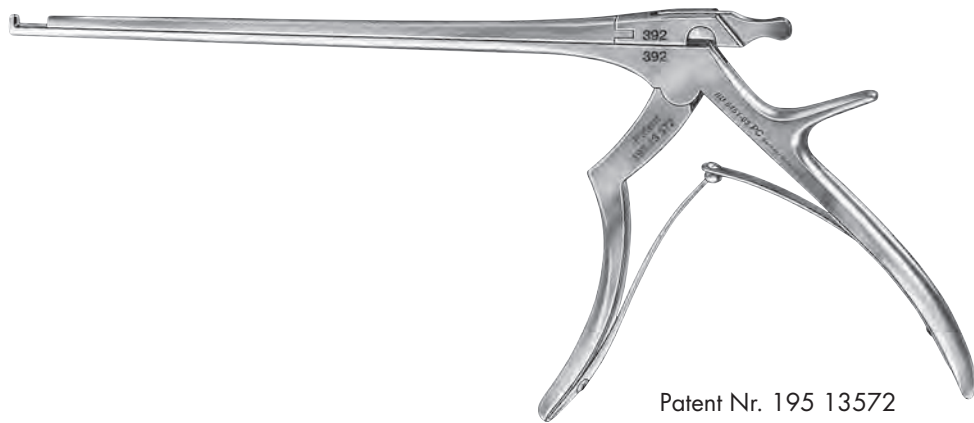

Patent Nr. 195 13572

Gründliche und einfache Reinigung

- Nur eine zerlegbare Stanze kann einfach und gründlich, gereinigt werden.
- Und nur eine sorgfältig gereinigte Stanze
 - garantiert gleichbleibende Beweglichkeit der Stanze
 - garantiert damit auch ein sicheres Gefühl für den Chirurgen
 - vermeidet viele Reparaturen
 - garantiert damit auch eine längere Lebensdauer

Eine Nummerncodierung erleichtert den Zusammenbau der zerlegten Stanzen.

Thorough and easy cleaning

- Only a detachable punch can be cleaned easily and thoroughly.
- And only a carefully cleaned punch
 - guarantees its constant mobility
 - therefore guarantees a safe feeling for the surgeon
 - avoids frequent repairs
 - finally guarantees a longer life of the instrument

The number code facilitates the reassembling of the detached punch.

90°



Schaftlänge Shaft length	Breite Width	
18 cm/7"	2 mm	RU 6456-52P
18 cm/7"	3 mm	RU 6456-53P
18 cm/7"	4 mm	RU 6456-54P
18 cm/7"	5 mm	RU 6456-55P

Stanzen mit Flachfuß, für spezielle Anwendungsbereiche, gekennzeichnet durch Vergoldung am distalen Ende

45°



Schaftlänge Shaft length	Breite Width	
18 cm/7"	2 mm	RU 6457-52P
18 cm/7"	3 mm	RU 6457-53P
18 cm/7"	4 mm	RU 6457-54P
18 cm/7"	5 mm	RU 6457-55P

Punches with flat nose for special applications, gold-plated at the distal end

SCHARFE LÖFFEL
SHARP CURETTES



RU 5357-01

Uffenorde
17 cm/6¾"



RU 5357-02



Fig. 1
RU 5362-01



Fig. 2
RU 5362-02

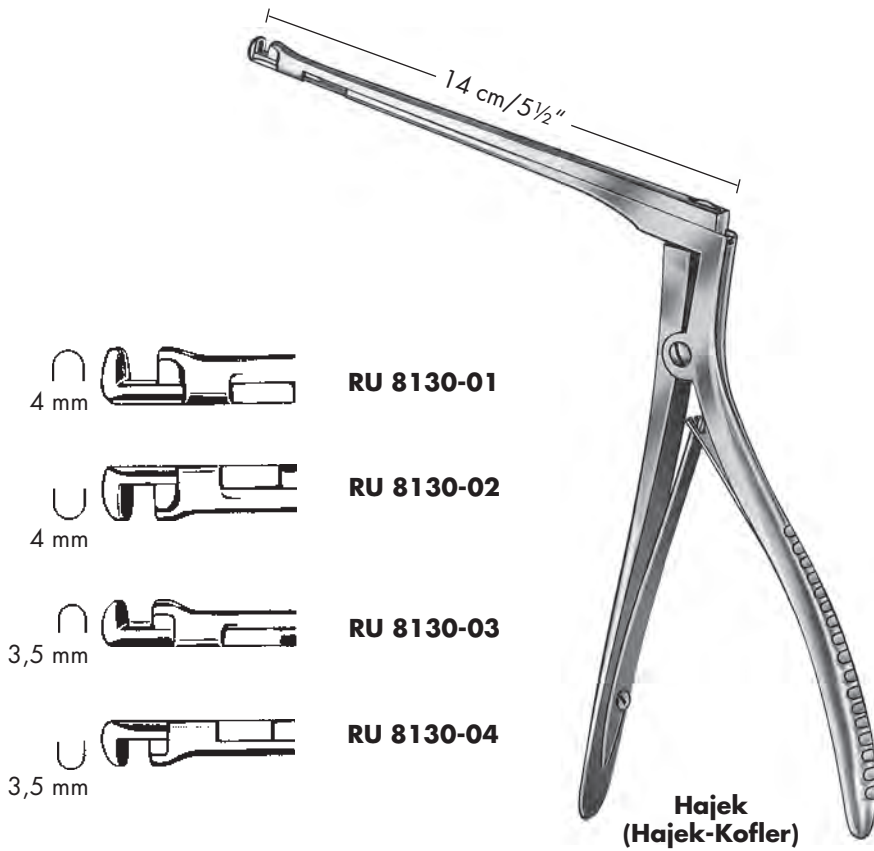

Fig. 3
RU 5362-03

Halle

21 cm/8¼"
biegsam/flexible

**KIEFERHÖHLENSTANZEN
ANTRUM PUNCHES**



**SICHELMESSER, KIEFERHÖHLEN-LÖFFEL
SICKLE KNIVES, ANTRUM CURETTES**



19 cm/7½"
Sichelmesser
Sickle knives



19 cm/7½"
Kieferhöhlen-Löffel
Antrum curettes



19 cm/7½"
Kieferhöhlen-Löffel
Antrum curettes

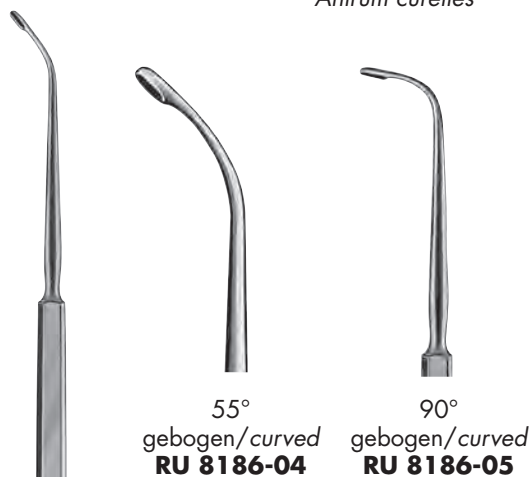

Kuhn-Bolger
19 cm/7½"



21 cm/8¼"
RU 8187-01

Doppelinstrument, gebogen,
abgewinkelter Haken an einem Ende
*Frontal sinus ostium seeker,
double-ended, curved*

KIEFERHÖHLENMEISSEL UND -RASPEL
ANTRUM CHISEL AND RASP



Faulkner
17 cm/6¾"
RU 8242-01
Kieferhöhlenmeißel
Antrum chisel



Wiener
19,5 cm/7¾"
RU 8269-12
Kieferhöhlenraspel
Antrum rasp

KIEFERHÖHLEN-ELEVATORIEN UND KÜRETTEN
ELEVATORS, ANTRUM CURETTES



Faulkner
21 cm/8¼"
RU 8334-21



Sewall
20 cm/8"
RU 8335-20
Elevatorium
Elevator



19 cm/7½"

vorwärts
schneidend
forwards
cutting

rückwärts
schneidend
backwards
cutting



RU 8338-01



RU 8338-02



RU 8338-03



RU 8338-04



Coakley
17 cm/6¾"



RU 8340-01



RU 8340-02



RU 8340-03



RU 8340-04



RU 8340-05



RU 8340-06

**KIEFER- UND STIRNHÖHLEN-SPÜLKANÜLEN
ANTRUM AND FRONTAL SINUS CANNULAS**



Van Alyea
15 cm/6"
Ø 2 mm
RU 8364-01



Van Alyea
12 cm/4¾"
Ø 1,5 mm
RU 8364-02

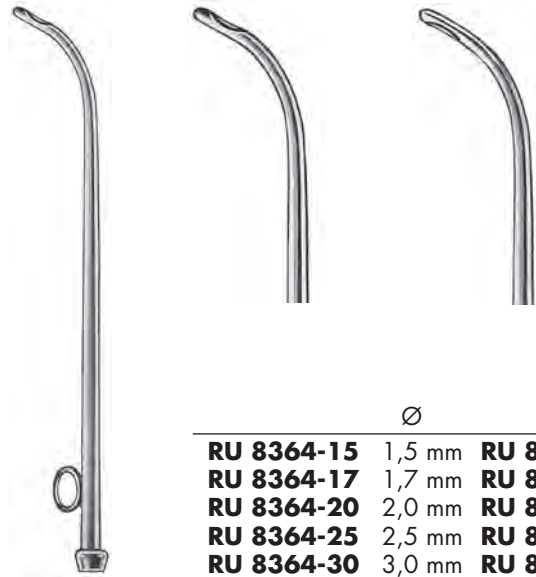

Siebenmann
15 cm/6"

	Ø	
RU 8364-15	1,5 mm	RU 8365-15
RU 8364-17	1,7 mm	RU 8365-17
RU 8364-20	2,0 mm	RU 8365-20
RU 8364-25	2,5 mm	RU 8365-25
RU 8364-30	3,0 mm	RU 8365-30

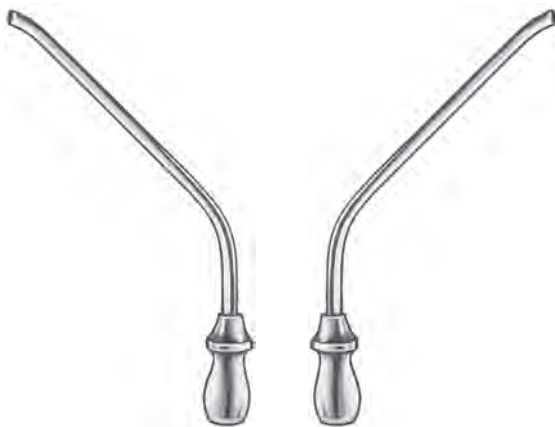

Hartmann
12 cm/4¾"
Ø

Fig. 1	Ø	Fig. 2
RU 8366-20	2,0 mm	RU 8367-20
RU 8366-25	2,5 mm	RU 8367-25
RU 8366-30	3,0 mm	RU 8367-30

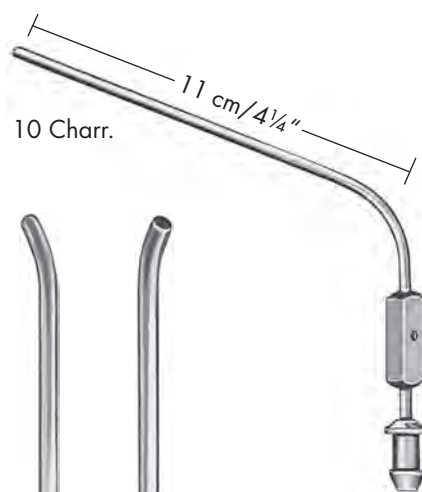

links left **RU 8366-00 L**
rechts right **RU 8366-00 R**
Rudert

**KANÜLEN, SONDEN
CANNULAS, DILATORS**



Eicken-Killian

Ø	14,5 cm/5½"
2,5 mm	RU-8368-00
3,0 mm	RU-8368-01
4,0 mm	RU-8368-02



Luer-Lock

Eicken

Ø	14,5 cm/5½"	
2,5 mm	RU-8368-12	RU-8368-22
3,0 mm	RU-8368-13	RU-8368-23
4,0 mm	RU-8368-14	RU-8368-24

Ø 2 mm



Killian

(Watson-Williams)
18 cm/7⅛"
biegsam/malleable
RU 8369-00



Ritter-Halle

16 cm/6¼"

2,5 mm	RU 8370-25
3,0 mm	RU 8370-30
4,0 mm	RU 8370-40
5,0 mm	RU 8370-50

Dilatationssonden
Frontal sinus dilators

SINUSKOPIE-TROKARE
SINUSCOPY TROCARS



Ø 1,8 mm **RU 5255-19**

Lichtwitz
19 cm/7½"

- Ø 2,5 mm **RU 8370-10**
- Ø 3,3 mm **RU 8370-11**
- Ø 4,0 mm **RU 8370-12**
- Ø 5,0 mm **RU 8370-01**



14 cm/5½"

Nutzlänge
working length
8,5 cm/3¾"

Ø 5 mm
RU 8370-02



14 cm/5½"

Nutzlänge 10 cm/4"
Working length 10 cm/4"



Lichtwitz



**Lichtwitz
v. Eicken**



Vogel

- | | | | |
|----------|-------------------|-------------------|-------------------|
| Ø 1,5 mm | RU 8372-01 | RU 8372-11 | RU 8372-21 |
| Ø 1,8 mm | RU 8372-02 | RU 8372-12 | RU 8372-22 |
| Ø 2,0 mm | RU 8372-03 | RU 8372-13 | RU 8372-23 |

Kieferhöhlenpunktionstrokare
Antrum puncture needles

**SPÜL- UND SAUGROHRE, SEPTUMKANÜLEN
WASH AND SUCTION CANNULAS, SEPTUM NEEDLES**

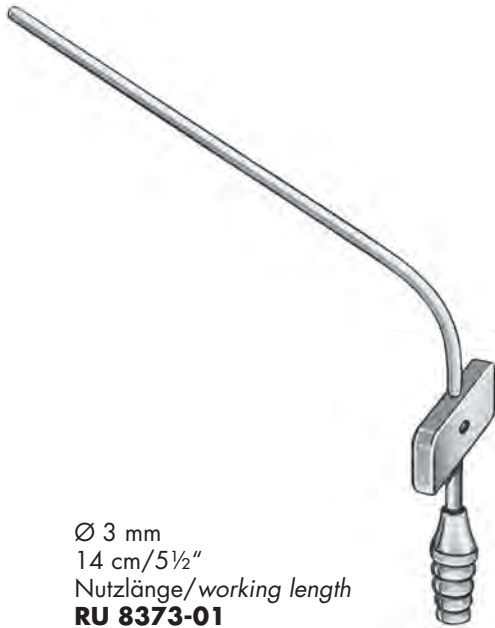

Ø 3 mm
14 cm/5½"
Nutzlänge/working length
RU 8373-01

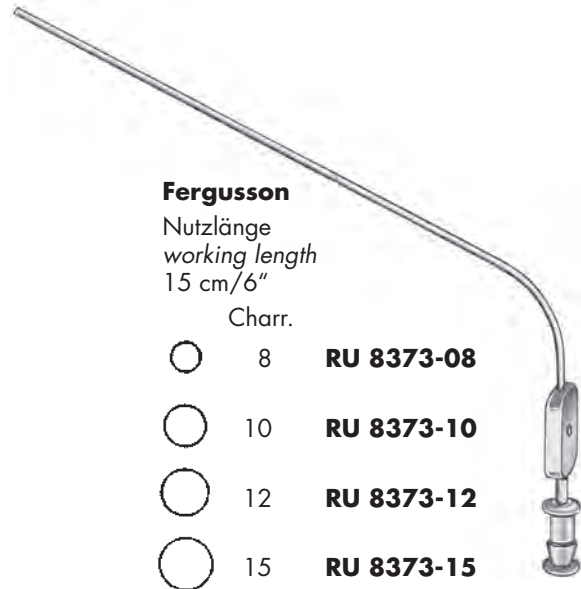

Fergusson

Nutzlänge
working length
15 cm/6"

Charr.

- 8 **RU 8373-08**
- 10 **RU 8373-10**
- 12 **RU 8373-12**
- 15 **RU 8373-15**

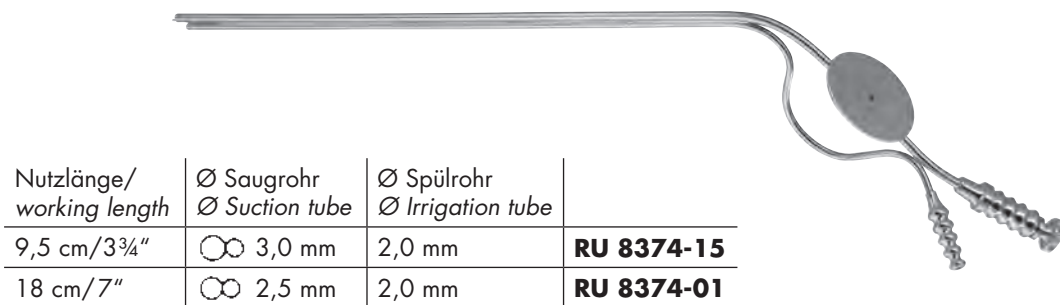

Nutzlänge/ working length	Ø Saugrohr Ø Suction tube	Ø Spülrohr Ø Irrigation tube	
9,5 cm/3¾"	3,0 mm	2,0 mm	RU 8374-15
18 cm/7"	2,5 mm	2,0 mm	RU 8374-01

Fisch

zylindrisch/cylindrical
Saug-/Spülrohr
suction/irrigation cannule

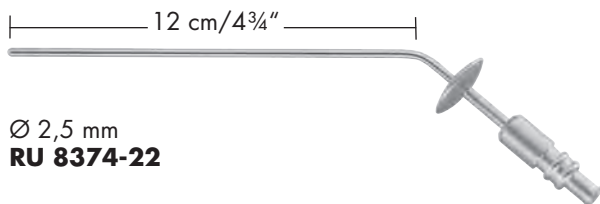

12 cm/4¾"

Ø 2,5 mm
RU 8374-22

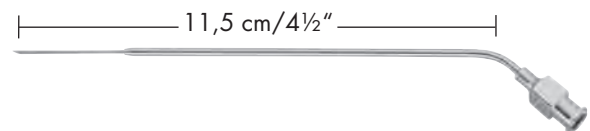

11,5 cm/4½"

Luer-Lock
Ø 0,8 mm
RU 8375-01
Septum-Kanüle
Septum needle

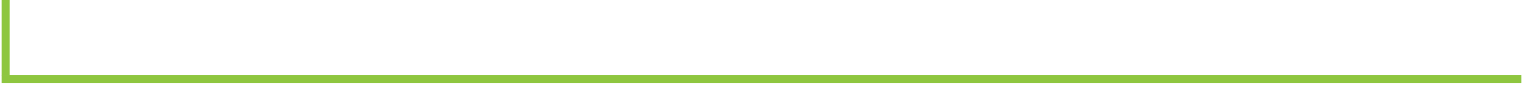

TRACHEOTOMIE

TRACHEOTOMY

Seiten 377 - 382

Pages 377 - 382

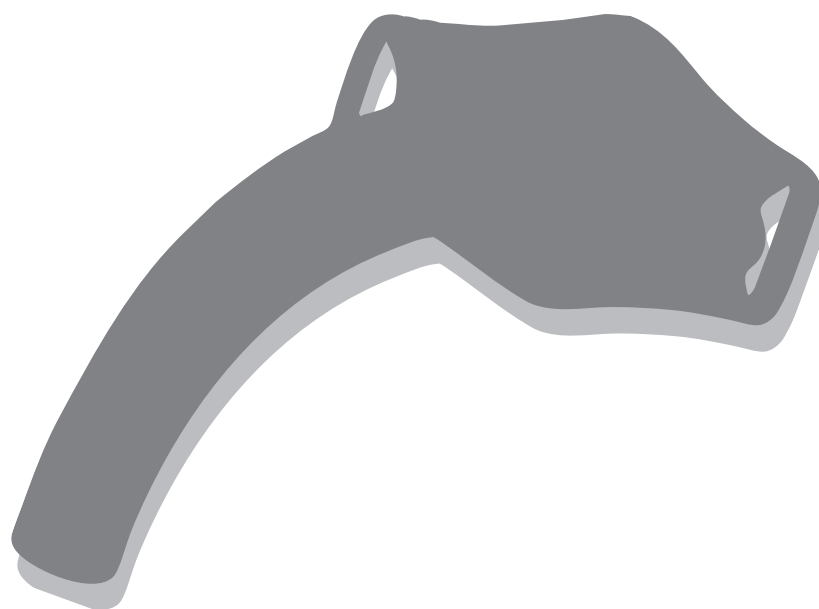

Übersicht

Intubationsrohre
Dilatatoren, Sperrer
Haken, Sonden

Overview

*Intubation tubes
Dilators, retractors
Hooks, probes*

Seiten / Pages

378
378
379

INTUBATIONSROHRE, TRACHEAL-DILATATOREN, SPERRER
INTUBATION TUBES, TRACHEA DILATORS, RETRACTORS



Brünings (Mosher)

21 cm/8¼"
 Ø 5 mm **RU 6249-05**
 Ø 7 mm **RU 6249-07**
 Ø 9 mm **RU 6249-09**

Intubationsrohre
 Intubation tubes

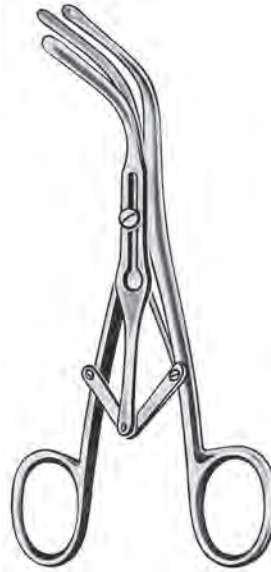

Laborde
 15 cm/6" **RU 6250-15**



Trousseau
 14 cm/5½"
RU 6251-14



Trousseau-Baby
 13 cm/5"
RU 6252-13



Bose
 7 cm/2¾"
RU 6253-07

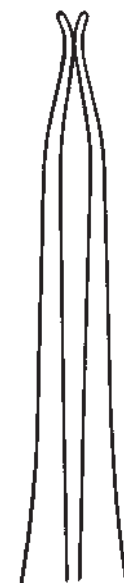

Weerda
 19 cm/7½"
RU 6254-19

TRACHEALHAKEN, -TROKARE, SCHILDDRÜSENHAKEN, SONDEN
TRACHEA HOOKS AND TROCARS, THYROID GLAND RETRACTORS, PROBES

links/left
für rechte Hand/
for right hand
RU 6255-01

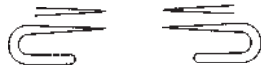

Bose
16 cm/6¼"
scharf/sharp



rechts/right
für linke Hand
for left hand
RU 6255-02



Schoenborn
21 cm/8¼"
RU 6257-21



Uckermann
13 cm/5"
Ø 8 mm **RU 6259-08**
Ø 10 mm **RU 6259-10**



Kocher
15 cm/6" **RU 6277-15**
16 cm/6¼" **RU 6277-16**



Bei dieser Katalog-Auflage handelt es sich um einen Nachdruck mit geringfügigen Änderungen; daher entfällt der ursprüngliche Inhalt auf dieser Seite.

This catalogue edition is a reprint with minor amendments. This is why the initial content of this page has been removed.



Bei dieser Katalog-Auflage handelt es sich um einen Nachdruck mit geringfügigen Änderungen; daher entfällt der ursprüngliche Inhalt auf dieser Seite.

This catalogue edition is a reprint with minor amendments. This is why the initial content of this page has been removed.

TRACHEOTOMIE-BESTECK
TRACHEOTOMY SET



Oropharyngealtubus

Weichgummi
rot, wiederaufbereitbar

Rubber airway
red, reusable

Größe	mm		
000	9,0 x	31,0	RU 6272-30
00	10,0 x	38,0	RU 6272-20
0	13,5 x	54,5	RU 6272-10
1	13,5 x	62,3	RU 6272-01
2	16,0 x	67,0	RU 6272-02
3	18,0 x	82,0	RU 6272-03
4	22,0 x	93,7	RU 6272-04
5	21,0 x	99,0	RU 6272-05
6	22,0 x	118,7	RU 6272-06

LARYNGOLOGIE

ENDOLARYNGEALE MIKROCHIRURGIE

LARYNGOLOGY

ENDOLARYNGEAL MICROSURGERY

Seiten 383 - 412

Pages 383 - 412

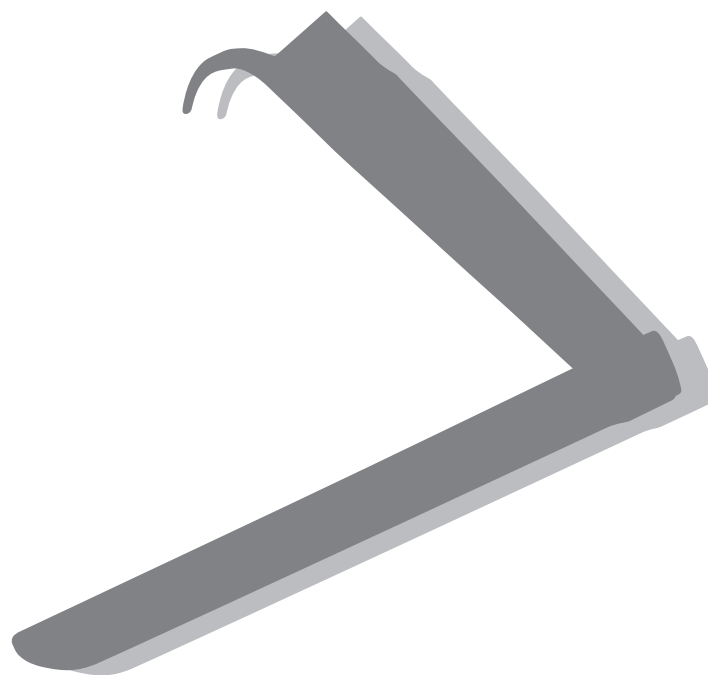

Übersicht

Laryngoskopgriffe, Zubehör
Laryngoskope
Kaltlicht-Laryngoskope
Operationslaryngoskope, Bruststütze
Lichtträger, Kanülen, Saugrohre
Zangen, Zangenaufsätze
Laryngoskopie-Instrumente
Watteträger
Griffe, Verlängerungsrohre
Spiegel, Griffe
Kehledeckelhalter, Zangen, Scheren

Overview

Handles for laryngoscopes, accessories
Laryngoscopes
Fiber Optic laryngoscopes
Operation laryngoscopes, chest support
Light guide, drain-, suction tubes
Forceps, forceps tips
Laryngoscopyinstruments
Cotton applicators
Handles, tubes
Mirrors, Handles
Epiglottis retractors, forceps scissors

Seiten / Pages

384
385-388
389-391
392-395
394
396-401, 407, 408, 410, 411
402-404
405
407
409
410-411

**GRIFFE FÜR LARYNGOSKOPE
HANDLES FOR LARYNGOSCOPES**

ohne Batterien/*without batteries*



Ø 30 mm
RU 5180-10

mit Trafoanschluss
with transformer connection
RU 5180-10/01



Ø 30 mm
RU 5180-11



Ø 18 mm
RU 5185-10

Batteriegriffe, für konventionelle Batterien/*Battery handles, for conventional batteries*



für Spatel Fig. 0 – 1
for blades Fig. 0 to 1

RU 5180-08



für Spatel Fig. 2 – 5
for blades Fig. 2 to 5

RU 5180-09

Ersatzlämpchen/*Spare bulb*



RU 5180-12

NC-Akku
aufladbar über Transformator
*NC-Accumulator
rechargeable by transformer*



220 V **RU 5180-13**
110 V **RU 5180-14**
Transformator
Transformer

Trafo 220 Volt mit 1,4 m langem Kabel.
Trafo 110 Volt mit amerikanischem Netzanschluß.
Bei eventuellem Fehlen oder Ausfallen von Batterien
und Akkus direkter Netzanschluß über Trafo möglich.

*Transformer 220 Volt with 1.4 m cable. Transformer
110 Volt with american mains adapter. If batteries
and rechargeable batteries are not available or out
of order, direct mains connection via transformer is
possible.*



Laryngoskopie-Spatel nach McIntosh
McIntosh Laryngoscope Blades

Fig.	Nutzlänge working length	Gesamtlänge length	
0	53 mm	75 mm	RU 5180-00
1	68 mm	90 mm	RU 5180-01
2	88 mm	110 mm	RU 5180-02
3	108 mm	130 mm	RU 5180-03
4	128 mm	150 mm	RU 5180-04
5	148 mm	170 mm	RU 5180-05

RU 5180-30 Satz in Etui, mit 3 Spateln,
bestehend aus:

*Set in case, with 3 blades,
consisting of:*

RU 5180-10
RU 5180-01
RU 5180-02
RU 5180-03
RU 5180-99 Etui/case

RU 5180-40 Satz in Etui, mit 4 Spateln,
bestehend aus:

*Set in case, with 4 blades,
consisting of:*

RU 5180-10
RU 5180-01
RU 5180-02
RU 5180-03
RU 5180-04
RU 5180-99 Etui/case

RU 5180-42 Satz in Etui, mit 3 Spateln,
bestehend aus:

*Set in case, with 3 blades,
consisting of:*

RU 5180-10
RU 5180-00
RU 5180-01
RU 5180-02
RU 5180-99 Etui/case



McIntosh

**LARYNGOSKOPE
LARYNGOSCOPES**



**Laryngoskopie-Spatel nach Wisconsin-Foregger
Wisconsin-Foregger Laryngoscope Blades**

Fig.	Nutzlänge working length	Gesamtlänge length	
0	70 mm	92 mm	RU 5182-00
1	93 mm	115 mm	RU 5182-01
2	108 mm	130 mm	RU 5182-02
3	138 mm	160 mm	RU 5182-03
4	168 mm	190 mm	RU 5182-04



RU 5182-31 Satz in Etui, mit 3 Spateln,
bestehend aus:

*Set in case, with 3 blades,
consisting of:*

- RU 5180-10**
- RU 5182-01**
- RU 5182-02**
- RU 5182-03**
- RU 5182-99** Etui/case

Wisconsin-Foregger



Laryngoskopie-Spatel nach Negus
Negus Laryngoscope Blades

Fig.	Nutzlänge working length	Gesamtlänge length	
1	73 mm	95 mm	RU 5184-01
2	88 mm	110 mm	RU 5184-02
3	108 mm	130 mm	RU 5184-03
4	138 mm	160 mm	RU 5184-04



Negus

RU 5184-20 Satz in Etui, mit 2 Spateln,
bestehend aus:

*Set in case, with 2 blades,
consisting of:*

RU 5185-10
RU 5184-01
RU 5184-03
RU 5180-99 Etui/case

**LARYNGOSKOPE
LARYNGOSCOPES**



**Laryngoskopie-Spatel nach Miller
Miller Laryngoscope Blades**

Fig.	Nutzlänge working length	Gesamtlänge length	
0	53 mm	75 mm	RU 5185-00
1	78 mm	100 mm	RU 5185-01
2	133 mm	155 mm	RU 5185-02
3	173 mm	195 mm	RU 5185-03
4	183 mm	205 mm	RU 5185-04



RU 5185-30 Satz in Etui, mit 3 Spateln,
bestehend aus:

*Set in case, with 3 blades,
consisting of:*

RU 5180-10
RU 5185-02
RU 5185-03
RU 5185-04
RU 5185-99 Etui/case

RU 5185-40 Satz in Etui, mit 4 Spateln,
bestehend aus:

*Set in case, with 4 blades,
consisting of:*

RU 5180-10
RU 5185-01
RU 5185-02
RU 5185-03
RU 5185-04
RU 5185-99 Etui/case

Miller

**KALTLICHT-LARYNGOSKOPE MIT HALOGEN UND FIBER-OPTIK
LARYNGOSCOPES WITH HALOGEN AND FIBER OPTICS ILLUMINATION**

ohne Batterien/*without batteries*



mit Trafoanschluss
with transformer connection

RU 5188-10/01
für NC-Akku RU 5180-12 und
Transformator 220 V, RU 5180-13
bzw. 110 V RU 5180-14, siehe Seite 384

*for NC rechargeable battery RU 5180-12
and transformer 220 V, RU 5180-13
resp. 110 V RU 5180-14, see page 384*

Ø 30 mm
RU 5188-10

Batteriegriff für
konventionelle Batterien
*Battery handle for
conventional batteries*



Ø 18 mm
RU 5188-12

Batteriegriff für
konventionelle Batterien
*Battery handle for
conventional batteries*



McIntosh Fiber-Optics

**Laryngoskopie-Spatel nach McIntosh
McIntosh Laryngoscope Blades**

Fig.	Nutzlänge <i>Working length</i>	Gesamtlänge <i>Length</i>	
0	53 mm	75 mm	RU 5188-00
1	68 mm	90 mm	RU 5188-01
2	88 mm	110 mm	RU 5188-02
3	108 mm	130 mm	RU 5188-03
4	128 mm	150 mm	RU 5188-04



Halogenlampe 2,5 V
Halogen lamp 2.5 V

RU 5188-08

KALTLICHT-LARYNGOSKOPE MIT HALOGEN UND FIBER-OPTIK
LARYNGOSCOPES WITH HALOGEN AND FIBER OPTICS ILLUMINATION



McIntosh Fiber-Optics

RU 5188-30 Satz in Etui, mit 3 Spateln,
bestehend aus:

*Set in case, with 3 blades,
consisting of:*

RU 5188-10
RU 5188-02
RU 5188-03
RU 5188-04
RU 5180-99 Etui/case

RU 5188-40 Satz in Etui, mit 4 Spateln,
bestehend aus:

*Set in case, with 4 blades,
consisting of:*

RU 5188-10
RU 5188-01
RU 5188-02
RU 5188-03
RU 5188-04
RU 5180-99 Etui/case

**KALTLICHT-LARYNGOSKOPE MIT HALOGEN UND FIBER-OPTIK
LARYNGOSCOPES WITH HALOGEN AND FIBER OPTICS ILLUMINATION**



Miller Fiber-Optic

**Laryngoskopie-Spatel nach Miller
Miller Laryngoscope Blades**

Fig.	Nutzlänge working length	Gesamtlänge length	
0	53 mm	75 mm	RU 5189-00
1	78 mm	100 mm	RU 5189-01
2	133 mm	155 mm	RU 5189-02
3	173 mm	195 mm	RU 5189-03
4	183 mm	205 mm	RU 5189-04



Miller Fiber-Optics

RU 5189-30 Satz in Etui, mit 3 Spateln, bestehend aus:

Set in case, with 3 blades, consisting of:

RU 5188-10
RU 5189-02
RU 5189-03
RU 5189-04
RU 5185-99 Etui/case

RU 5189-40 Satz in Etui, mit 4 Spateln, bestehend aus:

Set in case, with 4 blades, consisting of:

RU 5188-10
RU 5189-01
RU 5189-02
RU 5189-03
RU 5189-04
RU 5185-99 Etui/case

RU 5189-50 Satz in Etui, mit 5 Spateln, bestehend aus:

Set in case, with 5 blades, consisting of:

RU 5188-10
RU 5189-00
RU 5189-01
RU 5189-02
RU 5189-03
RU 5189-04
RU 5185-99 Etui/case

BRUSTSTÜTZE, OPERATIONS-LARYNGOSKOPE
CHEST-SUPPORT, OPERATION LARYNGOSCOPES



Bruststütze für Erwachsene, komplett mit Stützstange, 34 cm/13½"
Chest support for adults, complete with support rod, 34 cm/13½"

RU 5170-01

Stützstange für Kinder, 24 cm/9½"
Chest support for children, 24 cm/9½"

RU 5170-02

Stützstange für Erwachsene, 34 cm/13½"
Chest support for adults, 34 cm/13½"

RU 5170-03

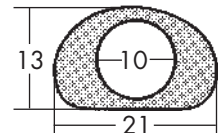
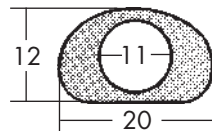

rostfreier Edelstahl
Rohr – innen matt,
 außen glänzend
Griff – ganz matt
stainless steel
tube – inner surface matt
 outer surface polished
handle – matt

Fig. 1



RU 5170-11

Fig. 2



RU 5170-12

**OPERATIONSLARYNGOSKOPE
OPERATION LARYNGOSCOPES**

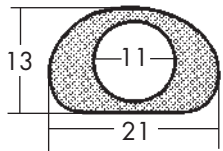
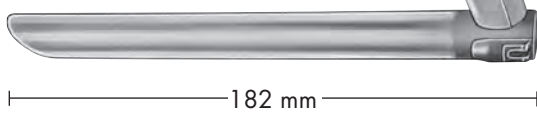

Fig. 3

rostfreier Edelstahl.
Rohr – innen matt,
außen glänzend
Griff – ganz matt

stainless steel
tube – inner surface matt
outer surface polished
handle – matt



RU 5170-13

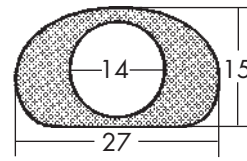
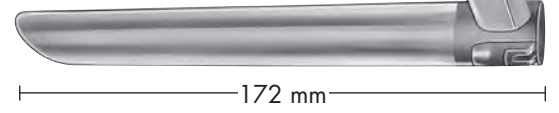

Fig. 4



RU 5170-14

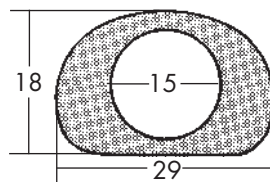
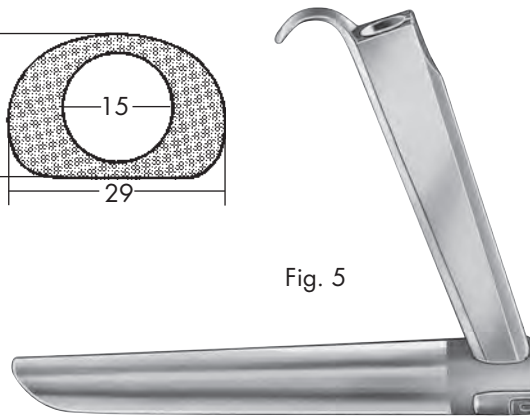

Fig. 5



RU 5170-15

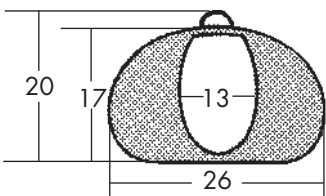
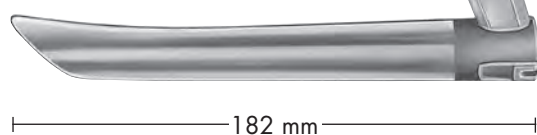

Fig. 6



RU 5170-16

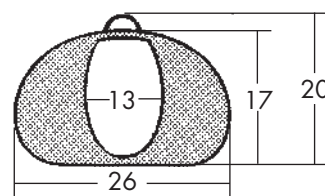
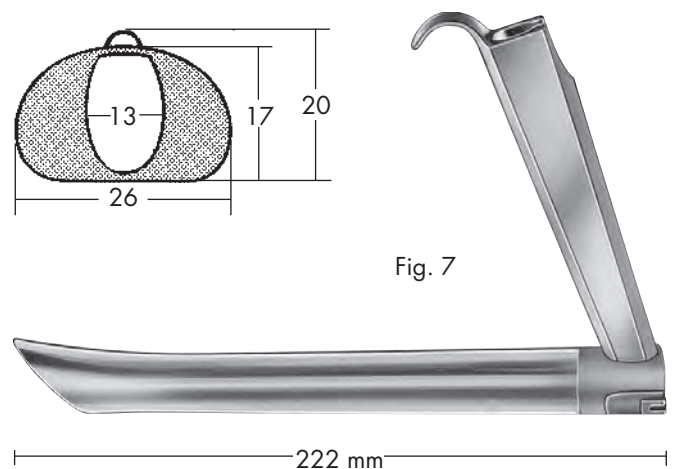

Fig. 7



RU 5170-17

**LARYNGOSKOPE, ZUBEHÖR
LARYNGOSCOPES, ACCESSORIES**



für/for Fig. 1 und Fig. 2

RU 5170-23



für/for Fig. 3 bis Fig. 6

RU 5170-24



für/for Fig. 7

RU 5170-25

Fiberglas-Lichtträger für Laryngoskope
Fiberglass light guide for laryngoscopes



für/for Fig. 1 bis Fig. 7

RU 5170-31

Injektionskanüle für Laryngoskope
Injection drain tube for laryngoscopes

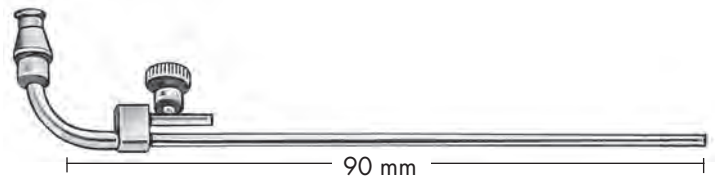

für/for Fig. 3 bis Fig. 7

RU 5170-33

Rauchabsaugrohr für Laryngoskope
Suction tube for laryngoscopes

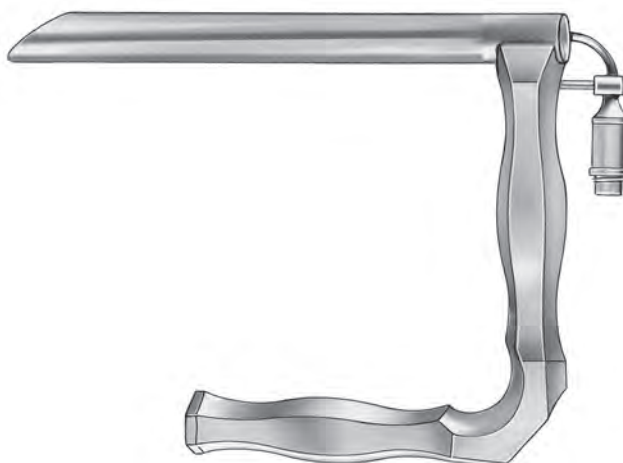
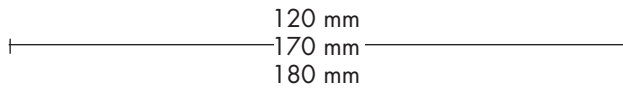

Jackson
Laryngoskope
Laryngoscopes

für Erwachsene/*for adults* 180 mm **RU 5178-01**
für Kinder/*for children* 170 mm **RU 5178-02**
für Säuglinge/*for babies* 120 mm **RU 5178-03**

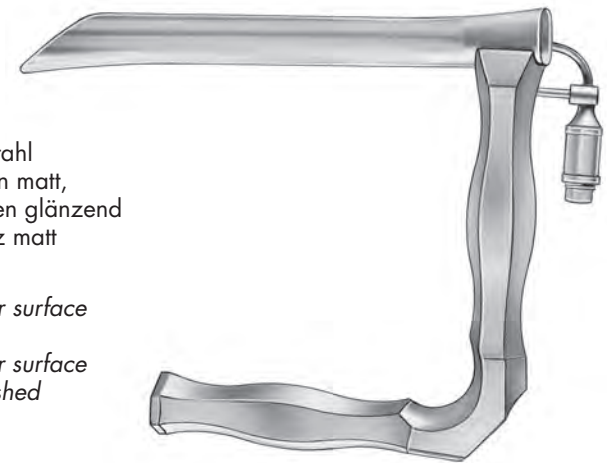
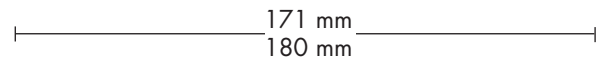

rostfreier Edelstahl
Rohr – innen matt,
 außen glänzend
Griff – ganz matt
stainless steel
tube – inner surface
 matt
 outer surface
 polished
handle – matt

Holinger
Laryngoskope
Laryngoscope

180 mm **RU 5178-11**
171 mm **RU 5178-12**

OPERATIONSLARYNGOSKOPE, SPREIZBAR
OPERATION LARYNGOSCOPES, SPREADABLE

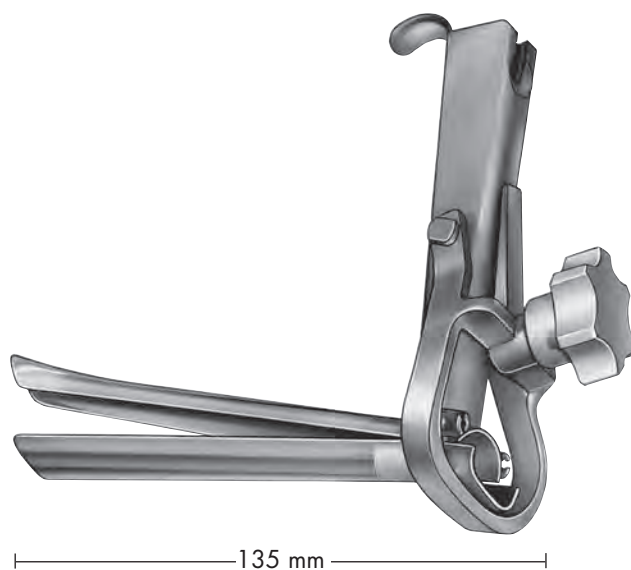

rostfreier Edelstahl
Rohr – innen matt,
 außen glänzend
Griff – ganz matt
stainless steel
tube – inner surface matt
 outer surface polished
handle – matt

Spreizbar/Spreadable

Länge Length	Außendurchmesser Outer diameter	Innendurchmesser Inner diameter	
135 mm	20 x 12 mm	Ø 11 mm	RU-5171-11
152 mm	21 x 13 mm	Ø 10 mm	RU-5171-12
182 mm	21 x 13 mm	Ø 11 mm	RU-5171-13
172 mm	27 x 15 mm	Ø 14 mm	RU-5171-14
172 mm	29 x 18 mm	Ø 15 mm	RU-5171-15
182 mm	26 x 17/20 mm	Ø 13 mm	RU-5171-16
222 mm	26 x 17/20 mm	Ø 13 mm	RU-5171-17

ZANGEN ZUR ENDOLARYNGEALEN MIKROCHIRURGIE
FORCEPS FOR ENDOLARYNGEAL MICROSURGERY

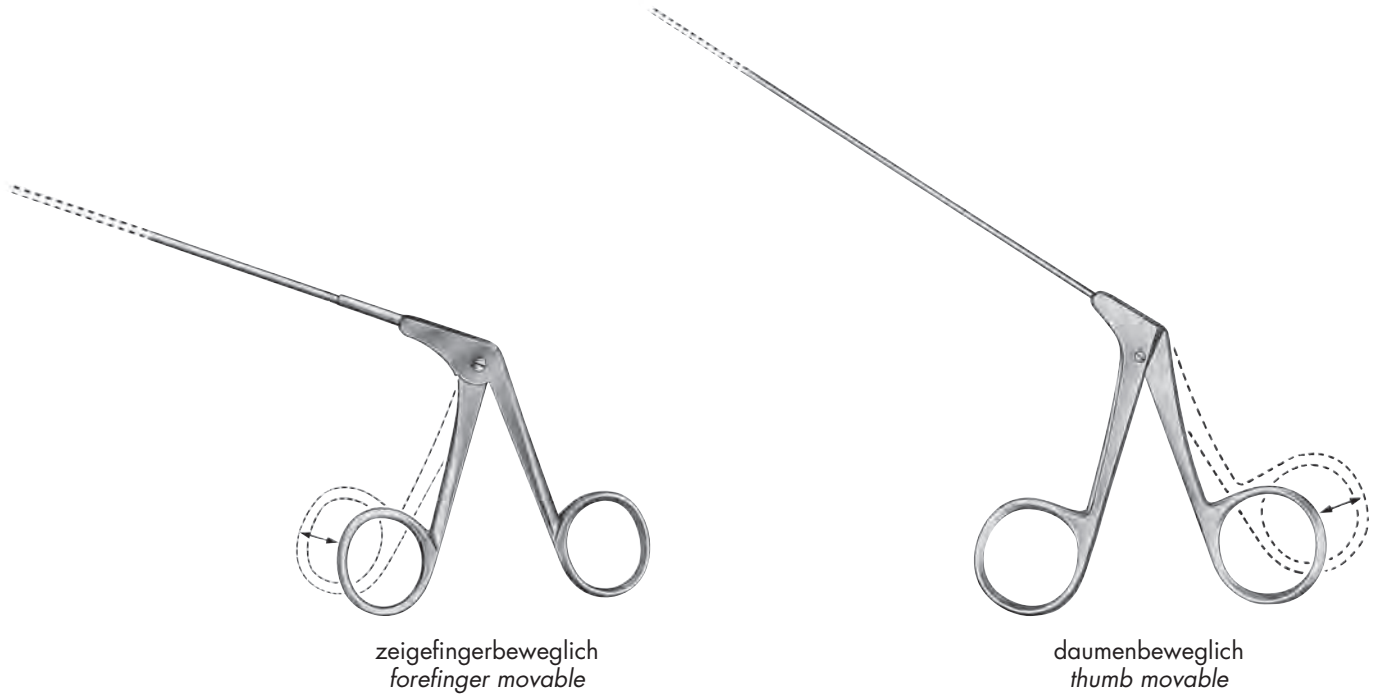



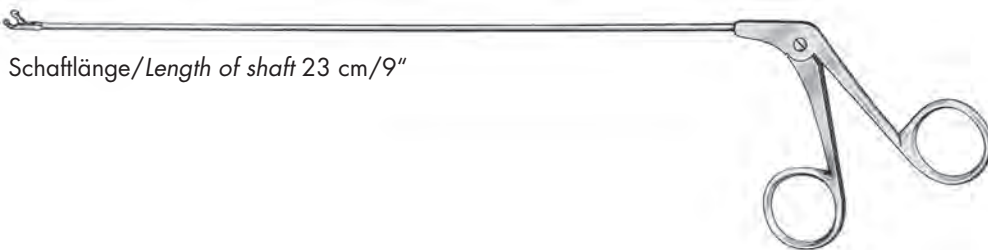

Instrumentarium zur endolaryngealen Mikrochirurgie mit neuem, konisch zulaufendem Schaft für hohe Stabilität bei gleichzeitig optimaler Sicht.

Laryngeal instruments for endolaryngeal microsurgery with new conical shaft for high stability and optimal view.









Schaftlänge/Length of shaft 23 cm/9"

Löffelzangen, Ø 4 mm Cutting forceps, Ø 4 mm		zeigefingerbeweglich forefinger movable
	gerade straight	RU 8650-00/40
	aufwärts gebogen curved upwards	RU 8650-00/43
	rechts gebogen curved right	RU 8650-00/45
	links gebogen curved left	RU 8650-00/46



ZANGEN ZUR ENDOLARYNGEALEN MIKROCHIRURGIE
FORCEPS FOR ENDOLARYNGEAL MICROSURGERY



Schaftlänge/length of shaft 23 cm/9"

Mikroscheren, Ø 2 mm Micro scissors, Ø 2 mm	zeigefingerbeweglich forefinger movable	daumenbeweglich thumb movable
 gerade straight	RU 8650-03/01	RU 8650-04/01
 gerade horizontal straight horizontal	RU 8650-03/02	RU 8650-04/02
 45° aufgewinkelt angled up 45°	RU 8650-03/03	RU 8650-04/03
 15° aufgewinkelt angled up 15°	RU 8650-03/04	RU 8650-04/04
 rechts gebogen curved right	RU 8650-03/05	RU 8650-04/05
 links gebogen curved left	RU 8650-03/06	RU 8650-04/06

Schaftlänge/length of shaft 18 cm/7"

Mikroscheren, Ø 2 mm Micro scissors, Ø 2 mm	zeigefingerbeweglich forefinger movable	daumenbeweglich thumb movable
 gerade straight	RU 8649-03/01	RU 8649-04/01
 45° aufgewinkelt angled up 45°	RU 8649-03/03	RU 8649-04/03
 rechts gebogen curved right	RU 8649-03/05	RU 8649-04/05
 links gebogen curved left	RU 8649-03/06	RU 8649-04/06

ZANGEN ZUR ENDOLARYNGEALEN MIKROCHIRURGIE
FORCEPS FOR ENDOLARYNGEAL MICROSURGERY



Schaftlänge/length of shaft 23 cm/9"

Mikro-Fasszangen, Ø 2 mm Micro forceps, Ø 2 mm		zeigefingerbeweglich forefinger movable	daumenbeweglich thumb movable
	gerade straight	RU 8650-03/11	RU 8650-04/11
	aufwärts gebogen curved upwards	RU 8650-03/13	RU 8650-04/13
	rechts gebogen curved right	RU 8650-03/15	RU 8650-04/15
	links gebogen curved left	RU 8650-03/16	RU 8650-04/16
	aufwärts gebogen rechts curved upwards right	RU 8650-03/18	RU 8650-04/18
	aufwärts gebogen links curved upwards left	RU 8650-03/19	RU 8650-04/19

Schaftlänge/length of shaft 18 cm/7"

	gerade straight	RU 8649-03/11	RU 8649-04/11
---	--------------------	----------------------	----------------------

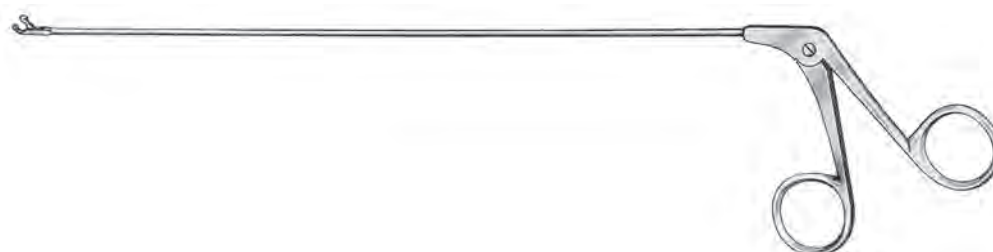

**ZANGEN ZUR ENDOLARYNGEALEN MIKROCHIRURGIE
FORCEPS FOR ENDOLARYNGEAL MICROSURGERY**





Schaftlänge/length of shaft 23 cm/9"

Mikro-Löffelzangen, Ø 2 mm Micro cutting forceps, Ø 2 mm	zeigefingerbeweglich forefinger movable	daumenbeweglich thumb movable
 gerade straight	RU 8650-03/21	RU 8650-04/21
 aufwärts gebogen curved upwards	RU 8650-03/23	RU 8650-04/23
 rechts gebogen curved right	RU 8650-03/25	RU 8650-04/25
 links gebogen curved left	RU 8650-03/26	RU 8650-04/26
 aufwärts gebogen rechts curved upwards right	RU 8650-03/30	RU 8650-04/30
 aufwärts gebogen links curved upwards left	RU 8650-03/31	RU 8650-04/31
 horizontal rechts horizontal right	RU 8650-03/32	RU 8650-04/32
 horizontal links horizontal left	RU 8650-03/33	RU 8650-04/33

Schaftlänge/length of shaft 18 cm/7"

 gerade straight	RU 8649-03/21	RU 8649-04/21
 aufwärts gebogen curved upwards	RU 8649-03/23	RU 8649-04/23

Mikro-Löffelzangen, Ø 3 mm
Micro cutting forceps, Ø 3 mm

 gerade straight	RU 8649-05/21	RU 8649-06/21
 aufwärts gebogen curved upwards	RU 8649-05/23	RU 8649-06/23





**ZANGEN ZUR ENDOLARYNGEALEN MIKROCHIRURGIE
FORCEPS FOR ENDOLARYNGEAL MICROSURGERY**









Schaftlänge/length of shaft 23 cm/9"

Mikro-Scheren, Ø 1 mm Micro scissors, Ø 1 mm	zeigefingerbeweglich forefinger movable	daumenbeweglich thumb movable
 gerade straight	RU 8650-11/01	RU 8650-12/01
 abgewinkelt 45° angled 45°	RU 8650-11/03	RU 8650-12/03
 rechts gebogen curved right	RU 8650-11/05	RU 8650-12/05
 links gebogen curved left	RU 8650-11/06	RU 8650-12/06

Mikro-Fasszangen, Ø 1 mm
Micro forceps, Ø 1 mm

 gerade straight	RU 8650-11/11	RU 8650-12/11
 aufwärts gebogen curved upwards	RU 8650-11/13	RU 8650-12/13
 rechts gebogen curved right	RU 8650-11/15	RU 8650-12/15
 links gebogen curved left	RU 8650-11/16	RU 8650-12/16

Mikro-Löffelzangen, Ø 1 mm
Micro cutting forceps, Ø 1 mm

 gerade straight	RU 8650-11/21	RU 8650-12/21
 aufwärts gebogen curved upwards	RU 8650-11/23	RU 8650-12/23
 rechts gebogen curved right	RU 8650-11/25	RU 8650-12/25
 links gebogen curved left	RU 8650-11/26	RU 8650-12/26
 aufwärts gebogen rechts curved upwards right	RU 8650-11/30	RU 8650-12/30
 aufwärts gebogen links curved upwards left	RU 8650-11/31	RU 8650-12/31





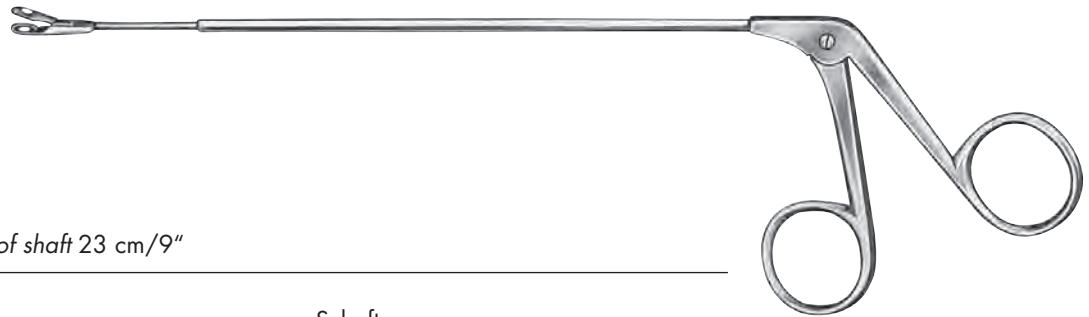

Schaftlänge/length of shaft 18 cm/7"

 aufwärts gebogen curved upwards	RU 8649-11/23	RU 8649-11/23
--	----------------------	----------------------

ZANGEN ZUR ENDOLARYNGEALEN MIKROCHIRURGIE
FORCEPS FOR ENDOLARYNGEAL MICROSURGERY



Schaftlänge/length of shaft 23 cm/9"

- | | | | |
|-------------------|---|-----------------|--|
| | | Schaft
shaft | |
| RU 8651-01 |  | Ø 2,5 mm | Zängchen mit gefenesterten Maulteilen
scharf, gerade
<i>Cutting forceps, with fenestrated jaw,
sharp, straight</i> |
| RU 8651-02 |  | Ø 2,0 mm | Zängchen mit ovalem Löffel
2 x 3 mm, gerade
<i>Cup-shaped forceps, oval 2 x 3 mm, straight</i> |
| RU 8651-05 |  | Ø 3,0 mm | Zängchen zur Probeexzision, 4 x 4,5 mm, 90° gewinkelt
<i>Biopsy punch, 4 x 4,5 mm, 90° angled</i> |
| RU 8651-10 |  | Ø 2,5 mm | Fasszange, kräftiges Modell
<i>Grasping forceps, strong</i> |
| RU 8651-11 |  | Ø 2,5 mm | Zange mit Hechtmaul
<i>Alligator grasping forceps</i> |
| RU 8651-20 |  | Ø 2,7 mm | Zange mit ovalem Löffel, kräftig
<i>Forceps, oval, strong</i> |
| RU 8651-21 |  | Ø 2,5 mm | Zange mit Löffel 4 mm, kräftig
<i>Forceps, strong</i> |

- | | | | |
|-------------------|---|--|--|
| RU 8651-40 |  | | Nadelhalter mit Sperre
<i>Needleholder with ratchet</i> |
|-------------------|---|--|--|

LARYNGOSKOPIE-INSTRUMENTE
LARYNGEAL INSTRUMENTS

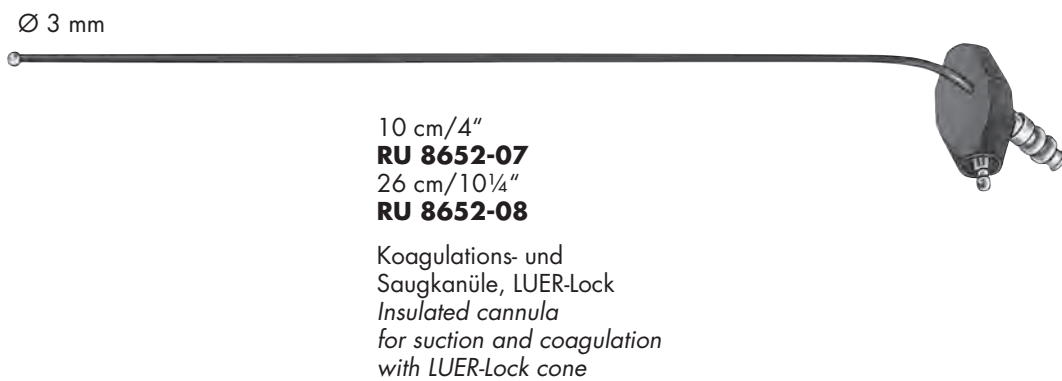

LARYNGOSKOPIE-INSTRUMENTE
LARYNGEAL INSTRUMENTS

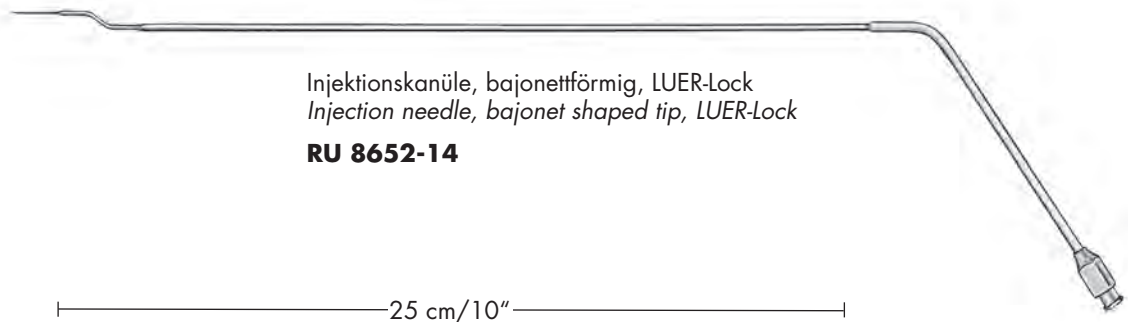

Injektionskanüle, bajonettförmig, LUER-Lock
Injection needle, bayonet shaped tip, LUER-Lock
RU 8652-14

25 cm/10"

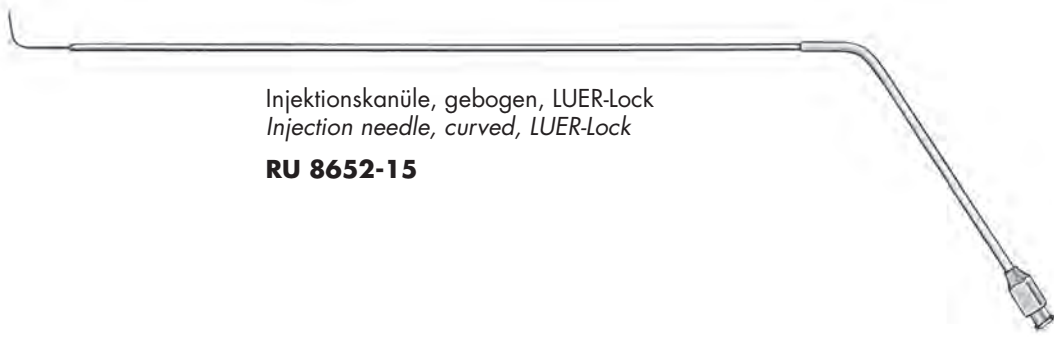

Injektionskanüle, gebogen, LUER-Lock
Injection needle, curved, LUER-Lock
RU 8652-15

25 cm/10"



Watteträger, gerade
Cotton applicator, straight
RU 8653-00

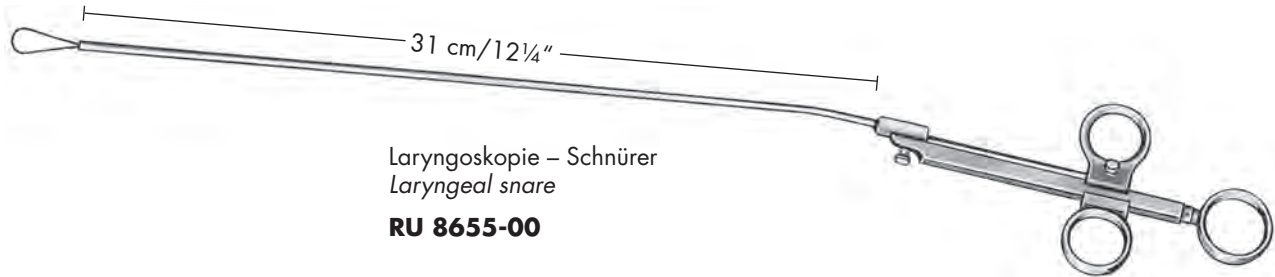

Laryngoskopie – Schnürer
Laryngeal snare
RU 8655-00

Schnürerdraht
Snare wire



0,3 mm
RU 8024-10
Packung à 12 Stück
Package of 1 dozen each

0,3 mm
RU 8024-10/00
Packung à 100 Stück
Package of 100 pieces

LARYNGOSKOPIE-INSTRUMENTE
LARYNGOSCOPY INSTRUMENTS

Handgriff für Stabinstrumente
Handle for instruments

RU 8652-00



RU 8652-21
Messer, oval, gerade
Knife, oval, straight



RU 8652-22
Messer, 45°
Knife, 45°



RU 8652-23
Messer, gebogen, spitz
Knife, curved, pointed



RU 8652-24
Messer, gerade, spitz
Knife, straight, pointed



RU 8652-25
Messer, rund, gebogen
Knife, round, curved



RU 8652-26
Messer, rund, vertikal
Knife, round, vertical cutting



RU 8652-27
Häkchen, stumpf, mit Sondenknopf
Hook, blunt, with probe end



RU 8652-28
Häkchen, scharf
Hook, sharp



RU 8652-29
Häkchen, 90°, mit Sondenknopf
Hook, with probe end, angled 90°



RU 8652-30
Nadel, rechts gebogen
Needle, curved right



RU 8652-31
Nadel, links gebogen
Needle, curved left



RU 8652-32
Saug- Raspatorium
Suction raspatory



RU 8652-33
Fadengabel
Knot tier



RU 8652-34
Messer, längs, oval
Knife, vertical, oval blade



RU 8652-35
Messer, 45° abgewinkelt
Knife, 45° angled

WATTETRÄGER
COTTON APPLICATORS

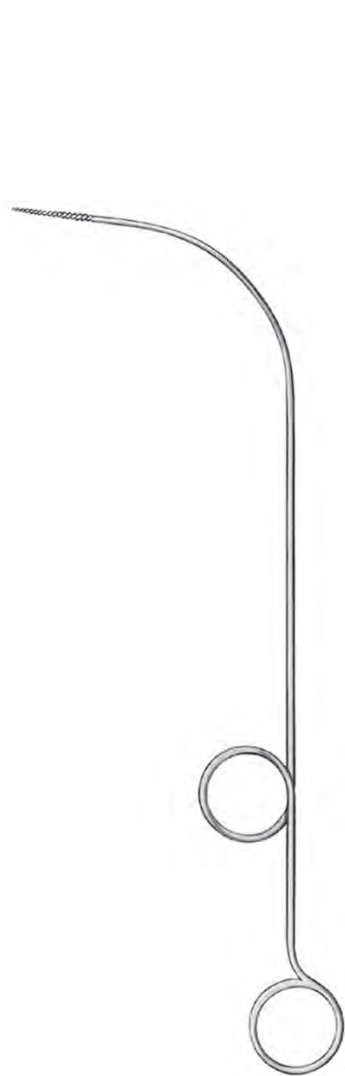

Pelteson
23 cm/9"
RU 4921-23



Fein
28 cm/11"
RU 4922-28



Killian
25 cm/10"
RU 4922-50



Bei dieser Katalog-Auflage handelt es sich um einen Nachdruck mit geringfügigen Änderungen; daher entfällt der ursprüngliche Inhalt auf dieser Seite.

This catalogue edition is a reprint with minor amendments. This is why the initial content of this page has been removed.

UNIVERSALGRIFF UND VERLÄNGERUNGSROHRE
UNIVERSAL HANDLE AND TUBES



Huber
RU 8630-00



Verlängerungsrohr, gerade
tube, straight

20 cm/8"
30 cm/12"
40 cm/16"
50 cm/20"
60 cm/24"

RU 8632-20
RU 8632-30
RU 8632-40
RU 8632-50
RU 8632-60

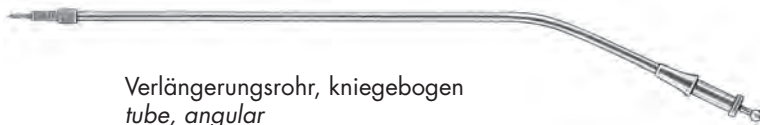

Verlängerungsrohr, kniegebogen
tube, angular

20 cm/8"
30 cm/12"
40 cm/16"
50 cm/20"
60 cm/24"

RU 8633-20
RU 8633-30
RU 8633-40
RU 8633-50
RU 8633-60

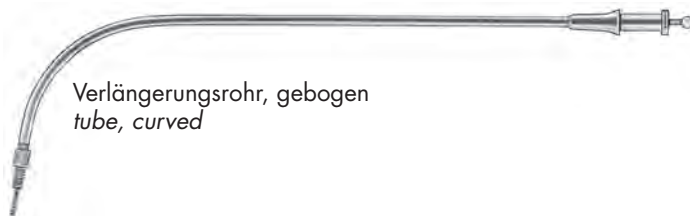

Verlängerungsrohr, gebogen
tube, curved

20 cm/8"

RU 8634-20

ZANGENAUFsätze FÜR GRIFf UND VERLÄNGERUNGSRoHR (S. 407)
FORCEPS TIPS FOR HANDLE AND TUBES (P. 407)



Seiffert
RU 8636-01



Fränkel
RU 8637-01



- Bruenings**
- 2 mm Ø **RU 8639-01**
 - 3 mm Ø **RU 8639-02**
 - 4 mm Ø **RU 8639-02/04**



Bruenings
aufgewinkelt/angled up

- 2 mm **RU 8639-03**
- 3 mm **RU 8639-03/03**
- 4 mm **RU 8639-03/04**



- Bruenings**
- **RU 8639-04**
 - **RU 8639-04/03**
 - **RU 8639-04/04**



- Krause**
- **RU 8641-01**
 - **RU 8641-02**



- Krause**
- **RU 8642-01**
 - **RU 8642-02**



- Cordes**
- **RU 8643-01**
 - **RU 8643-02**
 - **RU 8643-03**
 - **RU 8643-04**



- Schumacher**
RU 8644-01



- Cordes**
- **RU 8645-01**
 - **RU 8645-02**



- Fränkel**
RU 8648-01

**KEHLKOPFSPIEGEL UND GRIFFE
LARYNGEAL MIRRORS AND HANDLES**



Michel
25 cm/10"

	Fig.	Ø
RU 8660-06	000	6 mm
RU 8660-08	00	8 mm
RU 8660-10	0	10 mm
RU 8660-12	1	12 mm
RU 8660-14	2	14 mm
RU 8660-16	3	16 mm
RU 8660-18	4	18 mm
RU 8660-20	5	20 mm
RU 8660-22	6	22 mm
RU 8660-24	7	24 mm
RU 8660-26	8	26 mm
RU 8660-28	9	28 mm
RU 8660-30	10	30 mm

RU 8662-06
RU 8662-08
RU 8662-10
RU 8662-12
RU 8662-14
RU 8662-16
RU 8662-18
RU 8662-20
RU 8662-22
RU 8662-24
RU 8662-26
RU 8662-28
RU 8662-30

Ø	kpl./cpl.	Spiegel allein/ mirror only
12 mm	RU 8664-12	RU 8664-42
14 mm	RU 8664-14	RU 8664-44
16 mm	RU 8664-16	RU 8664-46
18 mm	RU 8664-18	RU 8664-48

**Spiegelgriffe
Mirror handles**



11 cm/4³/₈"
RU 8666-01



10,5 cm/4¹/₈"
RU 8666-02

**KEHLKOPFZANGEN
LARYNGEAL FORCEPS**

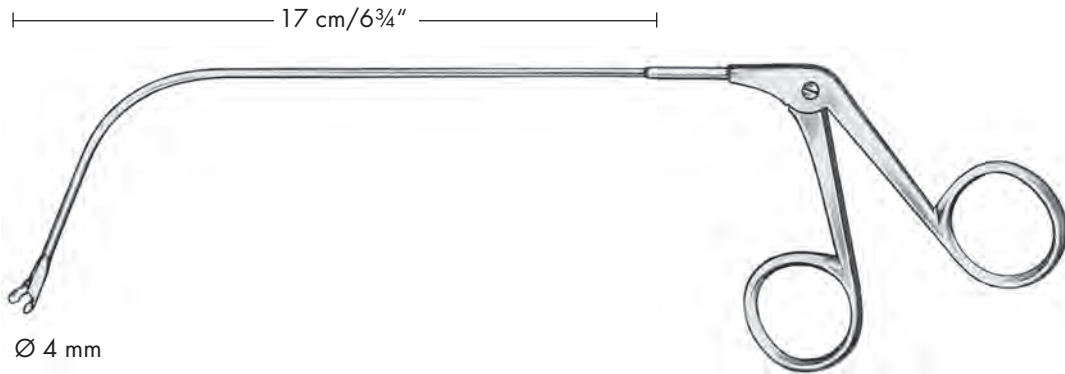

RU 8688-01

gerade/straight



RU 8688-03

rechts gebogen/curved right



RU 8688-02

aufgebogen/curved up



RU 8688-04

links gebogen/curved left

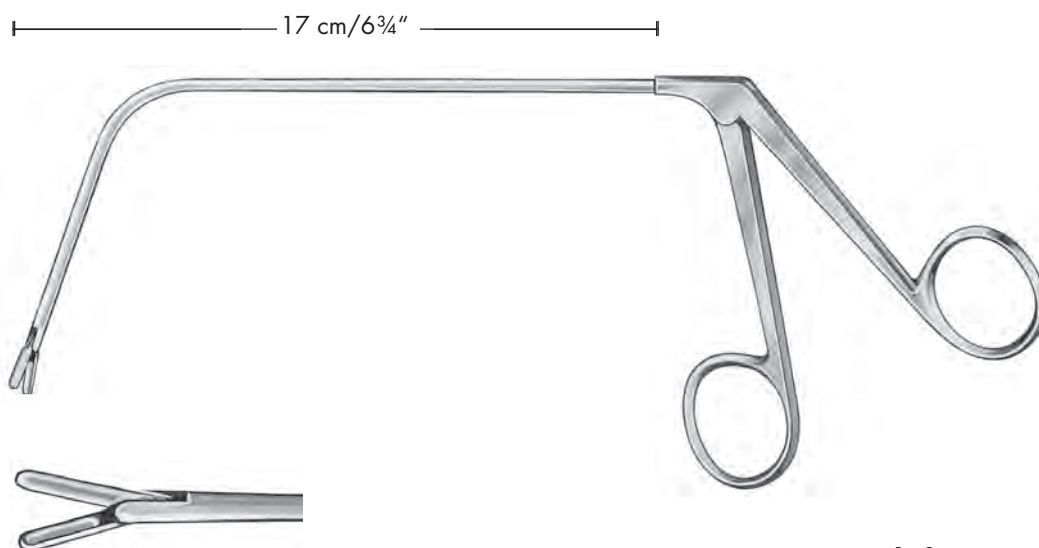

Fraenkel

25 cm/10"

RU 8689-01

Kehlkopf-Fremdkörperzange
Laryngeal polypus forceps

**KEHLKOPFZANGEN, KEHLDECKELHALTER, LARYNGOFISSUR-SCHERE
LARYNGEAL FORCEPS, EPIGLOTTIS RETRACTOR, LARYNGECTOMY SCISSORS**

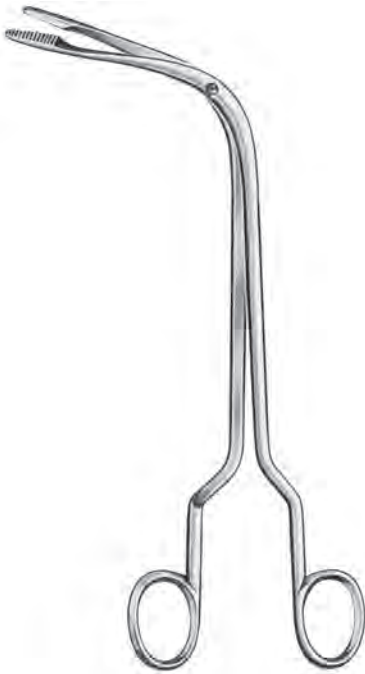

Fraenkel
18 cm/7"
RU 8680-18



RU 8690-01
nach rechts öffnend
opening right

RU 8690-02
nach links öffnend
opening left

RU 8690-03
nach unten öffnend
opening downwards

RU 8690-04
nach oben öffnend
opening upwards



Jurasz
23 cm/9"



Reichert
24 cm/9½"
RU 8692-24



Killian
20 cm/8"
RU 8695-20

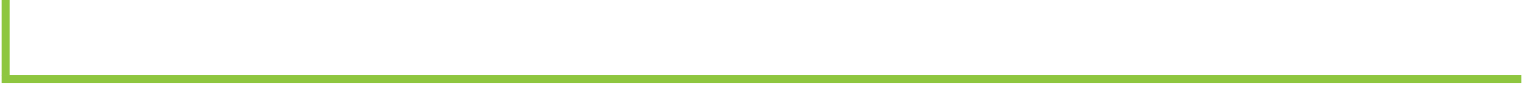

BRONCHOSKOPIE

OESOPHAGOSKOPIE

BRONCHOSCOPY

OESOPHAGOSCOPY

Seiten 413 - 416

Pages 413 - 416

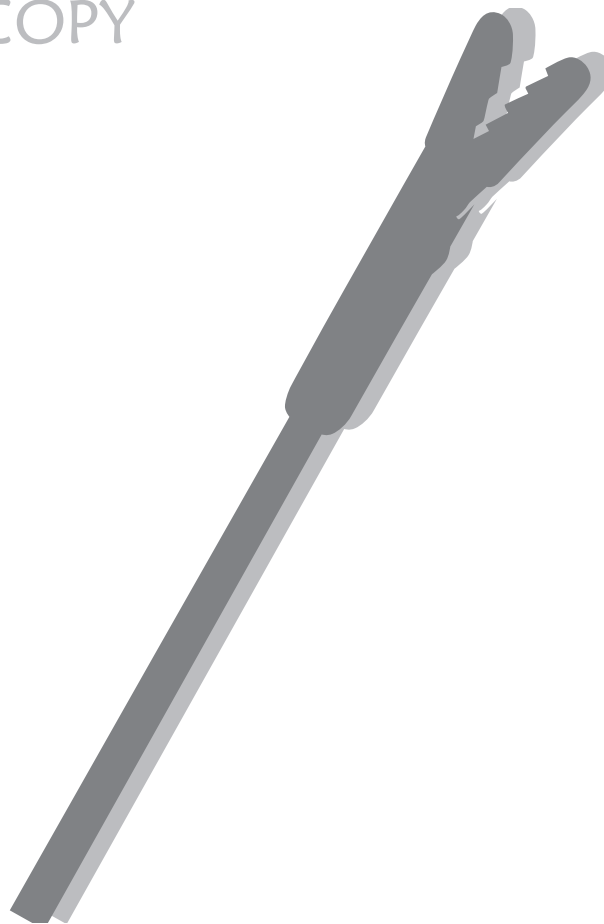

Übersicht

Zangen
Watteträger

Overview

Forceps
Cotton applicators

Seiten / Pages

414-416
416

ZANGEN FÜR LARYNGO-BRONCHO-OESOPHAGOSKOPIE
FORCEPS FOR LARYNGO-BRONCHO-ESOPHAGOSCOPY

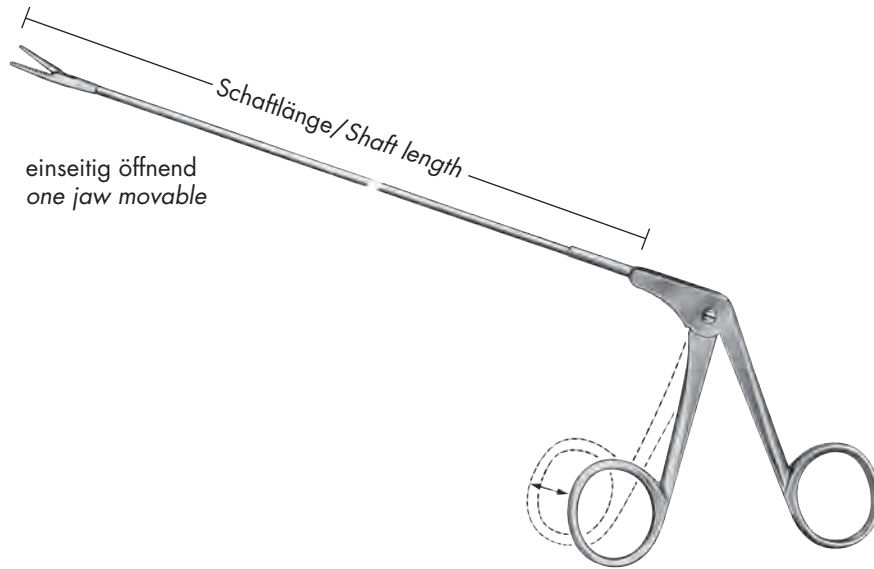

für Kinder
for children

Rohrschaft/tube shaft Ø 2,0 mm
Schaftlänge/length of shaft 35 cm/14"

Rohrschaft/tube shaft Ø 2,5 mm

		Schaftlänge length of shaft	35 cm/14"	40 cm/16"	50 cm/20"	55 cm/22"	60 cm/24"
	RU 8619-01/35		RU 8619-20/35	RU 8619-20/40	RU 8619-20/50	RU 8619-20/55	RU 8619-20/60
	RU 8619-02/35		RU 8619-21/35	RU 8619-21/40	RU 8619-21/50	RU 8619-21/55	RU 8619-21/60
	RU 8619-03/35		RU 8619-22/35	RU 8619-22/40	RU 8619-22/50	RU 8619-22/55	RU 8619-22/60
	RU 8619-04/35		RU 8619-23/35	RU 8619-23/40	RU 8619-23/50	RU 8619-23/55	RU 8619-23/60
	RU 8619-05/35		RU 8619-24/35	RU 8619-24/40	RU 8619-24/50	RU 8619-24/55	RU 8619-24/60
	RU 8619-06/35		RU 8619-30/35	RU 8619-30/40	RU 8619-30/50	RU 8619-30/55	RU 8619-30/60
	RU 8619-07/35		RU 8619-31/35	RU 8619-31/40	RU 8619-31/50	RU 8619-31/55	RU 8619-31/60
	RU 8619-08/35		RU 8619-32/35	RU 8619-32/40	RU 8619-32/50	RU 8619-32/55	RU 8619-32/60
	RU 8619-09/35		RU 8619-33/35	RU 8619-33/40	RU 8619-33/50	RU 8619-33/55	RU 8619-33/60
	RU 8619-10/35						
	RU 8619-11/35						

**ZANGEN FÜR BRONCHOSKOPE UND OESOPHAGOSKOPE
BRONCHOSCOPIC AND ESOPHAGOSCOPIC FORCEPS**

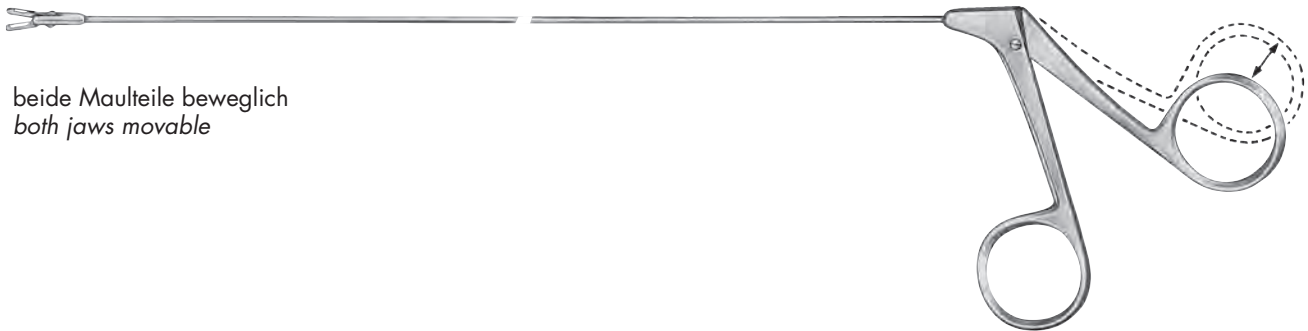

beide Maulteile beweglich
both jaws movable



Nutzlänge/Working length 25 cm/10"
Schaftstärke/Shaft diam. Ø 1,5 mm **RU 8619-70/01 RU 8619-70/02 RU 8619-70/03 RU 8619-70/04**

Nutzlänge/Working length 35 cm/14"
Schaftstärke/Shaft diam. Ø 1,5 mm **RU 8619-71/01 RU 8619-71/02 RU 8619-71/03 RU 8619-71/04**

Nutzlänge/Working length 35 cm/14"
Schaftstärke/Shaft diam. Ø 2,0 mm **RU 8619-72/01 RU 8619-72/02 RU 8619-72/03 RU 8619-72/04**

Nutzlänge/Working length 45 cm/18"
Schaftstärke/Shaft diam. Ø 2,0 mm **RU 8619-73/01 RU 8619-73/02 RU 8619-73/03 RU 8619-73/04**



Nutzlänge/Working length 55 cm/22"
Schaftstärke/Shaft diam. Ø 2,5 mm **RU 8619-80/01 RU 8619-80/02 RU 8619-80/03 RU 8619-80/04 RU 8619-80/05**

Nutzlänge/Working length 60 cm/24"
Schaftstärke/Shaft diam. Ø 2,5 mm **RU 8619-81/01 RU 8619-81/02 RU 8619-81/03 RU 8619-81/04 RU 8619-81/05**

**WATTETRÄGER, BRONCHO – OESOPHAGOSKOPIEZANGEN
COTTON APPLICATORS, BRONCHO – ESOPHAGOSCOPY FORCEPS**



Chevalier-Jackson

Länge
Length



4 mm



30 cm/12"

RU 8620-30

RU 8621-30

RU 8622-30

RU 8623-30

40 cm/16"

RU 8620-40

RU 8621-40

RU 8622-40

RU 8623-40

50 cm/20"

RU 8620-50

RU 8621-50

RU 8622-50

RU 8623-50

60 cm/24"

RU 8620-60

RU 8621-60

RU 8622-60

RU 8623-60

Länge
Length



4 mm



40 cm/16"

RU 8625-40

RU 8626-40

50 cm/20"

RU 8625-50

RU 8626-50

60 cm/24"

RU 8625-60

RU 8626-60

REINIGUNG · PFLEGE

STERILISATION

CLEANING · CARE

STERILIZATION

Seiten 417 - 430

Pages 417 - 430

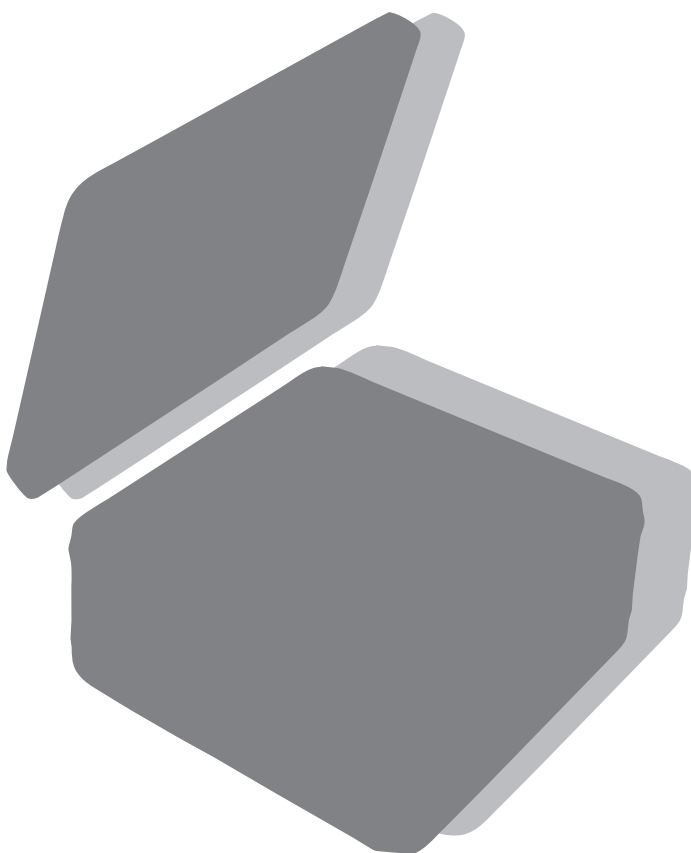

Übersicht

Reinigungspistolen, Aufsätze, Bürsten
Zubehör
Pflegeprodukte
Sterilisations-Zubehör, Container
Instrumentenkassetten
Container-Zubehör
Nadeldosen, Spirituslampen, Schalen
Behälter

Overview

Water-jet pistol, tips, brushes
Accessories
Maintenance products
Sterilizing accessories, containers
Instrument cases
Container accessories
Needle cases, spirit lamps, culture dishes
Receptacles

Seiten / Pages

418-419
420
421
422-423, 428
424-427
428
429
430

REINIGUNGSPISTOLE SPRAY GUN

Die Reinigung mit Wasser oder Druckluft ist besonders schnell, effizient und damit kostensparend.

Bei der neuen Reinigungspistole ist der Wasser- oder Luftstrahl durch eine neuartige Dosiermechanik stufenlos über die gesamte Betätigungsstrecke des Abzughahns fein dosierbar. Der maximale Wasser- oder Luftfluss kann auch mit der kleinen Rändelschraube hinter dem Abzughahn individuell eingestellt werden.

The Spray Gun uses either water or pressurized air - this means the cleaning process is quick, efficient and inexpensive.

The Spray Gun features a new type of internal flow control mechanism. It permits the smooth and simple adjustment of the water or air flow across the entire range of the trigger movement. The desired maximum water or air flow can be set by using the small knurled screw located behind the trigger. It is then regulated via the trigger up to the set maximum value.



- RU 8867-05** Reinigungspistole ohne Zubehör
Spray gun without accessories
- RU 8867-06** Reinigungspistole mit Konus und 1,5 m Schlauch, ohne Anschluss
Spray gun with conus and 1.5 m tubing without connector
- RU 8867-07** Reinigungspistole mit Konus und 3 m Schlauch, ohne Anschluss
Spray gun with conus and 3 m tubing without connector
- RU 8867-08** Reinigungspistole mit 1,6 m Metallschlauch, Konus, Tischverschraubung und 3/4" Anschluss (komplett montiert)
Spray gun with 1.6 m metal tubing conus and tabletop rosette, 3/4" connection mounted
- RU 8867-11** Reinigungspistole mit 1,5 m Schlauch und Konus, mit Standardset (RU 8867-25) und 1/2" Anschluss (lose), siehe Seite 419
Spray gun with conus and 1.5 m tubing, with Set RU 8867-25 and connector 1/2", see page 419
- RU 8867-12** Reinigungspistole mit 1,5 m Schlauch und Konus, mit Standardset (RU 8867-25) und 3/4" Anschluss (lose), siehe Seite 419
Spray gun with conus and 1.5 m tubing, with Set RU 8867-25 and connector 3/4", see page 419

ZUBEHÖR ZU REINIGUNGSPISTOLEN, REINIGUNGSBÜRSTEN ACCESSORIES FOR SPRAY GUNS, CLEANING BRUSHES

zusätzliche Ansätze
additional connectors

RU 8867-25

Standard Set
bestehend aus:
Standard Set,
consisting of:

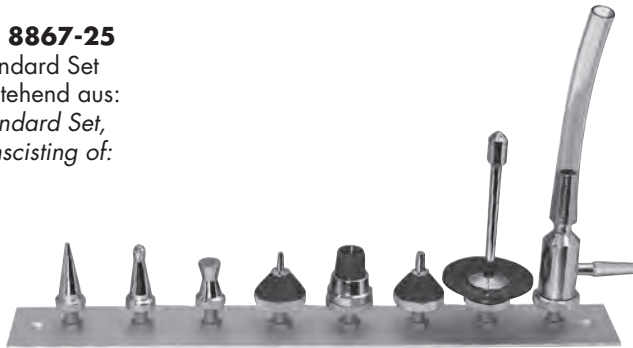

A B C D E F G H

- A **RU 8867-40** für Katheter, Ventile etc. *for catheters, valves etc.*
- B **RU 8867-41** für Drainageschläuche *for drainage tubings*
- C **RU 8867-42** Brause für Flächen und Hohlräume *spray jet for rinsing out glassware etc.*
- D **RU 8867-43** für Spritzen und Kanülen mit Rekordkonus *for syringes and cannulae with Rekord cone*
- E **RU 8867-44** für Mess- und Blutpipetten *for measuring and blood pipettes*
- F **RU 8867-45** für Spritzen und Kanülen mit LUER-Konus *for syringes and cannulae with LUER cone*
- G **RU 8867-46** für Flaschen und Erlenmeyer-Kolben *for bottles and Erlenmeyer flasks*
- H **RU 8867-47** Wasserstrahlpumpe zum Absaugen *water-jet pump for suction cleaning*

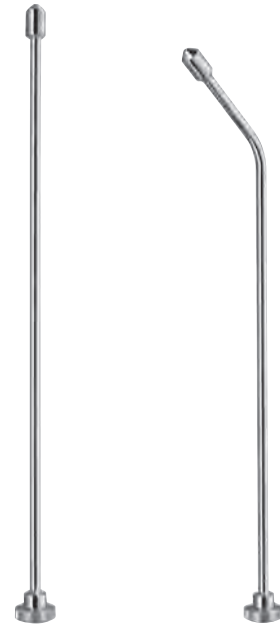

M

N

- M **RU 8867-51** Düse für Gefäße und Kolben 25 cm *long nozzle, straight 10"*
- N **RU 8867-52** Winkeldüse für hohe Gefäße 25 cm *long nozzle, angled, 10"*



3/4"

- RU 8867-33** Anschluss 3/4" komplett *Connector 3/4" complete*
- RU 8867-34** Anschluss 1/2" komplett *Connector 1/2" complete*
- RU 8867-36** Reduzierring 1/2" und 3/8" (ohne Abbildung) *Reducer 1/2" and 3/8" (without illustration)*
- RU 8867-37** Reduzierring 1/2" und Perlator (ohne Abbildung) *Reducer 1/2" and water nozzle (without illustration)*

Reinigungsbürsten Cleaning brushes



Länge Length	Ø 2,5 mm	Ø 7 mm	Ø 11 mm
38 cm/15"	RU 8865-51	RU 8865-55	8865-59
50 cm/20"	RU 8865-52	RU 8865-56	8865-60

**ZUBEHÖR
ACCESSORIES**



Child
24 cm/9½"
RU 6524-24

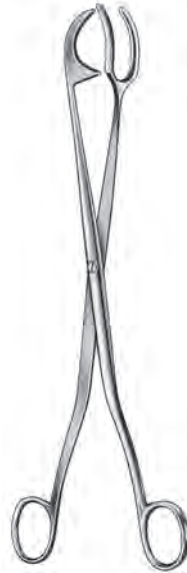

Rogge
23 cm/9"
RU 8946-23



14 cm/5½"
RU 8871-14HP

rostfrei
stainless



10 cm/4"
RU 8876-10



10 cm/4" **RU 8879-10**

**PFLEGEPRODUKTE
MAINTENANCE PRODUCTS**

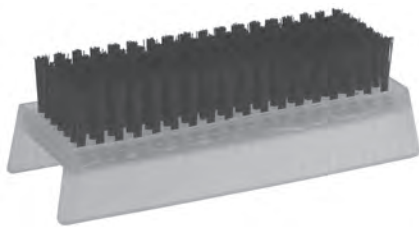

RU 8865-00

Handwaschbürsten
mehr als 400 mal autoklavierbar
Nailbrushes
more than 400 times autoclavable



1/3

RU 8880-00

Ölspray (FCKW-frei)
zur Instrumentenpflege, 500 ml
Oil spray
(without fluorochlorhydrocarbon)
for instrument care, 500 ml



RU 8880-03

RUDOLF Care
Instrumentenöl, 100 ml
instrument oil, 100 ml



RU 8880-05

Antibeschlagmittel, für Optiken, steril, 30 ml
Antifog solution for optics, sterile, 30 ml

RU 8880-06

Antibeschlagmittel, 25 ml, Pipetten-Flasche
Antifog solution, 25 ml, pipette bottle

RU 8880-07

Antibeschlagmittel, 15 ml, Spritzflasche
Antifog solution, 15 ml, spray bottle



RZ010-030

Reinigungsfluid für Optiken
Cleaning solution
for endoscopes



RU 8880-50

Pflegefett für Hähne, 40 g
Lubricant for stopcocks, 40 g

STERILISATIONS-ZUBEHÖR FÜR ENDOSKOPE
STERILIZING ACCESSORIES FOR ENDOSCOPES

autoklavierbar/autoclavable
max. 134°C, 2,3 bar



Schutzhülse für Endoskope bis Ø 5 mm
Protection shield for endoscopes up to Ø 5 mm
RZ010-000

Endoskopsiebkorb
Wire basket for endoscopes

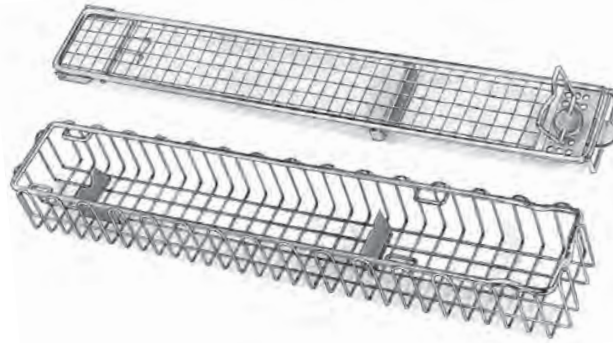

290 x 80 x 52 mm
RU 8908-01

460 x 80 x 52 mm
RU 8908-11

670 x 80 x 52 mm
RU 8908-02

Kunststoffbehälter für Endoskope
Plastic container for endoscopes

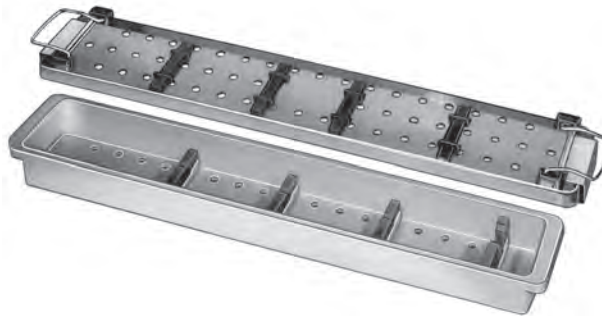

500 x 80 x 40 mm
RU 8908-12

Aluminium-Endoskop-Behälter
Aluminium endoscope container

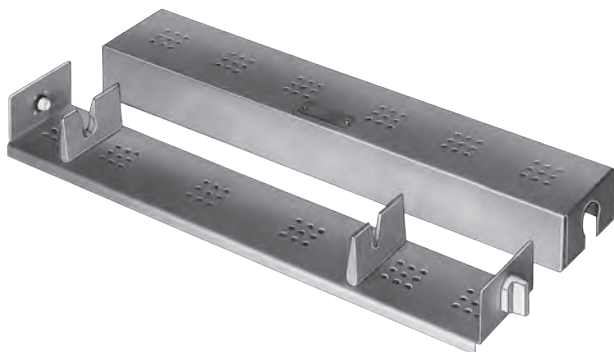

Länge length	Für Optiken for Endoscopes Ø	
300 mm	4 mm	RU 8909-05
400 mm	2 mm	RU 8909-07
400 mm	3 mm	RU 8909-08
400 mm	5 mm	RU 8909-10
400 mm	10 mm	RU 8909-11
400 mm	4 mm	RU 8909-12

Edelstahl-Siebkorb
Stainless steel wire basket



240 x 258 x 50 mm
RU 8901-50

Silikon-Noppenmatten
Silicone mats

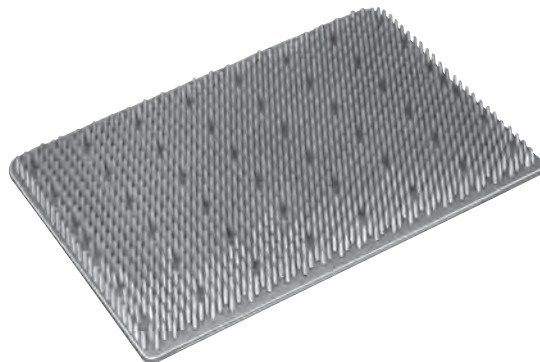

200 x 140 mm **RU 8905-30**
265 x 255 mm **RU 8905-32**

INSTRUMENTENKASSETTEN AUS EDELSTAHL MIT SILIKONEINRICHTUNG
STAINLESS STEEL INSTRUMENT CASES WITH SILICONE RACKS

herausnehmbare Siebplatte
removable perforated plate

Organisationshilfe durch farbige
Kennzeichnungsschilder
*Coloured identification labels
for ideal organization*



Silikon-Andrückleisten zum
Fixieren der Instrumente
*Silicone squeezing ledges
to fix the instruments*

Silikon-Noppenstreifen zur schonenden
Auflage der Instrumente
*Silicone cushioning stripes
for careful application*

Deckel gelocht – Boden gelocht
Lid perforated – Bottom perforated

mit Langzeit-Textilfilter
with textile filters

Langzeit-Textilfilter, allein
Long-term textile filters, only

200 x 140 x 50 mm	RU 8902-01	RU 8907-01
400 x 100 x 50 mm	RU 8902-02	RU 8907-02
400 x 150 x 50 mm	RU 8902-03	RU 8907-03
280 x 195 x 50 mm	RU 8902-04	RU 8907-04
265 x 255 x 50 mm	RU 8902-05	RU 8907-05
370 x 190 x 50 mm	RU 8902-06	RU 8907-06
380 x 260 x 50 mm	RU 8902-07	RU 8907-07
430 x 230 x 50 mm	RU 8902-08	RU 8907-08
470 x 250 x 50 mm	RU 8902-09	RU 8907-09

INSTRUMENTENKASSETTEN AUS EDELSTAHL MIT SILIKONEINRICHTUNG STAINLESS STEEL INSTRUMENT CASES WITH SILICONE RACKS

Optimale Nutzung durch
2-fach Lagerung
Space saving storage on 2 racks

Silikon-Andrückleisten an der
Unterseite des Siebes
*Silicone squeezing ledges
underneath the upper plate*

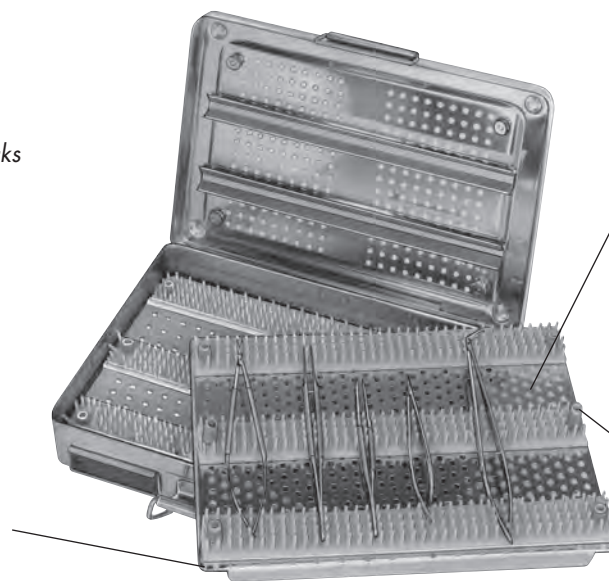

2 herausnehmbare Siebplatten
2 removable perforated plates

wärmeisolierte Halteknöpfe
zum Herausnehmen
*insulated knobs to
seize the tray*

Deckel gelocht – Boden gelocht
Lid perforated – Bottom perforated

mit Langzeit-Textilfilter
with textile filters

Langzeit-Textilfilter, allein
Long-term textile filters, only

200 x 140 x 50 mm	RU 8903-01	RU 8907-01
400 x 100 x 50 mm	RU 8903-02	RU 8907-02
400 x 150 x 50 mm	RU 8903-03	RU 8907-03
280 x 195 x 50 mm	RU 8903-04	RU 8907-04
265 x 255 x 50 mm	RU 8903-05	RU 8907-05
370 x 190 x 50 mm	RU 8903-06	RU 8907-06
380 x 260 x 50 mm	RU 8903-07	RU 8907-07
430 x 230 x 50 mm	RU 8903-08	RU 8907-08
470 x 250 x 50 mm	RU 8903-09	RU 8907-09

INSTRUMENTENKASSETTEN AUS EDELSTAHL MIT SILIKONEINRICHTUNG
STAINLESS STEEL INSTRUMENT CASES WITH SILICONE RACKS



Lagerung der Instrumente auf Silikonbank, besonders geeignet für die Lagerung von kompletten Instrumentensätzen. Die einzelnen Aussparungen sind der Stärke des jeweiligen Instruments angepasst.

Instrument storage on silicone benches recommended for complete instrument sets. The bench is exactly adapted to each instrument.

Deckel gelocht – Boden gelocht
Lid perforated – Bottom perforated

mit Langzeit-Textilfilter
with textile filters

Langzeit-Textilfilter, allein
Long-term textile filters, only

200 x 140 x 50 mm	RU 8904-01/01	RU 8907-01
400 x 100 x 50 mm	RU 8904-02/01	RU 8907-02
400 x 150 x 50 mm	RU 8904-03/01	RU 8907-03
280 x 195 x 50 mm	RU 8904-04/01	RU 8907-04
265 x 255 x 50 mm	RU 8904-05/01	RU 8907-05
370 x 190 x 50 mm	RU 8904-06/01	RU 8907-06
380 x 260 x 50 mm	RU 8904-07/01	RU 8907-07
430 x 230 x 50 mm	RU 8904-08/01	RU 8907-08
470 x 250 x 50 mm	RU 8904-09/01	RU 8907-09



Bei dieser Katalog-Auflage handelt es sich um einen Nachdruck mit geringfügigen Änderungen; daher entfällt der ursprüngliche Inhalt auf dieser Seite.

This catalogue edition is a reprint with minor amendments. This is why the initial content of this page has been removed.

**CONTAINER, ZUBEHÖR
CONTAINERS, ACCESSORIES**



RU 8905-01

Container 200 x 100 x 40 mm
mit Langzeit-Textilfilter
with textile filters

Deckel gelocht – Boden gelocht
Lid perforated – bottom perforated

RU 8907-31

Langzeit-Textilfilter, allein
Long-term textile filters, only
Packung à 10 Stück
package of 10 pieces

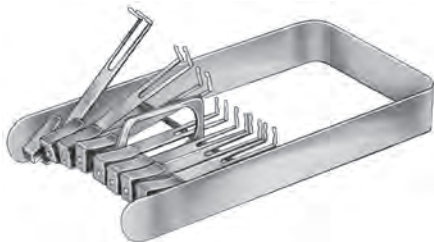

RU 8905-50

Rotations-Rack 190 x 96 x 35 mm
Rotation rack 190 x 96 x 35 mm
für 8 Instrumente
for 8 instruments



RU 8905-50/11

Magnet-Rack 190 x 96 x 35 mm
Magnetic rack 190 x 96 x 35 mm

NAELEDOSEN, SPIRITUSLAMPEN, NIERENSCHALEN
NEEDLE CASES, SPIRIT LAMPS, KIDNEY BOWLS

Nadeldosen
Needle cases



150 x 95 x 13 mm
RU 8914-00



65 mm x 16 mm
RU 8916-01



Innendose allein
Inner case only
RU 8916-11

Spirituslampe, Glas
Spirit lamp, glass



ca. 100 ml
RU 8966-01

Docht, einzeln
Wick, only
RU 8966-11

Petri-Doppelschale, Glas
Double culture dish, glass



Ø 10 cm **RU 8967-10**
Ø 12 cm **RU 8967-12**

Nierenschalen
Kidney bowls



0,25 l 170 x 36 mm **RU 8970-01**
0,50 l 250 x 36 mm **RU 8970-02**
0,75 l 275 x 45 mm **RU 8970-03**

BEHÄLTER
RECEPTACLES

Medizinbecher
Medicine cups



25 cc **RU 8975-05**
50 cc **RU 8975-10**



Glasschale mit rostfreiem Deckel
Glass jar with stainless lid

17 cm x 9 cm
20 cm x 10 cm
22 cm x 15 cm
27,5 cm x 15 cm

RU 8981-02
RU 8981-03
RU 8981-04
RU 8981-05

Schale allein
Jar only

RU 8981-12
RU 8981-13
RU 8981-14
RU 8981-15

Deckel allein
Lid only

RU 8981-22
RU 8981-23
RU 8981-24
RU 8981-25

Standgefäße
Jars



Ø x h
30 x 80 mm **RU 8984-01**
35 x 100 mm **RU 8984-02**
50 x 120 mm **RU 8984-03**
60 x 130 mm **RU 8984-04**
75 x 140 mm **RU 8984-05**
75 x 175 mm **RU 8984-06**
100 x 150 mm **RU 8984-07**

Schalen
Bowls



Ø x h
40 x 19 mm 0,05 l **RU 8985-00/01**
61 x 30 mm 0,07 l **RU 8985-00/02**
80 x 40 mm 0,14 l **RU 8985-01**
116 x 50 mm 0,35 l **RU 8985-02**
128 x 55 mm 0,45 l **RU 8985-03**
147 x 65 mm 0,7 l **RU 8985-04**
167 x 75 mm 1,1 l **RU 8985-05**
187 x 85 mm 1,6 l **RU 8985-06**

INHALTSVERZEICHNIS

Seiten 431 – 442



INHALTSVERZEICHNIS

Abfallzangen.....	420	Behälter.....	430
Abraham Tonsillenfasszangen.....	341	Behälter für Elektroden.....	31
Tonsillennmesser.....	338	Bellucci Mikro-Ohrscheren.....	205, 207, 218
Absaugrohre.....	151, 152	Wundsperrer.....	102, 169
Adapter für Hochfrequenz-Geräte.....	23	Bergmann Wundhäkchen.....	92
Adenotome.....	323	BETA 200 Otoskope.....	116
Adson Anatomische Pinzetten, TC.....	79, 255	Beyer Hohlmeißelzangen.....	136, 137, 179, 180
Arterienklemmen.....	73	Knochenstanzen.....	184
Atraumatische Pinzetten.....	87, 256	Biegegerät für Draht-Prothesen.....	233
Chirurgische Pinzetten.....	83, 255	Billeau Schlingen.....	236
Adson Standard Anatomische		Biopsiezangen.....	281, 354, 363
Pinzetten.....	79, 255	Bipolar Elektroden.....	32, 33
Adson-Brown Chirurgische Pinzetten.....	83	Kabel.....	28, 29
Agnew (Politzer) Parazentesenadeln.....	239	Pinzetten, TC.....	16–19
Akkugriffe.....	116	Bipolar-Elektroden System.....	32, 33
Akkukauter.....	37	Birkett Arterienklemmen.....	74
Allis Fasszangen,		Blakesley-Rudolf Siebbeinzangen.....	284, 356
Tonsillenfasszangen.....	78, 340	Bloch Fadengabeln.....	237
Alm Wundsperrer.....	99	Blohmke Tonsillenfasszangen.....	341
Aluminium-Endoskopbehälter.....	422	Blumenthal Hohlmeißelzangen.....	136
Anatomische Pinzetten, -TC.....	79–82, 165, 166, 255–257, 276	Böhler Hohlmeißelzangen.....	137, 180
Anlegezangen für Bulldogklemmen.....	77	Knochensplitterzangen.....	138, 181
Anschlusskabel für Elektrodenhandgriffe.....	21	Böttcher Tonsillenscheren.....	54, 320
Anschlusskabel für Neutralelektroden.....	25	Bohrer.....	157, 158
Antibeschlagentmittel.....	421	Bohrerblock für 24 Bohrer.....	159
Arterienklemmen.....	68–74, 253	Boies Nasenfrakturaufrichter.....	316
Asch Septumrichtzangen.....	318	Bose Trachealhaken, -sperrer.....	378, 379
Atrauma-Arterienklemmen.....	71	Boucheron Ohrspekula.....	187
Atraumatische Pinzetten.....	86, 87, 256	Bowman Dilatatoren.....	111
Ätzspatel	258	Nasenspekula.....	272
Aufricht Nasenflügelhaken.....	314	Braun Fasszangen.....	78
Nasenraspeln.....	305, 307	Brenner für Kauter.....	36, 37
Aufsätze für Universalgriffe.....	407	Brown Nadelhalter.....	142
Baby-Adson Arterienklemmen.....	73	Brünings Ohrspekula.....	189
Baby-Crile Arterienklemmen.....	69, 70	Septummesser, -zangen.....	279, 290
Baby-Crile-Wood Nadelhalter, TC.....	144	Tonsillennmesser, -schnürer.....	338, 342
Baby-Lexer (Knapp) Feine Scheren.....	50	Zangenaufsätze.....	408
Baby-McIntosh Laryngoskope.....	385	Zungenspatel.....	334
Baby-Metzenbaum Präparierscheren, – SUPERCUT.....	43, 244	Brünings (Moshier) Intubationsrohre.....	378
Baby-Mixter Arterienklemmen.....	74	Brünings-Brunk Kieferhöhlenhaken.....	321, 350
Baby-Molt Mundsperrer.....	330	Bruststützen für Laryngoskopie.....	392
Baby-Olsen-Hegar Nadelhalter, TC.....	147	für Mundsperrer.....	329
Baby-Overholt Arterienklemmen.....	74	Buchwald Zungenspatel.....	333
Baby-Roux Wundhaken.....	94, 321, 350	Buck Fremdkörperheber.....	200
Backhaus Tuchklemmen.....	75	Küretten.....	236
Ballenger Hohlmeißel.....	297	Watteträger.....	171
Septummesser.....	290	Buckingham Mikromesser.....	232
Tonsillenfasszangen.....	340	Bulldogklemmen.....	77, 87
Bane-Hartmann Hohlmeißelzangen.....	135	Caplan Septumscheren.....	286
Baracani Zangenaufsätze.....	408	Caspar Skalpellgriffe für Miniklingen.....	108
Barany Lärmtrommel.....	192	Castroviejo Chirurgische Pinzetten.....	88
Barbara Mikronadeln.....	226, 228	Fasspinzetten.....	257
Barnes Saugrohre.....	196	Rasierklingenhalter.....	109
Barnhill Ringmesser.....	322	Chadwick Feine Scheren.....	64, 252
Baron Saugrohre.....	197	Chevalier-Jackson Broncho-Oesophagoskopiezangen.....	416
Barraquer Mikro-Nadelhalter.....	141	Child Abfallzangen.....	420
Barsky Trachealhäkchen.....	90	Chirurgische Nadeln.....	140
Barth Löffel.....	236	Chirurgische Pinzetten, -TC.....	83–85, 88, 165, 166, 255–257
Barth-Preysing Scharfe Löffel.....	132, 176	Chirurgische Scheren, -fein.....	40–43, 47–49
Batteriebox.....	124	Cinelli Osteotome.....	302
Batteriegehäuse für Nystagmus-Brillen.....	172	Citelli Knochenstanzen.....	184
Batteriegriffe für Laryngoskope und Otoskope.....	114–117, 384, 389	Citelli (-Beyer) Kieferhöhlenstanzen.....	365
Beales Raspatorien.....	231	Clar Stirnlampen.....	120, 121
Sehnenmesser.....	225	Claus Tonsillennadeln.....	335
Beckmann Nasenspekula.....	262	Claus van Eicken Fadenfänger.....	336
Ringmesser.....	321, 322	Tonsillennadeln.....	336

INHALTSVERZEICHNIS

Cleveland Hohlmeißelzangen	135	Elektroden, bipolar	32-35
Knochensplitterzangen	181	monopolar	30
Coakley Kieferhöhlenküretten	371	Elektrodenbehälter	31
Trokare	125	Elektrodenhandgriffe	21-24
Collar Button Paukenröhrchen	210	Elektroden-Zubehör	31
Collin Zungenzangen	334	Elevatorien,	
Columellapinzetten	88, 257, 314	Kieferhöhlen-	371
Colver Tonsillenfasszangen	341	Periost-	295
Conchotome	285, 345	Septum-	291-295, 316
Cone (Adson-Baby) Wundsperrer	103	Tonsillen-	338-340
Container	422-428	Elevatorien	134, 135, 178, 216, 229, 231, 338-340
Converse Nadelhalter, TC	145	Endoskope zur endolaryngealen Mikrochirurgie	3
Nasenflügelhaken	314	Endoskope, -Zubehör	2-7, 422
Nasenplastikmesser	288	Endoskopsiebkörbe	422
Osteotome	297, 298	Erhard Ohrspekula	186
Cordes Zangenaufsätze	408	Ersatzteile und Zubehör für Kauter	37
Cottle Anatomische Pinzetten	79, 255	Ersatzteile und Zubehör für Stirnspiegel, Stirnlampen	119-123
Columellapinzetten	88, 257, 314	Etui für Nystagmus-Brillen	172
Häkchen	311, 313	Eves Tonsillenschnürer	342
Hämmer	139, 182, 302	Ewald Anatomische Pinzetten	79
Nasenflügelhaken	314	Exartikulations-Instrument	216
Nasenpinzetten	257	F. O.-Otoskope	114, 116
Nasenplastikmesser	289	Fadenführer	310
Nasenraspeln	307	Fadengabel	237, 310, 336
Nasenscheren, -SUPERCUT, -TC	58, 249	Falk Tonsillennadeln	336
Nasenspekula	269	Farabeuf Raspatorien	133, 177
Ohr- und Nasenpinzetten	87	Wundhaken	95
Osteotome	299, 300	Farell (Farell-Lathbury) Watteträger	113, 171
Septum-Elevatorien	291, 293, 295	Farrior Ohrspekula	185
Septummeißel	300	Fasspinzetten	80, 82, 257
Cottle-Masing Nasenscheren	56, 248	Fasszangen	78, 281, 340, 341, 354, 361, 363, 364
Cottle-Neivert Häkchen	313	Faulkner Kieferhöhlenküretten	371
Cottle-Walter Nasenspekula	269	Kieferhöhlenmeißel	370
Craig (-Domnick) Polypenzangen	278	Fein Watteträger	110, 405
Crile (-Rankin) Arterienklemmen	69, 70, 253	Feine chirurgische Scheren	47-49
Crile-Wood Nadelhalter	142, 144	Feine Pinzetten	85, 256
Cushing Wund- und Nervhäkchen	89	Feine Scheren, -SUPERCUT, -TC	50, 61-64, 162, 164, 246, 250-252
Daniels Tonsillotome	344	Fergusson Spül- und Saugrohre	151, 198, 375
Davis-Boyle Mundsperrer	327	Fergusson-Ackland Mundsperrer	331
Davis-Meyer Mundsperrer	325	Ferris-Smith Septumzangen	281
Day Ohrhäkchen	237	Ferris-Smith-Kerrison Kieferhöhlenstanzen	365
De Bakey Atraumatische Pinzetten	86, 256	Fiberglas-Lichtträger für Laryngoskope	394
Bulldogklemmen	77	Filter für Container	423-428
Nadelhalter, TC	144	Fingerschützer	334
De Bakey-Hess Bulldogklemmen	77	Fino Feine Scheren	61, 164, 250, 251
Denhart Mundsperrer	330	Finsen Wundsperrer	99
Derlacki Chirurgische Pinzetten	84, 165	Fisch Dissektoren	229
Deschamps (-Standard) Unterbindungsadeln	148, 149	Kieferhöhlensperrer	352
Diagnostik-Sets	114-116	Messinstrumente	230
Dieter Hammerkopfstanzanzen	204, 218	Messzylinder	230
Dilatationssonden	373	Fisch Mikrohäkchen	226
Dilatatoren	111, 378	Neurektomie-Messer	225
Dingmann Mundsperrer	326	Perforatorien	227
Dissektoren	216, 229, 230	Saugrohre	198
Donaldson Paukenröhrchen	210	Tenotome	225
Doppelöffelzangen	362	Wundsperrer	101, 169, 352
Doyen-Collin Mundsperrer	330	Fischer Tonsillennmesser	337
Drahtbiegezängchen	204, 208, 218	Fistelmesser	109
Drahtscheren, -TC	65, 164	Flachmeißel	129, 130, 173, 297-300
Drahtschlingen-Elektroden	30	Flexible Zangen	7
Drahtschneide- und Biegezange	138	Fomon Nasenflügelhaken	312, 313
Duplay Korn-(Polypen)Zangen	76	Nasenraspeln	304, 305, 308
Tamponzangen	337	Nasenscheren, -SUPERCUT	57, 58, 248, 249
Eicken Raspatorien	178	Ritzmesser	289
Eicken (-Killian) Spülkanülen	373	Septummeißel	300
Einführungsinstrument für Paukenröhrchen	209	Formby Löffel	237

INHALTSVERZEICHNIS

Fowler Tonsillennmesser	337	Guastella-Ey Septummeißel.....	301
Fraenkel Kehlkopfzangen, -fremdkörperzangen	410, 411	Gummibinde elastisch, für Neutralelektroden	26
Zangenaufsätze.....	408	Gummi-Neutralelektroden	26
Fräser	159	Guthrie Hauthäkchen.....	90
Frazier Absaugrohre	151	Hajak Conchotome	285
Hauthäkchen	309	Hämmer	139, 183
Wund- und Nervhäkchen	89	Septumzangen	354
Freeman (-Gorney) Präparierscheren, SUPERCUT	52, 53	Wundhaken	95
Freeman-Kaye Präparierscheren, SUPERCUT	52	Hajak (Hajak-Kofler) Keilbein-, Kieferhöhlenstanzen	287, 368
Freer Hohlmeißel.....	297	Hajak-Ballenger Septum-Elevatorien	292
Nasenplastikmesser	289	Häkchen,	
Osteotome	297	Dura-	309
Raspatorien	294	für Ohrbesteck	239
Ritzmesser	289	Gefäß-	310, 311
Schleimhauthaken	312	Haut-	90, 92, 309
Freer (-Joseph) Septum-Elevatorien	291–294	Mikrochirurgie-	226–230
Freer-USA Mod. Septum-Elevatorien	292	Nasenflügel-	311–314
Freer-Yasargil Septum-Elevatorien	292	Nerv-	89
Fremdkörperheber	200, 237	Ohr-	239
French Hartmann Stimmgabeln	190	Ohrlöffel-	237
Frenzel Nystagmus-Brillen	172	Schleimhaut-	312
Zungenspatel.....	333	Tracheal-	90–93
Friedmann (-Delikat) Hohlmeißelzangen	135, 179	Tränensack-	309
Frohn Watteträger	112, 259	Wund-	89–93
Führungsgabeln	230, 336	Haken,	
Führungshohlsonden	150	Doppel-	316
Führungsnadeln	127	Kieferhöhlen-	227, 321, 350
Gallaher Nasenraspeln	308	Nasen	315
Gaumenplatten	325	Nasenflügel-	311–314
Gefäßhäkchen	310	Schilddrüsen-	379
Gerald Chirurgische Pinzetten	84	Stapedektomie, Stapedotomie	216
Mikropinzetten	82	Tracheal-	90–93, 379
Gerzog-Sexton Messer	238	Wund-	93–98, 312, 316, 321, 350
Gestell für Ohrzängchen	208	Halle Nasenscheren	58, 249
Gewebekralle	310	Scharfe Löffel	367
Gillies Chirurgische Pinzetten	84	Septum-Elevatorien	291
Hauthäkchen	309	Halsey Nadelhalter, TC	145
Wund- und Nervhäkchen	89	Halsted-Mosquito Arterienklemmen	71, 253
Glasfaser-Lichtleitkabel	8	Hämmer	138, 139, 182, 183, 302
Glasschalen	430	Hammerkopfstanzn	204, 218
Glatzel Nasenspiegel	276	Handgriff für Laryngoskopie-Instrumente	404
Glomus-Spreizer	169	Handstücke für Motorsystem	155
Goldmann Nasenfrakturaufrichter	316	Handwaschbürsten	421
Goldmann-Fox Scheren, TC	67	Hartmann Arterienklemmen	72
Good Tonsillenscheren	55, 320	Hartmann Conchotome	285
Gorney Scheren, Präparierscheren, SUPERCUT	53, 163	Häkchen	237
Graefe Chirurgische Pinzetten	88	Kiefer- und Stirnhöhlen-Spülkanülen	372
Fasspinzetten	257	Ohrspekula	186, 187
Feine Scheren	63, 252	Saugrohre	195
Graefe Hauthäkchen	90, 309	Septumzangen	277
Greven Mikro-Ohrzängchen	204	Stimmgabeln	190
Griffe Batterie-,		Tonsillen-Conchotome	345
für Laryngoskope	384–391	Watteträger	110
für Otoskope	114–117	Zungenspatel	333
Griffe,		Hartmann (Citelli) Ohrzängchen	200–202
Elektroden-Hand-	21–24	Hartmann (-Halle) Nasenspekula	261, 262
für Kehlkopfspiegel	409	Hartmann-Noyes Ohrzängchen	201
für Ohrbesteck	239	Hartmann-Weingärtner Ohrzängchen	202
für Stabinstrumente	404	Hartmann-Wullstein Ohrzängchen	202
Kauter-	36	Harvey Verbandscheren	66
für Laryngoskopie, Universal	384, 389	Haslinger Tonsillenelevatorien	340
Sinuskop-Hand-	10	Hauthaken	90, 92, 309
Skalp-	104, 105, 107, 108	Heanley Hohlmeißelzangen	179
Gross Küretten	237	Heermann Hämmer	139, 182
Gross-Maier Korn-(Polypen) Zangen	76	Pinzettenzängchen	217
Gruber Ohrspekula	187	Hegar-Baumgartner Nadelhalter, TC	143
Grünwald (-Henke) Conchotome	285	Henke Elevatorien	339

INHALTSVERZEICHNIS

Henley Wundsperrerr	102	Kehlkopf-	126
Herberhold Zungenspatel	328	Koagulations-	402
Heymann Nasenscheren, -SUPERCUT	55, 247	Saug- und Spül-	125, 152, 372–375, 402
Heymann-Knight Septumzangen	277	Septum-	126, 375
Hohlmeißel	129, 130, 173, 174, 297, 302	Tonsillen-	126
Hohlmeißel-Zangen	135–138, 179, 180	Katheterzangen	128
Höhm Spiegel	231	Kauter	36
Holinger Laryngoskope	394	Kauter, Akku	37
Hörschlauch	240	Kazanjian Septumschere	286
House Mess-Sonden	229	Kehldeckelhalter	411
Mikrolöffel	232	Kehlkopf-Fremdkörperzangen	410
House-Gelfoam Quetschzange	233	-Kanülen	126
House (Fisch) Saugadapter	195	-Spiegel	409
Saugrohre	197	-Zangen	410, 411
Howarth Septum-Elevatorien	292	Keilbeinstanzen	287, 368
HTT-Kabel	8	Kelly (-Rankin) Arterienklemmen	69
Huber Universalgriffe	407	Kerrison Keilbeinstanzen	287
Hughes Steigbügelhäkchen	230	Kieferhöhlenstanzen	368
Humby Wund- und Trachealhäkchen	91	Knochenstanzen	184
Hurd Elevatorien	338	Kiefer- und Stirnhöhlen-Spülkanülen	372
Tonsillennadeln	335	Kieferhöhlen-	
Injektionskanülen	126, 394, 403	Elevatorien	371
Instrumentarium für Paukenröhrchen	209	Fasszangen	361
Instrumentenkassetten	424–427	Haken	321, 350
Instrumentenöl	421	Häkchen	227
Intubationsrohre	378	Küretten	371
Iterson Trachealhäkchen	92	Löffel	369
Jackson Laryngoskope	394	Meißel	370
Wund- und Trachealhäkchen	91, 92	Punktionstrokare	374
Jacobson Scharfe Löffel	132, 176	Raspeln	370
Jacobson-Adson Anatomische Pinzetten	79	Sperrerr	100, 101, 351, 352
Jacobson-Halsted Arterienklemmen	72	Kieferhöhlen-	
Jameson (-Werber) Feine chirurg. Scheren, -SUPERCUT	49, 246	Stanzen	358, 359, 365, 368
Jansen Hohlmeißelzangen	136, 137, 179	Killian Laryngofissur-Schere	411
Jansen Hörschlauch	240	Nasensonden	258
Löffel	236	Septum-Elevatorien	293
Raspatorien	133, 177, 178	Killian Sonden	110, 373
Scharfe Löffel	132, 176	Watteträger	405
Stirnlampen	122	Killian (-Claus) Septummeißel	299
Jansen (-Fine) Nasenpinzetten	88, 257, 276	Killian-Struycken Nasenspekula	264–268, 271, 272
Jansen (-Gruenwald) Nasenpinzetten	88, 257, 276	Killian-Walter Nasenspekula	268
Ohrpinzetten	166	Kilner Hauthäkchen	309
Jansen Wundsperrerr	99, 167	Nasenflügelhaken	314
Jennings Mundsperrerr	331	Nasenschere	56, 248
Jobson-Horne Watteträger	112, 171	Wund- und Nervhäkchen	89
Jones Tuchklemmen	75	Wundhaken	95
Joseph Feine Scheren	50, 246	Kilner (Ragnell) Feine Scheren, Präparierschere, -TC	51, 246
Nasenplastikmesser	288, 289	Kilner-Doughty Mundsperrerr	324
Nasenraspeln	306	Kirstein Nasenschere	56, 247
Nasensägen	303	Kleinert-Kutz Wundhäkchen	90
Periost-Elevatorien	295	Kleinert-Kutz (Fomon) Nasenraspeln	308
Raspatorien	133	Klemmen,	
Scheren	162	Arterien-	68–74, 253
Schleimhauthaken	312	Atraumata-Arterien-	71
Septum-Elevatorien	291	Bulldog-	77, 87
Joseph (Cottle) Masing Elevatorien	295	Ligatur-	70
Jurasz Kehlkopfzangen	411	Sinus-	76, 254, 276, 364
Scharfe Nasenzangen	288	Tonsillen-	73–75, 341
Kabel, bipolar und monopolar	27–29	Tuch-	75
Kabierske Pulverbläser	240	Kley Ohrsonden	170
Kaltlichtkabel	8	Klingen, Rasier-	109
Kaltlichtkabel-Adapter	9	Skalpell-	106, 107
Kaltlichtlaryngoskope	389–391	Knapp Häkchen	309
Kaltlicht-Stirnlampen	121, 123	Knochen-Knorpelquetsche	308
Kanülen,		Knochensplitterzangen	138, 181
Aspirations-	125	Knochenstanzen, -ProClean	184, 366
Injektions-	126, 394, 403	Knopfsonden	110, 222, 239

INHALTSVERZEICHNIS

Kocher Arterienklemmen.....	68
Sonden.....	379
Kocher-Langenbeck Wundhaken.....	97, 98
König Elevatorien.....	135, 178
Führungshohlsonden.....	150
Korn-(Polypen) Zangen.....	76
Krause Zangenaufsätze.....	408
Krause (-Voss) Polypenschnürer.....	199, 273
Kressner Septumrichtzangen.....	318
Kroenig Zungenspatel.....	333
Kronecker Unterbindungsnadeln.....	149
Kropffasszangen.....	78
Kugel-Elektroden, -bipolar.....	30, 34, 35
Kuhn-Bolger Kieferhöhlenlöffel.....	369
Kunststoffbehälter für Endoskope.....	422
Küretten.....	131, 175, 176, 216, 229–237, 239, 371
La Force Adenotome.....	323
Laborde Trachealdilatatoren.....	378
Lahey Kropffasszangen.....	78
Landolt Skalpellgriffe für Miniklingen.....	108
Lange Häkchen.....	311
Langenbeck Elevatorien.....	134
Fingerschützer.....	334
Küretten.....	236
Nadelhalter, TC.....	146
Wundhaken.....	97, 98
Langenbeck-Green Wundhaken.....	94
Lange-Wilde Polypenschnürer.....	199, 273
Lanzettenelektroden.....	30
Lanzettenmesser.....	225
Lärmtrommeln.....	194
Laryngo-Broncho-Oesophagoskopie-Zangen.....	414–416
Laryngofissur-Scheren.....	411
Laryngoskope.....	2, 385–395
Laryngoskopgriffe.....	384, 389
Laryngoskopie-Schnürer.....	403
Laryngoskopie-Stabinstrumente.....	404
Laryngoskop-Zubehör.....	384, 389
Lazar Anatomische Pinzetten.....	165
Mikropinzetten.....	82
Lempert Hohlmeißelzangen.....	136, 179
Messer.....	238
Raspatorien.....	133, 231
Scharfe Löffel.....	131, 175
Leriche Arterienklemmen.....	70
Lewis Nasenraspeln.....	307
Lexer Scheren, -SUPERCUT, -TC.....	42
Lichtenberg Nadelhalter, TC.....	146
Lichtwitz Sinuskopie-Trokare.....	374
Trokare.....	125
Ligaturinstrumente.....	336
Ligaturklemmen.....	70
Ligaturscheren.....	65
Lindemann Nasensägen.....	303
Lineale.....	113, 260
Lippen- und Wangenhalter.....	103, 351
Lister Sinusklemmen.....	76, 254, 276
Verbandscheren.....	66
Littauer Ligaturscheren.....	65
Ohrzängchen.....	200
Löffel,	
Kieferhöhlen-.....	369, 371
Mikro-.....	229, 232
Ohr-.....	239
scharf.....	131, 132, 175, 176, 222, 367
Stapedektomie-.....	232
Löffel.....	236, 237
Löffelzangen, -zängchen.....	201, 202, 204, 207, 217
.....	219, 221, 279, 358, 362
Lopez-Reinke Elevatorien.....	339
Love Elevatorien.....	339
Lubet-Barbon Nasentamponzangen.....	277
Luc Septumzangen.....	278
Lucae Hämmer.....	183
Knopfhäkchen.....	237
Messer.....	239
Ohr- und Nasenpinzetten.....	87, 166
Parazentesenadeln.....	239
Stimmgabeln.....	190
Lucas Flachmeißel.....	129, 173
Hohlmeißel.....	129, 173
Osteotome.....	129
Luer Haken.....	316
Hohlmeißelzangen.....	137, 180
Wundhaken.....	93
Luftdusche.....	240
Lukens Wund- und Trachealhäkchen.....	91
Luniatschek Tamponstopfer.....	335
Lupenbrillen.....	118
Magill Katheterzangen.....	128
Maltz Nasenplastikmesser.....	289
Maltz Nasenraspeln, TC.....	304–306
Maniküre-Sets.....	420
Marschik Chirurgische Pinzetten.....	84
Martini Scharfe Löffel.....	132, 176
Masing Elevatorien.....	295
Meißel.....	302
Masing Nasenflügelhaken.....	314
Ritzmesser.....	289
Masing (Silver) Septummeißel.....	301
Mathieu Nadelhalter, -TC.....	146
Mayo Scheren, -TC.....	43
Zungenspatel.....	333
Mayo-Hegar Nadelhalter.....	142, 143
Mc Donald Elevatorien.....	135, 294
Mc Gee Drahtbiegezängchen.....	204, 218
Mikrohäkchen.....	227
Mc Gee/Fisch Drahtbiegezängchen.....	208
Mc Indoe Anatomische Pinzetten.....	80
Chirurgische Pinzetten.....	84
Meißel.....	302
Präparierscheren.....	53
Mc Intosh Laryngoskope.....	385
Fiber-Optic Kaltlichtlaryngoskope.....	389, 390
Mc Ivor Mundsperrer.....	328
Mc Kenty Septum-Elevatorien.....	291, 292
Mead Hämmer.....	183
Hohlmeißelzangen.....	136
Medizinbecher.....	430
Meißel,	
Flach-.....	129, 130, 173, 297–300
Hohl-.....	129, 130, 173, 174, 297, 302
Kieferhöhlen-.....	370
Mikro-Flach-.....	233
Mikro-Hohl-.....	233
Septum-.....	297, 299–301
Messer,	
Chirurgisches, für Stapedektomie, Stapedotomie.....	216
Fistel-.....	109
Lanzetten-, Mikrochirurgie.....	225
Longitudinal-, für Stapedektomie, Stapedotomie.....	216
Mikrochirurgie-.....	222–239
Nasenplastik-.....	288, 289
Periost-.....	178

INHALTSVERZEICHNIS

Ring-.....	321–323	Mosquito-Dandy Arterienklemmen.....	73
Roll-, Mikrochirurgie.....	222	Motorsystem.....	154
Rundschnitt, Mikrochirurgie.....	216, 224, 225	Mundsperrerr.....	324–328, 330–332
Septum-.....	290	Murphy Stirnbänder.....	119
Sichel-.....	239, 369	Museux Tonsillenfasszangen.....	340
Tonsillen-.....	337, 338	Musgrove Häkchen.....	237
Messer-Elektroden.....	30	Myles Conchotome.....	285
Messinstrument für Stapedektomie + Tympanoplastik, mikrochirurgisch.....	209	Myles Septumzangen.....	354
Messinstrumente.....	216, 229, 230	Myringotome.....	239
Mess-Sonden.....	229, 230	Nadeldosen.....	429
Messzylinder.....	230	Nadel-Elektroden, - bipolar.....	30
Metallständer für Ohrspekula.....	187	Nadelhalter, TC.....	141–147
Metalltablett.....	308	Nadeln, Chirurgische.....	140
Metzenbaum (-Fino) Präparierscheren, -SUPERCUT, -TC.....	44–47, 162, 244, 245, 320	Führungs-.....	127
Meyerdig Wundhäkchen.....	92	Mikro-.....	226–229
Michel Kehlkopfspiegel.....	409	Parazentese-.....	239
Micro-Adson Anatomische Pinzetten.....	79	Stapedektomie, Stapedotomie.....	216
Micro-Adson (-Biemer) Chirurgische Pinzetten, -TC.....	83, 255	Tonsillen-.....	335, 336
Micro-Mosquito Arterienklemmen.....	72	Trommelfell-.....	239
Micro-Ryder Nadelhalter, TC.....	145	Unterbindungs-.....	148, 149
Middeldorpf Wundhaken.....	98, 321, 350	Nadelsauger.....	197
Middleton-Jansen Septumzangen.....	286	Nagelfeilen.....	420
Mikro-.....		Nagelscheren.....	67
Chirurgisches Messinstrument.....	209, 216	Nagelzangen.....	420
Häkchen.....	216, 226–228	Nager Elevatorien.....	339
Lanzettenmesser.....	225	Tonsillennadeln.....	335
Löffel.....	229, 232	Nasen-.....	
Löffelzängchen.....	204, 207, 217, 219, 221	Flügelhaken.....	312–314
Messer.....	222–233	Frakturaufrichter.....	316
Motor.....	154	Pinzetten.....	87, 88, 257, 276
Nadelhalter.....	141	Plastikmesser.....	288, 289
Nadeln.....	226–229	Rachen – Probeexcisionszangen.....	357
Ohrscheren.....	205, 207, 208, 217, 218, 221	Rachenzangen.....	363
Ohrzängchen.....	203, 204, 206–208, 217, 219–221	Raspeln, -TC.....	304–308
Pinzetten.....	81, 82	Sägen.....	303
Rollmesser.....	222	Scheren, -TC, -SUPERCUT.....	55–58, 247–249, 363
Rundschnittmesser, Mikrochirurgie.....	224, 225	Sonden.....	258
Sägen oszillierend, für Motorsystem.....	156	Spekula.....	261–272
Scheren.....	59, 60, 163, 217, 218, 221, 358	Spiegel.....	276
Stanzen.....	359	Stanzen.....	361
Stichsägen, für Motorsystem.....	156	Tamponzangen.....	277
Zängchen.....	357, 358	Zangen.....	288, 353
Mikrochirurgie.....	222–233	Nasopharyngoskope.....	6
Mikulicz Tonsillenklemmen.....	74, 75	Negus Fadengabeln.....	336
Miller Laryngoskope.....	388	Laryngoskope.....	387
Nasenraspeln, -TC.....	305, 306	Ringmesser.....	321
Scharfe Löffel.....	176	Tonsillenklemmen.....	74
Fiber-Optic Kaltlichtlaryngoskope.....	391	Neivert Häkchen.....	313
Millesi Mikroscheren.....	60, 163	Nadelhalter, TC.....	143
Mini-Lambotte Osteotome.....	130, 298	Neivert (Masing) Septummeißel.....	301
Mini-Lexer Hohlmeißel, Osteotome.....	130, 174	Nervhäkchen.....	89
Mittelohr-Implantate.....		Nervpräparierscheren.....	53
Mod. Rudolf Kieferhöhlenstanzen.....	359	Netzgerät für Thermokaustik.....	36
Scheren, Präparierscheren, -SUPERCUT.....	40, 41, 51	Neurektomie-Messer.....	225
Verbandscheren.....	66	Neutralelektroden, Zubehör.....	26
Watteträger.....	113	Nierenschalen.....	241, 429
Mod. USA Chirurgische Pinzetten.....	83	Northbent Ligaturscheren.....	65
Mod. Wien Nasenspekula.....	263	Nystagmus-Brillen.....	172
Modell Würzburg Zungenspatel.....	328	Ochsner-Kocher Arterienklemmen.....	68
Mollison Wundsperrerr.....	102	O'Connor Hauthäkchen.....	90
Molt Raspatorien.....	133	Ohr-.....	
Monopolare Elektroden.....	30	Haken.....	237
Monopolare Kabel, Sicherheitskabel.....	27	Küretten.....	239
Moritz-Schmidt Zungendrucker.....	332	Löffel.....	239
Mosquito Atrauma-Arterienklemme.....	71	Nadeln.....	226
		Pinzetten.....	87, 166

INHALTSVERZEICHNIS

Sonden	170, 239	Mikrohäkchen	226, 230
Spekula	185–189	Mikromesser	223
Spritzen	241, 242	Saugrohre	198
Zängchen	200–203	Plester Schaber	230
Ollier Wundhaken	97	Plester-Helms Wundsperrer	168
Olsen-Hegar Nadelhalter, TC	147	Politzer Luftdusche	240
Ölspray	421	Messer	238
Operationslaryngoskope	392–395	Myringotome	239
Optische Zangen	4	Ohrspekula	185
Oropharyngealtuben	379	Parazentesenadeln	239
Osteotome	129, 130, 173, 174, 297–302	Polypen-/Kornzangen	76
Otoskope BETA 100, BETA 200	2, 114–116	Polypenschlingen	199
Paparella Paukenröhrchen	211	-Schnürer	199, 273
Parazentesenadeln	239	-Schnürerdraht	273
Parkes Höcker-Hohlmeißel	302	-Zangen	76, 278
Nasenraspeln	304	Potts-Smith Anatomische Pinzetten, TC	82
Partsch Flachmeißel, Hohlmeißel	129, 173	Präparier-	
Passow Stößel	130, 174	Sauger	152
Paukenröhrchen, kurzzeitige Anwendung		Scheren, -TC	41–47, 51–53, 63, 162, 163, 244, 245, 252, 320
Donaldson	210	Tabletts	231, 308
Shepard Grommet	210	Pravaz Kanülen	126
Paukenröhrchen, langfristige Anwendung		Prince Tonsillenscheren	54
Paparella	211	Probeexcisions- und Fasszangen	357, 364
T-förmig	211	ProClean ® Knochenstanzen	366
Tuebinger	211	Providence Arterienklemmen	70, 253
Paukenröhrchen, mittelfristige Anwendung		Prüfinstrumente	260
Collar Button	210	Pulverbläser und Zubehör	240
Reuter Bobbin	210	Quervain Elevatorien	134, 178
Péan Arterienklemmen	68	Quetschzange	233
Pelteson Watteträger	110, 405	Quinby Zahnfleischscheren	67
Pennington Elevatorien	294	Quire Fremdkörperheber	200
Perforatorien	227	Ragnell-Davis Haken	316
für Stapedektomie, Stapedotomie	216	Wundhaken	94
Periost-Elevatorien	295	Rasierklängen	109
Perkins Kieferhöhlensperrerr	100, 351	Rasierklängenhalter	109
Perwitzschky Tonsillenmesser	337	Raspatorien – Mikrochirurgie	222
Petri-Doppelschalen	429	Raspatorien	133, 134, 152, 177, 178, 229, 231, 294, 404
Pflasterspatel	110	Raspeln	304–308, 370
Pflegefett für Hähne	421	Rauchabsaugrohre	394
Pflegeprodukte	421	Redon-Führungsnadeln	127
Pharyngoskope	5	Regensburg Spiegel	231
Piccolo Watteträger	171	Reichert Kehldeckelhalter	411
Pierce Elevatorien	294	Reinigungsbürsten	419
Trokare	125	Reinigungsfluid für Optiken	421
Pinzetten,		Reinigungspistolen, -zubehör	418, 419
Anatomisch, - TC	79–82, 165, 255	Reinigungsspray	155
Atraumatisch	86, 87, 256	Reinigungszubehör	155, 418, 419
Bipolar, - TC	16–19	Reinigungsaufsätze für Reinigungspistolen	419
Chirurgisch, - TC	83, 84, 88, 165, 255	Repositionszangen	317
Columella-	88, 257, 314	Reuter Bobbin Paukenröhrchen	210
Fass-	257	Reynolds Feine chirurg. Scheren, SUPERCUT	49
Fein-	85, 256	Präparierscheren, SUPERCUT	52
Mikro-	81, 82	Ringmesser	321–323
Nasen-	87, 88, 257, 276	Ritter-Halle Dilatationssonden	373
Ohr-	87, 166	Ritzmesser	289
Splitter-	86	Rochester-Péan Arterienklemmen	68
Tumorfass-	80, 82	Roeder Ligaturinstrumente	336
Uhrmacher	85	Rogge Abfallzangen	420
Pinzettenzängchen	217	Rollet Tränensackhäkchen	309
Plastische Chirurgie		Rollmesser, Mikrochirurgie	222
Feine Scheren, SUPERCUT	47	Ronis Nasenrachen-Probexcisionszangen	357
Platten-Elektroden	30	Rose Wundhaken	93
Plester Absaugrohre	151	Rosen Elevatorien	229
Führungsgabeln	230	Lanzettenmesser	225
Häkchen	227	Mikrolöffel	229
Kieferhöhlenhäkchen	227	Mikromesser	224, 225
Kieferhöhlensperrerr	352	Mikronadeln	226, 228, 229

INHALTSVERZEICHNIS

Rosen Raspatorien	229	Seibeleu Elevatorien	135, 178
Rosen (House) Saugrohre	197	Seemann-Seiffert (Standard) Mundsperrerr	332
Roser-König Mundsperrerr	330	Sehnenmesser	225
Racks	428	Sehnenscheren	251
Roux Wundhaken	94	Seiffert Ohrsonden	170
Rowe Repositionszangen	317	Speichelgangsonden	111
Rubin Osteotome	301	Zangenaufsätze	408
Septumrichtzangen	318	Semken Anatomische Pinzetten, -TC	80, 165
Rudolf Ölspray	421	Chirurgische Pinzetten	84, 165
Rudolf Care Instrumentenöl	421	Senning Nadelhalter	142
Rudolf (Swedish Pattern) Nadelhalter, TC	145	Senn-Miller Haken	316
Rundschnittmesser	224, 225	Wundhaken	93
Ruskin Hohlmeißelzangen	138	Septum-	
Rydel-Seiffer Stimmgabeln	191	Elevatorien	291–293, 316
Ryder Nadelhalter, TC	145	Kanülen	126, 375
Sage Tonsillenschnürer	343	Meißel	299–302
Sägen	156, 303	Messer	290
Sägeblätter für Motorystem	156	Scheren	286
Sarot Nadelhalter, TC	146	Zangen, -richtzangen	277–279, 281, 286, 317, 318, 354
Saug- und Spülkanülen	125, 151, 152, 372, 373, 375, 402	Sevall Elevatorien	135
Saugadapter	195	Kieferhöhlenelevatorien	371
Saugkanülen, Laryngoskopie	402	Sexton Messer	238
Saugraspatorien	152, 404	Shambaugh Adenotome	323
Saugrohre	151, 152, 195–198	Mikrohäkchen	226
Schaber, Mikro-	230	Shapleigh Küretten	236
Schädel Tuchklemmen	75	Shea Mikro-Löffel	232
Scharfe Löffel	131, 132, 175, 176, 367	Mikro-Ohrscheren	205
Scharfe Nasenzangen	288	Sheehan (Rubin) Osteotome	298
Scheinmann Zangenaufsätze	408	Shepard Grommet Paukenröhrchen	210
Scheren,		Sichelmesser	239, 369
Chirurgisch, -TC	40–43, 47–49	Sicherheitskabel, monopolar	27
Crurotomie-	208	Sichtschutzvisier für Lupenbrille	118
Draht-	65, 164	Siebbeinzangen	280–284, 355, 356
Feine chirurgische, -TC	47–50, 61–64, 162, 164, 246, 250–252	Siebbeinzangen Rudolf ProClean	282, 355
Ligatur-	65	Siebenmann Dilatatoren	111
Mikro-	59, 60, 163, 207, 208, 217, 218, 221, 358	Stopfer	258
Mikro-Ohr-	205–208	Siebkörbe	422, 423
Nagel-	67	Siegle Ohrspekula	188
Nasen-	55–58, 247–249, 363	Silikon-Folien für medizinische Zwecke	211
Plastische Chirurgie	47	Simon Fistelmesser	109
Präparier-, -TC	42–47, 51–53, 63, 162, 163, 244, 245, 252, 320	Sinusklemmen	76, 254, 276, 364
Sehnen-	251	Sinuskope	4
Septum-	286	Sinuskop-Handgriffe	10
Speichelgang-	53, 320	Sinuskopie-Trokare	374
Strabismus-	63	Sinuskop-Schäfte	10
SUPER-CUT	42–53, 55–58, 62–64, 163	Skalpelli-Griffe	104, 105, 107, 108
TC	40–67, 162, 164, 244–252, 320	für Miniklingen	108
Tonsillen-	54, 55, 320	Skalpelli-Klingen	106, 107
Verband-	66	Skalpelli-Miniklingen	107
Schilddrüsenhaken	379	Sluder-Ballenger Tonsillotome	344
Schleimhauthaken	312	Snellen Küretten	236
Schlingen	236, 237	Sonden, Dilatations-	373
Schmeden Conchotome	285	Führungshohl-	150
Schmidt Tonsillenklemmen, -klemmzangen	73, 341	Hohl-	110, 150
Schnürdraht und -Schlingen für Polypenschnürer	199	Knopf-	110, 222, 239
für Tonsillenschnürer	343	Kropf-	379
Schoenborn Schilddrüsenhaken	379	Mess-	229, 230
Schuknecht		Myrtenblatt-	110
Biegegerät	233	Nasen-	258
Drahtbiegezängchen	204	Ohr-	170, 239
Mikromesser	222	Speichelgang-	111
Saugrohre, Nadelsauger	197	Sonden	110, 111
Schuknecht		Spannarm, flexibel, für Nasenspekula	270
Scheren	164	Spannungsquellen für Stirnlampen	124
Schumacher Zangenaufsätze	408	Speichelgangsscheren	53, 320
Schutzhülse für Mikro-Instrumente	208	Speichelgangsonden	111
Schutzhülsen für Optiken		Spekula, Ohr-	185–189

INHALTSVERZEICHNIS

Spencer Ligaturscheren	65	Tenotome	225
Sperrer, Kieferhöhlen-	100, 351, 352	Textilfilter für Container	423–428
Mund-	324–332	Thies Flachmeißel, Hohlmeißel	173
Wund-	99–103, 167–169, 378	Thilenius Tonsillenabszetzangen	337
Spiegel,		Thudichum Nasenspekula	272
Kehlkopf-	409	Tieck Nasenspekula	262
Mikro-	231	Tilley Nasentamponzangen	277
Nasen-	276	Ohrzängchen	200
Stirn-	119	Tobold Zungenspatel	333
Spirituslampen	429	Tönnis (-Adson) Tonsillenscheren, -TC	54
Splitter-Pinzetten	86	Tonsillen-	
Spratt Scharfe Löffel	131	Abszesszangen	337
Spreizer, Glomus-	169	Conchotome	345
Spritzen,		Elevatoren	340
Dreiring-	127	Fasszangen	340, 341
Injektions-	127	Kanülen	126
Ohr-	241, 242	Klemmen, Klemmzangen	73–75, 341
Spül- und Saugrohre	151, 195–198	Messer	337, 338
Spülkanülen	125, 372, 373	Nadeln	335, 336
St. Clair-Thompson Ringmesser	322	Scheren, -TC	54, 55, 320
Stacke (-Frenzel) Sonden, Ohrsonden	110, 170	Schnürer	342, 343
Standard Anatomische Pinzetten, -TC	79	Tonsillotome	344
Chirurgische Pinzetten	83	Toynbee Ohrspekula	186
Feine Scheren	62	Tracheal-	
Scheren, -TC	40, 41	Dilatatoren	378
Wund- und Trachealhäkchen	91	Haken	90–93, 379
Standard-Grazil Scheren	42	Sperrer	378
Standgefäße	430	Trokare	379
Stanzen,		Tränensackhäkchen	309
Hammerkopf-	204, 218	Transformatoren	36, 124
Keilbein-	287, 368	Transplantat-Träger	230
Kieferhöhlen-	358, 359, 365, 368	Troeltsch (-Wilde) Ohr- und Nasenpinzetten	87, 166, 276
Knochen-	184, 366	Trokare,	
Mikro-	359	Sinuskopie-	374
Nasen-	361	Tracheal-	379
Stirnhöhlen-	364	Trokare	125
Zirkular-	360	Trommelfellmesser	239
Stapedektomie-Löffel	232	Trommelfellnadeln	239
Steckernetzteile für Stirnlampen	124	Trousseau-Baby Trachealdilatatoren	378
Steigbügelhäkchen	230	Tubeninstrumentarium	209–216
Sterilisationszubehör für Endoskope	422	Tuchklemmen	75
Sternberg Wangen- und Lippenhalter	351	Tuebinger Paukenröhrchen	211
Zungendrucker	332	Tumorfass-Pinzetten	80, 82
Stevens Feine Scheren, -SUPERCUT	63	Tyding Tonsillenschnürer	342
Sehnenscheren	251	Uckermann Trachealtrokare	379
Stimmgabeln, Bestecke	191–193	Uffendorde Scharfe Löffel	132, 367
Stirnbänder	119	Uhrmacherpinzetten	85
Stirnhöhlenstanzen	364	Ulrich Korn-(Polypen)Zangen	76
Stirnlampen	120–123	Universal Drahtscheren, -TC	65
Stirnspiegel	119	Universal Verbandscheren	66
Stopfer	258	Watteträger	112, 171, 259
Stößel	130, 174	Universalgriffe	407
Strabismusscheren, -TC	63, 64	Unterbindungsnadeln	148, 149
Stromquellen für Otoskope	116	Venen-Dissektor	216
Strümpel (-Voss) Nasenzangen	353	Verbandscheren	66
Strümpel (-Voss) Ohrzängchen	202	Volkman Scharfe Löffel	131, 175
Septumzangen	279	Trachealhäkchen	93
Struycken Conchotome	285	Wundhaken	96
Septumzangen	354	Wagener Knopfhäkchen	237
SUPERCUT-Scheren	42–53, 55, 57, 58, 62–64, 163	Wagner Feine Scheren	48, 246
Tabb Mikromesser	222	Walsham Septumrichtzangen	317
Takahashi Nasenzangen	353	Walter Nasenfrakturaufrichter	316
Nasenzangen ProClean	353	Osteotome	300
Siebbeinzangen	280	Septummeißel	300
Siebbeinzangen ProClean	280	Wangen- und Lippenhalter	103, 351
Tamponstopfer	335	Watson-Williams Septumzangen	354
Tamponzangen	277, 337	Siebbeinzangen	280, 281

INHALTSVERZEICHNIS

Watteträger.....	110–113, 171, 259, 405, 416	Zungen-.....	334
Watteträger, Laryngoskopie.....	403	Zängchen – Löffel-.....	201, 202, 204, 207, 217
Waugh Chirurgische Pinzetten.....	84	219, 221, 279, 358, 362
Weerda Sperrer.....	378	Zangenaufsätze.....	408
Weil-Blakesley Siebbeinzangen.....	282	Zaufal Fremdkörperhebel.....	237
Weitlaner (-Baby) Wundsperrer.....	101, 103, 169	Zaufal-Jansen Häkchen.....	237
Weitlaner-Wullstein Wundsperrer.....	101, 169	Hohlmeißelzangen.....	137, 180
Westmacott (West) Nasentamponzangen.....	277	Zerstäuber und Zubehör.....	275
White Tonsillenfasszangen.....	340	Ziegler Stirnspiegel.....	119
Whitehead Mundsperrer.....	331	Zirkularstanzen.....	360
Wieder Zungenspatel.....	334	Zöllner Mikroinstrumente.....	
Wiener Kieferhöhlenraspeln.....	370	Ohrspekula.....	186
Wilder Dilatatoren.....	111	Saugrohre.....	198
Williger Elevatoren.....	134	Zubehör für Elektroden.....	31
Hämmer.....	139	Zugendrücker.....	332–334
Raspatorien.....	133	Zungenspatel.....	324–329, 330–334
Scharfe Löffel.....	132, 175, 176	Zungenzangen.....	334
Wundsperrer.....	167		
Wilmer Feine Scheren.....	63		
Wisconsin-Foregger Laryngoskope.....	386		
Wullstein Mikro-Löffelzängchen.....	219		
Mikromesser.....	222		
Ohrnadeln.....	226		
Raspatorien.....	231		
Saugadapter.....	195		
Saugrohre.....	197		
Wundhaken.....	89–98, 312, 321, 350		
Wundsperrer.....	99–103, 167–169		
Würzburger Modell Septummeißel.....	301		
Xenon Stirnlampen.....	122		
Yankauer Spülkanülen.....	125		
Yasargil Fadenführer.....	310		
Gefäßhäkchen.....	310		
Tumorfasspinzetten.....	80, 82		
Young Zungenzangen.....	334		
Zangen,			
Abfall-.....	420		
Anlege-.....	77		
Biopsie- und Fass-.....	281, 354, 363, 364		
Broncho-Oesophagoskopie-.....	416		
Drahtschneide-.....	138		
Endolaryngeale Mikrochirurgie.....	396–401		
Fass-.....	78, 281, 340, 341, 354, 361, 364		
Hohlmeißel-.....	135–138, 179, 180		
Katheter-.....	128		
Kehlkopf-.....	410, 411		
Kieferhöhlenfass-.....	361		
Knochensplitter-.....	138, 181		
Korn- (Polypen)-.....	76		
Kropffass-.....	78		
Laryngo-Broncho-Oesophagoskopie-.....	414–416		
Löffel-.....	201, 202, 204, 207, 217, 219, 221, 279, 362		
Mikro Ohr-.....	203, 204, 206–208, 217, 219–221		
Mikro-Löffelzängchen.....	81, 82, 357, 358		
Nagel-.....	420		
Nasen-, -scharf.....	288, 353		
Nasentrache-, Probeexcisions-.....	357, 363		
Nasentampon-.....	277		
optische.....	4		
Polypen-.....	76, 278		
Repositions-.....	317		
Septum-.....	277–279, 281, 286, 317, 318, 354		
Siebbein-.....	280–284, 355, 356		
Tampon-.....	277, 337		
Tonsillenabszess-.....	337		
Tonsillenfass-.....	340, 341		
Tonsillenklemm-.....	73–75		

INDEX

Pages 443 – 454



INDEX

Abraham Tonsil grasping forceps.....	341
Tonsil knives.....	338
Accessories for electrodes.....	31
Accessories for spray gun.....	419
Adaptors for high-frequency equipment.....	23
Adenoid curettes.....	321–323
Adenoid cutting forceps.....	288
Adenotomes.....	323
Adson Atraumatic forceps.....	87, 256
Dressing forceps, TC.....	79, 255
Hemostatic forceps.....	73
Tissue forceps.....	83, 255
Adson Standard Dressing forceps.....	79, 255
Adson-Brown Tissue forceps.....	83
Agnew (Politzer) Paracentesis needles.....	239
Air bag.....	240
Alar retractors.....	311–314
Allis Grasping and tonsil grasping forceps.....	78, 340
Alm Self-retaining retractors.....	99
Antifog solution.....	421
Antrum and frontal sinus cannulas.....	372
Antrum chisels.....	370
curettes.....	369, 371
dissectors.....	371
grasping forceps.....	361
hooks.....	227, 321, 350
punches.....	358, 359, 365, 368
rasps.....	370
retractors.....	100, 101, 321, 350–352
Arm, flexible, for nasal specula.....	270
Artery forceps.....	68–74, 253
Asch Septum straightening forceps.....	318
Aspirating tubes.....	125, 372
Atomiser.....	275
Atrauma hemostatic forceps.....	71
Atraumatic forceps.....	86, 87, 256
Aufrecht Alar retractors.....	314
Nasal rasps.....	305, 307
Aural forceps.....	87, 166
Baby-Adson Hemostatic forceps.....	73
Baby-Crile Hemostatic forceps.....	69, 70
Baby-Crile-Wood Needle holders, TC.....	144
Baby-Lexer (Knapp) Fine scissors.....	50
Baby-McIntosh Laryngoscopes.....	385
Baby-Metzenbaum Dissecting scissors, -SUPERCUT.....	43, 244
Baby-Mixter Hemostatic forceps.....	74
Baby-Molt Mouth gags.....	330
Baby-Olsen-Hegar Needle holders, TC.....	147
Baby-Overholt Hemostatic forceps.....	74
Baby-Roux Retractors.....	94, 321, 350
Backhaus Towel forceps.....	75
Ball electrodes.....	30, 34, 35
Ballenger Gouges.....	297
Septum knives.....	290
Tonsil grasping forceps.....	340
Bandage scissors.....	66
Bane-Hartmann Bone rongeur forceps.....	135
Baracani Forceps tips.....	408
Barany Noise apparatus.....	192
Barbara Micro needles.....	226, 228
Barnes Suction tubes.....	196
Barnhill Adenoid curettes.....	322
Baron (Schuknecht) Suction tubes.....	197
Barraquer Micro needle holders.....	141
Barsky Trachea hooks.....	90
Barth Spoons.....	236
Barth-Preysing Bone curettes.....	132, 176
Battery box.....	124
Battery case for Nystagmus spectacles.....	172
Battery handles.....	
for otoscopes.....	114–117, 389
for laryngoscopes.....	384, 389
Beales Raspatories.....	231
Tendon knives.....	225
Beckmann Adenoid curettes.....	321, 322
Nasal specula.....	262
Bellucci Micro ear scissors.....	205, 207, 218
Retractors.....	102, 169
Bergmann Wound hooks.....	92
BETA 200 otoscopes.....	116
Beyer Bone rongeur forceps.....	136, 137, 179, 180
Ear punches.....	184
Billeau Loops.....	236
Binocular loupes.....	118
Biopsy forceps.....	281, 354, 363
Bipolar cables.....	28, 29
electrode system.....	32, 33
electrodes.....	32, 33
forceps, TC.....	16–19
Birkett Hemostatic forceps.....	74
Blades, scalpel.....	106, 107
Blakesley-Rudolf Ethmoid forceps.....	284, 356
Bloch Ligature guides.....	237
Blohmke Tonsil grasping forceps.....	341
Blumenthal Bone rongeur forceps.....	136
Böhler Bone cutting forceps.....	138, 181
Bone rongeur forceps.....	137, 180
Boies Septum elevators.....	316
Bone crusher.....	308
curettes.....	131, 132, 175, 176, 367
cutting forceps.....	138, 181
rongeur forceps.....	135–138, 179, 180
rongeurs, ProClean.....	184, 366
chisels.....	129, 130
Bose Trachea hooks and spreader.....	378, 379
Böttcher Tonsil scissors.....	54, 320
Boucheron Ear specula.....	187
Bowman Dilators.....	111
Nasal specula.....	272
Braun Grasping forceps.....	78
Brown Needle holders.....	142
Brünings Ear specula.....	189
Forceps tips.....	408
Septum forceps and knives.....	279, 290
Tongue depressors.....	334
Tonsil knives and snares.....	338, 342
Brünings (Mosher) Intubation tubes.....	378
Brünings-Brunk Antrum retractors.....	321, 350
Buchwald Tongue depressors.....	333
Buck Cotton applicators.....	171
Curettes.....	236
Foreign body levers.....	200
Buckingham Micro knives.....	232
Bulldog clamps.....	77, 87
Burr block for 24 burrs.....	159
Burrs.....	157–159
Cables bipolar and monopolar.....	28, 29
Cannulae.....	
Aspirating.....	125
Coagulation.....	402
Injection.....	126, 394, 403
Laryngeal.....	126
Septum.....	126, 375
Suction and wash.....	125, 152, 372, 373, 375, 402

Tonsil	126
Cannulae trachea	380–382
Caplan Septum scissors.....	286
Case for nystagmus spectacles	172
Caspar Scalpel handles for mini blades	108
Grasping forceps.....	257
Razor blade holders	109
Tissue forceps	88
Catheter forceps.....	128
Cauteries, -rechargeable	36, 37
Chadwick Fine scissors.....	64, 252
Cheek and lip retractors	103, 351
Chest supports for laryngoscopes	392
for mouth gags	329
Chevalier-Jackson Broncho-esophagoscopy forceps.....	416
Child Waste forceps.....	420
Chisels	
Antrum.....	370
Microsurgery	233
Septum.....	297, 299–301
Chisels and gouges.....	129, 130, 173, 174, 233, 297–301
Cinelli Osteotomes	302
Circular cutting punches	360
Citelli Ear punches.....	184
Citelli (-Beyer) Antrum punches.....	365
Clar Headlights	120, 121
Claus Tonsil needles	335
Claus van Eicken Suture hooks.....	336
Tonsil needles.....	336
Cleaning accessories	155, 418, 419
brushes.....	418
solution for endoscopes.....	421
tips.....	419
spray.....	155
Cleveland Bone cutting forceps	181
Bone rongeur forceps.....	135
Coakley Antrum curettes.....	371
Trocars.....	125
Cold light cable fittings.....	9
Cold light cables.....	8
Collar Button Ventilation tubes	210
Collin Tongue holding forceps	334
Columella forceps	88, 257, 314
Colver Tonsil grasping forceps	341
Cone (Adson-Baby) Self-retaining retractors.....	103
Container filters	423, 428
Container for electrodes.....	31
Containers	422–428
Converse Alar Retractors	314
Needle holders, TC.....	145
Osteotomes.....	297, 298
Rhinoplastic and nasal knives.....	288
Cordes Forceps tips	408
Cottle Alar retractors	314
Cottle Aural and nasal forceps	87
Columella forceps	88, 257, 314
Dressing forceps	79, 255
Hooks.....	311, 313
Mallets.....	139, 302
Nasal forceps	257
Nasal rasps.....	307
Nasal scissors, SUPERCUT and TC	58, 249
Nasal specula.....	269
Osteotomes.....	299, 300
Rhinoplastic and nasal knives.....	289
Septum chisels.....	300
Septum elevators	291, 293, 295

Mallets.....	182
Nasal scissors, TC.....	249
Cottle-Masing Nasal scissors.....	56, 248
Cottle-Neivert Hooks	313
Cottle-Walter Nasal specula	269
Cotton applicators.....	110–113, 171, 259, 405, 416
Cotton applicators, laryngoscopy	403
Craig (-Domnick) Polypus forceps	278
Crile (-Rankin) Hemostatic forceps.....	69, 70, 253
Crile-Wood Needle holders	142, 144
Cup-shaped forceps	201, 202, 204, 207, 217, 219, 221, 279, 358, 362
Curettes adenoid.....	321–323
Antrum.....	369, 371
Bone.....	131, 132, 175, 176, 222, 367
Ear	239
Micro	229, 232
Stapedectomy	232
Curettes.....	216, 236, 237
Cushing Wound and nerve hooks	89
Daniels Tonsillectomes	344
Davis-Boyle Mouth gags.....	327
Davis-Meyer Mouth gags.....	325
Day Ear hook.....	237
De Bakey Atraumatic forceps.....	256
Atraumatic tissue forceps	86
Bulldog clamps	77
Needle holders, TC.....	144
De Bakey-Hess Bulldog clamps	77
Denhart Mouth gags.....	330
Derlacki Tissue forceps	84, 165
Deschamps (-Standard) Ligature needles.....	148, 149
Diagnostic sets.....	114–117
Diagnostic tube	240
Dieter Malleous nippers.....	204, 218
Dilators	111, 378
Dingmann Mouth gags.....	326
Disarticulation instrument.....	216
Dissecting scissors, -TC.....	41–47, 51–53, 162, 163, 244, 245, 320
Dissecting suction tubes	152
Dissectors.....	216
Donaldson Ventilation tubes.....	210
Double-ended hooks	316
Doyen-Collin Mouth gags	330
Dressing forceps, -TC	79–82, 165, 166, 255–257, 276
Duplay Polypus and dressing forceps	76
Sponge holding forceps	337
Ear	
curettes	239
dressing forceps.....	166
forceps	200–203
hooks.....	237, 239
needles.....	226
probes	170, 239
punches, -ProClean	184, 366
specula.....	185–189
spoons.....	239
syringes	241, 242
tissue forceps	166
Eicken Periosteum raspatories.....	178
Eicken (-Killian) Cannulae.....	373
Electrode accessories	31
container	31
handles	21–24
Electrodes, bipolar	32–33
monopolar	30
Elevators.....	134, 135, 178, 216, 229, 231
Antrum.....	371

INDEX

Periosteum 295
 Septum 291–295, 316
 Tonsil 338–340
 Endoscopes for endolaryngeal microsurgery 3
 Endoscopes, accessories 2–7, 422
 Epiglottis retractors 411
Erhard Ear specula 186
 Ethmoidal forceps Rudolf ProClean 282, 355
 Ethmoidal forceps 280–282, 284, 356
Eves Tonsil snares 342
Ewald Dressing forceps 79
 Examination instruments 260
 Excavators 229, 230
 F. O. Oscopes 114, 116
Falk Tonsil needles 336
Farabeuf Periosteum raspatories 133, 177
 Retractors 95
Farell (Farell-Lathbury) Cotton applicators 113, 171
Farrior Ear specula 185
Faulkner Antrum chisels 370
 Antrum curettes 371
Fein Cotton applicators 110, 405
Ferguson Wash and suction cannulas 151, 198
Fergusson-Ackland Mouth gags 331
Ferris-Smith Septum forceps 281
Ferris-Smith-Kerrison Antrum punches 365
 Fiberoptic headlights 121, 123
 laryngoscopes 389–391
 Fiberglass light guides for laryngoscopes 394
 light cables 8
 Fine forceps 85, 256
 Fine operating scissors 47–49
 Fine scissors, –SUPER CUT, –TC 50, 61–64, 162, 164, 246, 250–252
 Finest grasping forceps 217
 Finger protectors 334
Fino Fine scissors 61, 164, 250, 251
Finsen Self-retaining retractors 99
Fisch Antrum retractors 352
 Excavators 229
 Measuring cylinders 230
 Measuring instruments 230
 Micro hooks 226
 Neurectomy knives 225
 Perforators 227
 Retractors 101, 169, 352
 Suction tubes 198
 Tenotomes 225
Fischer Tonsil knives 337
 Fistula knives 109
 Flexible forceps 7
Fomon Nasal hooks 312, 313
 Nasal rasps 304, 305, 308
 Nasal scissors, –SUPER CUT 57, 58, 248, 249
 Rhinoplastic and nasal knives 289
 Septum chisels 300
Forceps,
 Adenoid cutting 288, 353
 Antrum grasping 361
 Atraumatic 86, 87, 256
 Aural 87, 166
 Biopsy and grasping 281, 354, 363, 364
 Bipolar, –TC 16–19
 Bone cutting 138, 181
 Bone rongeur 135–138, 179, 180
 Broncho-esophagoscopy 416
 Catheter 128
 Columella 88, 257, 314

Cupped jaws 362
 Cup-shaped 201, 202, 204, 207, 217, 219, 221, 279, 358, 362
 Dressing, –TC 76, 79–82, 165, 255
 Endolaryngeal microsurgery 396–401
 Ethmoidal 280–284, 355, 356
 Fine 85, 256
 Goitre grasping 78
 Grasping 78, 281, 340, 341, 354, 361, 364
 Hemostatic 68–74, 253
 Laryngeal 410, 411
 Laryngo-broncho-esophagoscopy 414–416
 Micro 81, 82, 357, 358
 Micro ear 203, 204, 206–208, 217, 219–221
 Nail 420
 Nasal 87, 88, 257, 276
 Nasal cutting 288, 353
 Nasal dressing 277
 Nasopharynx and biopsy 357, 363
 Optical 4
 Polypus 76, 278
 Repositon 317
 Septum 277–279, 281, 286, 317, 318, 354
 Setting 77
 Sinus 76
 Sphenoidal 287, 368
 Splinter 86
 Sponge holding 277, 337
 Tissue, –TC 83, 84, 88, 165, 255
 Tongue holding 334
 Tonsil 73–75
 Tonsil abscess 337
 Tonsil grasping 340, 341
 Towel 75
 Tumor grasping 80, 82
 Waste 420
 Watchmakers' 85
 Wire cutting 138
 Tips 408
 Foreign body levers 200, 237
Formby Spoons 237
Fowler Tonsil knives 337
Fraenkel Forceps tips 408
 Laryngeal forceps 411
 Laryngeal polypus forceps 410
Frazier Hooks 309
Frazier Suction tubes 151
 Wound and nerve hooks 89
Freeman (-Gorney) Dissecting scissors, SUPER CUT 52, 53
Freeman-Kaye Dissecting scissors, SUPER CUT 52
Freer Gouges 297
 Nasal hooks 312
 Osteotomes 297
 Raspatories 294
 Rhinoplastic and nasal knives 289
Freer (-Joseph) Septum elevators 291–294
Freer-USA Mod. Septum elevators 292
Freer-Yasargil Septum elevators 292
French Hartmann Tuning forks 190
Frenzel Nystagmus spectacles 172
 Tongue depressors 333
Friedmann (-Delikat) Bone rongeur forceps 135, 179
Frohn Cotton applicators 112, 259
 Frontal sinus dilators 373
 Gags antrum 100, 351, 352
 mouth 324–332
 wound 99–103, 167–169, 378
Gallaher Nasal rasps 308

Gauze packers	335	Hartmann-Noyes Ear forceps	201
Gerald Micro forceps	82	Hartmann-Weingärtner Ear forceps	202
Tissue forceps	84	Hartmann-Wullstein Ear forceps	202
Gerzog-Sexton Knives	238	Harvey Bandage scissors	66
Gillies Tissue forceps	84	Haslinger Tonsil dissectors	340
Wound and nerve hooks	89, 309	Head bands	119
Glass basins	429	Head mirrors	119
Glass bowls	430	Headlights	120–123
Glatzel Nasal mirrors	276	Heanley Bone rongeur forceps	179
Glomus spreader	169	Heermann Finest grasping forceps	217
Goitre grasping forceps	78	Mallets	139, 182
Goldmann Septum elevators	316	Hegar-Baumgartner Needle holders, TC	143
Goldmann-Fox Gum scissors, TC	67	Hemostatic forceps	68–74, 253
Good Tonsil scissors	55, 320	Henke Elevators	339
Gorney Scissors and dissecting scissors, SUPERCUT	53, 163	Henley Self-retaining retractors	102
Gouges	129, 130, 173, 174, 297, 302	Herberhold Tongue blades	328
Graefe Fine scissors	63, 252	Heymann Nasal scissors, SUPERCUT	55, 247
Grasping forceps	257	Heymann (-Knight) Septum forceps	277
Hooks	90, 309	Höhm Mirrors	231
Tissue forceps	88	Holinger Laryngoscopes	394
Wound hooks	90	Hooks antrum	227, 321, 350
Graft holders	230	Hooks	
Grasping forceps	78–82, 257, 281, 340, 341, 354, 361, 364	Double-ended	316
Greven Micro ear forceps	204	Ear	237, 239
Gross Curettes	237	Microsurgery	226–230
Gross-Maier Polypus and dressing forceps	76	Nasal	310–315
Gruber Ear specula	187	Nerve	89
Grünwald (-Henke) Nasal cutting forceps	285	Skin	90, 92, 309
Guastella-Ey Septum chisels	301	for Stapedectomy, Stapedotomy	216
Guide needles	127	Thyroid gland	379
Guthrie Wound hooks	90	Trachea	90–93, 379
Hajek Mallets	139, 183	Wound	89–98, 309, 312, 316, 321, 350
Nasal cutting forceps	285	House Measuring rods	229
Retractors	95	Micro curettes	232
Septum forceps	354	House (-Fisch) Suction adapters, -tubes	195, 197
Hajek (Hajek-Kofler) Antrum and sphenoidal punches	287, 368	Howarth Septum elevators	292
Hajek-Balleng Septum elevators	292	HTT-cables	8
Halle Bone curettes	367	Huber Universal handles	407
Nasal scissors	58, 249	Hughes Stapes mobilizers	230
Septum elevators	291	Humby Wound and trachea hooks	91
Halsey Needle holders, TC	145	Hurd Elevators	338
Halsted-Mosquito Hemostatic forceps	71, 253	Tonsil needles	335
Handles battery, for otoscopes	114–117	Injection drain tubes	394
Handles battery for laryngoscopes	384–391	Injection needles, laryngoscopy	403
Handles cautery	36	Instrument cases	216, 424–427
for ear operating set	239	Instruments for ventilation tubes	209
for electrodes	21–24	Intubation tubes	378
for laryngeal mirrors	409	Irrigating and suction cannulae	375
for laryngoscopes	384–389	Iterson Trachea hooks	92
for sinuscope	10	Jackson Laryngoscopes	394
for stick instruments, laryngoscopy	404	Wound and trachea hooks	91, 92
scalpel	104, 105, 107, 108	Bone curettes	132, 176
scalpel, for mini blades	108	Jacobson-Adson Dressing forceps	79
Handpieces for motor system	155	Jacobson-Halsted Hemostatic forceps	72
Hartmann Antrum and frontal sinus cannulas	372	Jameson (-Werber) Fine operating scissors, -SUPERCUT	49, 246
Cotton applicators	110	Jansen Bone curettes	132, 176
Ear specula	186, 187	Bone rongeur forceps	136, 137, 179
Hemostatic forceps	72	Ear tissue forceps	166
Hooks	237	Headlights	122
Nasal cutting forceps	285	Otoscopies	240
Septum forceps	277	Periosteum raspatories	133, 177, 178
Suction tubes	195	Spoons	236
Tongue depressors	333	Jansen (Fine) Nasal forceps	88, 257, 276
Tonsil punches	345	Jansen (Gruenwald) Ear dressing forceps	166
Tuning forks	190	Nasal forceps	88, 257, 276
Hartmann (-Citelli) Ear forceps	200–202	Jansen Retractors	99, 167
Hartmann (-Halle) Nasal specula	261, 262	Jars	430

INDEX

Jennings Mouth gags..... 331
Jobson-Horne Cotton applicators 112, 171
Jones Towel forceps 75
Joseph Fine scissors 50, 246
 Nasal hooks..... 312
 Nasal rasps..... 306
 Nasal saws 303
 Periosteum elevators..... 295
 Periosteum raspatories 133
 Rhinoplastic and nasal knives 288, 289
 Scissors..... 162
 Septum elevators 291
Joseph (Cottle) Masing Elevators 295
Jurasz Adenoid cutting forceps..... 288
 Laryngeal forceps 411
Kabierske Powder blowers 240
Kazanjian Septum scissors 286
Kelly (-Rankin) Hemostatic forceps 69
Kerrison Antrum punches 368
 Ear punches 184
 Sphenoidal forceps 287
Kidney bowls..... 241, 429
Killian Cotton applicators 405
 Dilators, probes 110, 373
 Laryngectomy scissors 411
 Nasal probes 258
 Septum elevators 293
Killian (-Claus) Septum chisels 299
Killian (-Struycken) Nasal specula..... 264–268, 271, 272
Killian (-Walter) Nasal specula 268
Kilner Alar retractors 314
 Hooks 309
 Nasal scissors 56, 248
 Retractors..... 95
 Wound and nerve hooks 89
Kilner (Ragnell) Fine scissors, dissecting scissors, -TC 51, 246
Kilner-Doughty Mouth gags..... 324
Kirstein Nasal scissors 56, 247
Kleinert-Kutz Wound hooks..... 90
Kleinert-Kutz (Fomon) Nasal rasps 308
Kley Ear probes..... 170
Knapp Hooks 309
Knife electrodes..... 30
Knives
 Fistula 109
 Lancet, microsurgery..... 225
 Longitudinal, for Stapedectomy, Stapedotomy 216
 Microsurgery 222–233
 Periosteum 178
 Rhinoplastic and nasal 288, 289
 Roller, microsurgery..... 222
 Round, microsurgery 224
 Round, for Stapedectomy, Stapedotomy 216
 Septum 290
 Sickle..... 222, 369
 Surgical, for Stapedectomy, Stapedotomy 216
 Tendon, microsurgery..... 225
 Tonsil 337, 338
 Tympanum..... 239
Knot tier..... 237, 310
Kocher Hemostatic forceps..... 68
 Probes 379
Kocher (-Langenbeck) Retractors..... 97, 98
König Elevators..... 135, 178
 Ligature conductors 150
Krause Forceps tips 408
Krause (-Voss) Nasal and polypus snares 199, 273

Kressner Septum straightening forceps..... 318
Kroenig Tongue depressors 333
Kronecker Ligature needles 149
Kuhn-Bolger Antrum curettes 369
La Force Adenotomes 323
Laborde Trachea dilators..... 378
Lahey Goitre grasping forceps 78
Lancet electrodes..... 30
 Knives..... 225
Landolt Scalpel handles for mini blades 108
Lange Hooks..... 311
Langenbeck Curettes..... 236
 Elevators..... 134
 Finger protectors..... 334
 Needle holders, TC..... 146
 Retractors..... 97, 98
Langenbeck-Green Retractors..... 94
Lange-Wilde Nasal and polypus snares..... 199, 273
Laryngeal forceps..... 410, 411
 Mirrors 409
 Needles 126
 Polypus forceps 410
 Snares 403
 Stick instruments..... 404
Laryngectomy scissors 411
Laryngo-broncho-esophagoscopy forceps..... 414–416
Laryngoscope accessories..... 384, 389
Laryngoscope handles 384, 389
Laryngoscopes..... 2, 385–395
Lazar Dressing forceps..... 165
 Micro forceps 82
Lempert Bone curettes..... 131, 175
 Bone rongeur forceps..... 136, 179
Lempert Knives 238
 Raspatories 133, 231
Leriche Hemostatic forceps 70
Lewis Nasal rasps..... 307
Lexer Scissors, -SUPERCUT, -TC 42
Lichtenberg Needle holders, TC 146
Lichtwitz Sinuscopy trocars..... 374
 Trocars..... 125
Ligature conductors 150
 Forceps 70
 Guide..... 310
 Instruments 336
 Needles 148, 149
 Scissors..... 65
Lindemann Nasal saws 303
Lip and cheek retractors 103, 351
Lister Bandage scissors 66
 Sinus forceps 76, 254, 276
Littauer Ear forceps..... 200
 Ligature scissors 65
Loops 236, 237
Lopez-Reinke Elevators..... 339
Love Elevators 339
Lubet-Barbon Nasal dressing forceps 277
Lubricant for stopcocks 421
Luc Septum forceps..... 278
Lucae Aural and nasal forceps 87, 166
 Ear hook 237
 Knives..... 239
 Mallets..... 183
 Paracentesis needles 239
 Tuning forks..... 190
Lucas Chisels and gouges..... 129, 173
 Gouges..... 173

Osteotomes.....	129	Scraper.....	230
Luer Bone rongeur forceps.....	137, 180	Tenotomes.....	225
Retractors.....	93, 316	Micro-Adson Dressing forceps	79
Lukens Wound and trachea hooks.....	91	Micro-Adson (-Biemer) Tissue forceps, -TC.....	83, 255
Luniatschek Gauze packers.....	335	Micro-Mosquito Hemostatic forceps.....	72
Magill Catheter forceps.....	128	Micro-Ryder Needle holders, TC.....	145
Magnet racks.....	428	Microsurgery.....	222–233
Maintenance products.....	421	Microsurgery hooks.....	222, 226–230
Malleous nippers.....	204	Middeldorpf Retractors.....	98, 321, 350
Mallets.....	138, 139, 182, 183, 302	Middleton-Jansen Septum forceps.....	286
Maltz Nasal rasps, - TC.....	304–306	Mikulicz Tonsil forceps.....	74, 75
Rhinoplastic and nasal knives.....	289	Miller Bone curettes.....	176
Manicure sets.....	420	Fiberoptic Laryngoscopes.....	391
Marschik Tissue forceps.....	84	Laryngoscopes.....	388
Martini Bone curettes.....	132, 176	Miller Nasal rasps, -TC.....	305, 306
Masing Alar retractors.....	314	Millesi Micro scissors.....	60, 163
Chisels.....	302	Mini-Lambotte Osteotomes.....	130, 298
Elevators.....	295	Mini-Lexer Gouges, Osteotomes.....	130, 174
Rhinoplastic and nasal knives.....	289	Mirror handles.....	409
Masing (Silver) Septum chisels.....	301	Mirrors.....	
Mathieu Needle holders, TC.....	146	Head.....	119
Mayo Scissors, -TC.....	43	Laryngeal.....	409
Tongue depressors.....	333	Micro.....	231
Mayo-Hegar Needle holders.....	142, 143	Nasal.....	276
Mc Donald Elevators.....	135, 294	Mod. Rudolf Antrum punches.....	359
Mc Gee Micro hooks.....	227	Bandage scissors.....	66
Wire bending forceps.....	204, 218	Cotton applicators.....	113
Mc Gee/Fisch Wire closure forceps.....	208	Operating and dissecting scissors, -SUPER CUT.....	40, 41, 51
Mc Indoe Chisels.....	203	Mod. USA Tissue forceps.....	83
Dissecting scissors.....	53	Mod. Wien Nasal specula.....	263
Dressing forceps.....	80	Modell Würzburg Tongue blades.....	328
Tissue forceps.....	84	Mollison Self-retaining retractors.....	102
Mc Intosh Laryngoscopes.....	385	Molt Periosteum raspatories.....	133
Fiber-Optic Laryngoscopes.....	389, 390	Monopolar cables and safety cables.....	27
Mc Ivor Mouth gags.....	328	Monopolar electrodes.....	30
Mc Kenty Septum elevators.....	291, 292	Moritz-Schmidt Tongue depressors.....	332
Mead Bone rongeur forceps.....	136	Mosquito Atrauma hemostatic forceps.....	71
Mallets.....	183	Mosquito-Dandy Hemostatic forceps.....	73
Measuring cylinders.....	230	Mouth gags.....	324–328, 330–332
Instruments.....	216, 229, 230	Murphy Head bands.....	119
Rods.....	229, 230	Museux Tonsil grasping forceps.....	340
Medicine cups.....	430	Musgrove Hooks.....	237
Metal stand for ear specula.....	187	Myles Nasal cutting forceps.....	285
Metzenbaum (-Fino) Dissecting scissors, -SUPER CUT, -TC.....	44–47, 162, 244, 245, 320	Septum forceps.....	354
Meyerding Wound hooks.....	92	Nager Elevators.....	339
Michel Laryngeal mirrors.....	409	Tonsil needles.....	335
Micro- Compass saws for motor system.....	156	Nailbrushes.....	421
Cup-shaped forceps.....	204, 207, 217, 219, 221	Nail files.....	420
Curettes.....	232	Forceps.....	420
Ear forceps.....	203, 204, 206–208, 217, 219–221	Scissors.....	67
Ear scissors.....	205, 207, 208, 217, 218, 221	Nasal.....	
Forceps.....	81, 82, 357, 358	Cutting forceps.....	285, 288, 345, 353
Hooks.....	216, 226–228	Dressing forceps.....	277
Knives.....	222–233	Forceps.....	87, 88, 257, 276
Lancet Knives.....	225	Hooks.....	310–315
Motor.....	154	Knives.....	288, 289
Needle holders.....	141	Mirrors.....	276
Needles.....	226–229	Probes.....	258
Neurectomy knives.....	225	Punches.....	361
Nippers.....	218, 359	Rasps, -TC.....	304–308
Oscillating saws, for motor system.....	156	Saws.....	303
Punches.....	218, 359	Scissors, -TC, -SUPER CUT.....	55–58, 247–249, 363
Roller Knives.....	222	Snares and snare wire.....	273
Round Knives.....	224, 225	Specula.....	261–272
Scissors.....	59, 60, 163, 217, 218, 221, 358	Nasopharyngoscopes.....	6
		Nasopharynx and biopsy forceps.....	357, 363
		Needle cases.....	429

INDEX

Electrodes, -bipolar.....	30,34
Holders, -TC.....	141–147
Needles	
For Stapedectomy, Stapedotomy.....	216
Guide.....	127
Injection.....	403
Ligature.....	148, 149
Microsurgery.....	226–229
Needles	
Paracentesis.....	222, 239
Surgical.....	140
Tonsil.....	335, 336
Negus Adenoid currettes.....	321
Laryngoscopes.....	387
Tonsil forceps.....	74
Wire guides.....	336
Neivert Needle holders, -TC.....	143
Septum chisels.....	301
Neivert (Masing) Hooks.....	313
Nerve dissecting scissors.....	53
Hooks.....	89
Neurectomy knives.....	225
Neutral electrodes, rubber; accessories.....	26
Noise apparatus.....	194
Northbent Ligature scissors.....	65
Nystagmus spectacles.....	172
Ochsner-Kocher Hemostatic forceps.....	68
O'Connor Wound hooks.....	90
Ollier Retractors.....	97
Olsen-Hegar Needle holders, -TC.....	147
Operating scissors, -fine.....	40–43, 47–49
Operation laryngoscopes.....	392–395
Ophthalmoscopes BETA 200.....	116
Optical forceps.....	4
Osteotomes.....	129, 130, 173, 174, 297–302
Otoscopes	
Endoscopy.....	2
BETA 100, BETA 200.....	114–116
Palate blades.....	325
Paparella Ventilation tubes.....	211
Parkes Hump gouges.....	302
Nasal rasps.....	304
Partsch Chisels and gouges.....	129, 173
Passow Pestles.....	130, 174
Péan Hemostatic forceps.....	68
Pelteson Cotton applicators.....	110, 405
Pennington Elevators.....	294
Perforators.....	227
For Stapedectomy, Stapedotomy.....	216
Periosteum elevators.....	295
raspatories.....	133, 134
Perkins Antrum retractors.....	100, 351
Perwitschky Tonsil knives.....	337
Pestles.....	130, 174
Pharyngoscopes.....	5
Piccolo Cotton applicators.....	171
Pierce Elevators.....	294
Trocars.....	125
Plaster spatulas.....	110
Plastic containers for endoscopes.....	422
Plastic surgery	
Fine scissors, SUPERCUT.....	47
Plate electrodes.....	30
Plester Antrum hooks.....	227
Antrum retractors.....	352
Hooks, micro hooks.....	226, 227, 230
Micro knives.....	223
Scrapers.....	230
Suction tubes.....	151, 198
Wire guides.....	230
Plester (-Helms) Retractors.....	100, 168
Pliers, wire cutting and bending.....	138
Politzer Air bag.....	240
Ear specula.....	185
Knives.....	238
Myringotomes.....	239
Tympaanum perforators.....	239
Polypus and dressing forceps.....	76, 278
Polypus snares.....	199, 273
Potts-Smith Dressing forceps, -TC.....	82
Powder blowers and accessories.....	240
Power burrs and cutters, Sources for headlights.....	124
Supplies for otoscopes.....	116
Pravaz Cannulae.....	126
Preparation trays.....	231, 308
Pressure Forceps.....	233
Prince Tonsil scissors.....	54
Probes.....	110, 379
Ear.....	170
Frontal sinus.....	373
Measuring.....	229, 230
Nasal.....	258
Salival.....	111
ProClean Bone rongeurs.....	366
Protective shield for micro instruments.....	208
shields for optics.....	422
visor for binocular loupe.....	118
Providence Hemostatic forceps.....	70, 253
Punches	
Antrum.....	358–361, 368
Circular cutting.....	360
Ear, -ProClean.....	184, 366
Malleous.....	204, 218
Micro.....	359
Nasal.....	361
Sinus.....	364
Sphenoidal.....	287, 368
Quervain Elevators.....	134, 178
Quinby Gum scissors.....	67
Quire Foreign body levers.....	200
Rack for ear forceps.....	208
Ragnell-Davis Retractors.....	94, 316
Raspatories.....	133, 134, 152, 177, 178, 229, 231, 294, 404
Rasps.....	304–308, 370
Razor blades and -holders.....	109
Receptacles.....	430
Rechargeable battery handles.....	114–117
Cautery set.....	37
Redon guide needles.....	127
Regensburg Mirrors.....	231
Reichert Epiglottis retractors.....	411
Reposition forceps.....	317
Retractors	
Alar.....	312, 314
Antrum.....	100, 321, 350–352
Cheek and lip.....	103, 351
Double-ended.....	313, 316
Epiglottis.....	411
Nasal.....	311–315
Thyroid gland.....	379
Trachea.....	378
Wound.....	90–103, 167–169, 309, 312, 316, 321, 350
Reuter-Bobbin Ventilation tubes.....	210
Reynolds Dissecting scissors, SUPERCUT.....	52

Fine operating scissors, -SUPER CUT.....	49
Rhinoplastic knives	288, 289
Ritter-Halle Frontal sinus dilators.....	373
Rochester-Péan Hemostatic forceps	68
Roeder Ligature instruments	336
Rogge Waste forceps	420
Roller knives, microsurgery	222
Rollet Skin hook.....	309
Ronis Nasopharyngeal biopsy forceps.....	357
Rose Retractors	93
Rosen Elevators.....	229
Lancet knives	225
Rosen Micro curettes.....	229
Micro knives	224, 225
Micro needles.....	226, 228, 229
Raspatories	229
Rosen (House) Suction tubes	197
Roser-König Mouth gags.....	330
Rotation racks	428
Round cutting knives.....	224, 225
Roux Retractors.....	94
Rowe Reposition forceps.....	317
Rubber airways.....	379
Band elastic, for neutral electrodes	26
Neutral electrodes	26
Rubin Osteotomes	301
Septum straightening forceps	318
Rudolf Oil spray	421
Rudolf Care Instrument Oil	421
Rudolf (Swedish Pattern)	
Needle holders, TC.....	145
Rulers	113, 260
Ruskin Bone rongeur forceps.....	138
Rydel-Seiffer Tuning forks.....	191
Ryder Needle holders, TC.....	145
Safety cables, monopolar.....	27
Sage Tonsil snares	343
Salival probes	111
Scissors.....	53, 320
Sarot Needle holders, TC	146
Saws.....	156, 303
Saws and blades for motor system.....	156
Scalpel blades and mini blades.....	106, 107
Handles	104, 105, 107, 108
Schädel Towel forceps.....	75
Scheinmann Forceps tips	408
Schmeden Nasal cutting forceps	285
Schmidt Tonsil forceps	73, 341
hemostatic forceps.....	73, 341
Schoenborn Thyroid gland retractors	379
Schuknecht Micro knives	222
Bandage Scissors	66
Scissors.....	164
Suction tubes	197
Wire bending die	233
Wire bending forceps	204
Schumacher Forceps tips	408
Scissors	
Bandage	66
Crurotomy	208
Dissecting, -TC.....	42-47, 51-53, 162, 163, 244, 245, 320
Fine, -TC.....	40-50, 61-64, 162, 164, 246, 250-252
Ligature	65
Micro	59, 60, 163, 207, 217, 218, 221, 358
Micro ear	205-208
Nail	67
Nasal	55-58, 247-249, 363

Operating, -TC	40-43, 47-49
Scissors	
Plastic surgery.....	47
Salival	53, 320
Septum	286
Strabismus	63, 252
SUPER CUT	42-53, 55-58, 62-64, 163
TC.....	40-67, 162, 164, 244-252, 320
Tenotomy.....	251
Tonsil	54, 55, 320
Wire cutting	65, 164
Scrapers, micro	230
Sebileau Elevators.....	135, 178
Seemann-Seiffert (Standard) Mouth gags.....	332
Seiffert Ear probes.....	170
Forceps tips.....	408
Seiffert Salival probes.....	111
Semken Dressing forceps, -TC	80, 165
Tissue forceps	84, 165
Senning Needle holders	142
Senn-Miller Retractors	93, 316
Septum	
Chisels.....	297, 299-302
Elevators.....	291-293, 316
Forceps, -straightening forceps	277-279, 281, 286, 317, 318, 354
Gouges.....	297
Knives.....	290
Needles	126, 375
Osteotomes.....	297
Scissors.....	286
Setting forceps for bulldog clamps	77
Sewall Antrum dissectors	371
Elevators.....	135
Sexton Knives.....	238
Shambaugh Adenotomes.....	323
Micro hooks.....	226
Shapleigh Curettes.....	236
Shea Micro curettes.....	232
Micro ear scissors	205
Sheehan (Rubin) Osteotomes.....	298
Shepard Grommet Ventilation tubes.....	210
Sickle knives.....	239, 369
Siebenmann Dilators	111
Tamper.....	258
Siegle Ear specula	188
Silicone sheeting for medical purposes	211
Simon Fistula knives	109
Sinus forceps.....	76, 254, 276, 364
Punches	364
Sinoscope handles and tubes	10
Sinoscopes.....	4
Sinuscopy trocars	374
Skin hooks.....	90, 92, 309
Sliding gauge for stapedectomy and tympanoplasty.....	209
Sluder-Ballenger Tonsillectomes	344
Snare loops and wire for tonsil snares	343
for polypus snares.....	199
Snellen Curettes	236
Spare parts and accessories, for cautery	37
Spare parts and accessories for head mirrors, headlights.....	119-123
Specula, ear	185-189
Spencer Ligature scissors	65
Sphenoidal forceps	287, 368
Spirit lamps	429
Splinter forceps	86
Sponge holding forceps	277, 337
Spoons	236, 237, 239

INDEX

Spratt Bone curettes 131
 Spray guns, accessories 418, 419
 Spreader, glomus 169
St. Clair-Thompson Adenoid curettes 322
Stacke (-Frenzel) Probes, ear probes 110, 170
Standard Dressing forceps, -TC 79
 Fine scissors 62
 Scissors, -TC 40, 41
 Tissue forceps 83
 Wound and trachea hooks 91
Standard-Grazil Scissors 42
 Stapedectomy curettes 232
 Stapes mobiliser 230
 Sterilisation accessories for endoscopes 422
Sternberg Cheek and lip retractors 351
 Tongue depressors 332
Stevens Fine scissors, -SUPER CUT 63
 Tenotomy scissors 251
 Strabismus scissors, -TC 63, 64
Strümpel (-Voss) Ear forceps 202
Strümpel (-Voss) Nasal cutting forceps 353
 Septum forceps 279
Struycken Nasal cutting forceps 285
 Septum forceps 354
 Suction adapters 195
 Raspatories 152, 404
 Tubes and irrigating cannulae 125, 151, 152, 195–198, 375, 394
 Tubes, laryngoscopy 402
 SUPERCUT scissors 42–53, 55, 57, 58, 62–64, 163
 Surgical motor system 154
 Needles 140
 Pusher 237, 310
 Syringes, ear 241, 242
 Syringes 127
Tabb Microsurgery knives 222
Takahashi Ethmoid forceps 280
 Ethmoid forceps Rudolf ProClean 280
 Nasal cutting forceps 353
 Nasal cutting forceps Rudolf ProClean 353
 Tamper 258
 Tendon knives 225
 Tenotomes 225
 Tenotomy scissors 251
 Textile filters for container 423–428
Thies Chisels and gouges 173
Thilenius Tonsil abscess forceps 337
Thudichum Nasal specula 272
 Thyroid gland retractors 379
Tieck Nasal specula 262
Tilley Ear forceps 200
 Nasal dressing forceps 277
 Tips for cauteries 36, 37
 Tissue forceps, -TC 83–85, 88, 165, 166, 255–257
 Picks 310
Tobold Tongue depressors 333
 Tongue blades 324–329, 333, 334
 Depressors 332–334
 Holding forceps 334
Tönnis (-Adson) Tonsil scissors, -TC 54
 Tonsil
 Abscess forceps 337
 Compressors 345
 Tonsil
 Dissectors 340
 Forceps 73–75
 Grasping forceps 340, 341
 Hemostatic forceps 73–75, 341

Knives 337, 338
 Needles 126, 335, 336
 Punches 345
 Scissors, -TC 54, 55, 320
 Snares 342, 343
 Tonsillectomes 344
 Towel forceps 75
Toynbee Ear specula 186
 Trachea dilators 378
 Hooks 90–93, 379
 Retractors 378
 Trocars 379
 Transformers 36, 124
 Trocars 125
 Sinuscopy 374
 Trachea 379
Troeltsch (Wilde) Aural and nasal forceps 87, 166, 276
Trousseau (-Baby) Trachea dilators 378
 Tube instrumentation 209
 Tubes for universal handles 407
Tuebinger ventilation tubes 211, 80, 82
 Tuning forks and tuning fork sets 191–193
 Tyding Tonsil snares 342
 Tympanum knives 239
 Perforators 239
Uckermann Trachea trocars 379
Uffendorfer Bone curettes 132, 367
Ulrich Polypus and dressing forceps 76
Universal Bandage scissors 66
 Cotton applicators 112, 171, 259
 Handles 407
 Wire cutting scissors, -TC 65, 164
 Vein dissector 216
 Ventilation and T-tube inserter 209
 Ventilation tubes, long-term application
 Paparella 211
 T-Tube 211
 Tuebinger 211
 Ventilation tubes, middle-term application
 Collar Button
Reuter Bobbin 210
 Ventilation tubes, short-term application
 Donaldson 210
 Shepard Grommet 210
Vogel Antrum puncture trocars 374
Volkman Bone curettes 131, 175
 Retractors 96
 Trachea hooks 93
Wagener Ear hook 237
Wagner Fine scissors 48, 246
 Wall plug transformers for headlights 124
Walsham Septum straightening forceps 317
Walter Osteotomes 300
 Septum chisels 300
Walter Septum elevators 316
 Waste forceps 420
 Watchmaker's forceps 85
Watson-Williams Ethmoid forceps 280, 281
 Septum forceps 354
Waugh Tissue forceps 84
Wieder Tongue depressors 334
Weerda Retractors 378
Weil-Blakesley Ethmoid forceps 282
Weitlaner (-Baby) Retractors 101, 103, 169
Weitlaner-Wullstein Retractors 101, 169
Westmacott (West) Nasal dressing forceps 277
White Tonsil grasping forceps 340

Whitehead Mouth gags	331
Wiener Antrum rasps	370
Wilder Dilators	111
Williger Bone curettes	132, 175, 176
Elevators.....	134
Mallets.....	139
Periosteum raspatories	133
Williger Retractors	167
Wilmer Fine scissors.....	63
Wire baskets for endoscopes	422, 423
Bending die	233
Bending forceps	204, 208, 218
Cutting and bending pliers.....	138, 204, 208, 218
Cutting scissors, – TC	164, 65
Guides	230, 336
Loops	199
Wisconsin-Foregger Laryngoscopes	386
Wound hooks	89–98, 309, 312, 316, 321, 350
Wullstein Ear needles	226
Micro cup-shaped forceps.....	219
Micro knives	222
Raspatories	231
Suction adapters.....	195
Suction tubes	197
Würzburger Modell Septum chisels	301
Xenon headlights.....	122
Yankauer Aspirating tubes	125
Yasargil Ligature guide	310
Tumor grasping forceps	80, 82
Young Tongue holding forceps	334
Zaufal Foreign body levers	237
Zaufal-Jansen Bone rongeur forceps	137, 180
Hooks	237
Ziegler Head mirrors.....	119
Zöllner Ear specula.....	186
Suction tubes	198

INDEX

NUMMERNVERZEICHNIS

NUMERICAL INDEX

Seiten / Pages 455 – 472

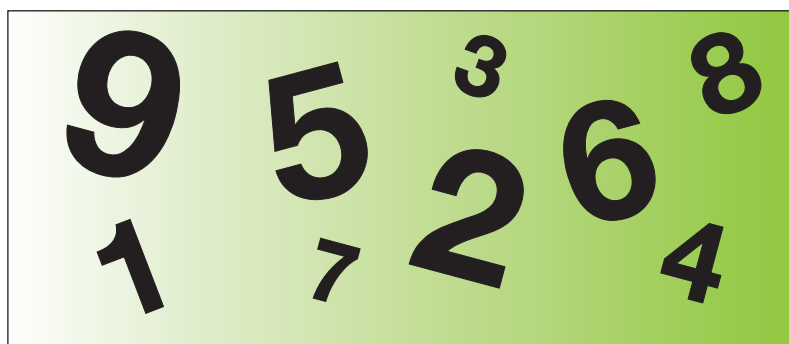

NUMMERNVERZEICHNIS
NUMERICAL INDEX

EN100-070.....	2	RU 0165-03.....	10	RU 0466-47/03.....	28	RU 1003-15.....	40
EN100-090.....	2	RU 0165-04.....	10	RU 0466-47/05.....	28	RU 1003-16.....	40
EN100-170.....	2	RU 0165-50.....	10	RU 0466-48/03.....	28	RU 1004-14.....	40
EN100-190.....	2	RU 0165-51.....	10	RU 0466-48/05.....	28	RU 1006-14.....	40
EN100-270.....	2	RU 0165-52.....	10	RU 0466-60/04.....	29	RU 1008-14.....	40
EN100-290.....	2	RU 0165-56.....	10	RU 0466-62/04.....	29	RU 1010-14.....	41
EN100-370.....	2	RU 0165-57.....	10	RU 0466-64/04.....	29	RU 1011-11.....	41
EN127-000.....	2	RU 0400-21.....	4	RU 0466-66/03.....	29	RU 1011-13.....	41
EN127-030.....	2	RU 0465-01/01.....	21	RU 0466-66/05.....	29	RU 1011-14.....	41
EN127-100.....	4	RU 0465-01/02.....	21	RU 0466-68/04.....	29	RU 1011-15.....	41
EN127-130.....	4	RU 0465-01/03.....	21	RU 0467-02.....	23	RU 1011-16.....	41
EN127-170.....	4	RU 0465-01/04.....	21	RU 0470-01.....	30	RU 1012-11.....	41
EN127-200.....	4	RU 0465-01/13.....	22	RU 0470-02.....	30	RU 1012-13.....	41
EN127-230.....	4	RU 0465-01/15.....	22	RU 0470-04.....	30	RU 1012-14.....	41
EN127-270.....	4	RU 0465-01/33.....	22	RU 0470-10.....	30	RU 1012-15.....	41
EN129-000.....	3	RU 0465-01/35.....	22	RU 0470-11.....	30	RU 1012-16.....	41
EN129-030.....	3	RU 0465-02/03.....	23	RU 0470-15.....	30	RU 1013-11.....	41
EN140-000.....	4	RU 0465-02/05.....	23	RU 0470-17.....	30	RU 1013-13.....	41
EN140-030.....	4	RU 0465-02/13.....	23	RU 0470-19.....	30	RU 1013-14.....	41
EN140-045.....	4	RU 0465-02/15.....	23	RU 0470-24.....	30	RU 1013-15.....	41
EN140-070.....	4	RU 0465-03/03.....	23	RU 0470-26.....	30	RU 1013-16.....	41
EN140-100.....	2	RU 0465-03/05.....	23	RU 0470-28.....	30	RU 1014-14.....	41
EN140-130.....	2	RU 0465-03/13.....	23	RU 0470-31.....	30	RU 1016-14.....	41
EN140-200.....	5	RU 0465-03/15.....	23	RU 0470-33.....	30	RU 1018-14.....	41
EN140-230.....	5	RU 0465-04/03.....	24	RU 0470-35.....	30	RU 1021-13.....	42
EN140-270.....	5	RU 0465-05/05.....	24	RU 0470-37.....	30	RU 1021-14.....	42
EN150-130.....	3	RU 0465-05/13.....	24	RU 0470-41.....	30	RU 1022-13.....	42
EN150-170.....	3	RU 0465-06/03.....	24	RU 0470-42.....	30	RU 1022-14.....	42
EN155-000.....	3	RU 0465-06/05.....	24	RU 0470-43.....	30	RU 1023-13.....	42
EN155-030.....	3	RU 0465-06/13.....	24	RU 0470-51.....	30	RU 1023-14.....	42
EN200-010.....	6	RU 0465-06/15.....	24	RU 0470-52.....	30	RU 1031-13.....	42
EN200-011.....	6	RU 0465-07/13.....	24	RU 0470-54.....	30	RU 1031-14.....	42
IM201-180.....	8	RU 0465-08/03.....	23	RU 0470-60.....	30	RU 1032-13.....	42
IM201-180.....	8	RU 0465-08/05.....	23	RU 0470-65.....	30	RU 1032-14.....	42
IM201-230.....	8	RU 0466-01/03.....	21	RU 0470-67.....	30	RU 1033-13.....	42
IM201-300.....	8	RU 0466-01/05.....	21	RU 0470-69.....	30	RU 1033-14.....	42
IM201-350.....	8	RU 0466-02/03.....	21	RU 0470-74.....	30	RU 1101-16.....	42
IM202-180.....	8	RU 0466-02/05.....	21	RU 0470-83.....	30	RU 1101-16 MC.....	42
IM202-230.....	8	RU 0466-03/03.....	21	RU 0470-85.....	30	RU 1103-16.....	42
IM202-300.....	8	RU 0466-03/05.....	21	RU 0471-88.....	31	RU 1250-14.....	43
IM202-350.....	8	RU 0466-15/03.....	25	RU 0471-89.....	31	RU 1251-14.....	43
IM210-230.....	8	RU 0466-17/03.....	25	RU 0471-90.....	31	RU 1252-14.....	43
IM212-180.....	8	RU 0466-17/05.....	25	RU 0471-95.....	31	RU 1253-14.....	43
IM212-230.....	8	RU 0466-18/05.....	25	RU 0490-35 A.....	27	RU 1280-11.....	43,244
IM220-020.....	9	RU 0466-19/03.....	25	RU 0490-35 B.....	27	RU 1280-11 MC.....	43
IM220-021.....	9	RU 0466-19/05.....	25	RU 0490-85.....	27	RU 1281-11.....	43,244
IM220-022.....	9	RU 0466-20/03.....	25	RU 0490-86.....	27	RU 1281-11 MC.....	43
IM220-023.....	9	RU 0466-20/05.....	25	RU 0490-87.....	27	RU 1290-14.....	44
IM220-024.....	9	RU 0466-30/01.....	26	RU 0752-00.....	6	RU 1290-14 MC.....	44
IM220-025.....	9	RU 0466-30/02.....	26	RU 1000-14.....	40	RU 1291-14.....	44,244
IM220-040.....	9	RU 0466-32/01.....	26	RU 1001-11.....	40	RU 1291-14 MC.....	44
IM220-041.....	9	RU 0466-32/02.....	26	RU 1001-13.....	40	RU 1301-14.....	44,244
IM220-042.....	9	RU 0466-34/50.....	26	RU 1001-14.....	40	RU 1304-14.....	44,162,244
IM220-044.....	9	RU 0466-34/55.....	26	RU 1001-15.....	40	RU 1306-14.....	44,162
IM220-045.....	9	RU 0466-36/01.....	26	RU 1001-16.....	40	RU 1311-14.....	45,245
IM220-046.....	9	RU 0466-43/03.....	28	RU 1002-11.....	40	RU 1311-14 MC.....	45
IM220-047.....	9	RU 0466-43/05.....	28	RU 1002-13.....	40	RU 1314-14.....	45,162,245
IM220-048.....	9	RU 0466-44/03.....	28	RU 1002-14.....	40	RU 1316-14.....	45,162
IM220-049.....	9	RU 0466-44/05.....	28	RU 1002-15.....	40	RU 1321-18.....	46
RF0110-12.....	7	RU 0466-45/03.....	28	RU 1002-16.....	40	RU 1321-20.....	46
RF 1010-12.....	7	RU 0466-45/05.....	28	RU 1003-11.....	40	RU 1326-18.....	46
RU 0165-01.....	10	RU 0466-46/03.....	28	RU 1003-13.....	40	RU 1330-18.....	46
RU 0165-02.....	10	RU 0466-46/05.....	28	RU 1003-14.....	40	RU 1330-18 MC.....	46

**NUMMERNVERZEICHNIS
NUMERICAL INDEX**

RU 1330-20.....	46	RU 1730-19.....	53	RU 2441-11.....	63,251	RU 3031-13.....	68
RU 1331-18.....	46,245,320	RU 1792-15.....	53,163	RU 2441-11 MC.....	63	RU 3031-14.....	68
RU 1331-18 MC.....	46	RU 1810-18.....	54,320	RU 2455-10.....	63,252	RU 3050-14.....	69
RU 1331-20.....	46,320	RU 1811-18.....	54	RU 2457-10.....	63	RU 3050-16.....	69
RU 1331-20 MC.....	46	RU 1815-17.....	54	RU 2460-11.....	63,252	RU 3051-14.....	69
RU 1334-18.....	47,245	RU 1820-18.....	54	RU 2461-11.....	63,252	RU 3051-16.....	69
RU 1334-20.....	47	RU 1821-18.....	54	RU 2462-11.....	64,164,252	RU 3068-14.....	69,253
RU 1336-18.....	47,320	RU 1825-17.....	54	RU 2462-11 MC.....	64	RU 3069-14.....	69,253
RU 1336-20.....	47,320	RU 1829-17.....	54	RU 2463-11.....	64,164,252	RU 3070-14.....	69,253
RU 1503-12.....	47	RU 1845-19.....	55,320	RU 2463-11MC.....	64	RU 3070-16.....	69
RU 1503-12 MC.....	47	RU 2115-18.....	55,247	RU 2470-11.....	64,252	RU 3071-14.....	69,253
RU 1513-12.....	47	RU 2115-18 MC.....	55,247	RU 2476-02.....	64,252	RU 3071-16.....	69
RU 1513-12 MC.....	47	RU 2116-19.....	55,247	RU 2476-03.....	64,252	RU 3072-14.....	69
RU 1518-11 MC.....	48	RU 2117-18.....	56,247	RU 2500-14.....	65	RU 3073-14.....	69
RU 1519-11 MC.....	48	RU 2120-10.....	56,248	RU 2510-09.....	65	RU 3074-14.....	70
RU 1521-12.....	48,246	RU 2121-10.....	56,248	RU 2510-10.....	65	RU 3074-16.....	70
RU 1522-12.....	48,246	RU 2124-11.....	56,248	RU 2510-12.....	65	RU 3075-14.....	70
RU 1523-12.....	48,246	RU 2130-13.....	57,248	RU 2520-12.....	65	RU 3075-16.....	70
RU 1524-12.....	48,246	RU 2130-13 MC.....	57,248	RU 2600-12.....	65	RU 3076-14.....	70
RU 1525-12.....	48,246	RU 2131-13.....	57,248	RU 2601-12.....	65	RU 3077-14.....	70
RU 1526-12.....	48,246	RU 2131-13 MC.....	57,248	RU 2602-14.....	66	RU 3080-15.....	70
RU 1580-15.....	49	RU 2132-13.....	58,249	RU 2602-16.....	66	RU 3081-15.....	70
RU 1580-15 MC.....	49	RU 2132-13 MC.....	58,249	RU 2602-18.....	66	RU 3082-15.....	70
RU 1580-18.....	49	RU 2135-16.....	58,249	RU 2610-12.....	66	RU 3083-15.....	70
RU 1581-15.....	49	RU 2135-16 MC.....	58,249	RU 2615-10.....	66,164	RU 3090-14.....	70,253
RU 1581-18.....	49	RU 2136-16.....	58,249	RU 2650-09.....	66	RU 3091-14.....	70,253
RU 1582-15 MC.....	49	RU 2140-19.....	58,249	RU 2650-11.....	66	RU 3097-09.....	71
RU 1583-15 MC.....	49	RU 2370-12.....	59	RU 2650-14.....	66	RU 3100-12.....	71,253
RU 1583-18 MC.....	49	RU 2370-16.....	59	RU 2650-15.....	66	RU 3100-14.....	71
RU 1584-13.....	49,246	RU 2371-12.....	59	RU 2650-18.....	66	RU 3100-18.....	71
RU 1584-15.....	49,246	RU 2371-16.....	59	RU 2903-13.....	67	RU 3100-21.....	71
RU 1630-09.....	62	RU 2372-16.....	60	RU 2911-12.....	67	RU 3101-12.....	71,253
RU 1630-09 MC.....	50	RU 2373-16.....	60	RU 2942-11.....	67	RU 3101-14.....	71
RU 1630-10.....	62	RU 2376-16.....	60,163	RU 2980-09.....	67	RU 3101-18.....	71
RU 1630-11.....	62	RU 2377-16.....	60,163	RU 2980-10.....	67	RU 3101-21.....	71
RU 1630-11 MC.....	50	RU 2406-11.....	62,250	RU 2981-09.....	67	RU 3110-12.....	71,253
RU 1631-09.....	62	RU 2406-11 MC.....	62	RU 2981-10.....	67	RU 3110-14.....	71
RU 1631-09 MC.....	50	RU 2407-11.....	62,250	RU 3000-13.....	68	RU 3110-18.....	71
RU 1631-10.....	62	RU 2407-11 MC.....	62	RU 3000-14.....	68	RU 3110-21.....	71
RU 1631-11.....	62	RU 2418-10.....	61,250	RU 3000-16.....	68	RU 3111-12.....	71,253
RU 1631-11 MC.....	50	RU 2418-11.....	61,250	RU 3000-18.....	68	RU 3111-14.....	71
RU 1636-09.....	50,246	RU 2419-10.....	61,250	RU 3000-20.....	68	RU 3111-18.....	71
RU 1650-10.....	50	RU 2419-11.....	61,250	RU 3001-13.....	68	RU 3111-21.....	71
RU 1651-10.....	50	RU 2420-09.....	61,251	RU 3001-14.....	68	RU 3114-13.....	72
RU 1670-14.....	50,162,246	RU 2420-10.....	61,251	RU 3001-16.....	68	RU 3115-13.....	72
RU 1671-14.....	50,162,246	RU 2420-11.....	61,251	RU 3001-18.....	68	RU 3120-10.....	72
RU 1675-12.....	51,246	RU 2421-09.....	61,251	RU 3001-20.....	68	RU 3120-12.....	72
RU 1675-13.....	51,246	RU 2421-10.....	61,251	RU 3010-13.....	68	RU 3121-10.....	72
RU 1675-15.....	51,246	RU 2421-11.....	61,251	RU 3010-14.....	68	RU 3121-12.....	72
RU 1676-11 MC.....	51	RU 2422-09.....	61,164,251	RU 3010-16.....	68	RU 3122-10.....	72
RU 1676-12.....	51	RU 2422-10.....	61,164,251	RU 3010-18.....	68	RU 3122-12.....	72
RU 1676-14 MC.....	51	RU 2422-11.....	61,164,251	RU 3010-20.....	68	RU 3123-10.....	72
RU 1677-13 MC.....	52	RU 2423-09.....	61,164,251	RU 3011-13.....	68	RU 3123-12.....	72
RU 1680-18 MC.....	52	RU 2423-10.....	61,164,251	RU 3011-14.....	68	RU 3137-12.....	72
RU 1681-18 MC.....	52	RU 2423-11.....	61,164,251	RU 3011-16.....	68	RU 3140-10.....	72
RU 1682-19 MC.....	52	RU 2430-10.....	63,251	RU 3011-18.....	68	RU 3141-10.....	72
RU 1683-19 MC.....	52	RU 2430-11.....	63,251	RU 3011-20.....	68	RU 3142-10.....	72
RU 1688-12 MC.....	53,163	RU 2431-10.....	63,251	RU 3020-13.....	68	RU 3143-10.....	72
RU 1688-19 MC.....	53	RU 2431-11.....	63,251	RU 3020-14.....	68	RU 3179-12.....	73
RU 1689-12 MC.....	53,163	RU 2440-10.....	63,251	RU 3021-13.....	68	RU 3181-12.....	73
RU 1689-19 MC.....	53	RU 2440-11.....	63,251	RU 3021-14.....	68	RU 3200-18.....	73
RU 1693-18 MC.....	53	RU 2440-11 MC.....	63	RU 3030-13.....	68	RU 3201-18.....	73
RU 1706-10.....	53,320	RU 2441-10.....	63,251	RU 3030-14.....	68	RU 3205-14.....	73

NUMMERNVERZEICHNIS
NUMERICAL INDEX

RU 3205-18 73	RU 4034-15 79	RU 4130-00/15 83,255	RU 4301-03 18
RU 3210-19 74	RU 4035-12 79,255	RU 4130-12 83,255	RU 4302-46 19
RU 3211-19 74	RU 4035-15 79,255	RU 4130-15 83,255	RU 4302-49 19
RU 3289-14 74	RU 4036-12 79,255	RU 4131-12 83	RU 4302-52 19
RU 3328-14 74	RU 4036-15 79,255	RU 4135-12 83,255	RU 4302-76 19
RU 3328-18 74	RU 4038-15 80	RU 4135-15 255	RU 4302-82 19
RU 3387-01 74	RU 4040-12 80,165	RU 4136-12 83	RU 4305-01/19 32
RU 3387-02 74	RU 4040-15 80,165	RU 4137-12 83	RU 4305-01/22 32
RU 3499-18 74	RU 4042-15 80	RU 4137-15 83	RU 4305-01/35 32
RU 3501-20 74	RU 4064-22/01 80	RU 4138-15 84	RU 4305-02/01 33
RU 3504-18 75	RU 4064-22/02 80	RU 4138-15/01 84	RU 4305-02/02 33
RU 3505-20 75	RU 4064-22/04 80	RU 4140-12 84,165	RU 4305-02/03 33
RU 3506-20 75	RU 4064-22/05 80	RU 4140-15 84,165	RU 4426-01 89
RU 3550-09 75	RU 4064-22/06 80	RU 4142-12 84	RU 4426-02 89
RU 3552-05 75	RU 4064-22/07 80	RU 4142-15 84	RU 4430-03/01 90,309
RU 3552-09 75	RU 4064-24/01 80	RU 4143-12 84,165	RU 4430-03/02 90,309
RU 3600-09 75	RU 4064-24/02 80	RU 4146-22 84	RU 4430-03/03 90
RU 3600-11 75	RU 4064-24/03 80	RU 4155-15 84	RU 4430-03/04 90
RU 3600-13 75	RU 4068-12 81	RU 4155-18 84	RU 4430-03/10 90
RU 3600-15 75	RU 4068-15 81	RU 4155-20 84	RU 4430-03/11 90
RU 3617-11 75	RU 4069-12 81	RU 4155-25 84	RU 4430-03/12 90
RU 3617-13 75	RU 4069-15 81	RU 4155-30 84	RU 4430-03/13 90
RU 3800-22 76	RU 4070-17 82	RU 4170-18 84	RU 4430-03/20 90
RU 3801-22 76	RU 4071-17 82	RU 4171-18 84	RU 4434-13 90
RU 3810-12 76,254	RU 4075-05 82,165	RU 4240-03 85	RU 4435-03 90
RU 3810-16 76,254,276	RU 4075-08 82,165	RU 4240-04 85	RU 4435-05 90
RU 3810-18 76,254	RU 4078-03 82	RU 4240-05 85,165	RU 4435-07 90
RU 3815-17 76	RU 4078-04 82	RU 4240-06 85	RU 4436-01 90
RU 3860-20 76	RU 4090-18 82	RU 4240-07 85	RU 4436-02 90
RU 3860-25 76	RU 4090-21 82	RU 4240-08 85	RU 4437-00 91
RU 3861-20 76	RU 4090-25 82	RU 4250-10 85,256	RU 4438-17 91
RU 3861-25 76	RU 4092-15 82	RU 4251-10 85,256	RU 4439-17 91
RU 3881-20 76	RU 4092-18 82	RU 4260-10 85,256	RU 4460-01 91
RU 3936-20 77	RU 4092-20 82	RU 4261-10 85,256	RU 4460-02 91
RU 3936-30 77	RU 4092-23 82	RU 4270-01 86	RU 4460-03 91
RU 4000-10 79	RU 4092-25 82	RU 4270-02 86	RU 4460-04 91
RU 4000-11 79	RU 4100-10 83	RU 4270-03 86	RU 4461-01 91
RU 4000-13 79	RU 4100-11 83	RU 4270-04 86	RU 4461-02 91
RU 4000-14 79	RU 4100-13 83	RU 4270-05 86	RU 4461-03 91
RU 4000-15 79	RU 4100-14 83	RU 4270-11 86	RU 4461-04 91
RU 4000-16 79	RU 4100-15 83	RU 4270-12 86	RU 4462-01 91
RU 4000-18 79	RU 4100-16 83	RU 4270-13 86	RU 4462-02 91
RU 4000-20 79	RU 4100-18 83	RU 4270-14 86	RU 4462-03 91
RU 4000-25 79	RU 4100-20 83	RU 4270-15 86	RU 4462-04 91
RU 4002-14 79	RU 4100-25 83	RU 4300-27 16	RU 4463-01 91
RU 4002-16 79	RU 4102-13 83	RU 4300-28 16	RU 4463-02 91
RU 4002-18 79	RU 4102-14 83	RU 4300-30 16	RU 4463-03 91
RU 4002-20 79	RU 4102-16 83	RU 4300-50 17	RU 4463-04 91
RU 4002-25 79	RU 4102-18 83	RU 4300-51 17	RU 4464-01 92
RU 4010-11 79	RU 4102-20 83	RU 4300-55 17	RU 4464-02 92
RU 4010-13 79	RU 4102-25 83	RU 4300-56 17	RU 4464-03 92
RU 4010-14 79	RU 4103-16 83	RU 4300-57 17	RU 4464-04 92
RU 4010-16 79	RU 4103-20 83	RU 4300-60 17	RU 4465-01 92
RU 4010-18 79	RU 4110-11 83	RU 4300-61 17	RU 4465-02 92
RU 4010-20 79	RU 4110-13 83	RU 4300-65 17	RU 4465-03 92
RU 4010-25 79	RU 4110-14 83	RU 4300-66 17	RU 4465-04 92
RU 4024-13 79	RU 4110-16 83	RU 4300-67 17	RU 4468-13 92
RU 4024-15 79	RU 4110-18 83	RU 4300-70 18	RU 4469-14 92
RU 4026-15 79,255	RU 4110-20 83	RU 4300-71 18	RU 4470-01 92
RU 4032-12 79	RU 4110-25 83	RU 4300-75 18	RU 4470-02 92
RU 4033-12 79	RU 4111-14 83	RU 4300-76 18	RU 4470-03 92
RU 4033-15 79	RU 4123-14 83	RU 4301-01 18	RU 4470-04 92
RU 4034-12 79	RU 4130-00/12 83,255	RU 4301-02 18	RU 4470-05 92

NUMMERNVERZEICHNIS
NUMERICAL INDEX

RU 4471-01.....	92	RU 4530-01.....	98	RU 4714-15.....	102	RU 4900-11.....	110
RU 4471-02.....	92	RU 4530-02.....	98	RU 4718-00.....	102	RU 4900-13.....	110
RU 4472-02.....	93	RU 4530-03.....	98	RU 4718-01.....	102	RU 4900-14.....	110
RU 4472-03.....	93	RU 4530-04.....	98	RU 4718-19.....	102	RU 4901-11.....	110
RU 4472-04.....	93	RU 4530-05.....	98	RU 4718-25.....	102	RU 4901-13.....	110
RU 4472-06.....	93	RU 4530-06.....	98	RU 4718-32.....	102	RU 4901-14.....	110
RU 4472-24.....	167	RU 4530-07.....	98	RU 4719-13.....	103	RU 4910-11.....	110
RU 4472-25.....	167	RU 4531-01.....	98	RU 4722-13.....	103	RU 4910-13.....	110
RU 4472-26.....	167	RU 4531-05.....	98	RU 4723-13.....	103	RU 4910-14.....	110
RU 4473-02.....	93	RU 4531-06.....	98	RU 4736-17.....	169	RU 4914-13.....	110
RU 4473-03.....	93	RU 4536-01.....	98	RU 4784-00.....	169	RU 4914-14.....	110
RU 4473-04.....	93	RU 4536-02.....	98	RU 4850-03.....	104	RU 4916-10.....	110
RU 4473-06.....	93	RU 4538-11.....	98	RU 4850-04.....	104	RU 4916-10.....	170
RU 4477-13.....	93	RU 4538-12.....	98	RU 4850-07.....	104	RU 4916-10/01.....	170
RU 4479-11.....	93,316	RU 4538-13.....	98	RU 4850-08.....	104	RU 4919-01.....	110,258
RU 4486-01.....	93,316	RU 4538-14.....	98	RU 4850-09.....	104	RU 4919-26.....	170
RU 4486-02.....	93,316	RU 4538-15.....	98	RU 4850-31.....	105	RU 4919-26/01.....	170
RU 4488-14.....	94,316	RU 4538-16.....	98	RU 4850-41.....	105	RU 4920-13.....	110
RU 4490-01.....	94	RU 4538-17.....	98	RU 4850-78.....	105	RU 4921-01.....	110
RU 4490-02.....	94	RU 4538-18.....	98	RU 4850-79.....	105	RU 4921-23.....	110,405
RU 4490-03.....	94	RU 4538-19.....	98	RU 4851-10.....	106	RU 4922-28.....	110,405
RU 4490-13.....	94	RU 4538-20.....	98	RU 4851-11.....	106	RU 4922-50.....	110,405
RU 4490-16.....	94	RU 4551-01.....	98,321,350	RU 4851-12.....	106	RU 4924-18.....	111,170
RU 4490-25.....	94	RU 4551-02.....	98,321,350	RU 4851-13.....	106	RU 4927-01.....	111,258
RU 4492-00.....	94	RU 4551-03.....	98,321,350	RU 4851-15.....	106	RU 4927-02.....	111,258
RU 4492-01.....	94	RU 4640-05.....	99	RU 4851-18.....	106	RU 4927-12.....	171
RU 4492-02.....	94	RU 4640-07.....	99	RU 4851-19.....	106	RU 4928-01/11.....	171
RU 4492-03.....	94	RU 4641-05.....	99	RU 4851-20.....	106	RU 4928-02/11.....	171
RU 4492-13.....	94,321,350	RU 4641-07.....	99	RU 4851-21.....	106	RU 4928-18.....	111,258
RU 4492-19.....	95	RU 4642-07.....	99	RU 4851-22.....	106	RU 4930-12.....	112,171,259
RU 4492-20.....	95	RU 4645-09.....	99,167	RU 4851-23.....	106	RU 4930-16.....	112,171,259
RU 4492-21.....	95	RU 4650-07.....	99	RU 4851-24.....	106	RU 4931-18.....	112,171,259
RU 4497-12.....	95	RU 4650-10.....	99	RU 4851-25.....	106	RU 4932-12.....	112,171,259
RU 4497-15.....	95	RU 4651-07.....	99	RU 4852-10.....	106	RU 4932-16.....	112,171,259
RU 4500-01.....	96	RU 4651-10.....	99	RU 4852-11.....	106	RU 4932-18.....	112,171,259
RU 4500-02.....	96	RU 4655-01/10.....	99	RU 4852-12.....	106	RU 4933-02/18.....	112,171
RU 4500-03.....	96	RU 4655-10.....	99	RU 4852-13.....	106	RU 4934-01.....	112,259
RU 4500-04.....	96	RU 4680-10.....	99,167	RU 4852-15.....	106	RU 4934-02.....	112,259
RU 4500-06.....	96	RU 4681-10.....	99,167	RU 4852-18.....	106	RU 4934-03.....	112,259
RU 4500-08.....	96	RU 4688-01.....	100,351	RU 4852-19.....	106	RU 4934-11.....	112,259
RU 4501-01.....	96	RU 4688-02.....	100,351	RU 4852-20.....	106	RU 4934-12.....	112,259
RU 4501-02.....	96	RU 4689-01.....	168	RU 4852-21.....	106	RU 4934-13.....	112,259
RU 4501-03.....	96	RU 4689-02.....	168	RU 4852-22.....	106	RU 4935-14.....	113,171
RU 4501-04.....	96	RU 4690-01.....	100,168,352	RU 4852-23.....	106	RU 4935-16.....	113,171
RU 4501-06.....	96	RU 4690-02.....	100,168,352	RU 4852-24.....	106	RU 4936-14.....	113,171
RU 4501-08.....	96	RU 4691-01.....	100,168,352	RU 4852-25.....	106	RU 4936-16.....	113,171
RU 4502-02.....	96	RU 4691-02.....	100,168,352	RU 4853-01.....	107	RU 4937-12.....	113
RU 4502-03.....	96	RU 4694-05.....	101,352	RU 4853-02.....	107	RU 4937-14.....	113
RU 4502-04.....	96	RU 4694-06.....	101,352	RU 4853-33.....	107	RU 4937-16.....	113
RU 4502-06.....	96	RU 4694-07.....	101,352	RU 4853-34.....	107	RU 4937-18.....	113
RU 4502-08.....	96	RU 4694-08.....	101,352	RU 4853-35.....	107	RU 4938-12.....	113
RU 4506-11.....	97	RU 4694-11.....	101,352	RU 4853-64.....	107	RU 4938-14.....	113
RU 4507-11.....	97	RU 4700-10.....	101	RU 4853-65.....	107	RU 4938-16.....	113
RU 4510-03.....	97	RU 4700-13.....	101,169	RU 4853-67.....	107	RU 4938-18.....	113
RU 4510-04.....	97	RU 4700-16.....	101,169	RU 4853-69.....	107	RU 4939-12.....	113
RU 4511-21.....	97	RU 4701-10.....	101	RU 4854-03.....	108	RU 4939-14.....	113
RU 4522-01.....	97	RU 4701-13.....	101,169	RU 4854-04.....	108	RU 4939-16.....	113
RU 4522-02.....	97	RU 4701-16.....	101,169	RU 4854-10.....	108	RU 4939-18.....	113
RU 4522-05.....	97	RU 4710-13.....	101,169	RU 4854-11.....	108	RU 4940-38.....	416
RU 4523-01.....	97	RU 4710-16.....	101,169	RU 4870-01.....	109	RU 5104-10.....	113,260
RU 4523-02.....	97	RU 4711-13.....	101,169	RU 4870-02.....	109	RU 5104-15.....	113,260
RU 4523-03.....	97	RU 4711-16.....	101,169	RU 4874-00.....	109	RU 5104-20.....	113,260
RU 4523-04.....	97	RU 4713-13.....	102,169	RU 4878-13.....	109	RU 5114-10.....	113,260

NUMMERNVERZEICHNIS
NUMERICAL INDEX

RU 5123-50.....	116	RU 5140-42.....	172	RU 5178-03.....	394	RU 5255-19.....	125,374
RU 5123-60.....	116	RU 5140-50.....	172	RU 5178-11.....	394	RU 5258-30.....	125
RU 5123-63.....	116	RU 5140-70.....	172	RU 5178-12.....	394	RU 5258-40.....	125
RU 5123-70.....	116	RU 5145-34.....	118	RU 5180-00.....	385	RU 5258-50.....	125
RU 5126-10.....	114	RU 5145-45.....	118	RU 5180-01.....	385	RU 5260-01.....	125
RU 5126-11.....	114	RU 5145-70.....	118	RU 5180-02.....	385	RU 5260-27.....	125
RU 5126-20.....	114	RU 5145-71.....	118	RU 5180-03.....	385	RU 5285-02.....	127
RU 5126-21.....	114	RU 5145-72.....	118	RU 5180-04.....	385	RU 5285-02/Z.....	127
RU 5126-22.....	114	RU 5150-09.....	119	RU 5180-05.....	385	RU 5285-05.....	127
RU 5126-36.....	114	RU 5150-10.....	119	RU 5180-08.....	384	RU 5285-05/Z.....	127
RU 5126-37.....	114	RU 5150-20.....	119	RU 5180-09.....	384	RU 5285-10.....	127
RU 5126-38.....	114	RU 5150-25.....	119	RU 5180-10....	384-386, 388	RU 5285-10/Z.....	127
RU 5126-39.....	114	RU 5151-09.....	119	RU 5180-10/01.....	384	RU 5291-28.....	127
RU 5126-40.....	114	RU 5151-10.....	119	RU 5180-11.....	384	RU 5291-30.....	127
RU 5126-45.....	114	RU 5151-20.....	119	RU 5180-12.....	384	RU 5291-32.....	127
RU 5126-46.....	114	RU 5152-09.....	119	RU 5180-13.....	384	RU 5291-34.....	127
RU 5126-50.....	114	RU 5153-00.....	120	RU 5180-14.....	384	RU 5291-48.....	127
RU 5126-51.....	114	RU 5154-00.....	120	RU 5180-30.....	385	RU 5291-50.....	127
RU 5127-10.....	115	RU 5154-80.....	120	RU 5180-40.....	385	RU 5291-52.....	127
RU 5127-11.....	115	RU 5154-85.....	120	RU 5180-42.....	385	RU 5291-54.....	127
RU 5127-20.....	115	RU 5154-90.....	120	RU 5180-99....	385-387, 390	RU 5295-20.....	128
RU 5127-21.....	115	RU 5155-00.....	120	RU 5182-00.....	386	RU 5295-25.....	128
RU 5127-22.....	115	RU 5155-05.....	120	RU 5182-01.....	386	RU 5300-04.....	129,173
RU 5127-34.....	115	RU 5155-10.....	121	RU 5182-02.....	386	RU 5300-06.....	129,173
RU 5127-35.....	115	RU 5155-15.....	121	RU 5182-03.....	386	RU 5300-08.....	129,173
RU 5127-36.....	115	RU 5155-20.....	121	RU 5182-04.....	386	RU 5300-10.....	129,173
RU 5127-37.....	115	RU 5155-99.....	120-122	RU 5182-31.....	386	RU 5300-12.....	129,173
RU 5127-38.....	115	RU 5157-10.....	122	RU 5182-99.....	386	RU 5300-14.....	129
RU 5127-39.....	115	RU 5157-20.....	122	RU 5184-01.....	387	RU 5300-16.....	129
RU 5127-40.....	115	RU 5157-21.....	122	RU 5184-02.....	387	RU 5302-04.....	129,173
RU 5127-45.....	115	RU 5158-20.....	123	RU 5184-03.....	387	RU 5302-06.....	129,173
RU 5127-46.....	115	RU 5158-21.....	123	RU 5184-04.....	387	RU 5302-08.....	129,173
RU 5127-50.....	115,117	RU 5158-40.....	123	RU 5184-20.....	387	RU 5302-10.....	129,173
RU 5127-51.....	115	RU 5158-41.....	123	RU 5185-00.....	388	RU 5302-12.....	129,173
RU 5128-20.....	116	RU 5161-01.....	124	RU 5185-01.....	388	RU 5302-14.....	129
RU 5128-21.....	116	RU 5161-02.....	124	RU 5185-02.....	388	RU 5302-16.....	129
RU 5128-22.....	116	RU 5161-03.....	124	RU 5185-03.....	388	RU 5304-04.....	129,173
RU 5128-40.....	116	RU 5161-04.....	124	RU 5185-04.....	388	RU 5304-06.....	129,173
RU 5128-41.....	116	RU 5161-05.....	124	RU 5185-10.....	384,387	RU 5304-08.....	129,173
RU 5128-42.....	116	RU 5161-20.....	124	RU 5185-30.....	388	RU 5304-10.....	129,173
RU 5130-02.....	117	RU 5170-01.....	392	RU 5185-40.....	388	RU 5304-12.....	129,173
RU 5130-03.....	117	RU 5170-02.....	392	RU 5185-99.....	388,391	RU 5304-14.....	129
RU 5130-04.....	117	RU 5170-11.....	392	RU 5188-00.....	389	RU 5304-16.....	129
RU 5130-12.....	117	RU 5170-12.....	392	RU 5188-01.....	389,390	RU 5305-01/03.....	173
RU 5130-13.....	117	RU 5170-13.....	393	RU 5188-02.....	389,390	RU 5305-01/04.....	129,173
RU 5130-14.....	117	RU 5170-14.....	393	RU 5188-03.....	389,390	RU 5305-01/05.....	173
RU 5130-22.....	117	RU 5170-15.....	393	RU 5188-04.....	389,390	RU 5305-01/06.....	129,173
RU 5130-23.....	117	RU 5170-16.....	393	RU 5188-08.....	389	RU 5305-02/03.....	173
RU 5130-24.....	117	RU 5170-17.....	393	RU 5188-10.....	389-391	RU 5305-02/04.....	129,173
RU 5130-32.....	117	RU 5170-23.....	394	RU 5188-10/01.....	389	RU 5305-02/05.....	173
RU 5130-33.....	117	RU 5170-24.....	394	RU 5188-12.....	389	RU 5305-02/06.....	129,173
RU 5130-34.....	117	RU 5170-25.....	394	RU 5188-30.....	390	RU 5308-02.....	129,173
RU 5130-40.....	117	RU 5170-31.....	394	RU 5188-40.....	390	RU 5308-03.....	129,173
RU 5130-52.....	117	RU 5170-33.....	394	RU 5189-00.....	391	RU 5308-04.....	129
RU 5130-53.....	117	RU 5171-11.....	395	RU 5189-01.....	391	RU 5308-05.....	129,173
RU 5130-54.....	117	RU 5171-12.....	395	RU 5189-02.....	391	RU 5308-06.....	129
RU 5130-70.....	117	RU 5171-13.....	395	RU 5189-03.....	391	RU 5308-07.....	129,173
RU 5140-00.....	172	RU 5171-14.....	395	RU 5189-04.....	391	RU 5308-08.....	129,173
RU 5140-11.....	172	RU 5171-15.....	395	RU 5189-30.....	391	RU 5309-03.....	173
RU 5140-22.....	172	RU 5171-16.....	395	RU 5189-40.....	391	RU 5309-04.....	173
RU 5140-23.....	172	RU 5171-17.....	395	RU 5189-50.....	391	RU 5314-02.....	129,173
RU 5140-40.....	172	RU 5178-01.....	394	RU 5252-15.....	125	RU 5314-03.....	129,173
RU 5140-41.....	172	RU 5178-02.....	394	RU 5253-16.....	125	RU 5314-04.....	129

**NUMMERNVERZEICHNIS
NUMERICAL INDEX**

RU 5314-05	129,173	RU 5362-03.....	367	RU 5588-15/1	137,180	RU 5899-02 S	140
RU 5314-06	129	RU 5366-00.....	132,176	RU 5589-15	137,180	RU 5899-03.....	140
RU 5314-07	129,173	RU 5366-01.....	132,176	RU 5589-15/1	137,180	RU 5899-03 S	140
RU 5314-08	129,173	RU 5366-12.....	132,176	RU 5590-18	137,180	RU 5899-04.....	140
RU 5315-03	173	RU 5367-00/16.....	132,176	RU 5592-18	137,180	RU 5899-04 S	140
RU 5315-04	173	RU 5368-00.....	132,176	RU 5594-18	138	RU 5899-05.....	140
RU 5317-03	130,174	RU 5368-01.....	132,176	RU 5648-15	181	RU 5899-05 S	140
RU 5317-05	130,174	RU 5368-12.....	132,176	RU 5648-17	181	RU 5901-01 S	140
RU 5317-07	174	RU 5369-00/19.....	132,176	RU 5700-15	138,181	RU 5901-02 S.....	140
RU 5317-09	174	RU 5369-13	132,176	RU 5701-15.....	138,181	RU 5901-03 S.....	140
RU 5318-02	130,174	RU 5370-18	176	RU 5759-16	138	RU 5901-04 S.....	140
RU 5318-03	130,174	RU 5374-01	306	RU 5798-24	138,182	RU 5901-05 S.....	140
RU 5332-02.....	130,298	RU 5374-02.....	306	RU 5798-51	138,182	RU 5900-10	140
RU 5332-03	130,298	RU 5374-03	306	RU 5799-18	138,182,302	RU 5900-10 S.....	140
RU 5332-04	130,298	RU 5379-19	133	RU 5799-51	138,182,302	RU 5901-01	140
RU 5332-06.....	130,298	RU 5380-15.....	133,177	RU 5807-19.....	139,182	RU 5901-02.....	140
RU 5332-08.....	130,298	RU 5381-15.....	133,177	RU 5809-19	139,182,302	RU 5901-03.....	140
RU 5332-10	130,298	RU 5388-16	133,177	RU 5810-23	139	RU 5901-04.....	140
RU 5332-12	130,298	RU 5392-05.....	133	RU 5811-23.....	139,183	RU 5901-05.....	140
RU 5332-15	130,298	RU 5392-08.....	133	RU 5812-19.....	139,183	RU 5928-13	142
RU 5332-22	298	RU 5392-16	133	RU 5813-01	183	RU 5928-18	142
RU 5332-24	298	RU 5394-06.....	133,177,294	RU 5813-02	183	RU 5973-12	141
RU 5332-26	298	RU 5394-08.....	133,177,294	RU 5814-16.....	139	RU 6003-16.....	142
RU 5332-28	298	RU 5399-00/16	133	RU 5815-16.....	139	RU 6003-18.....	142
RU 5332-30.....	298	RU 5410-01	134,177	RU 5816-17.....	183	RU 6003-20.....	142
RU 5332-32.....	298	RU 5410-02	134,177	RU 5816-20	183	RU 6012-15.....	142
RU 5334-04.....	130,174	RU 5410-03.....	134,177	RU 5860-12	141	RU 6017-17	142
RU 5334-06.....	130,174	RU 5410-04.....	134,177	RU 5860-15	141	RU 6045-13	143
RU 5334-08.....	130,174	RU 5413-06	178	RU 5865-12	141	RU 6050-16	143
RU 5334-10	130,174	RU 5414-09	178	RU 5865-15	141	RU 6050-18	143
RU 5334-12	130,174	RU 5414-14	178	RU 5875-10	140	RU 6050-20.....	143
RU 5335-04.....	130,174	RU 5420-20.....	134	RU 5875-10 S	140	RU 6052-14	143
RU 5335-06.....	130,174	RU 5426-16	134	RU 5875-11.....	140	RU 6053-20.....	143
RU 5335-08.....	130,174	RU 5427-20	134,178	RU 5875-11 S	140	RU 6054-18	144
RU 5335-10	130,174	RU 5431-01	135,178	RU 5875-12	140	RU 6054-20.....	144
RU 5335-12	130,174	RU 5431-02.....	135	RU 5875-12 S	140	RU 6054-23.....	144
RU 5350-01.....	131,175	RU 5434-19	135,294	RU 5875-13	140	RU 6054-40.....	144
RU 5350-02.....	131,175	RU 5436-17	135,178	RU 5875-13 S	140	RU 6054-41	144
RU 5350-03.....	131,175	RU 5559-17	135	RU 5875-14	140	RU 6055-01.....	144
RU 5350-04.....	131,175	RU 5560-14.....	135,179	RU 5875-14 S	140	RU 6055-15/1	144
RU 5350-05.....	131,175	RU 5561-15.....	179	RU 5875-15	140	RU 6055-18	144
RU 5350-06.....	131,175	RU 5561-90.....	179	RU 5875-15 S	140	RU 6055-20.....	144
RU 5350-10	131,175	RU 5562-14	135	RU 5875-16	140	RU 6056-13/1	145
RU 5350-20.....	131,175	RU 5566-16	136	RU 5875-16 S	140	RU 6056-13/2.....	145
RU 5350-30.....	131,175	RU 5568-16	136	RU 5879-10	140	RU 6057-12.....	145
RU 5350-40.....	131,175	RU 5570-16	136,179	RU 5879-10 S	140	RU 6059-13	145
RU 5353-01.....	131	RU 5570-19	136,179	RU 5879-11	140	RU 6059-16	145
RU 5353-02.....	131	RU 5571-16.....	136,179	RU 5879-11 S	140	RU 6059-18	145
RU 5353-03.....	131	RU 5571-19.....	136,179	RU 5879-12	140	RU 6059-20.....	145
RU 5353-04.....	131	RU 5572-18.....	136,179	RU 5879-12 S	140	RU 6059-63.....	145
RU 5353-05.....	131	RU 5573-17	136	RU 5879-13	140	RU 6059-65.....	145
RU 5353-06.....	131	RU 5574-17.....	136	RU 5879-13 S	140	RU 6059-68.....	145
RU 5353-10	131	RU 5575-01	136	RU 5879-14	140	RU 6059-70	145
RU 5353-20	131	RU 5575-02.....	136	RU 5879-14 S	140	RU 6060-00/15	145
RU 5353-30.....	131	RU 5575-03.....	136	RU 5879-15	140	RU 6060-00/17.....	145
RU 5356-01.....	175	RU 5576-19	137,179	RU 5879-15 S	140	RU 6060-18	146
RU 5356-02.....	175	RU 5578-19	179	RU 5879-16	140	RU 6066-17	146
RU 5356-10	175	RU 5580-17	137,180	RU 5879-16 S	140	RU 6066-20.....	146
RU 5356-20.....	175	RU 5581-17.....	137,180	RU 5898-10	140	RU 6067-50	146
RU 5357-01	132,367	RU 5582-15	137	RU 5898-10 S.....	140	RU 6067-54	146
RU 5357-02	132,367	RU 5583-15	137	RU 5899-01	140	RU 6068-20.....	146
RU 5362-01	367	RU 5584-15	137	RU 5899-01 S	140	RU 6079-11	147
RU 5362-02.....	367	RU 5588-15	137,180	RU 5899-02.....	140	RU 6080-14	147

NUMMERNVERZEICHNIS
NUMERICAL INDEX

RU 6080-17	147	RU 6420-60.....	151	RU 7587-08	77,87	RU 7791-340	157
RU 6104-20	148	RU 6420-62.....	151	RU 7680-12	71	RU 7791-345	157
RU 6106-20	148	RU 6420-65.....	151	RU 7681-12.....	71	RU 7791-350	157
RU 6108-03.....	148	RU 6420-76.....	151	RU 7790-045.....	155	RU 7791-360	157
RU 6108-04.....	148	RU 6420-78.....	151	RU 7790-050.....	156	RU 7791-370	157
RU 6110-21.....	149	RU 6420-80.....	151	RU 7790-051.....	156	RU 7791-406.....	158
RU 6112-21.....	149	RU 6420-82.....	151	RU 7790-052.....	156	RU 7791-407.....	158
RU 6118-15.....	149	RU 6420-85.....	151	RU 7790-053.....	156	RU 7791-408.....	158
RU 6119-15.....	149	RU 6421-06.....	151,198	RU 7790-054.....	156	RU 7791-410	158
RU 6141-19.....	150	RU 6421-07.....	151,198	RU 7790-055.....	156	RU 7791-414.....	158
RU 6142-19.....	150	RU 6421-08.....	151,198	RU 7790-060.....	156	RU 7791-418	158
RU 6143-20	150	RU 6421-09.....	151,198	RU 7790-061.....	156	RU 7791-427	158
RU 6249-05.....	378	RU 6421-10.....	151,198	RU 7790-062.....	156	RU 7791-431	158
RU 6249-07.....	378	RU 6421-11.....	151,198	RU 7790-063.....	156	RU 7791-435.....	158
RU 6249-09.....	378	RU 6421-12.....	151,198	RU 7790-064.....	156	RU 7791-440	158
RU 6250-13.....	378	RU 6421-15.....	151,198	RU 7790-065.....	156	RU 7791-445.....	158
RU 6250-15.....	378	RU 6422-15.....	151,198	RU 7790-066.....	156	RU 7791-450.....	158
RU 6251-14.....	378	RU 6422-20.....	151,198	RU 7790-067.....	156	RU 7791-460.....	158
RU 6252-13.....	378	RU 6422-25.....	151,198	RU 7790-068.....	156	RU 7791-470	158
RU 6253-07.....	378	RU 6422-30.....	151,198	RU 7791-006.....	157	RU 7791-499.....	158
RU 6254-19.....	378	RU 6429-30.....	152	RU 7791-007.....	157	RU 7792-010	158
RU 6255-01.....	379	RU 6456-01.....	365	RU 7791-008.....	157	RU 7792-014	158
RU 6255-02.....	379	RU 6456-02.....	365	RU 7791-010.....	157	RU 7792-018	158
RU 6257-21.....	379	RU 6456-03.....	365	RU 7791-014.....	157	RU 7792-023.....	158
RU 6259-08.....	379	RU 6456-04.....	365	RU 7791-018.....	157	RU 7792-027.....	158
RU 6259-10.....	379	RU 6456-05.....	365	RU 7791-023.....	157	RU 7792-031.....	158
RU 6272-01.....	382	RU 6456-52 P.....	366	RU 7791-027.....	157	RU 7792-035.....	158
RU 6272-02.....	382	RU 6456-53 P.....	366	RU 7791-035.....	157	RU 7792-040.....	158
RU 6272-03.....	382	RU 6456-54 P.....	366	RU 7791-040.....	157	RU 7792-045.....	158
RU 6272-04.....	382	RU 6456-55 P.....	366	RU 7791-045.....	157	RU 7792-050.....	158
RU 6272-05.....	382	RU 6457-01.....	365	RU 7791-050.....	157	RU 7792-060.....	158
RU 6272-06.....	382	RU 6457-02.....	365	RU 7791-060.....	157	RU 7792-070.....	158
RU 6272-10.....	382	RU 6457-03.....	365	RU 7791-070.....	157	RU 7792-107.....	158
RU 6272-20.....	382	RU 6457-04.....	365	RU 7791-106.....	157	RU 7792-110.....	158
RU 6272-30.....	382	RU 6457-05.....	365	RU 7791-108.....	157	RU 7792-115.....	158
RU 6277-15.....	379	RU 6457-52 P.....	366	RU 7791-110.....	157	RU 7792-118.....	158
RU 6277-16.....	379	RU 6457-53 P.....	366	RU 7791-114.....	157	RU 7792-125.....	158
RU 6280-15.....	78	RU 6457-54 P.....	366	RU 7791-118.....	157	RU 7792-130	158
RU 6296-01.....	89,309	RU 6457-55 P.....	366	RU 7791-123.....	157	RU 7792-135	158
RU 6296-02.....	89,309	RU 6458-01.....	365	RU 7791-127.....	157	RU 7792-140	158
RU 6297-15.....	89,309	RU 6458-02.....	365	RU 7791-131.....	157	RU 7792-145	158
RU 6357-10.....	270	RU 6458-03.....	365	RU 7791-135.....	157	RU 7792-150	158
RU 6357-50.....	270	RU 6458-04.....	365	RU 7791-140.....	157	RU 7792-160.....	158
RU 6357-53.....	270	RU 6458-05.....	365	RU 7791-145.....	157	RU 7792-170.....	158
RU 6357-54.....	270	RU 6500-15.....	78,340	RU 7791-150.....	157	RU 7792-206.....	158
RU 6357-55.....	270	RU 6502-15.....	340	RU 7791-160.....	157	RU 7792-207	158
RU 6357-58.....	270	RU 6524-24.....	420	RU 7791-170.....	157	RU 7792-208.....	158
RU 6392-13.....	89,309	RU 7175-20.....	78	RU 7791-235.....	157	RU 7792-210	158
RU 6392-18.....	89,309	RU 7197-16.....	78	RU 7791-240.....	157	RU 7792-215	158
RU 6393-13.....	89,309	RU 7580-16.....	86,256	RU 7791-245.....	157	RU 7792-218	158
RU 6393-18.....	89,309	RU 7580-20.....	86	RU 7791-250.....	157	RU 7792-223.....	158
RU 6417-01.....	151	RU 7581-16.....	86	RU 7791-260.....	157	RU 7792-227	158
RU 6420-05.....	151	RU 7581-20.....	86	RU 7791-270.....	157	RU 7792-230	158
RU 6420-06.....	151	RU 7582-16.....	86	RU 7791-306.....	157	RU 7792-235.....	158
RU 6420-07.....	151	RU 7582-20.....	86	RU 7791-307.....	157	RU 7792-240.....	158
RU 6420-08.....	151	RU 7584-16.....	86	RU 7791-308.....	157	RU 7792-245.....	158
RU 6420-09.....	151	RU 7584-20.....	86	RU 7791-310.....	157	RU 7792-250.....	158
RU 6420-10.....	151	RU 7585-12.....	87,256	RU 7791-315.....	157	RU 7792-260.....	158
RU 6420-11.....	151	RU 7585-15.....	87,256	RU 7791-318.....	157	RU 7792-270.....	158
RU 6420-12.....	151	RU 7586-00.....	77	RU 7791-323.....	157	RU 7793-040.....	159
RU 6420-15.....	151	RU 7586-07.....	77,87	RU 7791-327.....	157	RU 7793-050.....	159
RU 6420-56.....	151	RU 7586-08.....	77,87	RU 7791-330.....	157	RU 7793-060.....	159
RU 6420-58.....	151	RU 7587-07.....	77,87	RU 7791-335.....	157	RU 7793-080.....	159

**NUMMERNVERZEICHNIS
NUMERICAL INDEX**

RU 7793-250.....	159	RU 7806-06.....	186	RU 7825-02.....	190,192	RU 7843-02.....	197
RU 7793-260.....	159	RU 7806-60.....	186	RU 7825-03.....	190,192	RU 7843-03.....	197
RU 7793-280.....	159	RU 7807-02.....	187	RU 7826-00.....	190	RU 7843-04.....	197
RU 7793-440.....	159	RU 7807-03.....	187	RU 7827-00.....	190	RU 7843-05.....	197
RU 7793-450.....	159	RU 7807-05.....	187	RU 7828-00.....	191	RU 7843-06.....	197
RU 7793-460.....	159	RU 7807-06.....	187	RU 7829-00.....	191	RU 7843-07.....	197
RU 7793-480.....	159	RU 7807-30.....	187	RU 7830-05.....	192	RU 7844-01.....	196
RU 7793-800.....	159	RU 7807-40.....	187	RU 7830-06.....	192	RU 7844-02.....	196
RU 7793-810.....	159	RU 7809-03.....	187	RU 7830-08.....	192	RU 7844-03.....	196
RU 7801-01 NR.....	185	RU 7809-04.....	187	RU 7831-01.....	193	RU 7844-31.....	196
RU 7801-02 NR.....	185	RU 7809-05.....	187	RU 7831-02.....	193	RU 7844-32.....	196
RU 7801-03 NR.....	185	RU 7809-07.....	187	RU 7831-03.....	193	RU 7844-33.....	196
RU 7801-04 NR.....	185	RU 7809-09.....	187	RU 7831-04.....	193	RU 7844-44.....	196
RU 7801-05 NR.....	185	RU 7809-11.....	187	RU 7831-05.....	193	RU 7844-45.....	196
RU 7801-06 NR.....	185	RU 7809-20.....	187	RU 7831-06.....	193	RU 7844-47.....	196
RU 7801-07 NR.....	185	RU 7809-40.....	187	RU 7831-07.....	193	RU 7844-49.....	196
RU 7801-08 NR.....	185	RU 7810-12.....	187	RU 7832-05.....	193	RU 7844-55.....	196
RU 7801-09 NR.....	185	RU 7811-03.....	187	RU 7835-00.....	194	RU 7844-56.....	196
RU 7801-90 NR.....	185	RU 7811-04.....	187	RU 7836-00.....	194	RU 7844-68.....	196
RU 7802-02.....	185	RU 7811-05.....	187	RU 7840-20.....	195	RU 7844-70.....	196
RU 7802-02 NR.....	185	RU 7811-06.....	187	RU 7840-25.....	195	RU 7844-74.....	196
RU 7802-03.....	185	RU 7811-07.....	187	RU 7840-30.....	195	RU 7845-03.....	197
RU 7802-03 NR.....	185	RU 7811-08.....	187	RU 7840-40.....	195	RU 7845-05.....	197
RU 7802-04.....	185	RU 7811-40.....	187	RU 7840-50.....	195	RU 7845-07.....	197
RU 7802-04 NR.....	185	RU 7814-00.....	188	RU 7841-30.....	195	RU 7845-20.....	197
RU 7802-30.....	185	RU 7814-01.....	188	RU 7841-35.....	195	RU 7845-22.....	197
RU 7802-30 NR.....	185	RU 7814-06.....	188	RU 7841-40.....	195	RU 7845-24.....	197
RU 7803-01.....	186	RU 7814-07.....	188	RU 7841-45.....	195	RU 7846-35.....	197
RU 7803-02.....	186	RU 7814-08.....	188	RU 7841-50.....	195	RU 7846-37.....	197
RU 7803-03.....	176	RU 7814-50.....	188	RU 7842-00.....	195	RU 7846-40.....	197
RU 7803-04.....	186	RU 7814-51.....	188	RU 7842-00/05.....	195	RU 7846-43.....	197
RU 7803-30.....	186	RU 7814-99.....	188	RU 7842-00/10.....	195	RU 7846-45.....	197
RU 7803-40.....	186	RU 7815-00.....	189	RU 7842-00/20.....	195	RU 7846-50.....	197
RU 7804-02.....	186	RU 7815-01.....	189	RU 7842-00/21.....	195	RU 7846-55.....	197
RU 7804-02 NR.....	186	RU 7815-04.....	189	RU 7842-01.....	197	RU 7846-60.....	197
RU 7804-03.....	186	RU 7815-05.....	189	RU 7842-02.....	197	RU 7847-15.....	197
RU 7804-03 NR.....	186	RU 7815-06.....	189	RU 7842-03.....	197	RU 7847-20.....	197
RU 7804-04.....	186	RU 7815-07.....	189	RU 7842-10.....	197	RU 7848-00.....	198
RU 7804-04 NR.....	186	RU 7815-08.....	189	RU 7842-11.....	197	RU 7848-05.....	198
RU 7804-05.....	186	RU 7815-10.....	189	RU 7842-11/1.....	197	RU 7848-06.....	198
RU 7804-05 NR.....	186	RU 7815-12.....	189	RU 7842-12.....	197	RU 7848-07.....	198
RU 7804-06.....	186	RU 7815-16.....	189	RU 7842-12/1.....	197	RU 7848-09.....	198
RU 7804-06 NR.....	186	RU 7815-50.....	189	RU 7842-13.....	197	RU 7848-12.....	198
RU 7804-07.....	186	RU 7815-51.....	189	RU 7842-13/1.....	197	RU 7849-10.....	198
RU 7804-07 NR.....	186	RU 7815-52.....	189	RU 7842-14.....	197	RU 7849-15.....	198
RU 7804-20.....	186	RU 7815-66.....	189	RU 7842-18.....	197	RU 7849-18.....	198
RU 7804-20 NR.....	186	RU 7815-99.....	189	RU 7842-20.....	197	RU 7849-25.....	198
RU 7804-30.....	186	RU 7818-00.....	190	RU 7842-25.....	197	RU 7849-30.....	198
RU 7804-30 NR.....	186	RU 7820-00.....	190	RU 7842-30.....	197	RU 7849-45.....	198
RU 7804-40.....	186	RU 7820-01.....	190	RU 7842-50.....	197	RU 7850-16.....	199
RU 7804-40 NR.....	186	RU 7820-02.....	190,192	RU 7842-51.....	197	RU 7852-16.....	199
RU 7805-10.....	186	RU 7820-03.....	190,192	RU 7842-52.....	197	RU 7854-16.....	199
RU 7805-11.....	186	RU 7820-04.....	190,192	RU 7842-53.....	197	RU 7856-03.....	199,273
RU 7805-12.....	186	RU 7820-05.....	190,192	RU 7842-54.....	197	RU 7856-04.....	199,273
RU 7805-13.....	186	RU 7822-00.....	190	RU 7842-55.....	197	RU 7857-02.....	199
RU 7805-14.....	186	RU 7822-01.....	190	RU 7842-56.....	197	RU 7857-02/00.....	199
RU 7805-31.....	186	RU 7822-02.....	190	RU 7842-57.....	197	RU 7857-03.....	199
RU 7805-41.....	186	RU 7822-03.....	190	RU 7842-58.....	197	RU 7857-03/00.....	199
RU 7806-01.....	186	RU 7822-04.....	190	RU 7842-92.....	197	RU 7860-11.....	87,166,276
RU 7806-02.....	186	RU 7822-05.....	190	RU 7842-93.....	197	RU 7860-12.....	87,166,276
RU 7806-03.....	186	RU 7824-16.....	190	RU 7842-95.....	197	RU 7860-15.....	87,166,276
RU 7806-04.....	186	RU 7824-32.....	190,192	RU 7842-96.....	197	RU 7860-18.....	87,166,276
RU 7806-05.....	186	RU 7825-01.....	190,192	RU 7843-01.....	197	RU 7861-12.....	87,166

NUMMERNVERZEICHNIS
NUMERICAL INDEX

RU 7862-14	87,166	RU 7890-36.....	203	RU 7893-57.....	209	RU 7902-04.....	236
RU 7862-14/1	87,166	RU 7891-11.....	204	RU 7893-60/06	208	RU 7902-05.....	236
RU 7863-14	87,166	RU 7891-12.....	204	RU 7894-01.....	217	RU 7902-10	236
RU 7863-15	87,257	RU 7891-13.....	204	RU 7894-01/16.....	217	RU 7902-20	236
RU 7864-16	88,166	RU 7891-14.....	204	RU 7894-02.....	217	RU 7902-30	236
RU 7864-16	257,276	RU 7891-31	204	RU 7894-02/16.....	217	RU 7903-01.....	236
RU 7864-16/1	88,166	RU 7891-32	204	RU 7894-03.....	217	RU 7903-02.....	236
RU 7864-16/1	257,276	RU 7891-33	204	RU 7894-03/16.....	217	RU 7903-03.....	236
RU 7864-18	88,166	RU 7891-34	204	RU 7894-11	217	RU 7903-04.....	236
RU 7864-18	257,276	RU 7891-35.....	204	RU 7894-11/16.....	217	RU 7903-05.....	236
RU 7864-18/1	88,166	RU 7891-36.....	204	RU 7894-12	217	RU 7903-10	236
RU 7864-18/1	257,276	RU 7891-45.....	204	RU 7894-12/16	217	RU 7903-20	236
RU 7864-20	88,166	RU 7891-46	204	RU 7894-13/16	217	RU 7903-30	236
RU 7864-20	257,276	RU 7891-47	204	RU 7894-21	217	RU 7904-01.....	236
RU 7864-20/1.....	88,166	RU 7891-49.....	204	RU 7894-21/16	217	RU 7904-02.....	236
RU 7864-20/1.....	257,276	RU 7891-50.....	204	RU 7894-22.....	217	RU 7904-03.....	236
RU 7865-16	88,166	RU 7891-51	204	RU 7894-22/16.....	217	RU 7904-04.....	236
RU 7865-16	276	RU 7891-52	204	RU 7894-23.....	217	RU 7904-05.....	236
RU 7865-20	88,166	RU 7891-53.....	204	RU 7894-23/16.....	217	RU 7904-10	236
RU 7865-20	276	RU 7892-11.....	205	RU 7894-24	217	RU 7904-20	236
RU 7866-12	166	RU 7892-11/00	205	RU 7894-24/16.....	217	RU 7904-30.....	236
RU 7869-12	200	RU 7892-11/01.....	205	RU 7894-31	217	RU 7906-01/01.....	222
RU 7870-12	200	RU 7892-11/02	205	RU 7894-33.....	217	RU 7906-01/02.....	222
RU 7870-14	200	RU 7892-11/03	205	RU 7894-34.....	217	RU 7906-01/03.....	222
RU 7871-14	200	RU 7892-11/04	205	RU 7894-35.....	217	RU 7906-01/04.....	222
RU 7872-00	200	RU 7892-11/13.....	205	RU 7894-60/01.....	218	RU 7906-01/05.....	222
RU 7873-00.....	200	RU 7892-12	205	RU 7894-60/02	218	RU 7906-01/06.....	223
RU 7878-00.....	201	RU 7892-13	205	RU 7894-60/03	218	RU 7906-01/07.....	223
RU 7879-00.....	201	RU 7892-14.....	205	RU 7894-60/04	218	RU 7906-01/08.....	223
RU 7880-09.....	201	RU 7892-15	205	RU 7894-60/05	218	RU 7906-02/01	223
RU 7880-14	201	RU 7892-16	205	RU 7894-60/10.....	218	RU 7906-02/02	223
RU 7881-09.....	201	RU 7892-17.....	205	RU 7894-60/11	218	RU 7906-02/03	223
RU 7881-14.....	201	RU 7892-18	205	RU 7894-60/15.....	218	RU 7906-02/04	223
RU 7882-20	201	RU 7893-01/04.....	206	RU 7894-60/16.....	218	RU 7906-03/10	224
RU 7882-25	201	RU 7893-01/06.....	206	RU 7894-61/01	219	RU 7906-03/14.....	224
RU 7882-30	201	RU 7893-01/08.....	206	RU 7894-61/02	219	RU 7906-03/16.....	224
RU 7883-09	201	RU 7893-02/04	206	RU 7894-61/06.....	219	RU 7906-03/20	224
RU 7883-09/02	201	RU 7893-03/04	206	RU 7894-61/07.....	219	RU 7906-03/23	224
RU 7884-09.....	202,279,353	RU 7893-09/04	206	RU 7894-61/08.....	219	RU 7906-03/26	224
RU 7884-10	202,279,353	RU 7893-11/04	206	RU 7894-61/12	219	RU 7906-03/28	224
RU 7884-11	202,279,353	RU 7893-11/06	206	RU 7894-61/16.....	219	RU 7906-03/30	224
RU 7885-09.....	202	RU 7893-14	209,216	RU 7894-62/01.....	220	RU 7906-04/10.....	224
RU 7886-09.....	202	RU 7893-21/04.....	207	RU 7894-62/02	220	RU 7906-04/15.....	224
RU 7887-06.....	202	RU 7893-22/04.....	207	RU 7894-62/03	220	RU 7906-04/20	224
RU 7887-08.....	202	RU 7893-23/04.....	207	RU 7894-62/08	220	RU 7906-04/23	224
RU 7888-01.....	202	RU 7893-24/04.....	207	RU 7894-62/09	220	RU 7906-04/25	224
RU 7888-02.....	202	RU 7893-25/04.....	207	RU 7894-62/10.....	220	RU 7906-05/10.....	224
RU 7889-00.....	202	RU 7893-31/04.....	207	RU 7894-62/14.....	220	RU 7906-05/15.....	224
RU 7889-01.....	202	RU 7893-41/03.....	207	RU 7895-10	184,365	RU 7906-05/20	224
RU 7890-21	203	RU 7893-41/04.....	207	RU 7895-20	184,365	RU 7906-05/23	224
RU 7890-22.....	203	RU 7893-42/03	207	RU 7895-30.....	184,365	RU 7906-05/25	224
RU 7890-22/10.....	203	RU 7893-42/04	207	RU 7896-15	184,365	RU 7906-06/30	225
RU 7890-23.....	203	RU 7893-43/03	207	RU 7900-01	236	RU 7906-07/16.....	225
RU 7890-24	203	RU 7893-43/04	207	RU 7900-02.....	236	RU 7906-08/17.....	225
RU 7890-25.....	203	RU 7893-44/03	207	RU 7900-03.....	236	RU 7906-09/16.....	225
RU 7890-26.....	203	RU 7893-44/04	207	RU 7900-04.....	236	RU 7906-10/16	225
RU 7890-27	203	RU 7893-45/03	207	RU 7900-05.....	236	RU 7907-01/01	226
RU 7890-28.....	203	RU 7893-45/04	207	RU 7900-10	236	RU 7907-01/02	226
RU 7890-29.....	203	RU 7893-50/01.....	208	RU 7900-20.....	236	RU 7907-01/03	226
RU 7890-31	203	RU 7893-50/02.....	208	RU 7900-30.....	236	RU 7907-01/04	226
RU 7890-32.....	203	RU 7893-52.....	208	RU 7902-01.....	236	RU 7907-02/02.....	226
RU 7890-33.....	203	RU 7893-55.....	209	RU 7902-02.....	236	RU 7907-02/06.....	226
RU 7890-35.....	203	RU 7893-56.....	209	RU 7902-03.....	236	RU 7907-03/03.....	226

NUMMERNVERZEICHNIS
NUMERICAL INDEX

RU 7907-03/06.....	226	RU 7908-04/05	229	RU 7922-18	236	RU 7951-12.....	216
RU 7907-03/10.....	226	RU 7908-04/06	229	RU 7932-01	236	RU 7951-20.....	216
RU 7907-04/03.....	226	RU 7908-06/35	229	RU 7932-02	236	RU 7951-21	216
RU 7907-04/04.....	226	RU 7908-06/40	229	RU 7932-03.....	236	RU 7951-22	216
RU 7907-04/06.....	226	RU 7908-06/45	229	RU 7933-00.....	236	RU 7951-23	216
RU 7907-04/08.....	226	RU 7908-06/50	229	RU 7933-01	236	RU 7951-24	216
RU 7907-04/10.....	226	RU 7908-07/16.....	230	RU 7933-02.....	236	RU 7951-25	216
RU 7907-04/12.....	226	RU 7908-08/02.....	230	RU 7934-01.....	237	RU 7951-26.....	216
RU 7907-04/15.....	226	RU 7908-10/16.....	230	RU 7935-01.....	237	RU 7951-27	216
RU 7907-04/20.....	226	RU 7908-12/04.....	230	RU 7936-01.....	237	RU 7951-28	216
RU 7907-04/25.....	226	RU 7908-12/06.....	230	RU 7938-11	237	RU 7951-29	216
RU 7907-05/03.....	226	RU 7908-12/08.....	230	RU 7939-16	237	RU 7951-30	216
RU 7907-05/04.....	226	RU 7908-14/02.....	230	RU 7940-16	237	RU 7951-31	216
RU 7907-05/06.....	226	RU 7908-16/16.....	230	RU 7945-01.....	237	RU 7951-32.....	216
RU 7907-05/08.....	226	RU 7908-18/16.....	230	RU 7945-02.....	237	RU 7951-40	216
RU 7907-05/10.....	226	RU 7908-20/02.....	230	RU 7945-03.....	237	RU 7951-41	216
RU 7907-05/12.....	226	RU 7908-22/01.....	230	RU 7946-01.....	237	RU 7951-42	216
RU 7907-05/15.....	226	RU 7908-22/02.....	230	RU 7946-02.....	237	RU 7951-43	216
RU 7907-05/20.....	226	RU 7908-24/01.....	231,308	RU 7946-03.....	237	RU 7951-44	216
RU 7907-05/25.....	226	RU 7908-26/03.....	231	RU 7946-04.....	237	RU 7951-45.....	216
RU 7907-06/05.....	226	RU 7908-30/25	231	RU 7946-05.....	237	RU 7955-13	178
RU 7907-06/10.....	226	RU 7908-32/01	231	RU 7946-06.....	237	RU 7960-16	238
RU 7907-07/16	227	RU 7908-34/18.....	231	RU 7947-03	237	RU 7960-16/01	238
RU 7907-08/03.....	227	RU 7908-38/16.....	231	RU 7949-01	237	RU 7962-01	238
RU 7907-08/04.....	227	RU 7908-40/32	231	RU 7949-02.....	237	RU 7962-02.....	238
RU 7907-08/05.....	227	RU 7908-42/30	231	RU 7950-01	237	RU 7962-03.....	238
RU 7907-08/06.....	227	RU 7909-01/01.....	232	RU 7950-01/01	210	RU 7963-01	238
RU 7907-09/45.....	227	RU 7909-01/03.....	232	RU 7950-01/02.....	210	RU 7963-02.....	238
RU 7907-09/90	227	RU 7909-08/00	232	RU 7950-01/03.....	210	RU 7963-03.....	238
RU 7907-10/03	227	RU 7909-10/10.....	232	RU 7950-01/04.....	210	RU 7964-17	238
RU 7907-10/06	227	RU 7909-10/15	232	RU 7950-01/05.....	210	RU 7966-01.....	238
RU 7907-10/10.....	227	RU 7909-11/10	232	RU 7950-02/01	210	RU 7967-15.....	238
RU 7907-11/03.....	227	RU 7909-11/15	232	RU 7950-02/02	210	RU 7968-01	238
RU 7907-11/06.....	227	RU 7909-12/15.....	232	RU 7950-02/03	210	RU 7968-02.....	238
RU 7907-11/10.....	227	RU 7909-30/00	233	RU 7950-02/04	210	RU 7968-15	238
RU 7907-12/05	227	RU 7910-01	234	RU 7950-10/01	210	RU 7970-15	238
RU 7907-12/10.....	227	RU 7910-02.....	234	RU 7950-10/02	210	RU 7971-16.....	239
RU 7907-13/05	227	RU 7910-03.....	234	RU 7950-11/01	210	RU 7972-17.....	239
RU 7907-13/10.....	227	RU 7910-04.....	234	RU 7950-11/02	210	RU 7974-16.....	239
RU 7907-15/01	228	RU 7910-05.....	234	RU 7950-11/03	210	RU 7974-18.....	239
RU 7907-16/01	228	RU 7910-06.....	234	RU 7950-11/04	210	RU 7975-18	239
RU 7907-18/03	228	RU 7910-07.....	234	RU 7950-11/05	210	RU 7976-01	239
RU 7907-18/06	228	RU 7910-08.....	234	RU 7950-11/06	210	RU 7978-01	239
RU 7907-18/10.....	228	RU 7910-09.....	234	RU 7950-15/01	211	RU 7980-01.....	239
RU 7907-19/03	228	RU 7910-10	234	RU 7950-15/02	211	RU 7980-02.....	239
RU 7907-19/06	228	RU 7910-11.....	234	RU 7950-15/03	211	RU 7980-03.....	239
RU 7907-19/10.....	228	RU 7910-12.....	234	RU 7950-15/04	211	RU 7981-00	239
RU 7907-20/03	228	RU 7910-13.....	234	RU 7950-16/01	211	RU 7992-18	133
RU 7907-20/06	228	RU 7910-14.....	235	RU 7950-16/02	211	RU 7992-20	133
RU 7907-20/10	228	RU 7910-15.....	235	RU 7950-16/03.....	211	RU 7993-10	131,175
RU 7907-21/03	228	RU 7910-16	235	RU 7950-16/04	211	RU 7993-20.....	131,175
RU 7907-21/06	228	RU 7910-17.....	235	RU 7950-17/01	211	RU 7993-30.....	131,175
RU 7907-21/10	228	RU 7910-18.....	235	RU 7950-17/02	211	RU 7993-40.....	131,175
RU 7908-01/01.....	229	RU 7910-19	235	RU 7950-20/01.....	211	RU 7993-50.....	131,175
RU 7908-01/02.....	229	RU 7910-20	235	RU 7950-20/02.....	211	RU 7994-00.....	240
RU 7908-01/03.....	229	RU 7910-21	235	RU 7950-20/03.....	211	RU 7994-01	240
RU 7908-01/04.....	229	RU 7910-22	235	RU 7950-20/04.....	211	RU 7994-02.....	240
RU 7908-02/15.....	229	RU 7910-23	235	RU 7950-21/01	211	RU 7994-08.....	240
RU 7908-02/25	229	RU 7910-24	235	RU 7950-21/02	211	RU 7994-11	240
RU 7908-04/01	229	RU 7915-13.....	236	RU 7950-21/03.....	211	RU 7994-13	240
RU 7908-04/02	229	RU 7916-01	236	RU 7951-01	216	RU 7994-20.....	240
RU 7908-04/03	229	RU 7916-02	236	RU 7951-02	216	RU 7995-00.....	240
RU 7908-04/04	229	RU 7921-15.....	236	RU 7951-11	216	RU 7995-03.....	240

NUMMERNVERZEICHNIS
NUMERICAL INDEX

RU 7995-15	240	RU 8012-50	264	RU 8026-10	275	RU 8090-04	282
RU 7995-17	240	RU 8012-51	264	RU 8026-36	275	RU 8090-04 PC	282
RU 7995-22	240	RU 8012-75	264	RU 8027-00	275	RU 8090-04 TI	283
RU 7995-50	240	RU 8012-76	264	RU 8027-06	275	RU 8090-04 TI/CR	283
RU 7996-00	240	RU 8012-90	264	RU 8027-10	275	RU 8090-05	282
RU 7997-01	241	RU 8012-91	264	RU 8028-10	275	RU 8090-05 PC	282
RU 7997-02	241	RU 8012-95	264	RU 8029-01	276	RU 8090-05 TI	283
RU 7997-04	241	RU 8012-98	264	RU 8033-16	277	RU 8090-05 TI/CR	283
RU 7997-05	241	RU 8012-99	264	RU 8036-20	277	RU 8090-10	355
RU 7997-07	241	RU 8013-01	266	RU 8037-20	277	RU 8090-10 TI	355
RU 7997-10	241	RU 8013-02	266	RU 8050-16	277	RU 8090-10 TI /CR	355
RU 7997-50	242	RU 8013-03	266	RU 8050-20	277	RU 8090-11	355
RU 7997-51	242	RU 8013-04	266	RU 8058-18	277	RU 8090-11 TI	355
RU 7997-52	242	RU 8013-11	266	RU 8059-19	277	RU 8090-11 TI/CR	355
RU 7997-53	242	RU 8013-12	266	RU 8065-18	278	RU 8090-12	355
RU 7997-54	242	RU 8013-13	266	RU 8066-01	278	RU 8090-12 TI	355
RU 7997-55	242	RU 8013-14	266	RU 8066-02	278	RU 8090-12 TI/CR	355
RU 7997-56	242	RU 8013-83	267	RU 8072-01	278	RU 8090-20	284,356
RU 7997-57	242	RU 8013-85	267	RU 8072-02	278	RU 8090-22	284,356
RU 7997-58	242	RU 8013-36	268	RU 8073-01	278	RU 8090-22 L	356,284
RU 7997-59	242	RU 8013-51	268	RU 8073-02	278	RU 8090-22 R	284,356
RU 8000-01	261	RU 8013-76	268	RU 8074-01	279	RU 8090-22 SU	284,356
RU 8000-11	261	RU 8013-91	268	RU 8074-02	279	RU 8090-24	284, 356
RU 8000-02	261	RU 8014-36	269	RU 8074-03	279	RU 8091-00	282
RU 8000-12	261	RU 8014-51	269	RU 8074-04	279	RU 8091-00 P	282
RU 8000-03	261	RU 8014-76	269	RU 8079-01	279	RU 8091-00 TI	283
RU 8000-13	261	RU 8014-91	269	RU 8080-00	280,353	RU 8091-00 TI/CR	283
RU 8002-00	261	RU 8015-36	269	RU 8080-00 P	280,353	RU 8091-01	282
RU 8002-10	261	RU 8015-51	269	RU 8080-02	280,353	RU 8091-01 PC	282
RU 8002-01	261	RU 8015-76	269	RU 8080-03	280,353	RU 8091-01 TI	283
RU 8002-11	261	RU 8015-91	269	RU 8080-10	280,353	RU 8091-01 TI/CR	283
RU 8002-02	261	RU 8016-36	269	RU 8080-12	280,353	RU 8091-02	282
RU 8002-12	261	RU 8016-36B	269	RU 8081-00	280,353	RU 8091-02 PC	282
RU 8002-03	261	RU 8016-46	269	RU 8081-00 P	280,353	RU 8091-02 TI	283
RU 8002-13	261	RU 8016-46B	269	RU 8082-01	280	RU 8091-02 TI/CR	283
RU 8004-01	262	RU 8016-51	269	RU 8082-02	280	RU 8091-03	282
RU 8004-11	262	RU 8016-51B	269	RU 8082-03	280	RU 8091-03 P	282
RU 8004-02	262	RU 8016-76	269	RU 8083-01	280	RU 8091-03 TI	283
RU 8004-12	262	RU 8016-76B	269	RU 8084-01	280	RU 8091-03 TI/CR	283
RU 8005-00	262	RU 8017-83	272	RU 8084-02	280	RU 8091-04	282
RU 8005-01	262	RU 8017-86	272	RU 8085-01	281,354	RU 8091-04 TI	283
RU 8005-02	262	RU 8017-85	272	RU 8085-02	281,354	RU 8091-04 TI/CR	283
RU 8005-03	262	RU 8017-87	272	RU 8085-03	281,354	RU 8091-05	282
RU 8009-00	262	RU 8018-00	272	RU 8086-00	281,354	RU 8091-05 TI	283
RU 8010-01	263	RU 8018-01	272	RU 8087-00	281	RU 8091-05 TI/CR	283
RU 8010-02	263	RU 8018-02	272	RU 8089-00	281,354	RU 8091-10	355
RU 8010-03	263	RU 8018-03	272	RU 8089-01	281,354	RU 8091-10 TI	355
RU 8011-11	263	RU 8020-26	273	RU 8090-00	282	RU 8091-10 TI/CR	355
RU 8011-12	263	RU 8020-50	273	RU 8090-00 P	282	RU 8091-11	355
RU 8012-61	271	RU 8020-55	273	RU 8090-00 TI	283	RU 8091-11 TI	355
RU 8012-62	271	RU 8021-26	273	RU 8090-00 TI/CR	283	RU 8091-11 TI/CR	355
RU 8012-63	271	RU 8021-50	273	RU 8090-01	282	RU 8091-12	355
RU 8012-64	271	RU 8021-55	273	RU 8090-01 P	282	RU 8091-12 TI	355
RU 8012-336	264	RU 8022-24	273	RU 8090-01 TI	283	RU 8091-12 TI/CR	355
RU 8012-351	264	RU 8024-10	273,403	RU 8090-01 TI/CR	283	RU 8091-20	284,356
RU 8012-376	264	RU 8024-10/00	273,403	RU 8090-02	282	RU 8091-22	284,356
RU 8012-391	264	RU 8024-11	273	RU 8090-02 P	282	RU 8091-22 SU	284,356
RU 8012-83	265	RU 8024-11/00	273	RU 8090-02 TI	283	RU 8091-24	284,356
RU 8012-85	265	RU 8025-01	274	RU 8090-02 TI/CR	283	RU 8092-00	282
RU 8012-451	264	RU 8025-02	274	RU 8090-03	282	RU 8092-00 TI	283
RU 8012-551	264	RU 8025-03	274	RU 8090-03 PC	282	RU 8092-00 TI/CR	283
RU 8012-35	264	RU 8025-12	274	RU 8090-03 TI	283	RU 8092-01	282
RU 8012-36	264	RU 8026-00	275	RU 8090-03 TI/CR	283	RU 8092-01 TI	283

NUMMERNVERZEICHNIS
NUMERICAL INDEX

RU 8092-01 TI/CR	283	RU 8112-53.....	358	RU 8171-19.....	289	RU 8242-01	370
RU 8092-02.....	282	RU 8112-60.....	359	RU 8180-01.....	369	RU 8243-04.....	297
RU 8092-02 TI.....	283	RU 8112-61.....	359	RU 8180-02.....	369	RU 8243-06.....	297
RU 8092-02 TI/CR	283	RU 8112-70.....	360	RU 8181-00.....	353	RU 8243-08.....	297
RU 8092-03.....	282	RU 8112-71.....	360	RU 8185-01.....	369	RU 8244-16	297
RU 8092-03 TI.....	283	RU 8112-72.....	360	RU 8185-02.....	369	RU 8245-16	297
RU 8092-03 TI/CR	283	RU 8112-73.....	360	RU 8185-03.....	369	RU 8246-15	297
RU 8092-04.....	282	RU 8112-80	361	RU 8186-01.....	369	RU 8247-02	297
RU 8092-04 TI.....	283	RU 8113-01	361	RU 8186-02.....	369	RU 8247-04	297
RU 8092-04 TI/CR	283	RU 8113-02.....	361	RU 8186-03.....	369	RU 8247-06	297
RU 8092-05.....	282	RU 8113-03	361	RU 8186-04.....	369	RU 8247-08	297
RU 8092-05 TI.....	283	RU 8114-01.....	362	RU 8186-05.....	369	RU 8248-02.....	297
RU 8092-05 TI/CR	283	RU 8114-01/03	362	RU 8187-01.....	369	RU 8248-03.....	297
RU 8092-10.....	355	RU 8114-02	362	RU 8200-03.....	290	RU 8248-04.....	297
RU 8092-10 TI	355	RU 8114-02/03	362	RU 8200-04.....	290	RU 8248-05.....	297
RU 8092-10 TI/CR.....	355	RU 8114-03	362	RU 8200-05.....	290	RU 8248-06.....	297
RU 8092-11	355	RU 8114-03/03	362	RU 8201-03.....	290	RU 8248-07	297
RU 8092-11 TI	355	RU 8114-04	362	RU 8201-04.....	290	RU 8248-08.....	297
RU 8092-11 TI/CR.....	355	RU 8114-04/03	362	RU 8201-05.....	290	RU 8248-09.....	297
RU 8092-12.....	355	RU 8114-05.....	362	RU 8202-16	290	RU 8248-10	297
RU 8092-12 TI	355	RU 8114-05/03	362	RU 8203-03.....	291	RU 8248-11.....	297
RU 8092-12 TI/CR.....	355	RU 8114-06	362	RU 8203-04.....	291	RU 8248-12	297
RU 8093-01.....	357	RU 8114-06/03	362	RU 8203-05.....	291	RU 8248-14	297
RU 8094-00.....	285,354	RU 8115-00	363	RU 8204-16	291	RU 8248-19.....	298
RU 8094-00/01	285,354	RU 8115-01.....	363	RU 8206-16	291	RU 8248-19/01	298
RU 8095-00.....	285,354	RU 8115-02	363	RU 8209-18	291	RU 8248-19/02	298
RU 8096-02.....	357	RU 8116-01	363	RU 8210-19	291	RU 8249-02.....	298
RU 8096-03	357	RU 8116-02.....	363	RU 8211-20.....	291	RU 8249-03.....	298
RU 8096-12	357	RU 8117-24	363	RU 8212-19.....	291	RU 8249-04.....	298
RU 8096-13	357	RU 8118-02	364	RU 8213-19.....	291	RU 8249-05.....	298
RU 8100-01.....	285	RU 8118-03.....	364	RU 8214-20.....	292	RU 8249-06.....	298
RU 8100-02.....	285	RU 8118-05	364	RU 8215-20.....	292	RU 8249-07.....	298
RU 8100-03.....	285	RU 8119-01	364	RU 8216-18	292	RU 8249-08.....	298
RU 8100-04.....	285	RU 8121-19.....	286	RU 8217-18.....	292	RU 8249-09.....	298
RU 8102-01	285,354	RU 8122-19.....	286	RU 8218-21	292	RU 8249-10	298
RU 8102-02	285,354	RU 8125-18.....	286	RU 8219-22.....	292	RU 8249-11.....	298
RU 8102-03	285,354	RU 8126-20.....	286	RU 8220-19.....	293	RU 8249-12.....	298
RU 8103-21	285	RU 8130-01	287,368	RU 8221-17.....	293	RU 8249-15	298
RU 8103-22	285	RU 8130-02.....	287,368	RU 8222-18	293	RU 8250-16	299
RU 8108-05.....	285	RU 8130-03.....	287,368	RU 8222-22.....	293	RU 8252-16	299
RU 8108-07	285	RU 8130-04.....	287,368	RU 8224-23	293	RU 8253-02.....	299
RU 8108-09.....	285	RU 8132-00	287,368	RU 8226-18	293	RU 8253-04.....	299
RU 8108-11.....	285	RU 8134-03.....	184,287,368	RU 8228-21.....	294	RU 8253-06.....	299
RU 8108-15	285	RU 8134-04.....	184,287,368	RU 8230-21	294	RU 8253-07.....	299
RU 8108-17.....	285	RU 8134-05.....	184,287,368	RU 8231-03.....	294	RU 8253-09.....	299
RU 8108-19	285	RU 8134-06.....	184,287,368	RU 8231-06.....	294	RU 8253-12	299
RU 8108-21	285	RU 8139-01	288	RU 8231-16.....	294	RU 8253-22	299
RU 8109-01	285	RU 8139-02.....	288	RU 8232-18	294	RU 8253-24	299
RU 8110-01	285	RU 8139-03.....	288	RU 8236-18.....	295	RU 8253-26.....	299
RU 8110-02	285	RU 8140-01	288	RU 8237-20	295	RU 8253-27	299
RU 8111-01	358	RU 8141-01.....	288	RU 8238-22.....	295	RU 8253-29.....	299
RU 8111-02.....	358	RU 8142-01	288	RU 8239-20.....	295	RU 8253-32.....	299
RU 8111-03.....	358	RU 8143-01	288	RU 8239-22.....	295	RU 8253-52.....	299
RU 8111-04.....	358	RU 8144-15.....	288	RU 8240-16	295	RU 8253-54.....	299
RU 8112-00.....	358	RU 8145-15.....	288	RU 8241-03.....	296	RU 8253-56.....	299
RU 8112-01	358	RU 8146-15.....	289	RU 8241-05.....	296	RU 8254-02.....	299
RU 8112-02	358	RU 8147-14.....	289	RU 8241-13.....	296	RU 8254-04.....	299
RU 8112-03	358	RU 8149-02.....	289	RU 8241-15.....	296	RU 8254-06.....	299
RU 8112-20.....	359	RU 8152-16.....	289	RU 8241-20	296	RU 8254-07.....	299
RU 8112-21.....	359	RU 8153-16.....	289	RU 8241-21.....	296	RU 8254-09.....	299
RU 8112-50.....	358	RU 8154-15.....	289	RU 8241-22.....	296	RU 8254-12	299
RU 8112-51.....	358	RU 8155-13.....	289	RU 8241-30	296	RU 8254-52.....	299
RU 8112-52.....	358	RU 8156-14.....	289	RU 8241-31	296	RU 8254-54.....	299

**NUMMERNVERZEICHNIS
NUMERICAL INDEX**

RU 8254-56.....	299	RU 8268-05/03	304	RU 8292-10	312	RU 8351-01	321
RU 8255-16/01	299	RU 8268-05/04	304	RU 8293-09	313	RU 8351-02	321
RU 8255-16/02	299	RU 8268-05/05	304	RU 8293-10	313	RU 8351-03	321
RU 8256-08.....	300	RU 8268-05/06	304	RU 8294-16	313	RU 8351-04	321
RU 8256-58.....	300	RU 8268-05/07	304	RU 8298-20.....	313	RU 8351-05	321
RU 8258-04.....	300	RU 8268-05/08	304	RU 8299-19	313	RU 8351-06	321
RU 8258-06.....	300	RU 8268-05/09	304	RU 8299-20.....	313	RU 8352-01	322
RU 8258-07.....	300	RU 8268-05/10.....	304	RU 8300-14	313	RU 8352-02	322
RU 8258-09.....	300	RU 8268-07/01	304	RU 8301-01	314	RU 8352-03.....	322
RU 8258-12	300	RU 8268-07/02.....	304	RU 8301-02.....	314	RU 8352-04.....	322
RU 8259-06.....	300	RU 8268-07/03.....	304	RU 8302-15	314	RU 8353-01.....	322
RU 8260-05.....	300	RU 8268-07/04.....	304	RU 8302-30.....	314	RU 8353-02.....	322
RU 8260-08.....	300	RU 8268-07/05.....	304	RU 8302-31.....	314	RU 8353-03.....	322
RU 8260-25.....	300	RU 8268-07/06.....	304	RU 8303-08.....	314	RU 8353-04.....	322
RU 8260-35.....	300	RU 8268-07/07.....	304	RU 8303-09.....	314	RU 8353-05.....	322
RU 8261-03.....	300	RU 8268-07/08.....	304	RU 8303-18	314	RU 8353-06.....	322
RU 8261-04	300	RU 8268-07/09.....	304	RU 8303-19	314	RU 8354-00	322
RU 8261-22	300	RU 8268-07/10.....	304	RU 8303-30.....	314	RU 8354-00/01	322
RU 8261-23	300	RU 8268-10/01	305	RU 8304-12	314	RU 8354-01	322
RU 8261-24	300	RU 8268-10/02	305	RU 8310-16	314	RU 8354-02.....	322
RU 8261-27	300	RU 8268-12/01	305	RU 8310-60.....	314	RU 8354-03.....	322
RU 8261-29	300	RU 8268-12/02.....	305	RU 8312-10.....	88,257,314	RU 8354-04.....	322
RU 8261-32	300	RU 8269-12	370	RU 8315-00.....	315	RU 8355-01.....	323
RU 8262-10	301	RU 8270-18	306	RU 8315-01	315	RU 8355-02.....	323
RU 8262-12	301	RU 8271-01	306	RU 8315-02	315	RU 8355-03.....	323
RU 8262-14	301	RU 8271-02	306	RU 8315-03.....	315	RU 8361-00.....	323
RU 8262-16	301	RU 8272-02.....	305	RU 8315-04.....	315	RU 8361-01	323
RU 8263-01.....	301	RU 8272-03.....	305	RU 8316-12	316	RU 8361-02	323
RU 8263-02.....	301	RU 8272-04.....	305	RU 8326-01.....	316	RU 8361-03.....	323
RU 8263-03.....	301	RU 8272-05.....	305	RU 8326-02.....	316	RU 8361-10.....	323
RU 8263-20.....	301	RU 8272-06.....	305	RU 8327-01	317	RU 8361-11.....	323
RU 8263-21.....	301	RU 8272-07	305	RU 8327-02	317	RU 8361-12.....	323
RU 8263-22.....	301	RU 8273-01.....	307	RU 8327-03.....	317	RU 8361-13.....	323
RU 8263-31.....	301	RU 8273-02.....	307	RU 8327-11.....	317	RU 8362-01	323
RU 8263-32.....	301	RU 8273-17	305	RU 8327-12.....	317	RU 8362-02.....	323
RU 8263-40.....	301	RU 8274-21	307	RU 8327-13.....	317	RU 8362-03.....	323
RU 8263-41.....	301	RU 8274-50.....	307	RU 8328-01.....	317	RU 8363-19	321,350
RU 8263-42.....	301	RU 8275-01.....	307	RU 8328-02.....	317	RU 8364-01	372
RU 8264-10	302	RU 8275-02.....	307	RU 8328-03.....	317	RU 8364-02.....	372
RU 8264-12	302	RU 8275-50.....	307	RU 8329-22.....	317	RU 8364-15	372
RU 8264-14	302	RU 8276-01.....	308	RU 8330-23.....	318	RU 8364-17	372
RU 8264-16	302	RU 8276-02.....	308	RU 8331-20.....	318	RU 8364-20.....	372
RU 8264-65.....	302	RU 8276-21	305	RU 8331-21	318	RU 8364-25.....	372
RU 8264-81.....	302	RU 8276-50.....	308	RU 8333-20.....	318	RU 8364-30.....	372
RU 8264-83.....	302	RU 8277-01.....	308	RU 8333-50.....	318	RU 8365-15	372
RU 8264-85.....	302	RU 8278-00.....	308	RU 8334-21.....	371	RU 8365-17	372
RU 8265-00.....	302	RU 8280-15.....	312	RU 8335-20.....	135,371	RU 8365-20.....	372
RU 8266-20.....	303	RU 8281-16.....	311	RU 8338-01.....	371	RU 8365-25.....	372
RU 8267-00.....	303	RU 8282-03.....	311	RU 8338-02.....	371	RU 8365-30.....	372
RU 8267-01	303	RU 8283-01.....	311	RU 8338-03.....	371	RU 8366-00 L.....	372
RU 8267-02	303	RU 8283-02.....	311	RU 8338-04.....	371	RU 8366-00 R.....	372
RU 8268-01/12.....	304	RU 8283-03.....	311	RU 8340-01.....	371	RU 8366-20.....	372
RU 8268-01/34.....	304	RU 8283-04.....	311	RU 8340-02.....	371	RU 8366-25.....	372
RU 8268-01/56.....	304	RU 8284-01.....	311	RU 8340-03.....	371	RU 8366-30.....	372
RU 8268-01/78.....	304	RU 8286-22.....	311 RU	RU 8340-04.....	371	RU 8367-20.....	372
RU 8268-01/99.....	304	8286-52.....	311	RU 8340-05.....	371	RU 8367-25	372
RU 8268-02/12.....	304	RU 8287-17.....	312	RU 8340-06.....	371	RU 8367-30.....	372
RU 8268-02/34	304	RU 8288-01.....	312	RU 8350-01.....	321	RU 8368-00.....	373
RU 8268-02/56	304	RU 8288-02.....	312	RU 8350-02.....	321	RU 8368-01.....	373
RU 8268-02/78	304	RU 8290-15.....	312	RU 8350-03.....	321	RU 8368-02.....	373
RU 8268-02/99	304	RU 8292-02.....	312	RU 8350-04.....	321	RU 8368-12.....	373
RU 8268-05/01	304	RU 8292-05.....	312	RU 8350-05.....	321	RU 8368-13	373
RU 8268-05/02	304	RU 8292-07.....	312	RU 8350-06.....	321	RU 8368-14	373

NUMMERNVERZEICHNIS
NUMERICAL INDEX

RU 8368-22.....	373	RU 8384-50.....	327	RU 8418-11.....	332	RU 8546-23.....	339
RU 8368-23.....	373	RU 8384-51.....	327	RU 8418-13.....	332	RU 8547-18.....	339
RU 8368-24.....	373	RU 8384-52.....	327	RU 8419-11.....	332	RU 8547-20.....	339
RU 8370-01.....	374	RU 8384-53.....	327	RU 8419-13.....	332	RU 8547-22.....	339
RU 8370-02.....	374	RU 8384-54.....	327	RU 8420-19.....	103,351	RU 8548-16.....	340
RU 8370-10.....	374	RU 8384-55.....	327	RU 8421-12.....	332,351	RU 8549-24.....	340
RU 8370-11.....	374	RU 8384-99.....	327	RU 8421-14.....	332,351	RU 8550-20.....	340
RU 8370-12.....	374	RU 8386-00.....	328	RU 8421-16.....	332,351	RU 8551-20.....	340
RU 8370-25.....	373	RU 8386-01.....	328	RU 8424-19.....	332	RU 8553-21.....	340
RU 8370-30.....	373	RU 8386-02.....	328	RU 8425-15.....	333	RU 8555-18.....	340
RU 8370-40.....	373	RU 8386-03.....	328	RU 8426-14.....	333	RU 8555-23.....	340
RU 8370-50.....	373	RU 8387-01.....	328	RU 8429-16.....	333	RU 8556-19.....	341
RU 8372-01.....	374	RU 8387-02.....	328	RU 8430-14.....	333	RU 8557-19.....	341
RU 8372-02.....	374	RU 8387-03.....	328	RU 8431-14.....	333	RU 8559-20.....	341
RU 8372-03.....	374	RU 8387-04.....	328	RU 8432-15.....	333	RU 8560-20.....	341
RU 8372-11.....	374	RU 8388-02.....	328	RU 8433-17.....	333	RU 8570-01.....	73,341
RU 8372-12.....	374	RU 8388-03.....	328	RU 8434-18.....	333	RU 8570-02.....	73,341
RU 8372-13.....	374	RU 8388-04.....	328	RU 8440-19.....	334	RU 8570-03.....	341
RU 8372-21.....	374	RU 8388-05.....	328	RU 8442-01.....	334	RU 8570-04.....	341
RU 8372-22.....	374	RU 8388-06.....	328	RU 8442-02.....	334	RU 8600-28.....	342
RU 8372-23.....	374	RU 8389-01.....	328	RU 8445-16.....	334	RU 8602-28.....	342
RU 8373-01.....	375	RU 8389-02.....	328	RU 8450-16.....	334	RU 8604-28.....	342
RU 8373-08.....	375	RU 8389-03.....	328	RU 8452-17.....	334	RU 8608-00.....	342
RU 8373-10.....	375	RU 8389-04.....	328	RU 8452-50.....	334	RU 8608-10.....	342
RU 8373-12.....	375	RU 8389-05.....	328	RU 8455-01.....	334	RU 8608-11.....	342
RU 8373-15.....	375	RU 8389-21.....	329	RU 8455-02.....	334	RU 8609-03.....	343
RU 8374-01.....	375	RU 8389-22.....	329	RU 8455-03.....	334	RU 8609-03/00.....	343
RU 8374-15.....	375	RU 8389-23.....	329	RU 8458-01.....	335	RU 8609-04.....	343
RU 8374-22.....	375	RU 8390-02.....	329	RU 8458-02.....	335	RU 8609-04/00.....	343
RU 8375-01.....	126,375	RU 8390-03.....	329	RU 8502-23.....	335	RU 8609-05.....	343
RU 8380-00.....	324	RU 8390-04.....	329	RU 8503-01.....	335	RU 8609-05/00.....	343
RU 8380-01.....	324	RU 8390-05.....	329	RU 8503-02.....	335	RU 8609-06.....	343
RU 8380-02.....	324	RU 8390-52.....	329	RU 8512-24.....	335	RU 8609-06/00.....	343
RU 8380-03.....	324	RU 8390-53.....	329	RU 8516-01.....	336	RU 8609-40.....	343
RU 8380-04.....	324	RU 8390-54.....	329	RU 8516-02.....	336	RU 8609-50.....	343
RU 8380-05.....	324	RU 8390-55.....	329	RU 8519-21.....	336	RU 8610-00.....	343
RU 8380-10.....	324	RU 8395-00.....	329	RU 8520-26.....	336	RU 8611-00.....	343
RU 8380-11.....	324	RU 8395-02.....	329	RU 8520-50.....	336	RU 8614-01.....	344
RU 8380-12.....	324	RU 8395-03.....	329	RU 8520-51.....	336	RU 8614-02.....	344
RU 8380-13.....	324	RU 8402-10.....	330	RU 8524-20.....	336	RU 8614-03.....	344
RU 8381-00.....	325	RU 8402-11.....	330	RU 8525-01.....	336	RU 8615-00.....	344
RU 8381-01.....	325	RU 8402-14.....	330	RU 8525-02.....	336	RU 8615-01.....	344
RU 8381-02.....	325	RU 8403-10.....	330	RU 8525-03.....	336	RU 8615-02.....	344
RU 8381-03.....	325	RU 8403-11.....	330	RU 8529-19.....	337	RU 8615-03.....	344
RU 8381-04.....	325	RU 8403-14.....	330	RU 8530-19.....	337	RU 8615-10.....	344
RU 8381-05.....	325	RU 8405-16.....	330	RU 8531-17.....	337	RU 8616-13.....	345
RU 8381-06.....	325	RU 8405-19.....	330	RU 8531-99.....	337	RU 8616-15.....	345
RU 8381-07.....	325	RU 8406-12.....	330	RU 8533-22.....	337	RU 8616-17.....	345
RU 8381-10.....	325	RU 8408-13.....	330	RU 8535-20.....	337	RU 8617-50.....	345
RU 8381-11.....	325	RU 8409-13.....	330	RU 8536-22.....	337	RU 8619-01/35.....	414
RU 8383-00.....	326	RU 8410-14.....	331	RU 8538-21.....	338	RU 8619-02/35.....	414
RU 8383-01.....	326	RU 8412-09.....	331	RU 8539-23.....	338	RU 8619-03/35.....	414
RU 8383-02.....	326	RU 8412-11.....	331	RU 8540-19.....	338	RU 8619-04/35.....	414
RU 8383-03.....	326	RU 8412-13.....	331	RU 8542-08.....	338	RU 8619-05/35.....	414
RU 8383-10.....	326	RU 8412-15.....	331	RU 8542-22.....	338	RU 8619-06/35.....	414
RU 8384-00.....	327	RU 8414-11.....	331	RU 8542-50.....	338	RU 8619-07/35.....	414
RU 8384-01.....	327	RU 8414-13.....	331	RU 8543-19.....	338	RU 8619-08/35.....	414
RU 8384-02.....	327	RU 8416-09.....	331	RU 8543-51.....	339	RU 8619-09/35.....	414
RU 8384-03.....	327	RU 8416-11.....	331	RU 8543-60.....	339	RU 8619-10/35.....	414
RU 8384-04.....	327	RU 8416-13.....	331	RU 8544-19.....	335	RU 8619-11/35.....	414
RU 8384-05.....	327	RU 8416-15.....	331	RU 8545-01.....	339	RU 8619-20/35.....	414
RU 8384-10.....	327	RU 8417-00.....	331	RU 8545-02.....	339	RU 8619-20/40.....	414
RU 8384-14.....	327	RU 8418-09.....	332	RU 8545-50.....	339	RU 8619-20/50.....	414

NUMMERNVERZEICHNIS
NUMERICAL INDEX

RU 8619-20/55.....414	RU 8619-81/01..... 415	RU 8649-03/03..... 397	RU 8650-11/01..... 400
RU 8619-20/60.....414	RU 8619-81/02..... 415	RU 8649-03/05..... 397	RU 8650-11/03..... 400
RU 8619-21/35.....414	RU 8619-81/03..... 415	RU 8649-03/06..... 397	RU 8650-11/05..... 400
RU 8619-21/40.....414	RU 8619-81/04..... 415	RU 8649-03/11..... 398	RU 8650-11/06..... 400
RU 8619-21/50.....414	RU 8619-81/05..... 415	RU 8649-03/21..... 399	RU 8650-11/11..... 400
RU 8619-21/55.....414	RU 8620-30.....416	RU 8649-03/23..... 399	RU 8650-11/13..... 400
RU 8619-21/60.....414	RU 8620-40.....416	RU 8649-04/01..... 397	RU 8650-11/15..... 400
RU 8619-22/35.....414	RU 8620-50.....416	RU 8649-04/03..... 397	RU 8650-11/16..... 400
RU 8619-22/40.....414	RU 8620-60.....416	RU 8649-04/05..... 397	RU 8650-11/21..... 400
RU 8619-22/50.....414	RU 8621-30.....416	RU 8649-04/06..... 397	RU 8650-11/23..... 400
RU 8619-22/55.....414	RU 8621-40.....416	RU 8649-04/11..... 398	RU 8650-11/25..... 400
RU 8619-22/60.....414	RU 8621-50.....416	RU 8649-04/21..... 399	RU 8650-11/26..... 400
RU 8619-23/35.....414	RU 8621-60.....416	RU 8649-04/23..... 399	RU 8650-11/30..... 400
RU 8619-23/40.....414	RU 8622-30.....416	RU 8649-05/21..... 399	RU 8650-11/31..... 400
RU 8619-23/50.....414	RU 8622-40.....416	RU 8649-05/23..... 399	RU 8650-12/01..... 400
RU 8619-23/55.....414	RU 8622-50.....416	RU 8649-06/21..... 399	RU 8650-12/03..... 400
RU 8619-23/60.....414	RU 8622-60.....416	RU 8649-06/23..... 399	RU 8650-12/05..... 400
RU 8619-24/35.....414	RU 8623-30.....416	RU 8649-11/23..... 400	RU 8650-12/06..... 400
RU 8619-24/40.....414	RU 8623-40.....416	RU 8649-12/23..... 400	RU 8650-12/11..... 400
RU 8619-24/50.....414	RU 8623-50.....416	RU 8650-00/40..... 396	RU 8650-12/13..... 400
RU 8619-24/55.....414	RU 8623-60.....416	RU 8650-00/43..... 396	RU 8650-12/15..... 400
RU 8619-24/60.....414	RU 8625-40.....416	RU 8650-00/45..... 396	RU 8650-12/16..... 400
RU 8619-30/35.....414	RU 8625-50.....416	RU 8650-00/46..... 396	RU 8650-12/21..... 400
RU 8619-30/40.....414	RU 8625-60.....416	RU 8650-03/01..... 397	RU 8650-12/23..... 400
RU 8619-30/50.....414	RU 8626-40.....416	RU 8650-03/02..... 397	RU 8650-12/25..... 400
RU 8619-30/55.....414	RU 8626-50.....416	RU 8650-03/03..... 397	RU 8650-12/26..... 400
RU 8619-30/60.....414	RU 8626-60.....416	RU 8650-03/04..... 397	RU 8650-12/30..... 400
RU 8619-31/35.....414	RU 8630-00..... 407	RU 8650-03/05..... 397	RU 8650-12/31..... 400
RU 8619-31/40.....414	RU 8632-20..... 407	RU 8650-03/06..... 397	RU 8651-01..... 401
RU 8619-31/50.....414	RU 8632-30..... 407	RU 8650-03/11..... 398	RU 8651-02..... 401
RU 8619-31/55.....414	RU 8632-40..... 407	RU 8650-03/13..... 398	RU 8651-05..... 401
RU 8619-31/60.....414	RU 8632-50..... 407	RU 8650-03/15..... 398	RU 8651-10..... 401
RU 8619-32/35.....414	RU 8632-60..... 407	RU 8650-03/16..... 398	RU 8651-11..... 401
RU 8619-32/40.....414	RU 8633-20..... 407	RU 8650-03/18..... 398	RU 8651-20..... 401
RU 8619-32/50.....414	RU 8633-30..... 407	RU 8650-03/19..... 398	RU 8651-21..... 401
RU 8619-32/55.....414	RU 8633-40..... 407	RU 8650-03/21..... 399	RU 8651-40..... 401
RU 8619-32/60.....414	RU 8633-50..... 407	RU 8650-03/23..... 399	RU 8652-00..... 404
RU 8619-33/35.....414	RU 8633-60..... 407	RU 8650-03/25..... 399	RU 8652-07..... 402
RU 8619-33/40.....414	RU 8634-20..... 407	RU 8650-03/26..... 399	RU 8652-08..... 402
RU 8619-33/50.....414	RU 8636-01..... 408	RU 8650-03/30..... 399	RU 8652-11..... 402
RU 8619-33/55.....414	RU 8637-01..... 408	RU 8650-03/31..... 399	RU 8652-12..... 402
RU 8619-33/60.....414	RU 8639-01..... 408	RU 8650-03/32..... 399	RU 8652-13..... 402
RU 8619-70/01..... 415	RU 8639-02..... 408	RU 8650-03/33..... 399	RU 8652-14..... 403
RU 8619-70/02..... 415	RU 8639-02/04..... 408	RU 8650-04/01..... 397	RU 8652-15..... 403
RU 8619-70/03..... 415	RU 8639-03..... 408	RU 8650-04/02..... 397	RU 8652-21..... 404
RU 8619-70/04..... 415	RU 8639-03/03..... 408	RU 8650-04/03..... 397	RU 8652-22..... 404
RU 8619-71/01..... 415	RU 8639-03/04..... 408	RU 8650-04/04..... 397	RU 8652-23..... 404
RU 8619-71/02..... 415	RU 8639-04..... 408	RU 8650-04/05..... 397	RU 8652-24..... 404
RU 8619-71/03..... 415	RU 8639-04/03..... 408	RU 8650-04/06..... 397	RU 8652-25..... 404
RU 8619-71/04..... 415	RU 8639-04/04..... 408	RU 8650-04/11..... 398	RU 8652-26..... 404
RU 8619-72/01..... 415	RU 8641-01..... 408	RU 8650-04/13..... 398	RU 8652-27..... 404
RU 8619-72/02..... 415	RU 8641-02..... 408	RU 8650-04/15..... 398	RU 8652-28..... 404
RU 8619-72/03..... 415	RU 8642-01..... 408	RU 8650-04/16..... 398	RU 8652-29..... 404
RU 8619-72/04..... 415	RU 8642-02..... 408	RU 8650-04/18..... 398	RU 8652-30..... 404
RU 8619-73/01..... 415	RU 8643-01..... 408	RU 8650-04/19..... 398	RU 8652-31..... 404
RU 8619-73/02..... 415	RU 8643-02..... 408	RU 8650-04/21..... 399	RU 8652-32..... 404
RU 8619-73/03..... 415	RU 8643-03..... 408	RU 8650-04/23..... 399	RU 8652-33..... 404
RU 8619-73/04..... 415	RU 8643-04..... 408	RU 8650-04/25..... 399	RU 8652-34..... 404
RU 8619-80/01..... 415	RU 8644-01..... 408	RU 8650-04/26..... 399	RU 8652-35..... 404
RU 8619-80/02..... 415	RU 8645-01..... 408	RU 8650-04/30..... 399	RU 8653-00..... 403
RU 8619-80/03..... 415	RU 8645-02..... 408	RU 8650-04/31..... 399	RU 8655-00..... 403
RU 8619-80/04..... 415	RU 8648-01..... 408	RU 8650-04/32..... 399	RU 8660-06..... 409
RU 8619-80/05..... 415	RU 8649-03/01..... 397	RU 8650-04/33..... 399	RU 8660-08..... 409

**NUMMERNVERZEICHNIS
NUMERICAL INDEX**

RU 8660-10.....	409	RU 8865-00.....	421	RU 8904-06/01.....	426	RU 8984-05.....	430
RU 8660-12.....	409	RU 8865-51.....	419	RU 8904-07/01.....	26	RU 8984-06.....	430
RU 8660-14.....	409	RU 8865-52.....	419	RU 8904-08/01.....	426	RU 8984-07.....	430
RU 8660-16.....	409	RU 8865-55.....	419	RU 8904-09/01.....	426	RU 8985-00/01.....	430
RU 8660-18.....	409	RU 8865-56.....	419	RU 8905-01/01.....	428	RU 8985-00/02.....	430
RU 8660-20.....	409	RU 8865-59.....	419	RU 8905-50/08.....	428	RU 8985-01.....	430
RU 8660-22.....	409	RU 8865-60.....	419	RU 8905-50/11.....	428	RU 8985-02.....	430
RU 8660-24.....	409	RU 8867-05.....	418	RU 8907-01/01.....	424-426	RU 8985-03.....	430
RU 8660-26.....	409	RU 8867-06.....	418	RU 8907-01/02.....	424-426	RU 8985-04.....	430
RU 8660-28.....	409	RU 8867-07.....	418	RU 8907-01/03.....	424-426	RU 8985-05.....	430
RU 8660-30.....	409	RU 8867-08.....	418	RU 8907-01/04.....	424-426	RU 8985-06.....	430
RU 8662-06.....	409	RU 8867-11.....	418	RU 8907-01/05.....	424-426	RU 9012-07.....	272
RU 8662-08.....	409	RU 8867-12.....	418	RU 8907-01/06.....	424-426	RU 9405-13.....	309
RU 8662-10.....	409	RU 8867-33.....	419	RU 8907-01/07.....	424-426	RU 9406-13.....	309
RU 8662-12.....	409	RU 8867-34.....	419	RU 8907-01/08.....	424-426	RU 9576-01.....	36
RU 8662-14.....	409	RU 8867-36.....	419	RU 8907-01/09.....	424-426	RU 9576-02.....	36
RU 8662-16.....	409	RU 8867-37.....	419	RU 8907-02/01.....	428	RU 9576-10.....	36
RU 8662-18.....	409	RU 8867-40.....	419	RU 8908-01.....	422	RU 9576-21.....	36
RU 8662-20.....	409	RU 8867-41.....	419	RU 8908-02.....	422	RU 9576-22.....	36
RU 8662-22.....	409	RU 8867-42.....	419	RU 8908-11.....	422	RU 9576-23.....	36
RU 8662-24.....	409	RU 8867-43.....	419	RU 8908-12.....	422	RU 9576-24.....	36
RU 8662-26.....	409	RU 8867-44.....	419	RU 8909-05.....	422	RU 9576-25.....	36
RU 8662-28.....	409	RU 8867-45.....	419	RU 8909-07.....	422	RU 9576-31.....	36
RU 8662-30.....	409	RU 8867-46.....	419	RU 8909-08.....	422	RU 9576-32.....	36
RU 8664-10.....	409	RU 8867-47.....	419	RU 8909-10.....	422	RU 9576-33.....	36
RU 8664-12.....	409	RU 8867-51.....	419	RU 8909-11.....	422	RU 9576-34.....	36
RU 8664-14.....	409	RU 8867-52.....	419	RU 8909-12.....	422	RU 9576-35.....	36
RU 8664-16.....	409	RU 8871-14HP.....	420	RU 8914-00.....	429	RU 9577-00.....	37
RU 8664-18.....	409	RU 8876-10.....	420	RU 8915-01.....	31	RU 9577-02.....	37
RU 8664-40.....	409	RU 8879-10.....	420	RU 8915-02.....	31	RU 9577-05.....	37
RU 8664-42.....	409	RU 8879-12.....	420	RU 8915-03.....	31	RU 9577-10.....	37
RU 8664-44.....	409	RU 8880-00.....	421	RU 8915-04.....	31	RU 9577-11.....	37
RU 8664-46.....	409	RU 8880-03.....	421	RU 8916-01.....	429	RU 9577-12.....	37
RU 8664-48.....	409	RU 8880-05.....	421	RU 8916-11.....	429	RU 9577-13.....	37
RU 8666-01.....	409	RU 8880-06.....	421	RU 8946-23.....	420	RU 9577-14.....	37
RU 8666-02.....	409	RU 8880-07.....	421	RU 8966-01.....	429	RU 9577-21.....	37
RU 8680-18.....	411	RU 8880-50.....	421	RU 8966-11.....	429	RU 9577-22.....	37
RU 8688-01.....	410	RU 8880-60.....	421	RU 8967-10.....	429	RU 9577-23.....	37
RU 8688-02.....	410	RU 8880-61.....	421	RU 8967-12.....	429	RU 9577-24.....	37
RU 8688-03.....	410	RU 8882-01.....	208	RU 8970-01.....	241,429	RU 9577-25.....	37
RU 8688-04.....	410	RU 8902-01.....	424	RU 8970-02.....	241,429	RU 9577-27.....	37
RU 8689-01.....	410	RU 8902-02.....	424	RU 8970-03.....	241,429	RU 9577-28.....	37
RU 8690-01.....	411	RU 8902-03.....	424	RU 8975-05.....	430	RU 9577-29.....	37
RU 8690-02.....	411	RU 8902-04.....	424	RU 8975-10.....	430	RU 9577-30.....	37
RU 8690-03.....	411	RU 8902-05.....	424	RU 8981-02.....	430	RU 9577-31.....	37
RU 8690-04.....	411	RU 8902-06.....	424	RU 8981-03.....	430	RU 9577-34.....	37
RU 8692-24.....	411	RU 8902-07.....	424	RU 8981-04.....	430	RU 9577-35.....	37
RU 8695-20.....	411	RU 8902-08.....	424	RU 8981-05.....	430	RU 9577-36.....	37
RU 8822-06.....	310	RU 8902-09.....	424	RU 8981-06.....	430	RU 9577-37.....	37
RU 8826-00.....	310	RU 8903-01.....	425	RU 8981-12.....	430	RU 9577-41.....	37
RU 8826-01.....	310	RU 8903-02.....	425	RU 8981-13.....	430	RU 9577-45.....	37
RU 8826-02.....	311	RU 8903-03.....	425	RU 8981-14.....	430	RU 9577-46.....	37
RU 8826-03.....	311	RU 8903-04.....	425	RU 8981-15.....	430	RU 9577-47.....	37
RU 8831-10.....	310	RU 8903-05.....	425	RU 8981-16.....	430	RU 9630-01.....	111
RU 8831-18.....	310	RU 8903-06.....	425	RU 8981-22.....	430	RU 9630-02.....	111
RU 8835-13.....	310	RU 8903-07.....	425	RU 8981-23.....	430	RU 9630-03.....	111
RU 8860-01.....	221	RU 8903-08.....	425	RU 8981-24.....	430	RU 9651-00.....	111
RU 8860-02.....	221	RU 8903-09.....	425	RU 8981-25.....	430	RU 9651-00/2.....	111
RU 8861-01.....	221	RU 8904-01/01.....	426	RU 8981-26.....	430	RU 9651-00/3.....	111
RU 8861-02.....	221	RU 8904-02/01.....	426	RU 8984-01.....	430	RU 9651-01.....	111
RU 8861-03.....	221	RU 8904-03/01.....	426	RU 8984-02.....	430	RU 9651-12.....	111
RU 8862-01.....	221	RU 8904-04/01.....	426	RU 8984-03.....	430	RU 9651-23.....	111
RU 8862-02.....	221	RU 8904-05/01.....	426	RU 8984-04.....	430	RU 9651-34.....	111

NUMMERNVERZEICHNIS
NUMERICAL INDEX

RU 9651-45	111
RU 9651-56	111
RU 9651-67	111
RU 9651-78	111
RU 9652-00	111
RU 9652-00/2	111
RU 9652-00/3	111
RU 9652-01	111
RU 9652-12	111
RU 9652-23	111
RU 9652-34	111
RU 9652-45	111
RU 9652-56	111
RU 9652-67	111
RU 9652-78	111
RU 9942-11	88,257
RU 9943-11	88,257
RU 9964-05	88,257
RU-12004-01	127
RU-12004-02	127
RU-12004-05	127
RU-12004-10	127
RU-12131-01	126
RU-12131-02	126
RU-12131-03	126
RU-12131-04	126
RU-12131-05	126
RU-12131-06	126
RU-12131-07	126
RZ 010-000	422
RZ 010-030	421



RUDOLF Medical GmbH + Co. KG
Zollerstr. 1, 78567 Fridingen, Germany
Tel.: +49 7463 9956-0, Fax: +49 7463 9956-56
sales@rudolf-med.com, www.rudolf-med.com



Distributed by:



RUDOLF Medical GmbH + Co. KG
Zollerstr. 1 · 78567 Fridingen, Germany · Phone +49 (74 63) 99 56-0
Fax +49 (74 63) 99 56-56 · sales@rudolf-med.com · www.rudolf-med.com

RUDOLF
BECAUSE WE CARE