



Laparoscopy

Index

Alphabetischer Index, Nummern-Index
Alphabetical Index, Numerical Index
IN1 – IN8

Search



01

Veres-Kanülen
Veres Cannulas
LP1 – LP3



02

Optiken
Optics
LP5 – LP10



03

Trokare und Zubehör
Trocars and Accessories
LP11 – LP29



04

Screw-In Instrumente
Screw-In Instruments
LP31 – LP56



05

Saug- und Spülinstrumente
Suction and Irrigation
LP57 – LP61

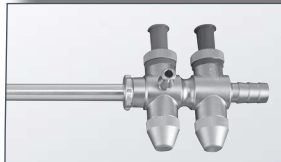

06

HF Monopolar
HF Monopolar
LP63 – LP69



07

HF Bipolar
HF Bipolar
LP71 – LP76



08

Naht- und Clipanlegeinstrumente
Suturing / Clip Applicators
LP77 – LP85

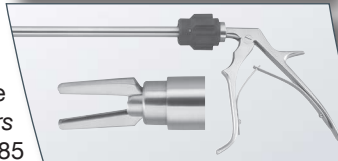

09

Diverse Laparoskopie-Instrumente
Various Laparoscopy Instruments
LP87 – LP93

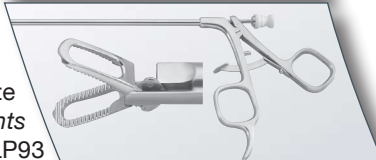

10

Zubehör
Accessories
LP95 – LP100

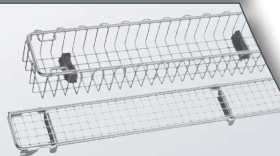

Laparoscopy

ZK 583-02 EN

Gerätekatalog
Devices Catalogue
LP101

RUDOLF



Endoscopy Devices
Endoscopy Devices

Index

Alphabetischer Index, Nummern Index
Alphabetical Index, Numerical Index
IN1 – IN8

Search



01

Veres-Kanülen
Veres Cannulas
LP1 - LP3



02

Optiken
Optics
LP5 - LP10



03

Trokare und Zubehör
Trocars and Accessories
LP11 – LP29



04

Screw-In Instrumente
Screw-In Instruments
LP31 – LP56



05

Saug- und Spülinstrumente
Suction and Irrigation
LP57 – LP61

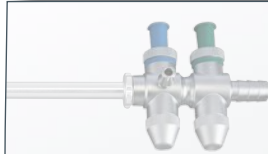

06

HF Monopolar
HF Monopolar
LP63 – LP69



07

HF Bipolar
HF Bipolar
LP71 – LP76



08

Naht- und Clipanlegeinstrumente
Suturing / Clip Appliers
LP77 – LP85

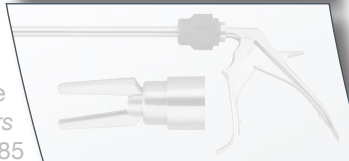

09

Diverse Laparoskopie-Instrumente
Various Laparoscopy Instruments
LP87 – LP93

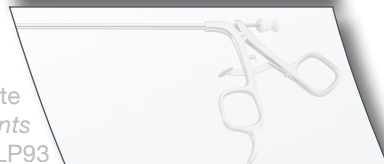

10

Zubehör
Accessories
LP95 – LP100

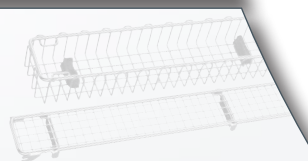

Search



ZK 583-02 EN

Gerätekatalog
Devices Catalogue
LP101

RUDOLF



Endoscopy Devices



CONTENTS ▶ IN1	06 HF MONOPOLAR ▶ LP63
Contents IN3	Electrodes with Suction-Irrigation LP65
Numerical Index..... IN5 – IN8	Electrodes with Suction Channel..... LP66
01 VERES CANNULAS ▶ LP1	Electrodes LP67 - LP68
Veres Cannulas..... LP3	Safety Cables, monopolar LP69
02 OPTICS ▶ LP5	07 HF BIPOLAR ▶ LP71
Optics - Technical Features..... LP7	Standard Forceps System LP73
Laparoscopes LP8	Coagulation Instruments LP74 - LP75
Articulated Arm w. Central Quick-Fixation.... LP9 - LP10	Cables, bipolar LP76
03 TROCARS & ACCESSORIES ▶ LP11	08 SUTURING / CLIP APPLIERS ▶ LP77
Trocars LP13	Suture Assisting Device LP79
Plastic and metal trocars for laparoscopy in sizes	Needle Holder, one-piece..... LP80 - LP81
5, 10 and 12 as well as accessories LP15 - LP28	Needle Holder, three-part..... LP82 - LP83
Rudolf Reducer Systems LP29	Clip-Applying Forceps LP84 - LP85
Reducing Sleeve..... LP29	09 VARIOUS LAPAROSCOPY INSTR. ▶ LP87
04 INSTRUMENTS ▶ LP31	Various Laparoscopy Instruments LP89
RUDOLF SYSTEM Instruments (SCREW-IN)..... LP33	Injection and punction needle..... LP89
Tubes with accessories LP34	Insertion trocar for sterile solution LP89
Handles LP35	Cholangiography Clamp, with Ratchet LP90
Dissecting and Grasping Frceps, divers..... LP36 - LP38	for catheter placement
Dissecting and Grasping Frceps, slim grooved..... LP39	Claw Grasping and Spoon Forceps LP90
Dissecting and Grasping Frceps, grooved w. spoon.. LP40	with Irrigation channel
Dissecting and Grasping Frceps, Maryland..... LP41	Abdominal-Speculum LP91
Dissecting and Grasping Frceps, DeBaKey LP42	Liver Elevators, three-part LP92
Dissecting and Grasping Frceps, with teeth LP43	Liver Elevators, two-part LP93
Dissecting and Grasping Frceps, atraumatic LP44	10 ACCESSORIES ▶ LP95
Dissecting and Grasping Frceps, rippled..... LP45	Cleaning Brushes and Tubing Connectors LP97
Dissecting and Grasping Frceps, fenestrated.. LP46 - LP47	Sterilizing and Storage Accessories..... LP98 - LP99
Biopsy Frceps LP48	Maintenance Products LP100
Scissors, 5 mm LP49 - LP51	11 DEVICE ▶ LP101
Multifunctional LAP Instrument, Piraña Cut..... LP52	Catalogue Endoscopy Devices ZK 583-02 EN
Grasping Forceps, 10 mm..... 72, 74–76	
Dissecting and Grasping Forceps, 10 mm..... LP53 - LP56	
05 SUCTION/IRRIGATION ▶ LP57	
Suction-Irrigation Tube Systems LP59 - LP61	



INHALTSVERZEICHNIS ▶ **IN1**

Inhaltsverzeichnis	IN4
Nummern-Index	IN5 – IN8

01 VERES KANÜLEN ▶ **LP1**

<i>Veres Kanülen</i>	LP3
----------------------------	-----

02 OPTIKEN ▶ **LP5**

Endoskope	LP7
Laparoskope	LP8
Gelenkarm mit zentraler Schnellfixierung	LP9 - LP10

03 TROKARE & ZUBEHÖR ▶ **LP11**

Trokare	LP13
Kunststoff- und Metalltrokare für die Laparoscopia in... den Größen 5, 10 und 12 sowie Zubehör ...	LP15 – LP28
Rudolf Reduzier-Systeme	LP29
Reduzierhülse	LP29

04 SCREW-IN INSTRUMENTE ▶ **LP31**

RUDOLF-SYSTEM-Instrumente (SCREW-IN)	LP33
Rohrschäfte mit Zubehör	LP34
Griffe	LP35
Präparier- Fasszangen, divers	LP36 - LP38
Präparier- Fasszangen, schlank gerieft	LP39
Präparier- Fasszangen, gerieft mit Löffel	LP40
Präparier- Fasszangen, Maryland	LP41
Präparier- Fasszangen, DeBakey	LP42
Präparier- Fasszangen, mit Zähne	LP43
Präparier- Fasszangen, atraumatisch	LP44
Präparier- Fasszangen, gewellt	LP45
Präparier- Fasszangen, gefensterter	LP46 - LP47
Probeexzisionszangen	LP48
Scheren, 5 mm	LP49–LP51
Multifunktionales LAP Instrument, Piraña Cut	LP52
Präparier- und Fasszangen, 10 mm	LP53 - LP56

05 SAUG- UND SPÜLINSTRUMENTE ▶ **LP57**

Saug-Spülrohr-Systeme	LP59 - LP61
-----------------------------	-------------

06 HF MONOPOLAR ▶ **LP63**

Elektroden mit Saug-Spülrohr	LP65
Elektroden mit Saugkanal	LP66
Elektroden	LP67 - LP68
Sicherheitskabel, monopolar	LP69

07 HF BIPOLAR ▶ **LP71**

Standard Zangensystem	LP73
Koagulationsinstrumente	LP74 - LP75
Kabel, bipolar	LP76

08 NAHT- UND CLIPANLEGEINSTR. ▶ **LP77**

Nähhilfen	LP79
Nadelhalter, einteilig	LP80 - LP81
Nadelhalter, dreiteilig	LP82 - LP83
Clip-Anlegezangen	LP84 - LP85

09 DIVERSE LAPAROSKOPIE-INSTR. ▶ **LP87**

Diverse Laparoskopie-Instrumente	LP89
Injektions- und Punktionskanüle	LP89
Einstichtrokar für sterile Lösung	LP89
Cholangiographie-Fixierzange, mit Sperre	LP90 zur Katheterplatzierung
Krallengreifer und Löffelzange	LP90 mit Spülkanal
Abdomina- Spekulum	LP91
Leber-Elevatoren, dreiteilig	LP92
Abwinkelbarer Leber-Elevator, zweiteilig	LP93

10 ZUBEHÖR ▶ **LP95**

Reinigungsbürsten und Schlauchverbinder	LP97
Sterilisations- und Aufbewahrungszubehör ..	LP98-LP99
Pflegeprodukte	LP100

11 GERÄTE ▶ **LP101**

Katalog Endoscopy Devices ZK 583-02 EN



90-0333 LP69	LP305-120..... LP3	LP323-015 LP92	LP372-001 LP84
90-0335 LP69	LP305-150..... LP3	LP323-020 LP92	LP372-002 LP84
EP101.....LP19	LP305-200 LP3	LP323-035 LP93	LP372-010..... LP84
EP101-210.....LP18	LP305-610 LP3	LP323-040 LP93	LP372-020 LP84
EP101-211LP18	LP305-617 LP3	LP323-205 LP91	LP372-100..... LP84
EP103.....LP17	LP310-021 LP59	LP325-010 LP90	LP372-101..... LP84
EP103-230LP16	LP310-031 LP59	LP325-020 LP90	LP440-000 LP73
EP103-231LP16	LP310-032 LP59	LP325-025 LP90	LP440-001 LP73
EP110.....LP21	LP310-200 LP59	LP352-021 LP81	LP440-003 LP73
EP110-200..... LP20	LP310-201..... LP59	LP352-022 LP81	LP440-110 LP73
EP110-201..... LP20	LP310-202..... LP59	LP352-023 LP81	LP440-111 LP73
EP111LP19	LP310-205 LP59	LP353-033 LP81	LP440-113 LP73
EP111-210LP18	LP310-501 LP60	LP353-045 LP81	LP450-000 LP74, LP75
EP111-211LP18	LP310-502 LP60	LP353-133..... LP81	LP450-001 LP74
EP113.....LP17	LP310-503 LP60	LP353-145..... LP81	LP450-002 LP74
EP113-230.....LP16	LP310-510..... LP60	LP353-233 LP81	LP450-003 LP74
EP113-231LP16	LP310-511 LP60	LP353-245 LP81	LP450-004 LP75
EP124-251.....LP15	LP310-512..... LP60	LP353-330 LP81	LP450-005 LP75
EP150-262 LP24	LP310-513..... LP60	LP353-345 LP81	LP450-006 LP75
EP150-266 LP26	LP310-514 LP60	LP354-033 LP81	LP450-110 LP74, LP75
EP150-267 LP28	LP310-515..... LP60	LP354-045 LP81	LP450-111 LP74
EP151-262 LP24	LP310-516 LP60	LP354-133..... LP81	LP450-112 LP74
EP151-266 LP26	LP310-517 LP60	LP354-145..... LP81	LP450-113 LP74
EP151-267 LP28	LP310-518..... LP60	LP354-233 LP81	LP450-114 LP75
EP200LP21	LP312-100 LP61	LP354-245 LP81	LP450-115 LP75
EP201LP21	LP312-105 LP61	LP354-330 LP81	LP450-116 LP75
EP210.....LP19	LP312-110 LP61	LP354-345 LP81	RS000-010..... LP34
EP211LP19	LP312-115 LP61	LP355-000 LP83	RS000-011..... LP34
EP230LP17	LP312-125 LP61	LP355-033 LP83	RS000-012..... LP34
EP231LP17	LP312-130..... LP61	LP355-045 LP83	RS000-013..... LP34
EP400-404 LP15, LP24	LP312-140 LP61	LP355-133..... LP83	RS000-014..... LP34
..... LP26, LP28	LP313-012..... LP89	LP355-145..... LP83	RS000-021..... LP34
EP400-408 LP16, LP17	LP313-013..... LP89	LP355-233 LP83	RS000-022..... LP34
EP400-412 LP18-LP21	LP313-100 LP65	LP355-245 LP83	RS000-023..... LP34
HF300-151 LP69	LP313-111 LP65	LP355-330 LP83	RS000-024..... LP34
HF300-152 LP69	LP313-112 LP65	LP355-345 LP83	RS000-501..... LP38
HF300-153 LP69	LP313-113 LP65	LP356-000 LP83	RS000-502..... LP37
HF310-104..... LP76	LP314-002 LP89	LP356-033 LP83	RS000-503..... LP39
HF310-113 LP76	LP315-111 LP89	LP356-045 LP83	RS000-504..... LP39
HF310-123..... LP76	LP315-112 LP89	LP356-133..... LP83	RS000-505..... LP39
HF310-125 LP76	LP315-113 LP89	LP356-145..... LP83	RS000-506 LP40
HF310-133..... LP76	LP315-501..... LP79	LP356-233 LP83	RS000-507..... LP37
HF310-135..... LP76	LP315-502 LP79	LP356-245 LP83	RS000-508..... LP40
HF310-333 LP76	LP315-510..... LP79	LP356-330 LP83	RS000-509..... LP40
HF310-3031 LP76	LP320-050 LP67	LP356-345 LP83	RS000-515..... LP39
LP000-033..... LP83	LP320-061 LP67	LP357-000 LP83	RS000-516..... LP38
LP000-045 LP83	LP320-062 LP67	LP357-033 LP83	RS000-517..... LP40
LP000-133 LP83	LP320-063 LP67	LP357-045 LP83	RS000-520..... LP37
LP000-145..... LP83	LP320-064 LP67	LP357-133 LP83	RS000-525..... LP41
LP000-233 LP83	LP320-071 LP67	LP357-145 LP83	RS000-526..... LP41
LP000-245 LP83	LP320-072 LP67	LP357-233..... LP83	RS000-527..... LP41
LP000-330 LP83	LP320-073 LP67	LP357-245 LP83	RS000-528..... LP41
LP000-345 LP83	LP320-074 LP67	LP357-330 LP83	RS000-529..... LP42
LP033-000 LP83	LP320-082 LP67	LP357-345 LP83	RS000-530..... LP42
LP045-000 LP83	LP320-111 LP66	LP371-001..... LP85	RS000-531..... LP42
LP100-000 LP8	LP320-112 LP66	LP371-002 LP85	RS000-532..... LP43
LP100-030 LP8	LP320-113 LP66	LP371-003 LP85	RS000-533..... LP43
LP100-045 LP8	LP320-200 LP68	LP371-010..... LP85	RS000-534..... LP43
LP105-000 LP8	LP320-220 LP68	LP371-020..... LP85	RS000-535..... LP38
LP105-030 LP8	LP320-240 LP68	LP371-030 LP85	RS000-536..... LP43
LP105-045 LP8	LP320-250 LP68	LP371-100 LP85	RS000-537..... LP44
LP150-000 LP8	LP320-312 LP66	LP371-101 LP85	RS000-538..... LP44
LP150-030 LP8	LP320-314..... LP66	LP371-210 LP84	RS000-542 LP44
LP250-100..... LP9	LP320-317..... LP66	LP371-211 LP84	RS000-543 LP44
LP250-101..... LP10	LP323-000 LP92	LP371-212 LP84	RS000-546..... LP38
LP250-110 LP9	LP323-002 LP93	LP371-213 LP84	RS000-547..... LP45
LP300-020 LP79	LP323-005 LP92	LP371-214 LP84	RS000-548..... LP45
LP305-100 LP3	LP323-010 LP92	LP371-215 LP84	RS000-549..... LP45



RS000-550.....	LP45	RS000-764.....	LP46	RS115-549.....	LP45	RS117-761.....	LP36
RS000-552.....	LP48	RS000-765.....	LP47	RS115-550.....	LP45	RS117-764.....	LP46
RS000-553.....	LP48	RS000-766.....	LP46	RS115-552.....	LP48	RS117-765.....	LP47
RS000-554.....	LP48	RS000-767.....	LP46	RS115-553.....	LP48	RS117-766.....	LP46
RS000-555.....	LP48	RS000-768.....	LP47	RS115-554.....	LP48	RS117-767.....	LP46
RS000-558.....	LP36	RS000-769.....	LP47	RS115-555.....	LP48	RS117-768.....	LP47
RS000-559.....	LP36	RS000-785.....	LP50	RS115-558.....	LP36	RS117-769.....	LP47
RS000-560.....	LP36	RS000-785CC.....	LP50	RS115-559.....	LP36	RS117-785.....	LP50
RS000-561.....	LP36	RS000-786.....	LP50	RS115-560.....	LP36	RS117-785CC.....	LP50
RS000-564.....	LP46	RS000-790.....	LP51	RS115-561.....	LP36	RS117-786.....	LP50
RS000-565.....	LP47	RS000-790CC.....	LP51	RS115-564.....	LP46	RS117-790.....	LP51
RS000-566.....	LP46	RS000-790TC.....	LP51	RS115-565.....	LP47	RS117-790CC.....	LP51
RS000-567.....	LP46	RS000-790TC/CC.....	LP51	RS115-566.....	LP46	RS117-790TC.....	LP51
RS000-568.....	LP47	RS000-791.....	LP49	RS115-567.....	LP46	RS117-790TC/CC.....	LP51
RS000-569.....	LP47	RS000-791CC.....	LP49	RS115-568.....	LP47	RS117-791.....	LP49
RS000-585.....	LP50	RS000-793.....	LP49	RS115-569.....	LP47	RS117-791CC.....	LP49
RS000-585CC.....	LP50	RS000-795.....	LP52	RS115-585.....	LP50	RS117-793.....	LP49
RS000-586.....	LP50	RS000-901.....	LP53	RS115-585CC.....	LP50	RS117-795.....	LP52
RS000-590.....	LP51	RS000-905.....	LP54	RS115-586.....	LP50	RS119-901.....	LP53
RS000-590CC.....	LP51	RS000-908.....	LP54	RS115-590.....	LP51	RS119-905.....	LP54
RS000-590TC.....	LP51	RS000-912.....	LP53	RS115-590CC.....	LP51	RS119-908.....	LP54
RS000-590TC/CC.....	LP51	RS000-914.....	LP54	RS115-590TC.....	LP51	RS119-912.....	LP53
RS000-591.....	LP49	RS000-918.....	LP56	RS115-590TC/CC.....	LP51	RS119-914.....	LP54
RS000-591CC.....	LP49	RS000-921.....	LP53	RS115-591.....	LP49	RS119-918.....	LP56
RS000-593.....	LP49	RS000-923.....	LP56	RS115-591CC.....	LP49	RS119-921.....	LP53
RS000-595.....	LP52	RS000-930.....	LP55	RS115-593.....	LP49	RS119-923.....	LP56
RS000-701.....	LP38	RS000-932.....	LP55	RS115-595.....	LP52	RS119-930.....	LP55
RS000-702.....	LP37	RS000-934.....	LP54	RS117-701.....	LP38	RS119-932.....	LP55
RS000-703.....	LP39	RS000-941.....	LP55	RS117-702.....	LP37	RS119-934.....	LP54
RS000-704.....	LP39	RS000-943.....	LP56	RS117-703.....	LP39	RS119-941.....	LP55
RS000-705.....	LP39	RS000-948.....	LP53	RS117-704.....	LP39	RS119-943.....	LP56
RS000-706.....	LP40	RS000-954.....	LP55	RS117-705.....	LP39	RS119-948.....	LP53
RS000-707.....	LP37	RS005-000.....	LP34, LP92	RS117-706.....	LP40	RS119-954.....	LP55
RS000-708.....	LP40	RS007-000.....	LP34	RS117-707.....	LP37	RS120-000.....	LP35-LP56
RS000-709.....	LP40	RS009-000.....	LP34, LP92	RS117-708.....	LP40	RS125-501.....	LP38
RS000-715.....	LP39	RS110-000.....	LP35-LP56	RS117-709.....	LP40	RS125-502.....	LP37
RS000-716.....	LP38	RS115-501.....	LP38	RS117-715.....	LP39	RS125-503.....	LP39
RS000-717.....	LP40	RS115-502.....	LP37	RS117-716.....	LP38	RS125-504.....	LP39
RS000-720.....	LP37	RS115-503.....	LP39	RS117-717.....	LP40	RS125-505.....	LP39
RS000-725.....	LP41	RS115-504.....	LP39	RS117-720.....	LP37	RS125-506.....	LP40
RS000-726.....	LP41	RS115-505.....	LP39	RS117-725.....	LP41	RS125-507.....	LP37
RS000-727.....	LP41	RS115-506.....	LP40	RS117-726.....	LP41	RS125-508.....	LP40
RS000-728.....	LP41	RS115-507.....	LP37	RS117-727.....	LP41	RS125-509.....	LP40
RS000-729.....	LP42	RS115-508.....	LP40	RS117-728.....	LP41	RS125-515.....	LP39
RS000-730.....	LP42	RS115-509.....	LP40	RS117-729.....	LP42	RS125-516.....	LP38
RS000-731.....	LP42	RS115-515.....	LP39	RS117-730.....	LP42	RS125-517.....	LP40
RS000-732.....	LP43	RS115-516.....	LP38	RS117-731.....	LP42	RS125-520.....	LP37
RS000-733.....	LP43	RS115-517.....	LP40	RS117-732.....	LP43	RS125-525.....	LP41
RS000-734.....	LP43	RS115-520.....	LP37	RS117-733.....	LP43	RS125-526.....	LP41
RS000-735.....	LP38	RS115-525.....	LP41	RS117-734.....	LP43	RS125-527.....	LP41
RS000-736.....	LP43	RS115-526.....	LP41	RS117-735.....	LP38	RS125-528.....	LP41
RS000-737.....	LP44	RS115-527.....	LP41	RS117-736.....	LP43	RS125-529.....	LP42
RS000-738.....	LP44	RS115-528.....	LP41	RS117-737.....	LP44	RS125-530.....	LP42
RS000-742.....	LP44	RS115-529.....	LP42	RS117-738.....	LP44	RS125-531.....	LP42
RS000-743.....	LP44	RS115-530.....	LP42	RS117-742.....	LP44	RS125-532.....	LP43
RS000-746.....	LP38	RS115-531.....	LP42	RS117-743.....	LP44	RS125-533.....	LP43
RS000-747.....	LP45	RS115-532.....	LP43	RS117-746.....	LP38	RS125-534.....	LP43
RS000-748.....	LP45	RS115-533.....	LP43	RS117-747.....	LP45	RS125-535.....	LP38
RS000-749.....	LP45	RS115-534.....	LP43	RS117-748.....	LP45	RS125-536.....	LP43
RS000-750.....	LP45	RS115-535.....	LP38	RS117-749.....	LP45	RS125-537.....	LP44
RS000-752.....	LP48	RS115-536.....	LP43	RS117-750.....	LP45	RS125-538.....	LP44
RS000-753.....	LP48	RS115-537.....	LP44	RS117-752.....	LP48	RS125-542.....	LP44
RS000-754.....	LP48	RS115-538.....	LP44	RS117-753.....	LP48	RS125-543.....	LP44
RS000-755.....	LP48	RS115-542.....	LP44	RS117-754.....	LP48	RS125-546.....	LP38
RS000-758.....	LP36	RS115-543.....	LP44	RS117-755.....	LP48	RS125-547.....	LP45
RS000-759.....	LP36	RS115-546.....	LP38	RS117-758.....	LP36	RS125-548.....	LP45
RS000-760.....	LP36	RS115-547.....	LP45	RS117-759.....	LP36	RS125-549.....	LP45
RS000-761.....	LP36	RS115-548.....	LP45	RS117-760.....	LP36	RS125-550.....	LP45



RS125-552.....	LP48	RS129-921.....	LP53	RS137-716.....	LP38	RS215-526.....	LP41
RS125-553.....	LP48	RS129-923.....	LP56	RS137-717.....	LP40	RS215-527.....	LP41
RS125-554.....	LP48	RS129-930.....	LP55	RS137-720.....	LP37	RS215-528.....	LP41
RS125-555.....	LP48	RS129-932.....	LP55	RS137-725.....	LP41	RS215-529.....	LP42
RS125-558.....	LP36	RS129-934.....	LP54	RS137-726.....	LP41	RS215-530.....	LP42
RS125-559.....	LP36	RS129-941.....	LP55	RS137-727.....	LP41	RS215-531.....	LP42
RS125-560.....	LP36	RS129-943.....	LP56	RS137-728.....	LP41	RS215-532.....	LP43
RS125-561.....	LP36	RS129-948.....	LP53	RS137-729.....	LP42	RS215-533.....	LP43
RS125-564.....	LP46	RS129-954.....	LP55	RS137-730.....	LP42	RS215-534.....	LP43
RS125-565.....	LP47	RS130-000.....	LP35-LP56	RS137-731.....	LP42	RS215-535.....	LP38
RS125-566.....	LP46	RS135-501.....	LP38	RS137-732.....	LP43	RS215-536.....	LP43
RS125-567.....	LP46	RS135-502.....	LP37	RS137-733.....	LP43	RS215-537.....	LP44
RS125-568.....	LP47	RS135-503.....	LP39	RS137-734.....	LP43	RS215-538.....	LP44
RS125-569.....	LP47	RS135-504.....	LP39	RS137-735.....	LP38	RS215-542.....	LP44
RS127-701.....	LP38	RS135-505.....	LP39	RS137-736.....	LP43	RS215-543.....	LP44
RS127-702.....	LP37	RS135-506.....	LP40	RS137-737.....	LP44	RS215-546.....	LP38
RS127-703.....	LP39	RS135-507.....	LP37	RS137-738.....	LP44	RS215-547.....	LP45
RS127-704.....	LP39	RS135-508.....	LP40	RS137-742.....	LP44	RS215-548.....	LP45
RS127-705.....	LP39	RS135-509.....	LP40	RS137-743.....	LP44	RS215-549.....	LP45
RS127-706.....	LP40	RS135-515.....	LP39	RS137-746.....	LP38	RS215-550.....	LP45
RS127-707.....	LP37	RS135-516.....	LP38	RS137-747.....	LP45	RS215-552.....	LP48
RS127-708.....	LP40	RS135-517.....	LP40	RS137-748.....	LP45	RS215-553.....	LP48
RS127-709.....	LP40	RS135-520.....	LP37	RS137-749.....	LP45	RS215-554.....	LP48
RS127-715.....	LP39	RS135-525.....	LP41	RS137-750.....	LP45	RS215-555.....	LP48
RS127-716.....	LP38	RS135-526.....	LP41	RS137-752.....	LP48	RS215-558.....	LP36
RS127-717.....	LP40	RS135-527.....	LP41	RS137-753.....	LP48	RS215-559.....	LP36
RS127-720.....	LP37	RS135-528.....	LP41	RS137-754.....	LP48	RS215-560.....	LP36
RS127-725.....	LP41	RS135-529.....	LP42	RS137-755.....	LP48	RS215-561.....	LP36
RS127-726.....	LP41	RS135-530.....	LP42	RS137-758.....	LP36	RS215-564.....	LP46
RS127-727.....	LP41	RS135-531.....	LP42	RS137-759.....	LP36	RS215-565.....	LP47
RS127-728.....	LP41	RS135-532.....	LP43	RS137-760.....	LP36	RS215-566.....	LP46
RS127-729.....	LP42	RS135-533.....	LP43	RS137-761.....	LP36	RS215-567.....	LP46
RS127-730.....	LP42	RS135-534.....	LP43	RS137-764.....	LP46	RS215-568.....	LP47
RS127-731.....	LP42	RS135-535.....	LP38	RS137-765.....	LP47	RS215-569.....	LP47
RS127-732.....	LP43	RS135-536.....	LP43	RS137-766.....	LP46	RS217-701.....	LP38
RS127-733.....	LP43	RS135-537.....	LP44	RS137-767.....	LP46	RS217-702.....	LP37
RS127-734.....	LP43	RS135-538.....	LP44	RS137-768.....	LP47	RS217-703.....	LP39
RS127-735.....	LP38	RS135-542.....	LP44	RS137-769.....	LP47	RS217-704.....	LP39
RS127-736.....	LP43	RS135-543.....	LP44	RS139-901.....	LP53	RS217-705.....	LP39
RS127-737.....	LP44	RS135-546.....	LP38	RS139-905.....	LP54	RS217-706.....	LP40
RS127-738.....	LP44	RS135-547.....	LP45	RS139-908.....	LP54	RS217-707.....	LP37
RS127-742.....	LP44	RS135-548.....	LP45	RS139-912.....	LP53	RS217-708.....	LP40
RS127-743.....	LP44	RS135-549.....	LP45	RS139-914.....	LP54	RS217-709.....	LP40
RS127-746.....	LP38	RS135-550.....	LP45	RS139-918.....	LP56	RS217-715.....	LP39
RS127-747.....	LP45	RS135-552.....	LP48	RS139-921.....	LP53	RS217-716.....	LP38
RS127-748.....	LP45	RS135-553.....	LP48	RS139-923.....	LP56	RS217-717.....	LP40
RS127-749.....	LP45	RS135-554.....	LP48	RS139-930.....	LP55	RS217-720.....	LP37
RS127-750.....	LP45	RS135-555.....	LP48	RS139-932.....	LP55	RS217-725.....	LP41
RS127-752.....	LP48	RS135-558.....	LP36	RS139-934.....	LP54	RS217-726.....	LP41
RS127-753.....	LP48	RS135-559.....	LP36	RS139-941.....	LP55	RS217-727.....	LP41
RS127-754.....	LP48	RS135-560.....	LP36	RS139-943.....	LP56	RS217-728.....	LP41
RS127-755.....	LP48	RS135-561.....	LP36	RS139-948.....	LP53	RS217-729.....	LP42
RS127-758.....	LP36	RS135-564.....	LP46	RS139-954.....	LP55	RS217-730.....	LP42
RS127-759.....	LP36	RS135-565.....	LP47	RS210-000.....	LP35-LP56	RS217-731.....	LP42
RS127-760.....	LP36	RS135-566.....	LP46	RS215-501.....	LP38	RS217-732.....	LP43
RS127-761.....	LP36	RS135-567.....	LP46	RS215-502.....	LP37	RS217-733.....	LP43
RS127-764.....	LP46	RS135-568.....	LP47	RS215-503.....	LP39	RS217-734.....	LP43
RS127-765.....	LP47	RS135-569.....	LP47	RS215-504.....	LP39	RS217-735.....	LP38
RS127-766.....	LP46	RS137-701.....	LP38	RS215-505.....	LP39	RS217-736.....	LP43
RS127-767.....	LP46	RS137-702.....	LP37	RS215-506.....	LP40	RS217-737.....	LP44
RS127-768.....	LP47	RS137-703.....	LP39	RS215-507.....	LP37	RS217-738.....	LP44
RS127-769.....	LP47	RS137-704.....	LP39	RS215-508.....	LP40	RS217-742.....	LP44
RS129-901.....	LP53	RS137-705.....	LP39	RS215-509.....	LP40	RS217-743.....	LP44
RS129-905.....	LP54	RS137-706.....	LP40	RS215-515.....	LP39	RS217-746.....	LP38
RS129-908.....	LP54	RS137-707.....	LP37	RS215-516.....	LP38	RS217-747.....	LP45
RS129-912.....	LP53	RS137-708.....	LP40	RS215-517.....	LP40	RS217-748.....	LP45
RS129-914.....	LP54	RS137-709.....	LP40	RS215-520.....	LP37	RS217-749.....	LP45
RS129-918.....	LP56	RS137-715.....	LP39	RS215-525.....	LP41	RS217-750.....	LP45



RS217-752.....LP48	RS225-564.....LP46	RS227-791.....LP49	TR300-125.....LP20,
RS217-753.....LP48	RS225-565.....LP47	RS227-791CC.....LP49LP27-LP28
RS217-754.....LP48	RS225-566.....LP46	RS227-793.....LP49	TR310-055.....LP16,
RS217-755.....LP48	RS225-567.....LP46	RS227-795.....LP52LP23, LP24
RS217-758.....LP36	RS225-568.....LP47	RS229-901.....LP53	TR310-110.....LP18,
RS217-759.....LP36	RS225-569.....LP47	RS229-905.....LP54LP25, LP26
RS217-760.....LP36	RS225-585.....LP50	RS229-908.....LP54	TR310-125.....LP20,
RS217-761.....LP36	RS225-585CC.....LP50	RS229-912.....LP53LP27-LP28
RS217-764.....LP46	RS225-586.....LP50	RS229-914.....LP54	TR330-055.....LP16,
RS217-765.....LP47	RS225-590.....LP51	RS229-918.....LP56LP23, LP24
RS217-766.....LP46	RS225-590CC.....LP51	RS229-921.....LP53	TR330-110.....LP18,
RS217-767.....LP46	RS225-590TC.....LP51	RS229-923.....LP56LP25, LP26
RS217-768.....LP47	RS225-590TC/CC.....LP51	RS229-930.....LP55	TR330-125.....LP20,
RS217-769.....LP47	RS225-591.....LP49	RS229-932.....LP55LP27-LP28
RS219-901.....LP53	RS225-591CC.....LP49	RS229-934.....LP54	TR350-055.....LP16,
RS219-905.....LP54	RS225-593.....LP49	RS229-941.....LP55LP23, LP24
RS219-908.....LP54	RS225-595.....LP52	RS229-943.....LP56	TR350-110.....LP18,
RS219-912.....LP53	RS227-701.....LP38	RS229-948.....LP53LP25, LP26
RS219-914.....LP54	RS227-702.....LP37	RS229-954.....LP55	TR350-125.....LP20,
RS219-918.....LP56	RS227-703.....LP39	RU 5288-31.....LP97LP27-LP28
RS219-921.....LP53	RS227-704.....LP39	RU 8865-51.....LP97	TR405-002.....LP29
RS219-923.....LP56	RS227-705.....LP39	RU 8865-52.....LP97	TR410-002.....LP29
RS219-930.....LP55	RS227-706.....LP40	RU 8865-55.....LP97	TR411-002.....LP29
RS219-932.....LP55	RS227-707.....LP37	RU 8865-56.....LP97	TR420-001.....LP29
RS219-934.....LP54	RS227-708.....LP40	RU 8865-59.....LP97	TR420-003.....LP29
RS219-941.....LP55	RS227-709.....LP40	RU 8865-60.....LP97	TR421-001.....LP29
RS219-943.....LP56	RS227-715.....LP39	RU 8880-05.....LP100	TR422-001.....LP29
RS219-948.....LP53	RS227-716.....LP38	RU 8880-50.....LP100	
RS219-954.....LP55	RS227-717.....LP40	RU 8908-01.....LP99	
RS220-000.....LP35-LP56	RS227-720.....LP37	RU 8908-02.....LP99	
RS225-501.....LP38	RS227-725.....LP41	RU 8908-11.....LP99	
RS225-502.....LP37	RS227-726.....LP41	RU 8908-12.....LP99	
RS225-503.....LP39	RS227-727.....LP41	RU 8908-13.....LP98	
RS225-504.....LP39	RS227-728.....LP41	RU 8908-14.....LP99	
RS225-505.....LP39	RS227-729.....LP42	RU 8908-18.....LP98	
RS225-506.....LP40	RS227-730.....LP42	RU 8930-00.....LP99	
RS225-507.....LP37	RS227-731.....LP42	RU 8930-01.....LP99	
RS225-508.....LP40	RS227-732.....LP43	RZ003-050.....LP15, LP17	
RS225-509.....LP40	RS227-733.....LP43LP23, LP24	
RS225-515.....LP39	RS227-734.....LP43	RZ003-105.....LP19,	
RS225-516.....LP38	RS227-735.....LP38LP25-LP26	
RS225-517.....LP40	RS227-736.....LP43	RZ003-110.....LP19,	
RS225-520.....LP37	RS227-737.....LP44LP25-LP26	
RS225-525.....LP41	RS227-738.....LP44	RZ003-125.....LP21,	
RS225-526.....LP41	RS227-742.....LP44LP27-LP28	
RS225-527.....LP41	RS227-743.....LP44	RZ003-255.....LP15, LP17,	
RS225-528.....LP41	RS227-746.....LP38LP23, LP24	
RS225-529.....LP42	RS227-747.....LP45	RZ003-311.....LP19,	
RS225-530.....LP42	RS227-748.....LP45LP25-LP26	
RS225-531.....LP42	RS227-749.....LP45	RZ003-312.....LP21,	
RS225-532.....LP43	RS227-750.....LP45LP27-LP28	
RS225-533.....LP43	RS227-758.....LP36	RZ005-055.....LP23	
RS225-534.....LP43	RS227-759.....LP36	RZ005-100.....LP25	
RS225-535.....LP38	RS227-760.....LP36	RZ005-125.....LP27	
RS225-536.....LP43	RS227-761.....LP36	RZ006-055.....LP23	
RS225-537.....LP44	RS227-764.....LP46	RZ006-100.....LP25	
RS225-538.....LP44	RS227-765.....LP47	RZ006-125.....LP27	
RS225-542.....LP44	RS227-766.....LP46	RZ010-000.....LP98	
RS225-543.....LP44	RS227-767.....LP46	TR240-055.....LP23	
RS225-546.....LP38	RS227-768.....LP47	TR240-110.....LP25	
RS225-547.....LP45	RS227-769.....LP47	TR240-125.....LP27	
RS225-548.....LP45	RS227-785.....LP50	TR240-255.....LP23	
RS225-549.....LP45	RS227-785CC.....LP50	TR240-311.....LP25	
RS225-550.....LP45	RS227-786.....LP50	TR240-325.....LP27	
RS225-558.....LP36	RS227-790.....LP51	TR300-055.....LP16,	
RS225-559.....LP36	RS227-790CC.....LP51LP23, LP24	
RS225-560.....LP36	RS227-790TC.....LP51	TR300-110.....LP18,	
RS225-561.....LP36	RS227-790TC/CC.....LP51LP25, LP26	

Index

Alphabetischer Index, Nummern Index
Alphabetical Index, Numerical Index
IN1 – IN8

Search



01

Veres-Kanülen
Veres Cannulas
LP1 - LP3

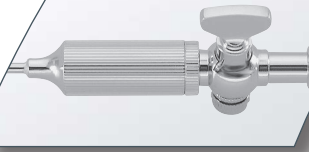

02

Optiken
Optics
LP5 - LP10



03

Trokare und Zubehör
Trocars and Accessories
LP11 – LP29



04

Screw-In Instrumente
Screw-In Instruments
LP31 – LP56



05

Saug- und Spülinstrumente
Suction and Irrigation
LP57 – LP61

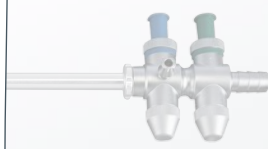

06

HF Monopolar
HF Monopolar
LP63 – LP69

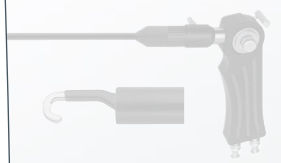

07

HF Bipolar
HF Bipolar
LP71 – LP76



08

Naht- und Clipanlegeinstrumente
Suturing / Clip Appliers
LP77 – LP85

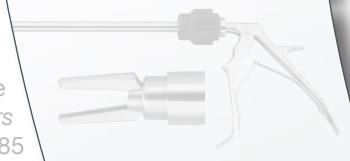

09

Diverse Laparoskopie-Instrumente
Various Laparoscopy Instruments
LP87 – LP93



10

Zubehör
Accessories
LP95 – LP100

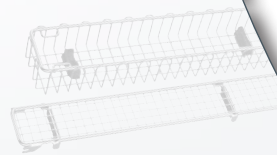

ZK 583-02 EN

Gerätekatalog
Devices Catalogue
LP101



RUDOLF





Endoscopy Devices
Endoscopy Devices



Insufflationsnadel nach Veres, Ø 2 mm
Insufflation needle, Veres, Ø 2 mm

Bestell-Nr. Ordering no.	Nutzlänge Working length	
LP305-100	100 mm	
LP305-120	120 mm	
LP305-150	150 mm	
LP305-200	200 mm	

High Flow Veres-Kanüle, Ø 2,7 mm
High flow Veres cannula, Ø 2.7 mm

Bestell-Nr. Ordering no.	Nutzlänge Working length	
LP305-610	100 mm	
LP305-617	170 mm	



Index

Alphabetischer Index, Nummern Index
Alphabetical Index, Numerical Index
IN1 – IN8

Search



01

Veres-Kanülen
Veres Cannulas
LP1 - LP3



02

Optiken
Optics
LP5 - LP10



03

Trokare und Zubehör
Trocars and Accessories
LP11 - LP29



04

Screw-In Instrumente
Screw-In Instruments
LP31 - LP56



05

Saug- und Spülinstrumente
Suction and Irrigation
LP57 - LP61

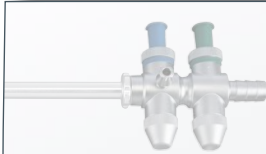

06

HF Monopolar
HF Monopolar
LP63 - LP69

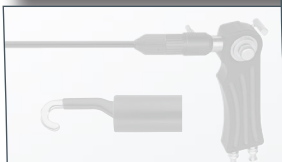

07

HF Bipolar
HF Bipolar
LP71 - LP76



08

Naht- und Clipanlegeinstrumente
Suturing / Clip Applicators
LP77 - LP85

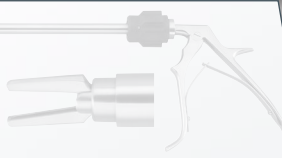

09

Diverse Laparoskopie-Instrumente
Various Laparoscopy Instruments
LP87 - LP93

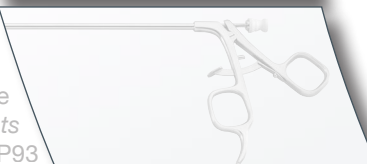

10

Zubehör
Accessories
LP95 - LP100

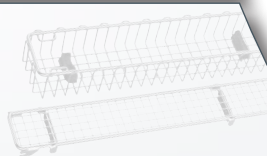

ZK 583-02 EN

Gerätekatalog
Devices Catalogue
LP101

RUDOLF



Endoscopy Devices
Endoscopy Division

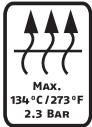

Alle RUDOLF Medical Optiken werden nach höchsten Anforderungen an Präzision und Genauigkeit entwickelt.

All RUDOLF Medical optics are developed according to the highest demands on precision and accuracy.

Optiken - Technische Merkmale

Optics - Technical Features

Alle RUDOLF Medical Optiken erfüllen die Anforderungen für die HD-Endoskopie.

All RUDOLF Medical optics meet the requirements for HD (High Definition) endoscopy.

- Stabliniensysteme auf dem neuesten Stand der Technik
- Ausschließliche Verwendung von optischen Bauteile höchster Qualität
- Neueste Generation von Lichtfasern für beste Lichttransmission und Bildausleuchtung
- Beste Tiefenschärfe bei maximaler Helligkeit, exzellentem Kontrast und brillanter Detailtreue
- Optische Systeme optimiert für die Anforderungen der jeweiligen Operationstechnik
- Höchste Lebensdauer durch Anwendung neuester Fertigungstechnologien wie Laserschweißen und Goldverlöten zur hermetischen Abdichtung des kratzfesten Saphirglases am proximalen und distalen Ende der Optik
- RUDOLF Medical Optiken erfüllen alle Anforderungen an moderne Aufbereitungsverfahren* und sind freigegeben für:
 - Autoklavieren (Dampfsterilisation)
 - Desinfektion in Flüssigkeiten
 - Steris®
 - Sterrad®

- *State-of-the-art rod lens systems*
- *Use of first-class optical components only*
- *Latest generation of illumination fibers for best light transmission and highest illumination level*
- *Optimal depth of field at maximum luminosity, excellent contrast and brilliant detail rendition*
- *Optical systems optimized for the requirements of the specific application*
- *Long service life thanks to state-of-the-art manufacturing technologies such as laser welding and gold soldering for the hermetic sealing of the scratch resistant sapphire glass at the proximal and distal ends of the optics*
- *RUDOLF Medical optics meet all requirements of modern reprocessing procedures* and are approved for:*
 - *Autoclaving (steam sterilisation)*
 - *Disinfection liquids*
 - *Steris®*
 - *Sterrad®*

Wir gewähren auf alle RUDOLF Medical Optiken **3 Jahre Garantie!**

*We grant a **3-year warranty** on all RUDOLF Medical optics!*

*Die Aufbereitungshinweise sind zu beachten.

**Please follow the reprocessing instructions.*

Laparoskope Laparoscopes



Mitgelieferte Adapter für Anschlussstandards
Adapters included for connection standards

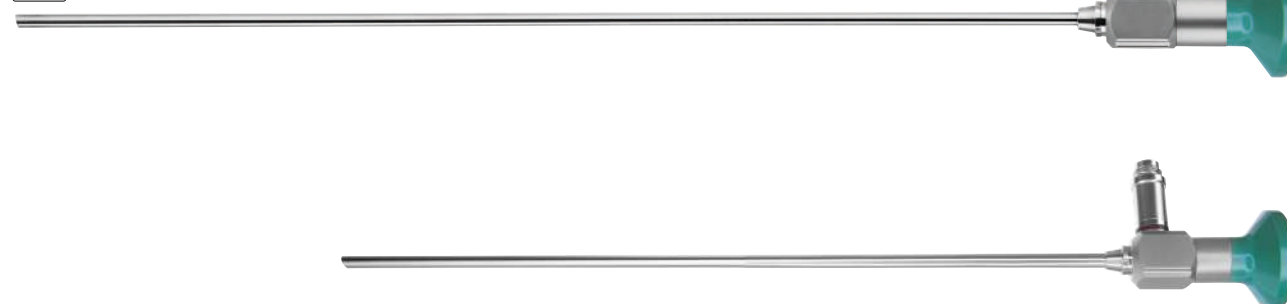
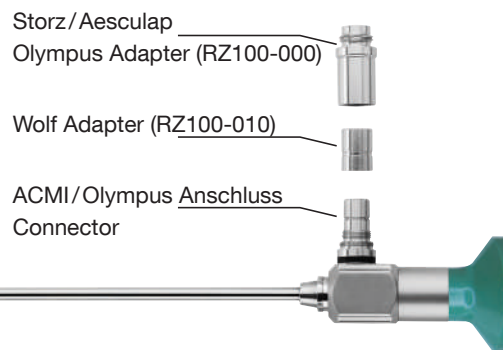

5

Bestell-Nr. Ordering no.	Durchmesser Diameter	Blickrichtung Direction of view	Nutzlänge Working length	Kennfarbe Colour code
LP150-000	5 mm	0°	300 mm	grün – green
LP150-030	5 mm	30°	300 mm	rot – red

10



Bestell-Nr. Ordering no.	Durchmesser Diameter	Blickrichtung Direction of view	Nutzlänge Working length	Kennfarbe Colour code
LP100-000	10 mm	0°	340 mm	grün – green
LP100-030	10 mm	30°	340 mm	rot – red
LP100-045	10 mm	45°	340 mm	schwarz – black

10



Bestell-Nr. Ordering no.	Durchmesser Diameter	Blickrichtung Direction of view	Nutzlänge Working length	Kennfarbe Colour code
LP105-000	10 mm	0°	425 mm	grün – green
LP105-030	10 mm	30°	425 mm	rot – red
LP105-045	10 mm	45°	425 mm	schwarz – black

Gelenkarm mit zentraler Schnellfixierung Articulated Arm with Central Quick-Fixation





Optik-Halterung

Halterungen für die Fixierung und stabile Positionierung der Optik erhältlich aus sterilisierbarem Kunststoff und mit verschiedenen Durchmessern. Die seitliche Öffnung ermöglicht ein einfaches Einführen der Optik.

Optics Holding Device

Holders for the fixation and firm positioning of the optics available in sterilizable medical-grade plastic and in various diameters. The opening at the side facilitates the insertion of the endoscope.

Bestell-Nr. Ordering no.	Lieferumfang Delivery includes	Endoskop-Halterung Endoscope holder
LP250-100	<ul style="list-style-type: none"> • Optikhalter Ø 5 / 10 mm • Gelenkarm, Aktionsradius 400 mm • Säule 300 mm, Höhe verstellbar • Schienensockel, 2-fache Klemmung <p>Für minimalinvasive Chirurgie (MIC), Allgemeinchirurgie und Neurochirurgie.</p> <ul style="list-style-type: none"> • Endoscope holder, Ø 5 / 10 mm, • Articulated arm, 400 mm action radius • Column 300 mm, height-adjustable • Rail clamping base, double clamping <p>For Minimally Invasive Surgery (MIS), General Surgery and Neurosurgery.</p>	<p>Standard Standard</p> 
LP250-110	<ul style="list-style-type: none"> • Optikhalter Ø 5 / 10 mm • Gelenkarm, Aktionsradius 400 mm • L-Säule 450 x 100 mm, Höhe verstellbar • Schienensockel, 2-fache Klemmung <p>Für minimalinvasive Chirurgie (MIC), Allgemeinchirurgie und Neurochirurgie. Durch die L-Säule sind vielseitige Positionierungen möglich.</p> <ul style="list-style-type: none"> • Endoscope holder, Ø 5 / 10 mm, • Articulated arm, 400 mm action radius • L-column 450 x 100 mm, height-adjustable • Rail clamping base, double clamping <p>For Minimally Invasive Surgery (MIS), General Surgery and Neurosurgery.</p> <p>The L column allows many different configurations.</p>	<p>L-Säule L-column</p> 

Gelenkarm mit zentraler Schnellfixierung Articulated Arm with Central Quick-Fixation

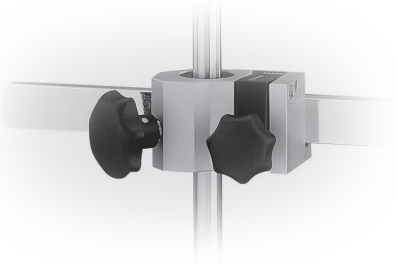

Bestell-Nr. Ordering no.	Vorteile Advantages	Isolierter Schienensockel Isolated rail clamping base
LP250-101	<ul style="list-style-type: none">• Empfohlen für HF-Anwendungen• Kompakt, stabil• Bedienung von vorne• Einfache, feste Klemmung• Robuste Materialien, geprüft• Dampfsterilisierbar bei 134 °C / 273 °F• Spannungsfestigkeit 1500V/AC <ul style="list-style-type: none">• <i>Recommended for HF surgery</i>• <i>Compact and very stable</i>• <i>Operation from the front</i>• <i>Simple and solid clamping system</i>• <i>Robust medical-grade materials, tested</i>• <i>Steam-sterilizable at 134°C / 273 °F</i>• <i>Voltage resistance 1500 V / AC</i>	

Index

Alphabetischer Index, Nummern Index
Alphabetical Index, Numerical Index
IN1 – IN8

Search



01

Veres-Kanülen
Veres Cannulas
LP1 - LP3



02

Optiken
Optics
LP5 - LP10



03

Trokare und Zubehör
Trocars and Accessories
LP11–LP29



04

Screw-In Instrumente
Screw-In Instruments
LP31–LP56



05

Saug- und Spülinstrumente
Suction and Irrigation
LP57–LP61

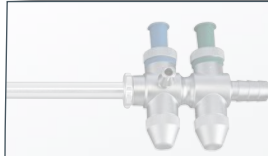

06

HF Monopolar
HF Monopolar
LP63–LP69

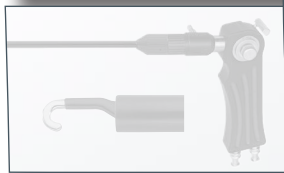

07

HF Bipolar
HF Bipolar
LP71–LP76



08

Naht- und Clipanlegeinstrumente
Suturing / Clip Appliers
LP77–LP85

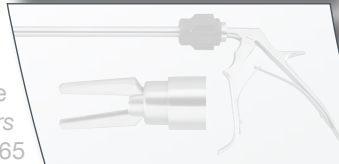

09

Diverse Laparoskopie-Instrumente
Various Laparoscopy Instruments
LP87–LP93

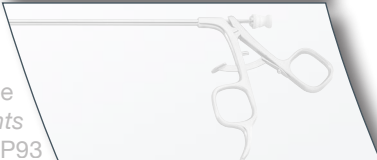

10

Zubehör
Accessories
LP95–LP100

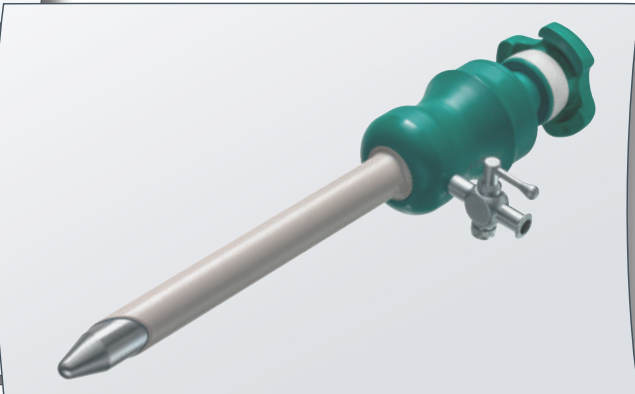
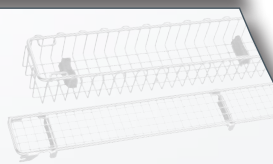

ZK 583-02 EN

Gerätekatalog
Devices Catalogue
LP101

RUDOLF



Endoscopy Devices
Endoscopy Division

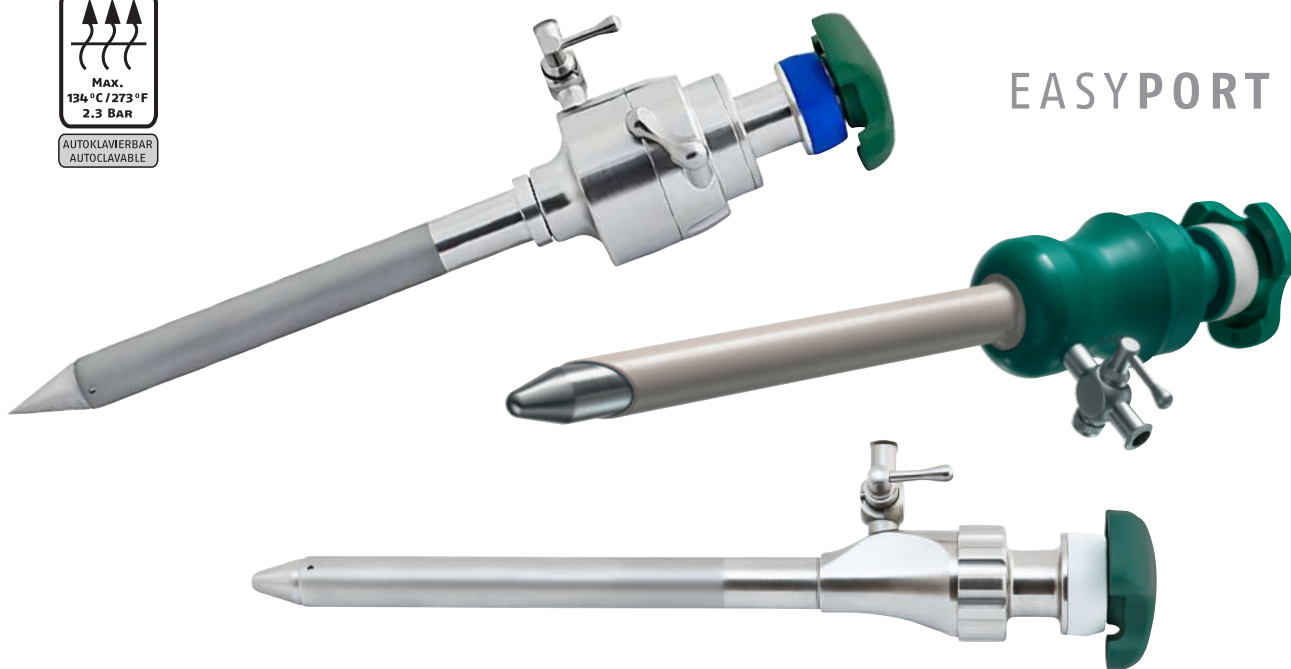

EASYPORT

RUDOLF Medical bietet ein umfangreiches Sortiment an verschiedenen Trokare und Trokardornen für die Laparoskopie.

Neben den klassischen Metalltrokaren aus rostfreiem Edelstahl verfügen wir zusätzlich über eine Serie von Kunststofftrokaren aus leichten, Hochleistungskunststoffen (PEEK / PPSU). Die **EASYPORT** Trokarfamilie kann ebenfalls bei 134°C autoklaviert werden und vereint somit die Vorteile der Wiederverwendbarkeit mit einer ergonomischen Leichtbauweise.

Alle Trokarmodelle sind in drei Größen erhältlich, passend für LAP-Instrumente mit den Durchmessern 5, 10 oder 12 mm, die Standardlänge ist 100 mm.

Je nach Kundenwunsch sind die Trokare mit oder ohne Hahn für die CO₂ Insufflation verfügbar und als Ausführung mit glattem Rohr oder mit Gewinde erhältlich.

Ein breites Sortiment an hochwertigen Trokardornen mit unterschiedlichen Geometrien, sowie einem Sicherheitstrokardorn, runden das RUDOLF-Trokarer Sortiment ab. Außerdem finden Sie auf den folgenden Seiten Zubehör und Ersatzteile für die RUDOLF Trokare.

RUDOLF Medical offers a wide range of different trocars and trocar spikes for laparoscopy.

*In addition to our classic metal trocars made of stainless steel, we also have a series of plastic trocars made of lightweight, high-performance plastics (PEEK / PPSU). The **EASYPORT** trocar family can be autoclaved at 134°C and thus combines the advantages of reusability with an ergonomic lightweight design.*

All trocar models are available in three sizes, suitable for LAP instruments with diameters of 5-, 10- or 12-mm, the standard length is 100 mm.

Depending on the customer's requirements, the trocars are available with or without stopcock for CO₂ insufflation and as a plain tube or threaded version.

A wide range of high-quality trocar spikes with different geometries, as well as a safety trocar spike, complete the RUDOLF trocar range. You will also find accessories and spare parts for the RUDOLF trocars on the following pages.

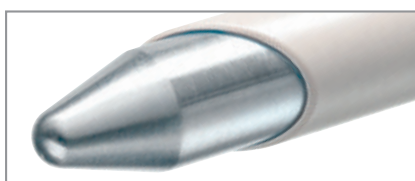





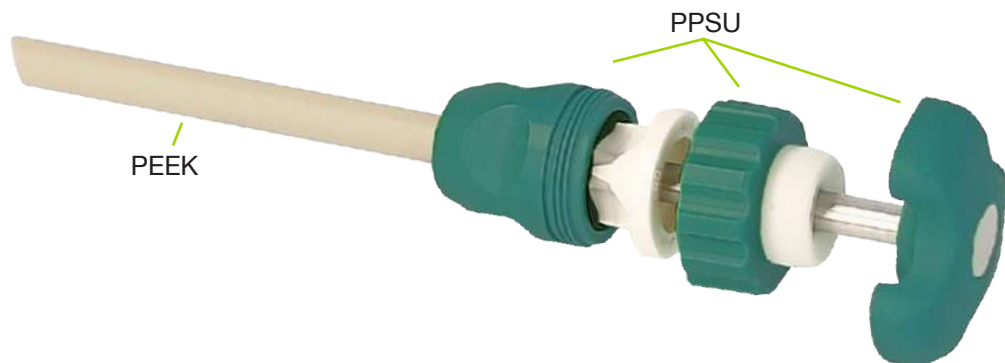

EASYPORT Trokare, für Instrumente mit Ø 5 mm
 EASYPORT Trocars, for instruments with Ø 5 mm



Trokar, mit Dorn
 Trocar, with spike

Bestell-Nr. Ordering no.	Bezeichnung Description	
*EP124-251	Trokar mit Trokardorn/Dreikantschliff, Nutzlänge 70 mm Trocar with trocar spike/triangular cut, working length 70 mm	
EP400-404	Passendes Silikonventil, 5 Stk./Pack (Einweg) Suitable silicone valve, 5 pcs./pack (disposable)	
RZ003-255	Universal-Dichtungskappen, grau, VE 10Stk. Universal sealing caps, grey, PU 10 pcs.	
RZ003-050	Universal-Dichtungskappen, rot, VE 10Stk. Universal sealing caps, red, PU 10 pcs.	

*nicht als Einzelteile erhältlich!
 *not available as spare parts!

EASYPORT Trokare, für Instrumente mit Ø 5 mm

EASYPORT Trocars, for instruments with Ø 5 mm



Trokare, ohne Dorn
Trocars, without spike

Bestell-Nr. Ordering no.	Bezeichnung Description	Nutzlänge Working length	
EP103-230	Trokar, Rohr glatt, mit Absperrhahn Trocar, tube plain, with stopcock	100 mm	
EP103-231	Trokar, Rohr glatt, ohne Absperrhahn Trocar, tube plain, without stopcock	100 mm	
EP113-230	Trokar, Rohr mit Gewinde, mit Absperrhahn Trocar, tube threaded, with stopcock	100 mm	
EP113-231	Trokar, Rohr mit Gewinde, ohne Absperrhahn Trocar, tube threaded, without stopcock	100 mm	
EP400-408	Passendes Silikonventil, 5 Stk./Pack (Einweg) Suitable silicone valve, 5 pcs./pack (disposable)		

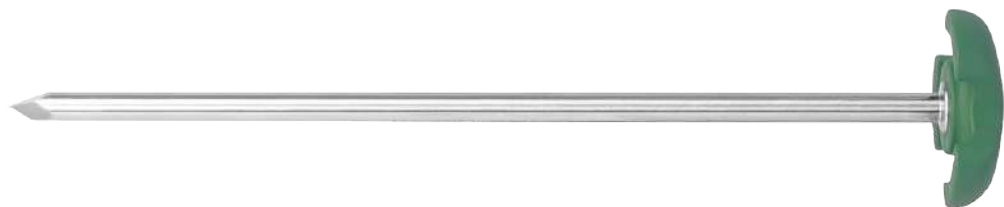





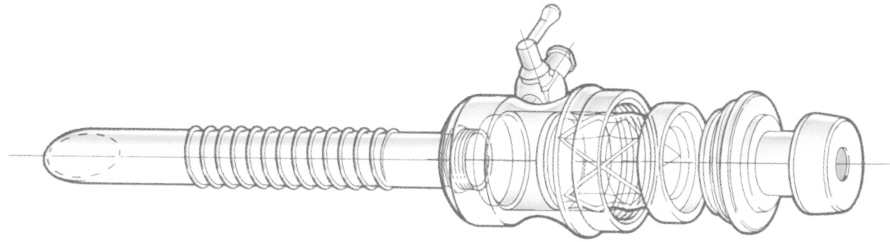

Passende Trokardorne
Suitable trocar spike

Bestell-Nr. Ordering no.	Bezeichnung Description		
TR350-055	Sicherheitstrokardorn Safety trocar spike		
TR300-055	Trokardorn, konisch Trocar spike, conical point		
TR310-055	Trokardorn mit Dreikantschliff Trocar spike with triangular cut		
TR330-055	Trokardorn, kegelförmig stumpf Trocar spike, conical blunt		

Trokardorne und Hülsen frei kombinierbar
Trocar spikes and sleeves free combinable



Bestell-Nr. Ordering no.	Bezeichnung Description	
EP230	Trokarkörper mit Absperrhahn Trocar body with stopcock	
EP231	Trokarkörper ohne Absperrhahn Trocar body without stopcock	
EP103	Trokarrohr glatt, NL 100 mm Trocar tube plain, WL 100 mm	
EP113	Trokarrohr mit Gewinde, NL 100 mm Trocar tube threaded, WL 100 mm	
EP400-408	Passendes Silikonventil, 5 Stk./Pack (Einweg) Suitable silicone valve, 5 pcs./pack (disposable)	
RZ003-255	Universal-Dichtungskappen, grau, VE 10 Stk. Universal sealing caps, grey, PU 10 pcs	
RZ003-050	Universal-Dichtungskappen, rot, VE 10 Stk. Universal sealing caps, red, PU 10 pcs	

EASYPORT Trokare, für Instrumente mit Ø 10 mm

EASYPORT Trocars, for instruments with Ø 10 mm



10

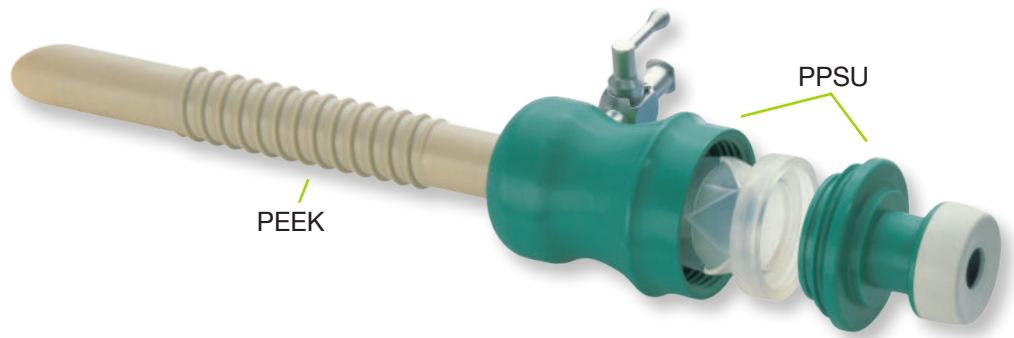

Trokare, ohne Dorn
Trocars, without spike

Bestell-Nr. Ordering no.	Bezeichnung Description	Nutzlänge Working length	
EP101-210	Trokar, Rohr glatt, mit Absperrhahn Trocar, tube plain, with stopcock	100 mm	
EP101-211	Trokar, Rohr glatt, ohne Absperrhahn Trocar, tube plain, without stopcock	100 mm	
EP111-210	Trokar, Rohr mit Gewinde, mit Absperrhahn Trocar tube, threaded, with stopcock	100 mm	
EP111-211	Trokar, Rohr mit Gewinde, ohne Absperrhahn Trocar tube, threaded, without stopcock	100 mm	
EP400-412	Passendes Silikonventil, 5 Stk./Pack (Einweg) Suitable silicone valve, 5 pcs./pack (disposable)		









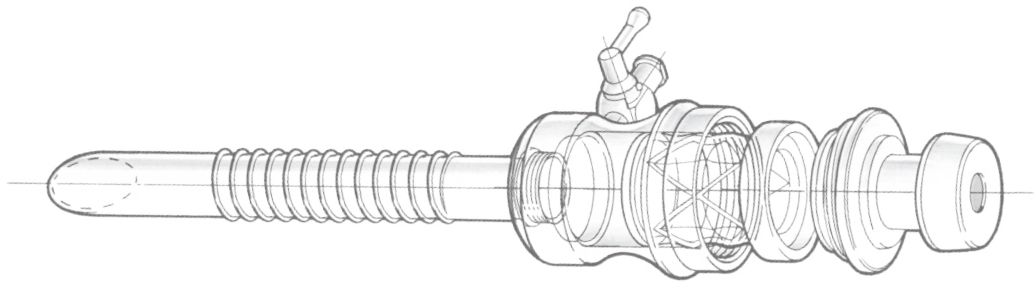

Passende Trokardorne
Suitable trocar spike

Bestell-Nr. Ordering no.	Bezeichnung Description		
TR350-110	Sicherheitstrokardorn Safety trocar spike		
TR300-110	Trokardorn, konisch Trocar spike, conical point		
TR310-110	Trokardorn mit Dreikantschliff Trocar spike with triangular cut		
TR330-110	Trokardorn für Hasson, kegelförmig stumpf Trocar spike for Hasson, conical blunt		

Trokardorne und Hülsen frei kombinierbar
Trocar spikes and sleeves free combinable

10



Bestell-Nr. Ordering no.	Bezeichnung Description	
EP210	Trokarkörper mit Absperrhahn Trocar body with stopcock	
EP211	Trokarkörper ohne Absperrhahn Trocar body without stopcock	
EP101	Trokarrohr glatt, NL 100 mm Trocar tube plain, WL 100 mm	
EP111	Trokarrohr mit Gewinde, NL 100 mm Trocar tube threaded, WL 100 mm	
EP400-412	Passendes Silikonventil, 5 Stk./Pack (Einweg) Suitable silicone valve, 5 pcs./pack (disposable)	
RZ003-311	Universal-Dichtungskappen, grau, VE 10 Stk. Universal sealing caps, grey, PU 10 pcs	
RZ003-105	Universal-Dichtungskappen, blau, VE 10 Stk. Universal sealing caps, blue, PU 10 pcs	
RZ003-110	Universal-Dichtungskappen, rot, VE 10 Stk. Universal sealing caps, red, PU 10 pcs	

EASYPORT Trokare, für Instrumente mit Ø 12 mm EASYPORT Trocars, for instruments with Ø 12 mm



12

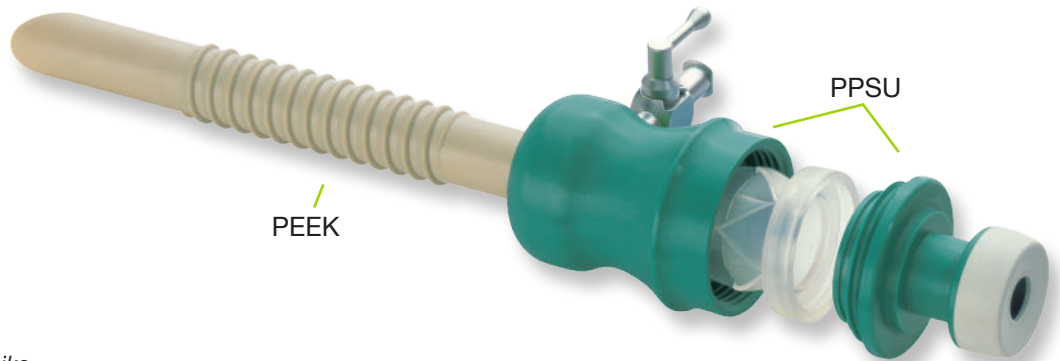

Trokare, ohne Dorn
Trocars, without spike

Bestell-Nr. Ordering no.	Bezeichnung Description	Nutzlänge Working length	
EP110-200	Trokar, Rohr mit Gewinde, mit Absperrhahn Trocar, tube threaded, with stopcock	100 mm	
EP110-201	Trokar, Rohr ohne Gewinde, ohne Absperrhahn Trocar tube, threaded, without stopcock	100 mm	
EP400-412	Passendes Silikonventil, 5 Stk./Pack (Einweg) Suitable silicone valve, 5 pcs./pack (disposable)		



Passende Trokardorne
Suitable trocar spike





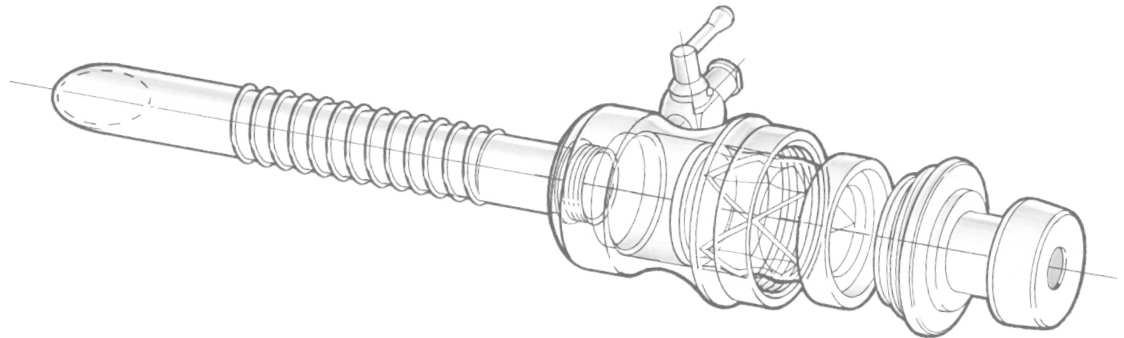

Bestell-Nr. Ordering no.	Bezeichnung Description		
TR350-125	Sicherheitstrokardorn Safety trocar spike		
TR300-125	Trokardorn, konisch Trocar spike, conical point		
TR310-125	Trokardorn mit Dreikantschliff Trocar spike with triangular cut		
TR330-125	Trokardorn für Hasson, kegelförmig stumpf Trocar spike for Hasson, conical blunt		

Trokardorne und Hülsen frei kombinierbar
Trocar spikes and sleeves free combinable



12



Bestell-Nr. Ordering no.	Bezeichnung Description	
EP200	Trokarkörper mit Absperrhahn Trocar body with stopcock	
EP201	Trokarkörper ohne Absperrhahn Trocar body without stopcock	
EP110	Trokarrohr mit Gewinde, NL 100 mm Trocar tube threaded, WL 100 mm	
EP400-412	Passendes Silikonventil, VE 5 Stk. (Einweg) Suitable silicone valve, PU 5 pcs (disposable)	
RZ003-312	Universal-Dichtungskappen, grau, VE 10 Stk. Universal sealing caps, grey, PU 10 pcs	
RZ003-125	Universal-Dichtungskappen, grün, VE 10 Stk. Universal sealing caps, green, PU 10 pcs	



Trokare aus Metall, für Instrumente mit Ø 5 mm

Trocars made of metal, for instruments with Ø 5 mm

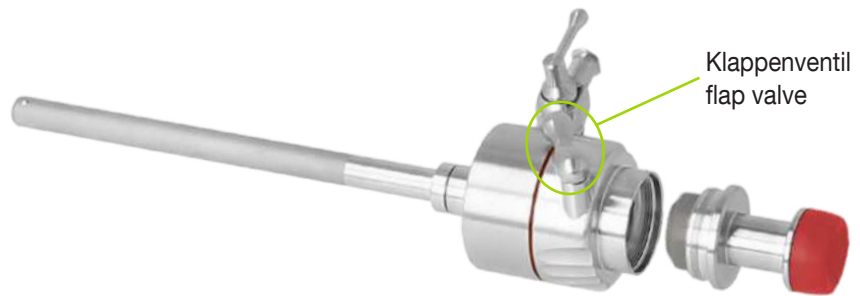

Trokar, ohne Dorn
Trocar, without spike

Bestell-Nr. Ordering no.	Bezeichnung Description	Nutzlänge Working length	
TR240-055	Trokar, Rohr glatt, mit Absperrhahn Trocar, tube plain, with stopcock	95 mm	
TR240-255	Trokarrohr mit Gewinde (Metall) Trocar tube threaded (metal)		
RZ003-255 RZ003-050	Universal-Dichtungskappen, grau, rot, VE 10 Stk. Universal sealing caps, grey, red, PU 10 pcs		
RZ005-055	Dichtungsring, grau, VE 10 Stk. Sealing ring, grey, PU 10 pcs		
RZ006-055	Dichtungsring Gehäuse, 25 x 1.5 m, VE 10 Stk. Sealing ring housing, 25 x 1.5 mm, PU 10 pcs		



Passende Trokardorne
Suitable trocar spike

Bestell-Nr. Ordering no.	Bezeichnung Description		
TR350-055	Sicherheitstrokardorn Safety trocar spike		
TR300-055	Trokardorn, konisch Trocar spike, conical point		
TR310-055	Trokardorn mit Dreikantschliff Trocar spike with triangular cut		
TR330-055	Trokardorn, kegelförmig stumpf Trocar spike, conical blunt		

Trokardorne und Hülsen frei kombinierbar
Trocar spikes and sleeves free combinable

Trokare aus Metall, für Instrumente mit Ø 5 mm Trocars made of metal, for instruments with Ø 5 mm



Trokare, ohne Dorn
Trocars, without spike

Bestell-Nr. Ordering no.	Bezeichnung Description	Nutzlänge Working length	
EP150-262	Trokar, Rohr glatt, mit Absperrhahn Trocar, tube plain, with stopcock	100 mm	
EP151-262	Trokar, Rohr mit Gewinde, mit Absperrhahn Trocar, tube threaded, with stopcock	100 mm	
EP400-404	Passendes Silikonventil, VE 5 Stk. (Einweg) Suitable silicone valve, PU 5 pcs (disposable)		
RZ003-255 RZ003-050	Universal-Dichtungskappen, grau, rot, VE 10 Stk. Universal sealing caps, grey, red, PU 10 pcs		



Passende Trokardorne
Suitable trocar spikes

Bestell-Nr. Ordering no.	Bezeichnung Description		
TR350-055	Sicherheitstrokardorn Safety trocar spike		
TR300-055	Trokardorn, konisch Trocar spike, conical point		
TR310-055	Trokardorn mit Dreikantschliff Trocar spike with triangular cut		
TR330-055	Trokardorn, kegelförmig stumpf Trocar spike, conical blunt		

Trokardorne und Hülsen frei kombinierbar
Trocar spikes and sleeves free combinable

Trokare aus Metall, für Instrumente mit Ø10mm

Trocars made of metal, for instruments with Ø10mm



10

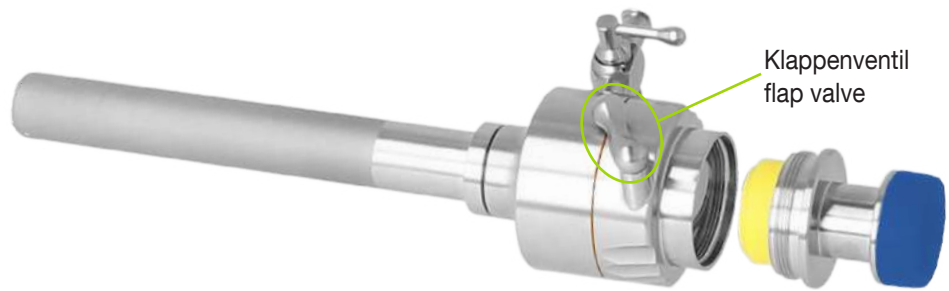

Trokar, ohne Dorn
Trocar, without spike

Bestell-Nr. Ordering no.	Bezeichnung Description	Nutzlänge Working length	
TR240-110	Trokar, Rohr glatt, mit Absperrhahn Trocar, tube plain, with stopcock	101 mm	
TR240-311	Trokarrohr mit Gewinde (Metall) Trocar tube threaded (metal)		
RZ003-311 RZ003-105 RZ003-110	Universal-Dichtungskappen, grau, blau oder rot, VE 10 Stk. Universal sealing caps, grey, blue or red, PU 10 pcs		
RZ005-100	Dichtungsring, gelb, VE 10 Stk. Sealing ring, yellow, PU 10 pcs		
RZ006-100	Dichtungsring für Gehäuse, 30 x 1.5 mm, VE 10 Stk. Sealing ring for housing, 30 x 1.5 mm, PU 10 pcs		



Passende Trokardorne
Suitable trocar spikes

Bestell-Nr. Ordering no.	Bezeichnung Description		
TR350-110	Sicherheitstrokardorn Safety trocar spike		
TR300-110	Trokardorn, konisch Trocar spike, conical point		
TR310-110	Trokardorn mit Dreikantschliff Trocar spike with triangular cut		
TR330-110	Trokardorn für Hasson, kegelförmig stumpf Trocar spike for Hasson, conical blunt		

Trokardorne und Hülsen frei kombinierbar
Trocar spikes and sleeves free combinable

Trokare aus Metall, für Instrumente mit Ø 10 mm

Trocars made of metal, for instruments with Ø 10 mm

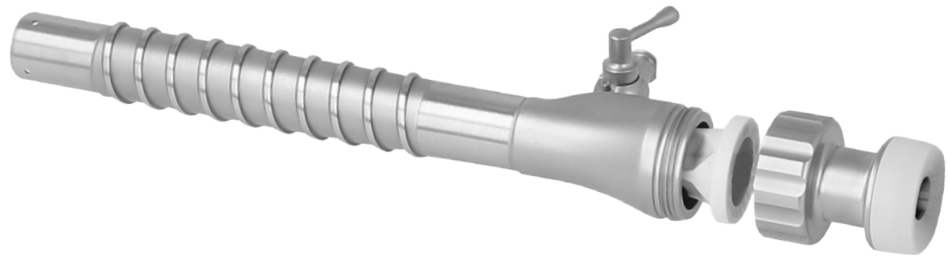

Trokare, ohne Dorn
Trocars, without spike

Bestell-Nr. Ordering no.	Bezeichnung Description	Nutzlänge Working length	
EP150-266	Trokar, Rohr glatt, mit Absperrhahn Trocar, tube plain, with stopcock	111 mm	
EP151-266	Trokar, Rohr mit Gewinde, mit Absperrhahn Trocar, tube threaded, with stopcock	111 mm	
EP400-404	Passendes Silikonventil, VE 10 Stk. (Einweg) Suitable silicone valve, PU 5 pcs (disposable)		
RZ003-311 RZ003-105 RZ003-110	Universal-Dichtungskappen, grau, blau oder rot, VE 10 Stk. Universal sealing caps, grey, blue or red, PU 10 pcs		



Passende Trokardorne
Suitable trocar spikes

Bestell-Nr. Ordering no.	Bezeichnung Description		
TR350-110	Sicherheitstrokardorn Safety trocar spike		
TR300-110	Trokardorn, konisch Trocar spike, conical point		
TR310-110	Trokardorn mit Dreikantschliff Trocar spike with triangular cut		
TR330-110	Trokardorn für Hasson, kegelförmig stumpf Trocar spike for Hasson, conical blunt		

Trokardorne und Hülsen frei kombinierbar
Trocar spikes and sleeves free combinable

Trokare aus Metall, für Instrumente mit Ø12 mm

Trocars made of metal, for instruments with Ø12 mm



12

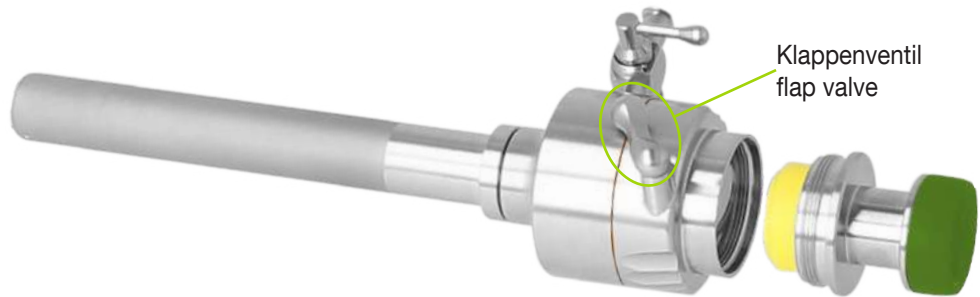

Trokar, ohne Dorn
Trocar, without spike

Bestell-Nr. Ordering no.	Bezeichnung Description	Nutzlänge Working length	
TR240-125	Trokar, Rohr glatt, mit Absperrhahn Trocar, tube plain, with stopcock	98 mm	
TR240-325	Trokarrohr mit Gewinde (Metall) Trocar tube threaded (metal)		
RZ003-312 RZ003-125	Universal-Dichtungskappen, grau oder grün, VE 10 Stk. Universal Sealing caps, grey or green, PU 10 pcs		
RZ005-125	Dichtungsring, gelb, VE 10 Stk. Sealing ring, yellow, PU 10 pcs		
RZ006-125	Dichtungsring für Gehäuse, 30 x 1.5 mm, VE 10 Stk. Sealing ring for housing, 30 x 1.5 mm, PU 10 pcs		



Passende Trokardorne
Suitable trocar spikes

Bestell-Nr. Ordering no.	Bezeichnung Description		
TR350-125	Sicherheitstrokardorn Safety trocar spike		
TR300-125	Trokardorn, konisch Trocar spike, conical point		
TR310-125	Trokardorn mit Dreikantschliff Trocar spike with triangular cut		
TR330-125	Trokardorn für Hasson, kegelförmig stumpf Trocar spike for Hasson, conical blunt		

Trokardorne und Hülsen frei kombinierbar
Trocar spikes and sleeves free combinable

Trokare aus Metall, für Instrumente mit Ø 12 mm

Trocars made of metal, for instruments with Ø 12 mm



Trokare, ohne Dorn
Trocars, without spike

Bestell-Nr. Ordering no.	Bezeichnung Description	Nutzlänge Working length	
EP150-267	Trokar, Rohr glatt, mit Absperrhahn Trocar, tube plain, with stopcock	108 mm	
EP151-267	Trokar, Rohr mit Gewinde, mit Absperrhahn Trocar, tube threaded, with stopcock	108 mm	
EP400-404	Passendes Silikonventil, VE 10 Stk. (Einweg) Suitable silicone valve, PU 5 pcs (disposable)		
RZ003-312 RZ003-125	Universal-Dichtungskappen, grau oder grün, VE 10 Stk. Universal sealing caps, grey or green, PU 10 pcs		



Passende Trokardorne
Suitable trocar spikes

Bestell-Nr. Ordering no.	Bezeichnung Description		
TR350-125	Sicherheitstrokardorn Safety trocar spike		
TR300-125	Trokardorn, konisch Trocar spike, conical point		
TR310-125	Trokardorn mit Dreikantschliff Trocar spike with triangular cut		
TR330-125	Trokardorn für Hasson, kegelförmig stumpf Trocar spike for Hasson, conical blunt		

Trokardorne und Hülsen frei kombinierbar
Trocar spikes and sleeves free combinable

Reduzier-Systeme für alle RUDOLF Trokare Reducing systems for all RUDOLF trocars

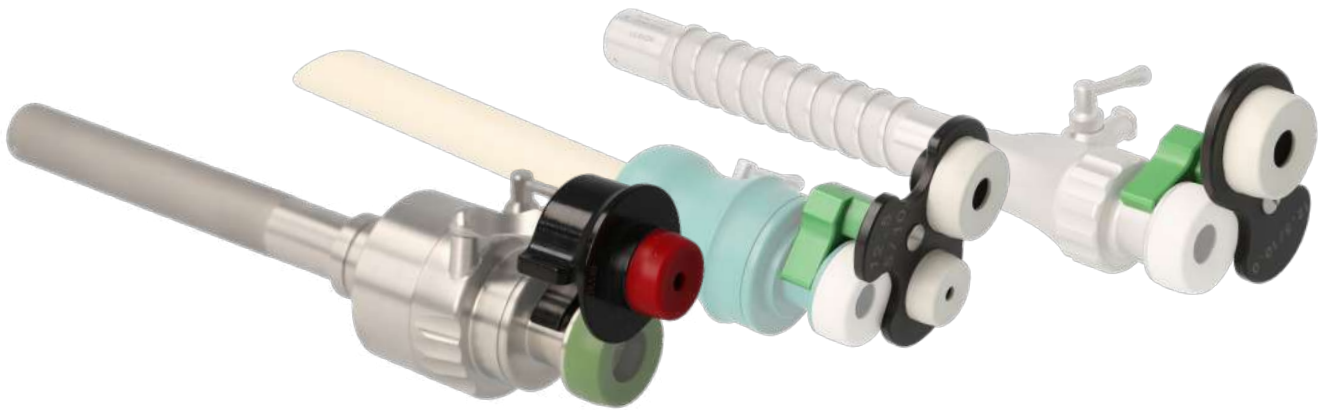

Bestell-Nr. Ordering no.	Bezeichnung Description	für Instrumente mit Ø for instruments with Ø	
TR420-001	Reduzierer Reducers	10 → 5 mm	
TR420-003	Reduzierer Reducers	12 → 5 mm	
TR421-001	Doppel-Reduzierer Double reducer	12 → 10 mm / 5 mm	
TR422-001	Schiebe-Reduzierer Slide reducer	12 → 5 mm	
TR410-002	Reduzier-Aufsatz ohne Schlaufe Reducer tube without loop	10 mm → 5 mm	
TR411-002	Reduzier-Aufsatz mit Schlaufe Reducer tube with loop	10 mm → 5 mm	

Appendix-Extraktor und Reduzierhülse für alle Trokarhülsen
Appendix extractor and reducer tube for all trocar sleeves

Bestell-Nr. Ordering no.	für Instrumente mit Ø for instruments with Ø	
TR405-002	10 mm → 5 mm	



Index

Alphabetischer Index, Nummern Index
Alphabetical Index, Numerical Index
IN1 – IN8

Search



01

Veres-Kanülen
Veres Cannulas
LP1 - LP3



02

Optiken
Optics
LP5 - LP10



03

Trokare und Zubehör
Trocars and Accessories
LP11 - LP29



04

Screw-In Instrumente
Screw-In Instruments
LP31 - LP56



05

Saug- und Spülinstrumente
Suction and Irrigation
LP57 - LP61

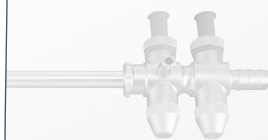

06

HF Monopolar
HF Monopolar
LP63 - LP69

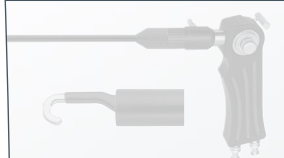

07

HF Bipolar
HF Bipolar
LP71 - LP76



08

Naht- und Clipanlegeinstrumente
Suturing / Clip Applicators
LP77 - LP85

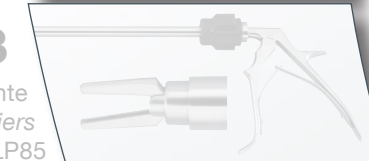

09

Diverse Laparoskopie-Instrumente
Various Laparoscopy Instruments
LP85 - LP93

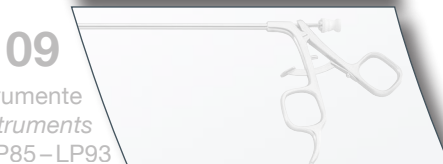

10

Zubehör
Accessories
LP95 - LP100

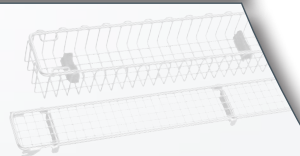

ZK 583-02 EN

Gerätekatalog
Devices Catalogue
LP101

RUDOLF



Endoscopy Devices
Endoscopy Devices

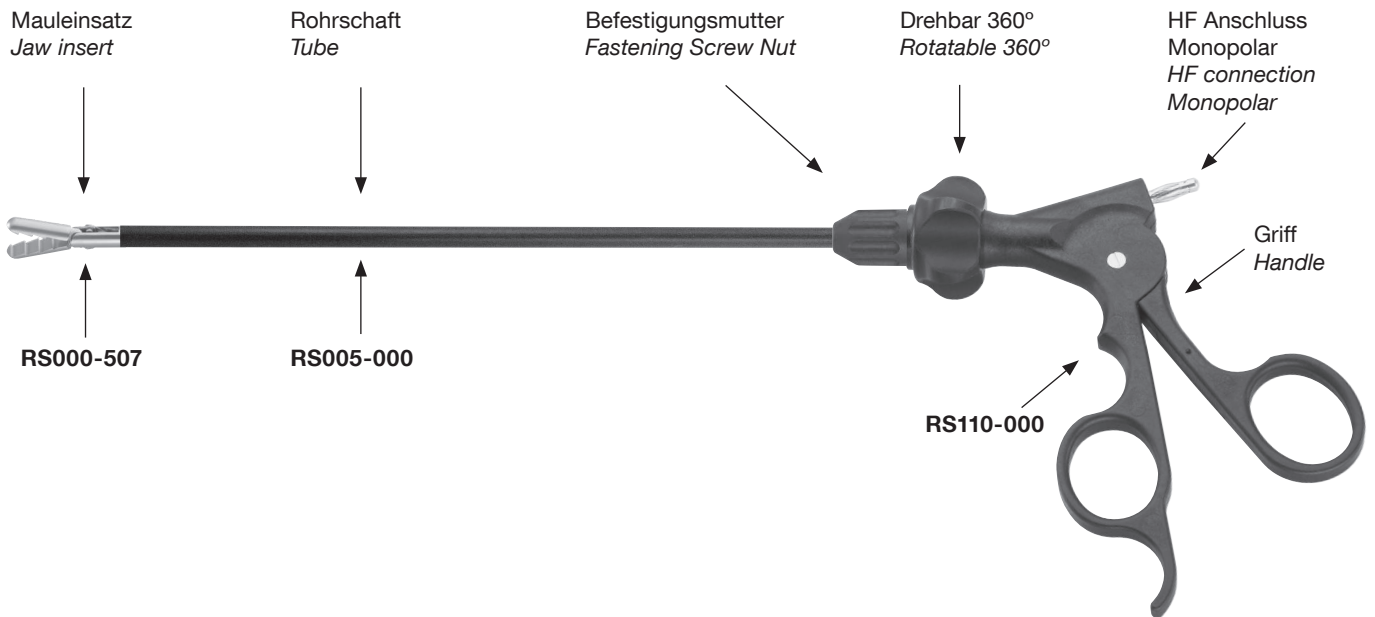

Aufbau der Bestell-Nr. bei Bestellung von Komplett-Instrumenten (Beispiel):
 Principle of creating the Ordering no. for ordering complete instruments (Example):

Mauleinsatz Jaw insert	Rohrschaft Tube	Griff Handle	Komplett-Instrument Complete instrument
RS000-507	RS005-000	RS110-000	RS115-507



Dreiteilig – Drehbar – Auseinandernehmbar

- Leicht zerlegbar in 3 Teile (Griff, Rohrschaft, Mauleinsatz)
- Teile untereinander austauschbar und kompatibel
- Große Anzahl von Modellen
- Vielfalt von Kombinationsmöglichkeiten
- Kostengünstige Ersatzbeschaffung für Einzelteile

Threepart – Rotatable – Detachable

- Easily detachable into 3 parts (handle, tube, jaw insert)
- All parts are exchangeable and compatible
- Wide range of models
- Great variety of possible combinations
- Cost-saving spare parts procurement

Rohrschäfte mit Zubehör

Tubes with accessories



Rohrschaft, mit Befestigungsmutter für RUDOLF SCREW-IN System, isoliert
 Tubes, with fastening screw nut for RUDOLF SCREW-IN System, isolated

Durchmesser Diameter	Nutzlänge Working length	Bestell-Nr. Ordering no.
Ø 5 mm	330 mm	RS005-000
Ø 5 mm	450 mm	RS007-000
Ø 10 mm	330 mm	RS009-000

Befestigungsmuttern
 Fastening screws nuts

Ø 5mm	Ø 10mm	Farbe Colour
RS000-011	RS000-021	Schwarz black 
RS000-012	RS000-022	Rot red 
RS000-013	RS000-023	Grün green 
RS000-014	RS000-024	Blau blue 

Spülansatz, für Rohrschäfte mit Befestigungsmutter
 Rinsing adapter, for tubes with fastening screw nut

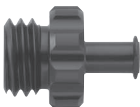
RS000-010	Spülansatz mit Luer-Lock, für Ø 5 + 10 mm Rinsing adapter with Luer-Lock, for Ø 5 + 10 mm	
-----------	--	---

Bestell-Nr. Ordering no.		
<p>RS110-000</p>	<p>Der RUDOLF Kunststoff-Griff <u>ohne Sperre</u> Einfach, ergonomisch, sicher, drehbar <i>The RUDOLF plastic handle <u>without ratchet</u></i> <i>Simple, ergonomic, safe, rotatable</i></p>	
<p>RS120-000</p>	<p>Der RUDOLF Kunststoff-Griff <u>mit Sperre</u> Einfach, ergonomisch, sicher, drehbar <i>The RUDOLF plastic handle <u>with ratchet</u></i> <i>Simple, ergonomic, safe, rotatable</i></p>	
<p>RS130-000</p>	<p>Der RUDOLF Kunststoff-Griff <u>mit Klapp-Sperre</u> Einfach, ergonomisch, sicher, drehbar <i>The RUDOLF plastic handle <u>with French ratchet</u></i> <i>Simple, ergonomic, safe, rotatable</i></p>	
<p>RS210-000</p>	<p>RUDOLF Comfort-Griff <u>mit Comfort-Sperre</u> Kunststoff, drehbar, mit Doppelfeder <i>RUDOLF comfort handle <u>with Comfort ratchet</u></i> <i>Plastic, rotatable, double spring</i></p>	
<p>RS220-000</p>	<p>RUDOLF Comfort-Griff <u>ohne Sperre</u> Kunststoff, drehbar, mit Doppelfeder <i>RUDOLF comfort handle <u>without ratchet</u></i> <i>Plastic, rotatable, double spring</i></p>	



Grundsätzlich sind alle Griffe mit allen **RUDOLF** Rohrschäften und Einsätzen kombinierbar.
*All handles can basically be combined with all **RUDOLF** tubes and inserts.*

Präparier- und Fasszangen, divers Dissecting and Grasping Forceps, diverse



Griff, allein
Handle, only

RS110-000	RS120-000	RS130-000	RS210-000	RS220-000

Mauleinsatz, allein
Jaw insert, only

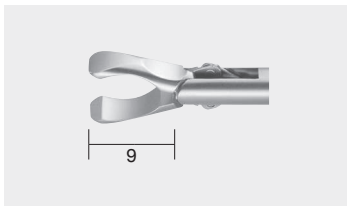

Set Nummer = Instrument besteht aus Handgriff + Rohrschaft + Einsatz
Set Number = Instrument consists of Handle + Tube + Insert

Fasszange, glatt, stumpf, doppelbeweglich, Ø 5 mm
Grasping forceps, smooth, blunt, double action, Ø 5 mm

330 mm	RS000-559
450 mm	RS000-759

RS115-559	RS125-559	RS135-559	RS215-559	RS225-559
RS117-759	RS127-759	RS137-759	RS217-759	RS227-759

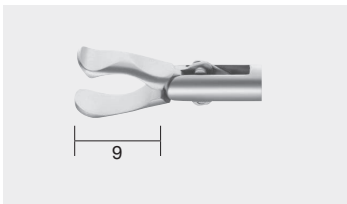

Fasszange, glatt, doppelbeweglich, Ø 5 mm
Grasping forceps, smooth, double action, Ø 5 mm

330 mm	RS000-558
450 mm	RS000-758

RS115-558	RS125-558	RS135-558	RS215-558	RS225-558
RS117-758	RS127-758	RS137-758	RS217-758	RS227-758



Präparier- und Fasszange, Reddick-Olsen, starkes Modell, doppelbeweglich, Ø 5 mm
Dissecting and grasping forceps, Reddick-Olsen, strong model, double action, Ø 5 mm

330 mm	RS000-561
450 mm	RS000-761

RS115-561	RS125-561	RS135-561	RS215-561	RS225-561
RS117-761	RS127-761	RS137-761	RS217-761	RS227-761



Fasszange, gerieft, doppelbeweglich, Ø 5 mm
Grasping forceps, grooved, double action, Ø 5 mm

330 mm	RS000-560
450 mm	RS000-760

RS115-560	RS125-560	RS135-560	RS215-560	RS225-560
RS117-760	RS127-760	RS137-760	RS217-760	RS227-760

Präparier- und Faszangen, divers Dissecting and Grasping Forceps, diverse



Griff, allein
Handle, only

RS110-000	RS120-000	RS130-000	RS210-000	RS220-000

Mauleinsatz, allein
Jaw insert, only

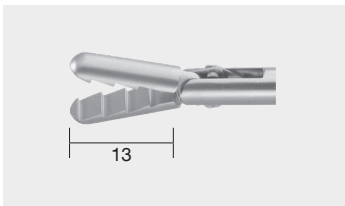

Set Nummer = Instrument besteht aus Handgriff + Rohrschaft + Einsatz
Set Number = Instrument consists of Handle + Tube + Insert

Faszange, Alligator, doppelbeweglich, Ø 5 mm
Grasping forceps, Alligator, double action, Ø 5 mm

330 mm	RS000-507
450 mm	RS000-707

RS115-507	RS125-507	RS135-507	RS215-507	RS225-507
RS117-707	RS127-707	RS137-707	RS217-707	RS227-707

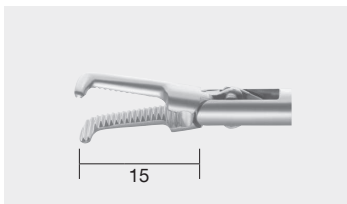

Präparier- und Faszange, Mixer, doppelbeweglich, Ø 5 mm
Dissecting and grasping forceps, Mixer, double action, Ø 5 mm

330 mm	RS000-520
450 mm	RS000-720

RS115-520	RS125-520	RS135-520	RS215-520	RS225-520
RS117-720	RS127-720	RS137-720	RS217-720	RS227-720

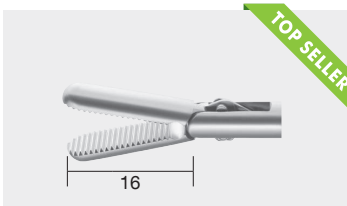

Präparier- und Faszange, gerieft, doppelbeweglich, Ø 5 mm
Dissecting and grasping forceps, grooved, double action, Ø 5 mm

330 mm	RS000-502
450 mm	RS000-702

RS115-502	RS125-502	RS135-502	RS215-502	RS225-502
RS117-702	RS127-702	RS137-702	RS217-702	RS227-702

Präparier- und Fasszangen, divers Dissecting and Grasping Forceps, diverse



Griff, allein
Handle, only

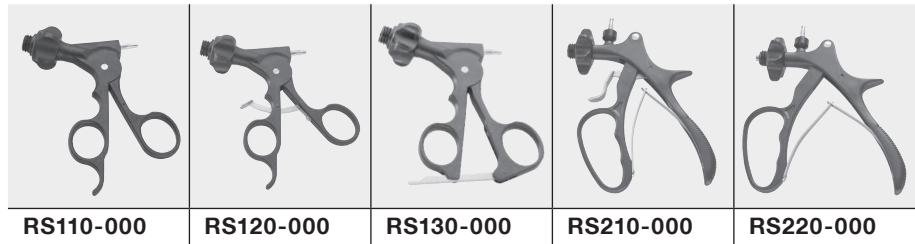

Mauleinsatz, allein
Jaw insert, only

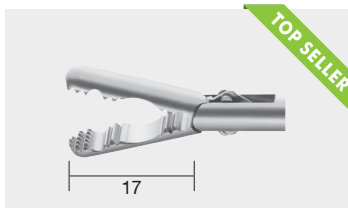

330 mm	RS000-535
450 mm	RS000-735

Set Nummer = Instrument besteht aus Handgriff + Rohrschaft + Einsatz
Set Number = Instrument consists of Handle + Tube + Insert

Fasszange, universal, doppelbeweglich, Ø 5 mm
Grasping forceps, universal, double action, Ø 5 mm

RS115-535	RS125-535	RS135-535	RS215-535	RS225-535
RS117-735	RS127-735	RS137-735	RS217-735	RS227-735

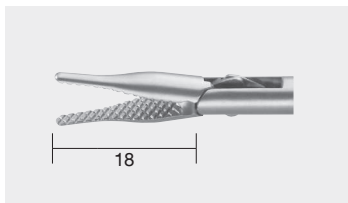

330 mm	RS000-516
450 mm	RS000-716

Präparier- und Fasszange, schlank, doppelbeweglich, Ø 5 mm
Dissecting and grasping forceps, slim, double action, Ø 5 mm

RS115-516	RS125-516	RS135-516	RS215-516	RS225-516
RS117-716	RS127-716	RS137-716	RS217-716	RS227-716

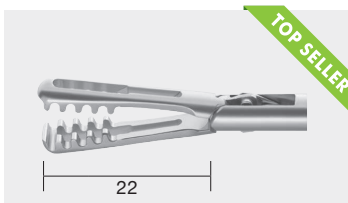

330 mm	RS000-546
450 mm	RS000-746

Fasszange, mehrfach gezahnt, gefenestert, doppelbeweglich, Ø 5 mm
Grasping forceps, toothed, fenestrated, double action, Ø 5 mm

RS115-546	RS125-546	RS135-546	RS215-546	RS225-546
RS117-746	RS127-746	RS137-746	RS217-746	RS227-746

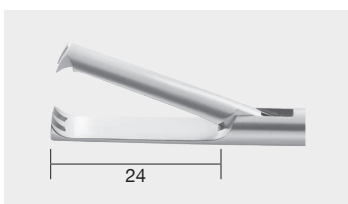

330 mm	RS000-501
450 mm	RS000-701

Krallengreifer, 2x3 Zähne, einfach beweglich, Ø 5 mm
Claw grasping forceps, 2x3 teeth, single action, Ø 5 mm

RS115-501	RS125-501	RS135-501	RS215-501	RS225-501
RS117-701	RS127-701	RS137-701	RS217-701	RS227-701

Präparier- und Faszangen, schlank gerieft

Dissecting and Grasping Forceps, slim grooved



Griff, allein
Handle, only



Mauleinsatz, allein
Jaw insert, only



330 mm	RS000-505
450 mm	RS000-705

Set Nummer = Instrument besteht aus Handgriff + Rohrschaft + Einsatz
Set Number = Instrument consists of Handle + Tube + Insert

Präparier- und Faszange, schlank, gerade, einfach beweglich, Ø 5 mm
Dissecting and grasping forceps, slim, straight, single action, Ø 5 mm

RS115-505	RS125-505	RS135-505	RS215-505	RS225-505
RS117-705	RS127-705	RS137-705	RS217-705	RS227-705

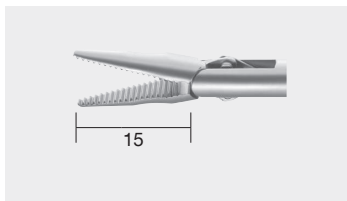

330 mm	RS000-515
450 mm	RS000-715

Präparier- und Faszange, Delphin, doppelbeweglich, Ø 5 mm
Dissecting and grasping forceps, Dolphin, double action, Ø 5 mm

RS115-515	RS125-515	RS135-515	RS215-515	RS225-515
RS117-715	RS127-715	RS137-715	RS217-715	RS227-715

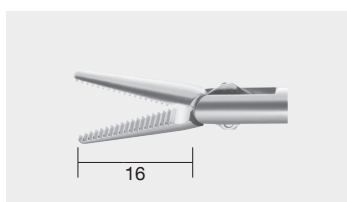

330 mm	RS000-503
450 mm	RS000-703

Präparier- und Faszange, gerieft, doppelbeweglich, Ø 5 mm
Dissecting and grasping forceps, grooved, double action, Ø 5 mm

RS115-503	RS125-503	RS135-503	RS215-503	RS225-503
RS117-703	RS127-703	RS137-703	RS217-703	RS227-703

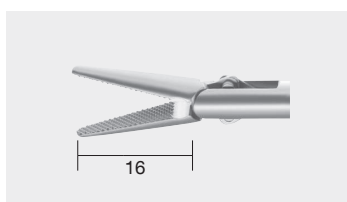

330 mm	RS000-504
450 mm	RS000-704

Präparier- und Faszange, feine atraumatische Zählung, doppelbeweglich, Ø 5 mm
Dissecting and grasping forceps, fine atraumatic serration, double action, Ø 5 mm

RS115-504	RS125-504	RS135-504	RS215-504	RS225-504
RS117-704	RS127-704	RS137-704	RS217-704	RS227-704

Präparier- und Fasszangen, gerieft mit Löffel

Dissecting and Grasping Forceps, grooved with spoon



Griff, allein
Handle, only



Mauleinsatz, allein
Jaw insert, only

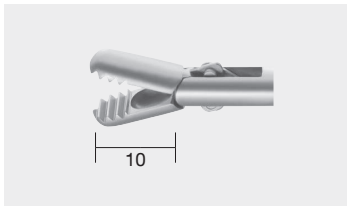

330 mm	RS000-506
450 mm	RS000-706

Set Nummer = Instrument besteht aus Handgriff + Rohrschaft + Einsatz
Set Number = Instrument consists of Handle + Tube + Insert

Fasszange, gerieft, mit Löffel, doppelbeweglich, Ø 5 mm
Grasping forceps, grooved, with spoon, double action, Ø 5 mm

RS115-506	RS125-506	RS135-506	RS215-506	RS225-506
RS117-706	RS127-706	RS137-706	RS217-706	RS227-706

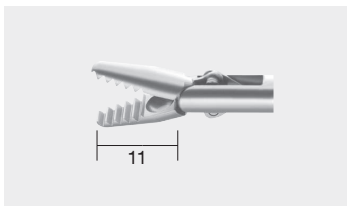

330 mm	RS000-509
450 mm	RS000-709

Fasszange, gerieft, mit Löffel, doppelbeweglich, Ø 5 mm
Grasping forceps, grooved, with spoon, double action, Ø 5 mm

RS115-509	RS125-509	RS135-509	RS215-509	RS225-509
RS117-709	RS127-709	RS137-709	RS217-709	RS227-709

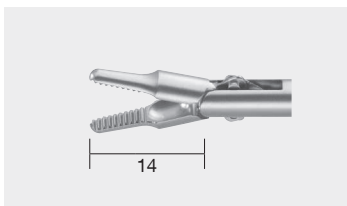

330 mm	RS000-517
450 mm	RS000-717

Präparier- und Fasszange, Delphin, kurz mit Löffel, doppelbeweglich, Ø 5 mm
Dissecting and grasping forceps, Dolphin, short with spoon, double action, Ø 5 mm

RS115-517	RS125-517	RS135-517	RS215-517	RS225-517
RS117-717	RS127-717	RS137-717	RS217-717	RS227-717

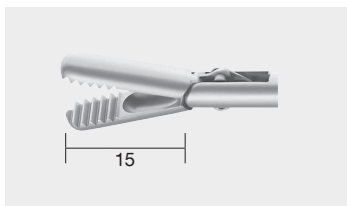

330 mm	RS000-508
450 mm	RS000-708

Fasszange, gerieft, mit Löffel, lang, doppelbeweglich, Ø 5 mm
Grasping forceps, grooved, with spoon, long, double action, Ø 5 mm

RS115-508	RS125-508	RS135-508	RS215-508	RS225-508
RS117-708	RS127-708	RS137-708	RS217-708	RS227-708

Präparier- und Fasszangen, Maryland Dissecting and Grasping Forceps, Maryland



Griff, allein
Handle, only



Mauleinsatz, allein
Jaw insert, only

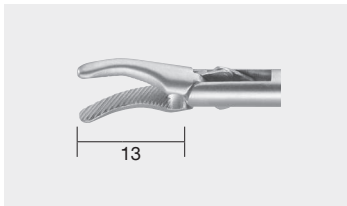

Set Nummer = Instrument besteht aus Handgriff + Rohrschaft + Einsatz
Set Number = Instrument consists of Handle + Tube + Insert

Präparier- und Fasszange, kreuzgerieft, gebogen, doppelbeweglich, Ø 5 mm
Dissecting and grasping forceps, cross-serrated, curved, double action, Ø 5 mm

330 mm	RS000-527
450 mm	RS000-727

RS115-527	RS125-527	RS135-527	RS215-527	RS225-527
RS117-727	RS127-727	RS137-727	RS217-727	RS227-727

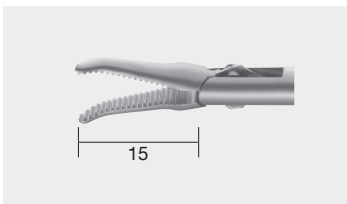

Präparier- und Fasszange, Maryland, schlank, gebogen, doppelbeweglich, Ø 5 mm
Dissecting and grasping forceps, Maryland, slim, curved, double action, Ø 5 mm

330 mm	RS000-526
450 mm	RS000-726

RS115-526	RS125-526	RS135-526	RS215-526	RS225-526
RS117-726	RS127-726	RS137-726	RS217-726	RS227-726

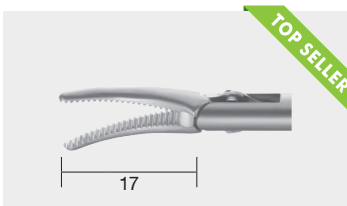

Präparier- und Fasszange, Maryland (Standard), gebogen, doppelbeweglich, Ø 5 mm
Dissecting and grasping forceps, Maryland (standard), curved, double action, Ø 5 mm

330 mm	RS000-525
450 mm	RS000-725

RS115-525	RS125-525	RS135-525	RS215-525	RS225-525
RS117-725	RS127-725	RS137-725	RS217-725	RS227-725

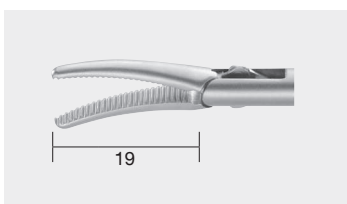

Präparier- und Fasszange, Maryland, extra lang, gebogen, doppelbeweglich, Ø 5 mm
Dissecting and grasping forceps, Maryland, extra long, curved, double action, Ø 5 mm

330 mm	RS000-528
450 mm	RS000-728

RS115-528	RS125-528	RS135-528	RS215-528	RS225-528
RS117-728	RS127-728	RS137-728	RS217-728	RS227-728

Präparier- und Fasszangen, DeBakey

Dissecting and Grasping Forceps, DeBakey



Griff, allein
Handle, only

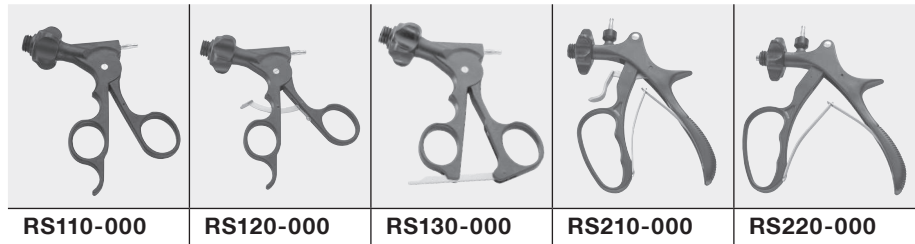

Set Nummer = Instrument besteht aus Handgriff + Rohrschaft + Einsatz
Set Number = Instrument consists of Handle + Tube + Insert

Mauleinsatz, allein
Jaw insert, only

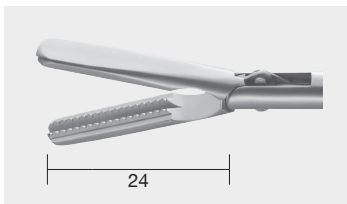

Fasszange, DeBakey, atraumatisch, doppelbeweglich, Ø 5 mm
Grasping forceps, atraumatic, double action, Ø 5 mm

330 mm	RS000-531
450 mm	RS000-731

RS115-531	RS125-531	RS135-531	RS215-531	RS225-531
RS117-731	RS127-731	RS137-731	RS217-731	RS227-731

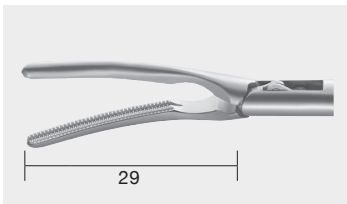

Präparier- und Fasszange, Maryland-DeBakey, gebogen, atraumatisch, doppelbeweglich, Ø 5 mm
Dissecting and grasping forceps, Maryland-DeBakey, curved, atraumatic, double action, Ø 5 mm

330 mm	RS000-529
450 mm	RS000-729

RS115-529	RS125-529	RS135-529	RS215-529	RS225-529
RS117-729	RS127-729	RS137-729	RS217-729	RS227-729

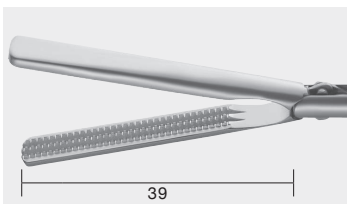

Fasszange, DeBakey, atraumatisch, doppelbeweglich, Ø 5 mm
Grasping forceps, DeBakey, atraumatic, double action, Ø 5 mm

330 mm	RS000-530
450 mm	RS000-730

RS115-530	RS125-530	RS135-530	RS215-530	RS225-530
RS117-730	RS127-730	RS137-730	RS217-730	RS227-730

Präparier- und Fasszangen, mit Zähne Dissecting and Grasping Forceps, with teeth



Griff, allein
Handle, only



Mauleinsatz, allein
Jaw insert, only

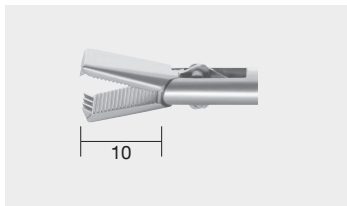

Fasszange, Cobra, 2x4 Zähne, doppelbeweglich, Ø 5 mm
Grasping forceps, Cobra, 2x4 teeth, double action, Ø 5 mm

330 mm	RS000-533
450 mm	RS000-733

RS115-533	RS125-533	RS135-533	RS215-533	RS225-533
RS117-733	RS127-733	RS137-733	RS217-733	RS227-733



Fasszange, Allis, mit Zähnen, doppelbeweglich, Ø 5 mm
Grasping forceps, Allis, with teeth, double action, Ø 5 mm

330 mm	RS000-536
450 mm	RS000-736

RS115-536	RS125-536	RS135-536	RS215-536	RS225-536
RS117-736	RS127-736	RS137-736	RS217-736	RS227-736

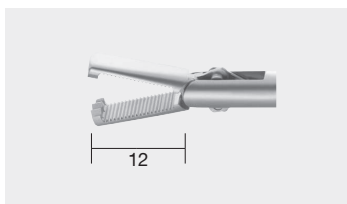

Fasszange, mit Zähnen, doppelbeweglich, Ø 5 mm
Grasping forceps, with teeth, double action, Ø 5 mm

330 mm	RS000-534
450 mm	RS000-734

RS115-534	RS125-534	RS135-534	RS215-534	RS225-534
RS117-734	RS127-734	RS137-734	RS217-734	RS227-734

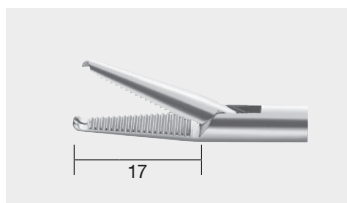

Fasszange, 1x2 Zähne, einfach beweglich, Ø 5 mm
Grasping forceps, 1x2 teeth, single action, Ø 5 mm

330 mm	RS000-532
450 mm	RS000-732

RS115-532	RS125-532	RS135-532	RS215-532	RS225-532
RS117-732	RS127-732	RS137-732	RS217-732	RS227-732

Präparier- und Faszangen, atraumatisch Dissecting and Grasping Forceps, atraumatic



Griff, allein
Handle, only

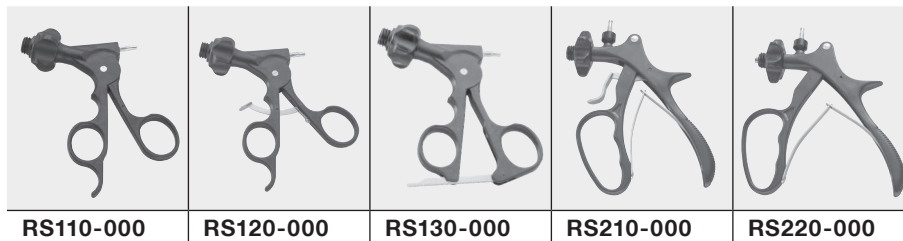

Mauleinsatz, allein
Jaw insert, only

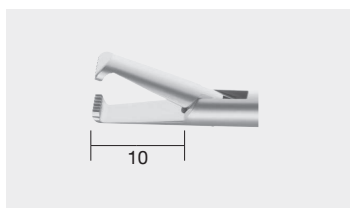

330 mm	RS000-537
450 mm	RS000-737

Set Nummer = Instrument besteht aus Handgriff + Rohrschaft + Einsatz
Set Number = Instrument consists of Handle + Tube + Insert

Fasszange, Allis, einfach beweglich, Ø 5 mm
Grasping forceps, Allis, single action, Ø 5 mm

RS115-537	RS125-537	RS135-537	RS215-537	RS225-537
RS117-737	RS127-737	RS137-737	RS217-737	RS227-737

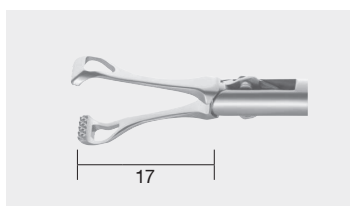

330 mm	RS000-542
450 mm	RS000-742

Fasszange, Babcock, gezahnt, sehr feines Modell, doppelbeweglich, Ø 5 mm
Grasping forceps, Babcock, serrated, very fine model, double action, Ø 5 mm

RS115-542	RS125-542	RS135-542	RS215-542	RS225-542
RS117-742	RS127-742	RS137-742	RS217-742	RS227-742

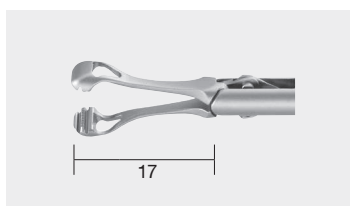

330 mm	RS000-543
450 mm	RS000-743

Fasszange, Babcock, atraumatisch, sehr feines Modell, doppelbeweglich, Ø 5 mm
Grasping forceps, Babcock, atraumatic, very fine model, double action, Ø 5 mm

RS115-543	RS125-543	RS135-543	RS215-543	RS225-543
RS117-743	RS127-743	RS137-743	RS217-743	RS227-743

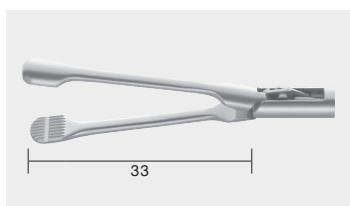

330 mm	RS000-538
450 mm	RS000-738

Fasszange, atraumatisch, doppelbeweglich, Ø 5 mm
Grasping forceps, atraumatic, double action, Ø 5 mm

RS115-538	RS125-538	RS135-538	RS215-538	RS225-538
RS117-738	RS127-738	RS137-738	RS217-738	RS227-738

Präparier- und Fasszangen, gewellt

Dissecting and Grasping Forceps, rippled



Griff, allein
Handle, only

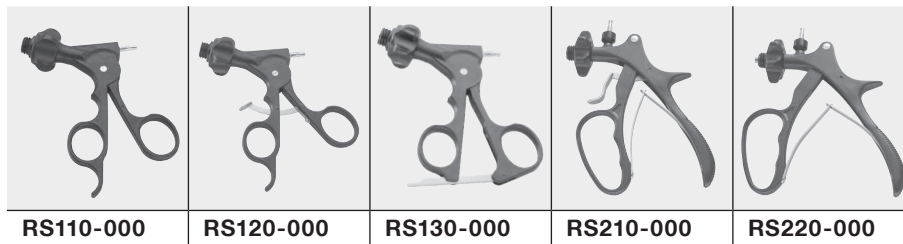

Set Nummer = Instrument besteht aus Handgriff + Rohrschaft + Einsatz
Set Number = Instrument consists of Handle + Tube + Insert

Mauleinsatz, allein
Jaw insert, only

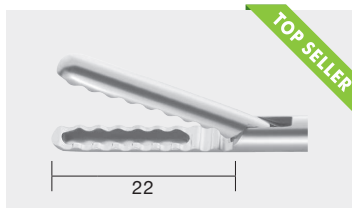

Fasszange, gewellt, Löffelform, einfach beweglich, Ø 5 mm
Grasping forceps, rippled, spoon shape, single action, Ø 5 mm

330 mm	RS000-549
450 mm	RS000-749

RS115-549	RS125-549	RS135-549	RS215-549	RS225-549
RS117-749	RS127-749	RS137-749	RS217-749	RS227-749

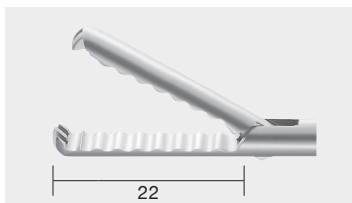

Fasszange, gewellt, mit Zähnen, einfach beweglich, Ø 5 mm
Grasping forceps, rippled, with teeth, single action, Ø 5 mm

330 mm	RS000-547
450 mm	RS000-747

RS115-547	RS125-547	RS135-547	RS215-547	RS225-547
RS117-747	RS127-747	RS137-747	RS217-747	RS227-747

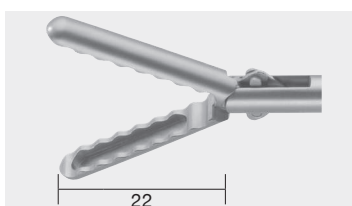

Fasszange, gewellt, Löffelform, doppelbeweglich, Ø 5 mm
Grasping forceps, rippled, spoon shape, double action, Ø 5 mm

330 mm	RS000-550
450 mm	RS000-750

RS115-550	RS125-550	RS135-550	RS215-550	RS225-550
RS117-750	RS127-750	RS137-750	RS217-750	RS227-750

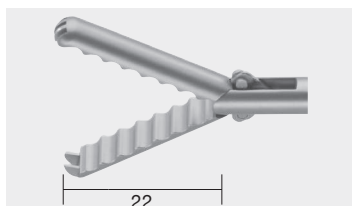

Fasszange, gewellt, mit Zähnen, doppelbeweglich, Ø 5 mm
Grasping forceps, rippled, with teeth, double action, Ø 5 mm

330 mm	RS000-548
450 mm	RS000-748

RS115-548	RS125-548	RS135-548	RS215-548	RS225-548
RS117-748	RS127-748	RS137-748	RS217-748	RS227-748

Präparier- und Faszangen, gefenstert Dissecting and Grasping Forceps, fenestrated



Griff, allein
Handle, only

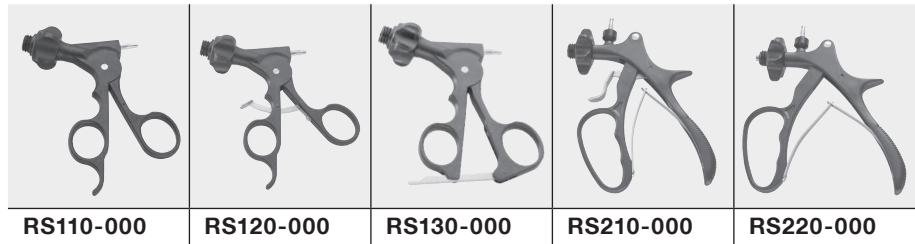

Mauleinsatz, allein
Jaw insert, only

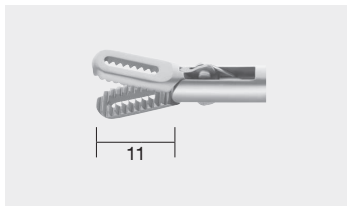

Set Nummer = Instrument besteht aus Handgriff + Rohrschaft + Einsatz
Set Number = Instrument consists of Handle + Tube + Insert

Faszange, gefenstert, doppelbeweglich, Ø 5 mm
Grasping forceps, fenestrated, double action, Ø 5 mm

330 mm	RS000-564
450 mm	RS000-764

RS115-564	RS125-564	RS135-564	RS215-564	RS225-564
RS117-764	RS127-764	RS137-764	RS217-764	RS227-764



Präparier- und Faszange, besonders fein gerieft, einfach beweglich, Ø 5 mm
Dissecting and grasping forceps, extra fine grooving, single action, Ø 5 mm

330 mm	RS000-566
450 mm	RS000-766

RS115-566	RS125-566	RS135-566	RS215-566	RS225-566
RS117-766	RS127-766	RS137-766	RS217-766	RS227-766

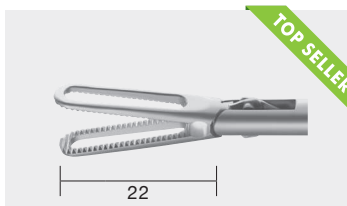

Präparier- und Faszange, besonders fein gerieft, doppelbeweglich, Ø 5 mm
Dissecting and grasping forceps, extra fine grooving, double action, Ø 5 mm

330 mm	RS000-567
450 mm	RS000-767

RS115-567	RS125-567	RS135-567	RS215-567	RS225-567
RS117-767	RS127-767	RS137-767	RS217-767	RS227-767

Präparier- und Fasszangen, gefenstert Dissecting and Grasping Forceps, fenestrated



Griff, allein
Handle, only



Mauleinsatz, allein
Jaw insert, only

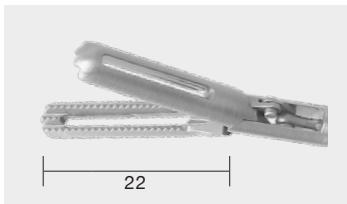

330 mm	RS000-565
450 mm	RS000-765

Set Nummer = Instrument besteht aus Handgriff + Rohrschaft + Einsatz
Set Number = Instrument consists of Handle + Tube + Insert

Hunter Darmfasszange, atraumatisch, gefenstert, doppelbeweglich, Ø 5 mm
Hunter Bowel Grasping, atraumatic, fenestrated, double action, Ø 5 mm

RS115-565	RS125-565	RS135-565	RS215-565	RS225-565
RS117-765	RS127-765	RS137-765	RS217-765	RS227-765

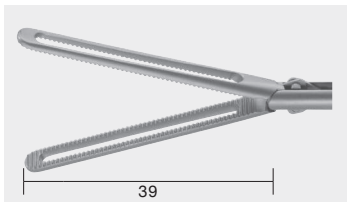

330 mm	RS000-569
450 mm	RS000-769

Präparier- und Fasszange, besonders fein gerieft, doppelbeweglich, Ø 5 mm
Dissecting and grasping forceps, extra fine grooving, double action, Ø 5 mm

RS115-569	RS125-569	RS135-569	RS215-569	RS225-569
RS117-769	RS127-769	RS137-769	RS217-769	RS227-769

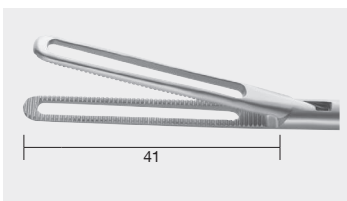

330 mm	RS000-568
450 mm	RS000-768

Präparier- und Fasszange, besonders fein gerieft, einfach beweglich, Ø 5 mm
Dissecting and grasping forceps, extra fine grooving, single action, Ø 5 mm

RS115-568	RS125-568	RS135-568	RS215-568	RS225-568
RS117-768	RS127-768	RS137-768	RS217-768	RS227-768

Probeexzisionszangen Biopsy Forceps



Griff, allein
Handle, only

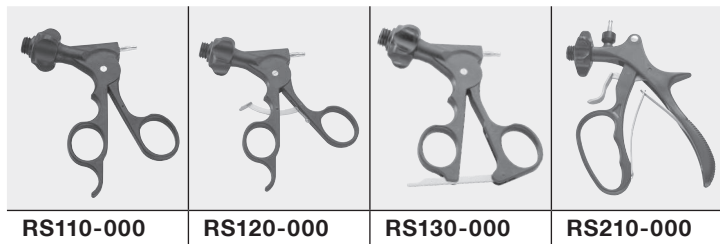

RS110-000

RS120-000

RS130-000

RS210-000

Mauleinsatz, allein
Jaw insert, only

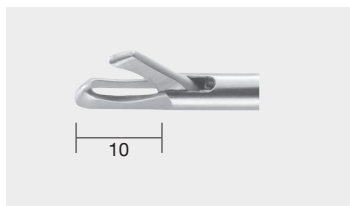

330 mm	RS000-555
450 mm	RS000-755

Set Nummer = Instrument besteht aus Handgriff + Rohrschaft + Einsatz
Set Number = Instrument consists of Handle + Tube + Insert

Probeexzisionszange, durchschneidend, einfach beweglich, Ø 5 mm
Biopsy forceps, through-cutting, single action, Ø 5 mm

RS115-555	RS125-555	RS135-555	RS215-555
RS117-755	RS127-755	RS137-755	RS217-755

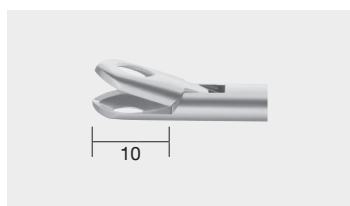

330 mm	RS000-554
450 mm	RS000-754

Probeexzisionszange, Weil-Blakesley, einfach beweglich, Ø 5 mm
Biopsy forceps, Weil-Blakesley, single action, Ø 5 mm

RS115-554	RS125-554	RS135-554	RS215-554
RS117-754	RS127-754	RS137-754	RS217-754

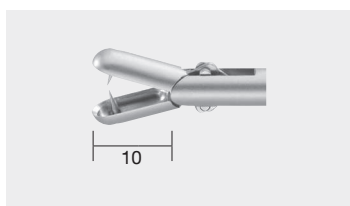

330 mm	RS000-552
450 mm	RS000-752

Probeexzisionszange, Löffelmaul mit Dorn, doppelbeweglich, Ø 5 mm
Biopsy forceps, spoon jaw with pin, double action, Ø 5 mm

RS115-552	RS125-552	RS135-552	RS215-552
RS117-752	RS127-752	RS137-752	RS217-752

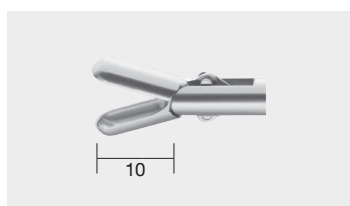

330 mm	RS000-553
450 mm	RS000-753

Probeexzisionszange, Löffelmaul, doppelbeweglich, Ø 5 mm
Biopsy forceps, spoon jaw, double action, Ø 5 mm

RS115-553	RS125-553	RS135-553	RS215-553
RS117-753	RS127-753	RS137-753	RS217-753



Griff, allein
Handle, only



RS110-000

RS220-000

Mauleinsatz, allein
Jaw insert, only

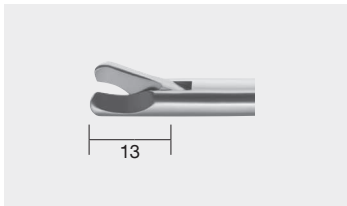

330 mm	RS000-593
450 mm	RS000-793

Set Nummer = Instrument besteht aus Handgriff + Rohrschaft + Einsatz
Set Number = Instrument consists of Handle + Tube + Insert

Hakenschere, einfach beweglich, Ø 5 mm
Hook scissors, single action, Ø 5 mm

RS115-593	RS225-593
RS117-793	RS227-793

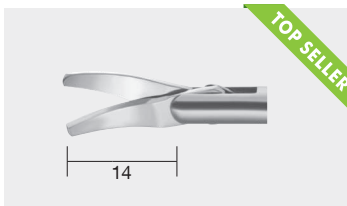

330 mm	RS000-591
450 mm	RS000-791

Schere, Metzenbaum, links gebogen, kurzes Modell, doppelbeweglich, Ø 5 mm
Scissors, Metzenbaum, curved left, short pattern, double action, Ø 5 mm

RS115-591	RS225-591
RS117-791	RS227-791

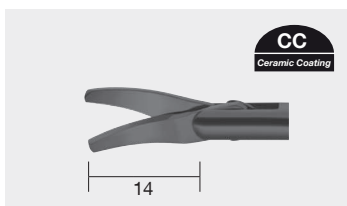

330 mm	RS000-591CC
450 mm	RS000-791CC

Schere, Metzenbaum, mit Keramikbeschichtung, links gebogen, kurzes Modell, doppelbeweglich, Ø 5 mm
Scissors, Metzenbaum, ceramic coated, curved left, short model, double action, Ø 5 mm

RS115-591CC	RS225-591CC
RS117-791CC	RS227-791CC



Griff, allein
Handle, only

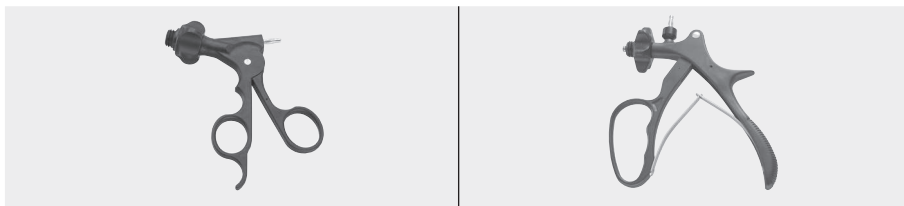

RS110-000

RS220-000

Mauleinsatz, allein
Jaw insert, only

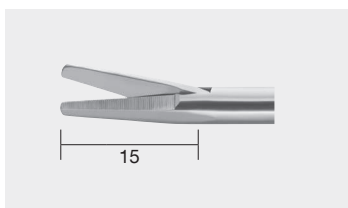

330 mm	RS000-586
450 mm	RS000-786

Set Nummer = Instrument besteht aus Handgriff + Rohrschaft + Einsatz
Set Number = Instrument consists of Handle + Tube + Insert

Peritonealschere, gerade, gezahnt, einfach beweglich, Ø 5 mm
Peritoneum scissors, straight, serrated, single action, Ø 5 mm

RS115-586	RS225-586
RS117-786	RS227-786

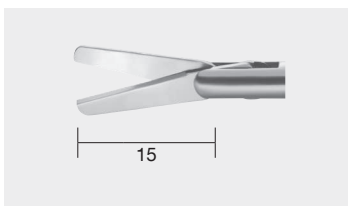

330 mm	RS000-585
450 mm	RS000-785

Schere, gerade, doppelbeweglich, Ø 5 mm
Scissors, straight, double action, Ø 5 mm

RS115-585	RS225-585
RS117-785	RS227-785

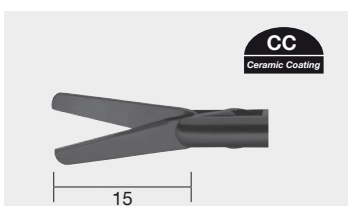

330 mm	RS000-585CC
450 mm	RS000-785CC

Schere, mit Keramikbeschichtung, gerade, doppelbeweglich, Ø 5 mm
Scissors, ceramic coated, straight, double action, Ø 5 mm

RS115-585CC	RS225-585CC
RS117-785CC	RS227-785CC



Griff, allein
Handle, only



RS110-000

RS220-000

Mauleinsatz, allein
Jaw insert, only

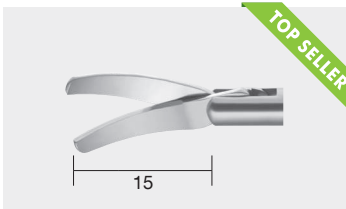

Set Nummer = Instrument besteht aus Handgriff + Rohrschaft + Einsatz
Set Number = Instrument consists of Handle + Tube + Insert

Schere, Metzenbaum, links gebogen, Standard, doppelbeweglich, Ø 5 mm
Scissors, Metzenbaum, curved left, standard, double action, Ø 5 mm

330 mm	RS000-590
450 mm	RS000-790

RS115-590	RS225-590
RS117-790	RS227-790

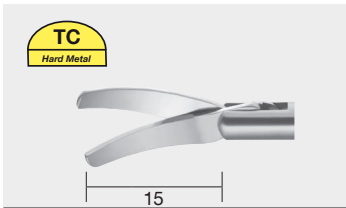

Schere, Metzenbaum, mit Hartmetalleinsatz, links gebogen,
Standard, doppelbeweglich, Ø 5 mm
Scissors, Metzenbaum, with hard metal inserts, curved left,
standard, double action, Ø 5 mm

330 mm	RS000-590TC
450 mm	RS000-790TC

RS115-590TC	RS225-590TC
RS117-790TC	RS227-790TC



Schere, Metzenbaum, mit Keramikbeschichtung, links gebogen,
Standard, doppelbeweglich, Ø 5 mm
Scissors, Metzenbaum, ceramic coated, curved left,
standard, double action, Ø 5 mm

330 mm	RS000-590CC
450 mm	RS000-790CC

RS115-590CC	RS225-590CC
RS117-790CC	RS227-790CC

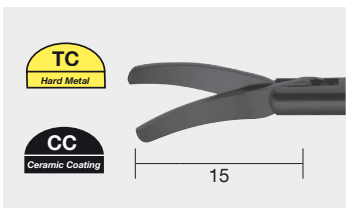

Schere, Metzenbaum, mit Keramikbeschichtung und Hartmetalleinsatz, links gebogen,
Standard, doppelbeweglich, Ø 5 mm
Scissors, Metzenbaum, ceramic coated and hard metal insert, curved left,
standard, double action, Ø 5 mm

330 mm	RS000-590TC/CC
450 mm	RS000-790TC/CC

RS115-590TC/CC	RS225-590TC/CC
RS117-790TC/CC	RS227-790TC/CC

Multifunktionales LAP Instrument, Piraña Cut

Multifunctional LAP Instrument, Piraña Cut



Griff, allein
Handle, only

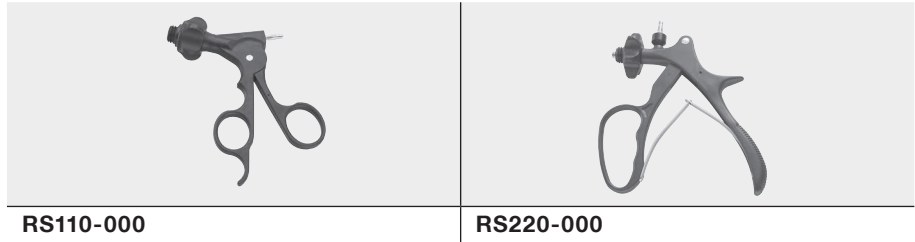

RS110-000

RS220-000

Mauleinsatz, allein
Jaw insert, only

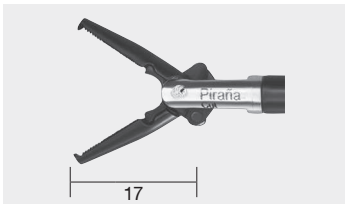

Set Nummer = Instrument besteht aus Handgriff + Rohrschaft + Einsatz
Set Number = Instrument consists of Handle + Tube + Insert

Multifunktionale Zange Piraña Cut, 1:2 Zähne, doppelbeweglich, Ø 5 mm
Multifunctional Forceps Piraña Cut, 1:2 teeth, double action, Ø 5 mm

330 mm	RS000-595
450 mm	RS000-795

RS115-595	RS225-595
RS117-795	RS227-795

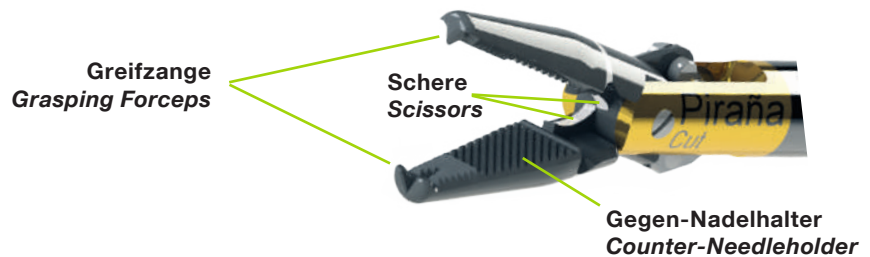

Ein Instrument – drei Funktionen: One instrument - three functions:



Schere

Die eingebaute Schere dient zum Durchtrennen des Nahtmaterials.
Empfohlene Nahtmaterialien:

Monofile Fäden 0-2/0 Geflochtene, resorbierbare Fäden 0-2/0.

Scissors

The built-in scissors are used to cut the suture material.

Recommended suture materials:

Monofilament threads 0-2/0 Braided, absorbable threads 0-2/0.



Gegen-Nadelhalter

Das feine Maulprofil erlaubt ein Fassen und Halten der Nadel und dient als Assistenz zum laparoskopischen Nadelhalter.

Counter-Needleholder

The fine jaw profile allows the needle to be grasped and held.
It serves as an assistant to the laparoscopic needle holder.



Greifzange

Die chirurgische Zahnung mit 1:2 Zähnen erlaubt ein sicheres Fassen von Gewebe und Netzimplantat.

Grasping Forceps

The surgical 1:2 teeth allow secure grasping of tissue and mesh implant.

Präparier- und Faszangen Dissecting and Grasping Forceps



Griff, allein
Handle, only



Mauleinsatz, allein
Jaw insert, only



Set Nummer = Instrument besteht aus Handgriff + Rohrschaft + Einsatz
Set Number = Instrument consists of Handle + Tube + Insert

Faszange, Alligator, doppelbeweglich, Ø 10 mm
Grasping forceps, Alligator, double action, Ø 10 mm

330 mm	RS000-901	RS119-901	RS129-901	RS139-901	RS219-901	RS229-901
--------	-----------	-----------	-----------	-----------	-----------	-----------

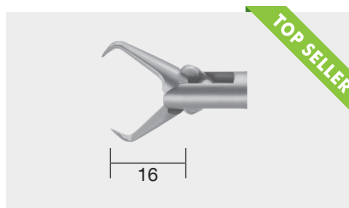

Hakenzange, doppelbeweglich, Ø 10 mm
Hook forceps, double action, Ø 10 mm

330 mm	RS000-948	RS119-948	RS129-948	RS139-948	RS219-948	RS229-948
--------	-----------	-----------	-----------	-----------	-----------	-----------

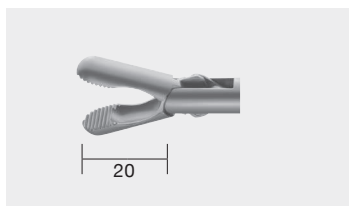

Faszange mit Löffel, doppelbeweglich, Ø 10 mm
Grasping forceps with spoon, double action, Ø 10 mm

330 mm	RS000-921	RS119-921	RS129-921	RS139-921	RS219-921	RS229-921
--------	-----------	-----------	-----------	-----------	-----------	-----------

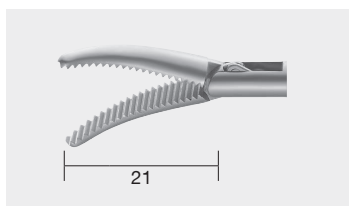

Präparier- und Faszange, Maryland, doppelbeweglich, Ø 10 mm
Dissecting and grasping forceps, Maryland, double action, Ø 10 mm

330 mm	RS000-912	RS119-912	RS129-912	RS139-912	RS219-912	RS229-912
--------	-----------	-----------	-----------	-----------	-----------	-----------

Präparier- und Fassungszangen Dissecting and Grasping Forceps



Griff, allein
Handle, only

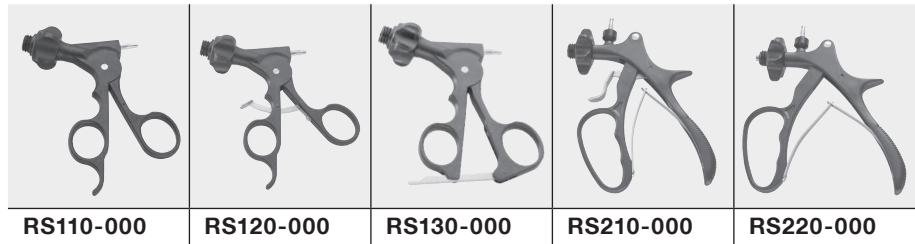

Mauleinsatz, allein
Jaw insert, only

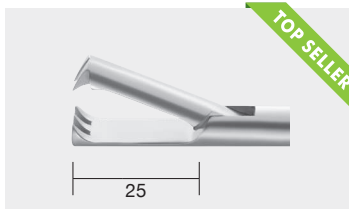

330 mm | **RS000-905**

Set Nummer = Instrument besteht aus Handgriff + Rohrschaft + Einsatz
Set Number = Instrument consists of Handle + Tube + Insert

Krallengreifer, 2x3 Zähne, einfach beweglich, Ø 10 mm
Claw grasping forceps, 2x3 teeth, single action, Ø 10 mm

RS119-905 | **RS129-905** | **RS139-905** | **RS219-905** | **RS229-905**

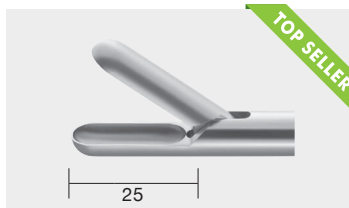

330 mm | **RS000-908**

Löffelzange, einfach beweglich, Ø 10 mm
Spoon forceps, single action, Ø 10 mm

RS119-908 | **RS129-908** | **RS139-908** | **RS219-908** | **RS229-908**

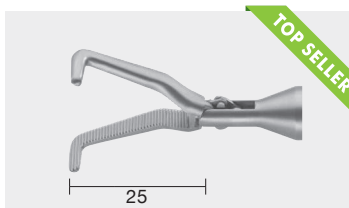

330 mm | **RS000-914**

Präparier- und Fassungzange, Mixer, doppelbeweglich, Ø 10 mm
Dissecting and grasping forceps, Mixer, double action, Ø 10 mm

RS119-914 | **RS129-914** | **RS139-914** | **RS219-914** | **RS229-914**

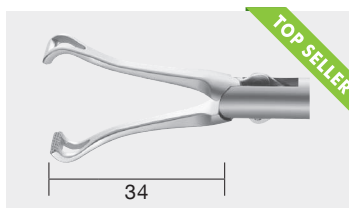

330 mm | **RS000-934**

Fassungzange, Babcock, doppelbeweglich, Ø 10 mm
Grasping forceps, Babcock, double action, Ø 10 mm

RS119-934 | **RS129-934** | **RS139-934** | **RS219-934** | **RS229-934**

Präparier- und Faszangen Dissecting and Grasping Forceps



Griff, allein
Handle, only



Mauleinsatz, allein
Jaw insert, only

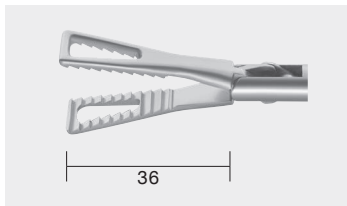

Set Nummer = Instrument besteht aus Handgriff + Rohrschaft + Einsatz
Set Number = Instrument consists of Handle + Tube + Insert

Fasszange, Pennington-Alligator, gerieft, doppelbeweglich, Ø 10 mm
Grasping forceps, Pennington-Alligator, grooved, double action, Ø 10 mm

330 mm | **RS000-930**

RS119-930 | **RS129-930** | **RS139-930** | **RS219-930** | **RS229-930**

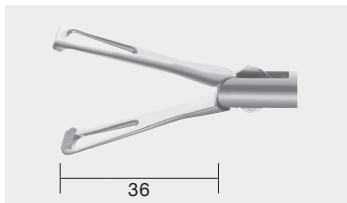

Fasszange, Duval, doppelbeweglich, Ø 10 mm
Grasping forceps, Duval, double action, Ø 10 mm

330 mm | **RS000-932**

RS119-932 | **RS129-932** | **RS139-932** | **RS219-932** | **RS229-932**

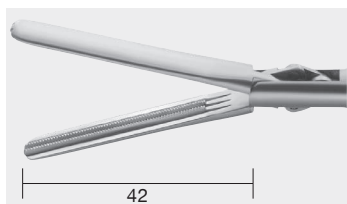

Fasszange, DeBakey, doppelbeweglich, Ø 10 mm
Grasping forceps, DeBakey, double action, Ø 10 mm

330 mm | **RS000-941**

RS119-941 | **RS129-941** | **RS139-941** | **RS219-941** | **RS229-941**

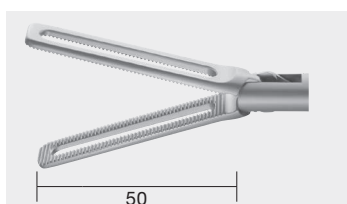

Fasszange, Dorsey, doppelbeweglich, Ø 10 mm
Grasping forceps, Dorsey, double action, Ø 10 mm

330 mm | **RS000-954**

RS119-954 | **RS129-954** | **RS139-954** | **RS219-954** | **RS229-954**

Präparier- und Faszangen Dissecting and Grasping Forceps



Griff, allein
Handle, only



Mauleinsatz, allein
Jaw insert, only

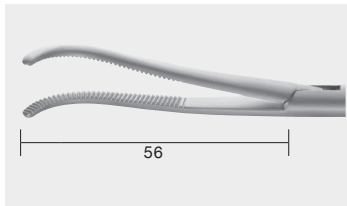

Set Nummer = Instrument besteht aus Handgriff + Rohrschaft + Einsatz
Set Number = Instrument consists of Handle + Tube + Insert

Präparier- und Faszange, lang, gebogen, einfach beweglich, Ø 10 mm
Dissecting and grasping forceps, long, curved, single action, Ø 10 mm

330 mm	RS000-918	RS119-918	RS129-918	RS139-918	RS219-918	RS229-918
--------	-----------	-----------	-----------	-----------	-----------	-----------

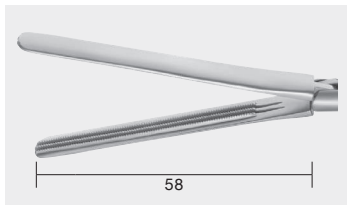

Faszange, DeBakey, doppelbeweglich, Ø 10 mm
Grasping forceps, DeBakey, double action, Ø 10 mm

330 mm	RS000-943	RS119-943	RS129-943	RS139-943	RS219-943	RS229-943
--------	-----------	-----------	-----------	-----------	-----------	-----------

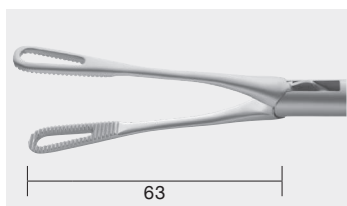

Faszange, oval, gefenestert, fein gerieft, doppelbeweglich, Ø 10 mm
Grasping forceps, oval, fenestrated, fine grooving, double action, Ø 10 mm

330 mm	RS000-923	RS119-923	RS129-923	RS139-923	RS219-923	RS229-923
--------	-----------	-----------	-----------	-----------	-----------	-----------

Index

Alphabetischer Index, Nummern Index
Alphabetical Index, Numerical Index
IN1 – IN8

Search



01

Veres-Kanülen
Veres Cannulas
LP1 - LP3



02

Optiken
Optics
LP5 - LP10



03

Trokare und Zubehör
Trocars and Accessories
LP11 - LP29



04

Screw-In Instrumente
Screw-In Instruments
LP31 - LP56



05

Saug- und Spülinstrumente
Suction and Irrigation
LP57 - LP61



06

HF Monopolar
HF Monopolar
LP63 - LP69

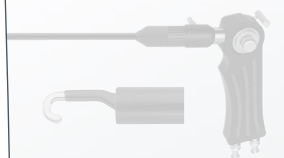

07

HF Bipolar
HF Bipolar
LP71 - LP76



08

Naht- und Clipanlegeinstrumente
Suturing / Clip Appliers
LP77 - LP85

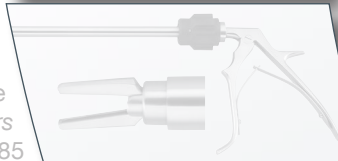

09

Diverse Laparoskopie-Instrumente
Various Laparoscopy Instruments
LP85 - LP93

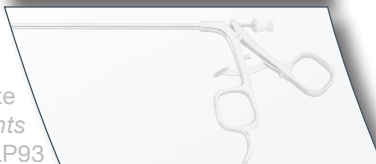

10

Zubehör
Accessories
LP95 - LP100

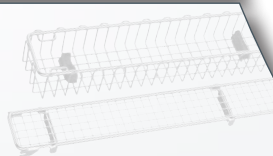

ZK 583-02 EN

Gerätecatalog
Devices Catalogue
LP101

RUDOLF



Endoscopy Devices
Endoscopy Devices

Saug-Spülrohr-Systeme Suction-Irrigation Tube Systems



Saug-Spülrohr mit Schiebeventil und Schlauchanschluss
Suction-Irrigation tube with sliding valve and tubing connection

Bestell-Nr. Ordering no.	Durchmesser Diameter	Nutzlänge Working length	Distales Ende Distal end
LP310-021	5 mm	330 mm	

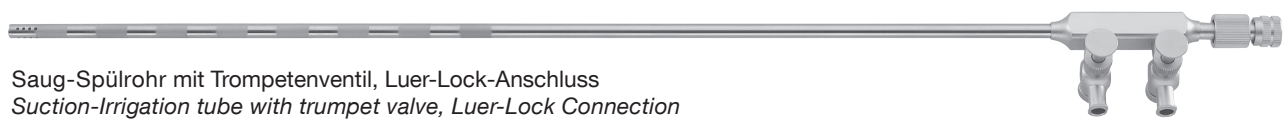



Saug-Spülrohr mit Trompetenventil, Luer-Lock-Anschluss
Suction-Irrigation tube with trumpet valve, Luer-Lock Connection

Bestell-Nr. Ordering no.	Optional Optional	Durchmesser Diameter	Nutzlänge Working length	Distales Ende Distal end
LP310-031	mit Laserführung with laser guiding	5 mm	340 mm	
LP310-032	ohne Laserführung without laser guiding			

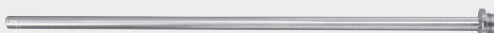

Saug-/Spülhandgriff mit Trompetenventil und Schlauchanschluss
Suction-irrigation handle with trumpet valve and tubing connection

Bestell-Nr. Ordering no.	Bemerkung Remarks	Ø Rohr Ø tube	Nutzlänge Working length	Distales Ende Distal end
LP310-200	komplett complete	5 + 10 mm	330 mm	
LP310-205	Griff allein Handle only			
LP310-201	Rohr allein Tube only	5 mm	330 mm	
LP310-202	Rohr allein Tube only	10 mm	330 mm	

Saug-Spülrohr-Systeme Suction-Irrigation Tube Systems





Bestell-Nr. Ordering no.	Griff-Varianten Handle types	
LP310-501	Griff allein, mit Trompetenventil und Luer-Lock-Anschluss Handle only, with trumpet valve and Luer-Lock Connection	
LP310-502	Griff allein, mit Trompetenventil und Schlauchanschluss Handle only, with trumpet valve and tubing connection	
LP310-503	Griff allein, mit Schiebeventil und Schlauchanschluss Handle only, with sliding valve and tubing connection	

Bestell-Nr. Ordering no.	Bohrungen Holes	Durchmesser Diameter	Nutzlänge Working length	Rohr-Varianten für die Griffe LP310-501 bis LP310-503 Tube types for the handles LP310-501 to LP310-503	
LP310-510	4	5 mm	330 mm	Standard Rundlochsauger Standard suction tube	
LP310-511	4	5 mm	500 mm		
LP310-518	16	5 mm	330 mm		
LP310-512	48	330 mm	Rundloch-Bienenkorbsauger Suction tube		
LP310-513	48	5 mm	330 mm	Stumpfer Bienenkorbsauger Blunt suction tube	
LP310-514	48	5 mm	500 mm		
LP310-517	12	5 mm	330 mm	Stumpfer Sauger Blunt suction tube	
LP310-516	—	5 mm	330 mm	Aqua Dissektions-Kanüle Aqua dissector cannula	
LP310-515	—	5 mm	330 mm	Punktionsnadelsauger Punction needle suction tube	

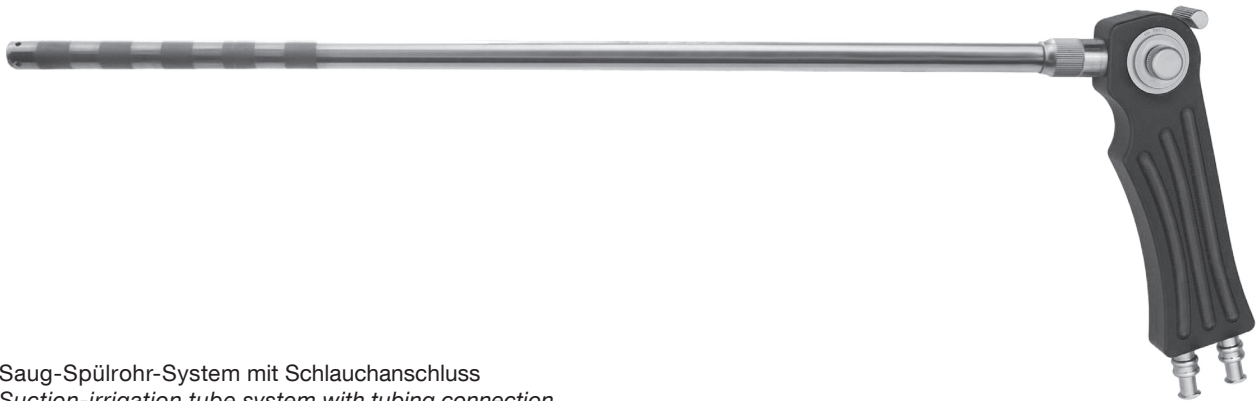
Saug-Spülrohr-Systeme Suction-Irrigation Tube Systems



Saug-Spülrohr-System mit Schlauchanschluss
Suction-irrigation tube system with tubing connection

Bestell-Nr. Ordering no.	Bemerkung Remarks	Ø Ø	Nutzlänge Working length	Rohr-Varianten für die Griffe LP310-501 bis LP310-503 Tube types for the handles LP310-501 to LP310-503
LP312-100	Griff allein Handle only		-	Pistolengriff mit Schiebeventil Pistol handle with sliding valve 
LP312-125	Rohr allein Tube only	5 mm	340 mm	Rohr Tube 
LP312-105	komplett mit Rohr complete with tube	5 mm	340 mm	
LP312-130	Rohr allein Tube only	10 mm	340 mm	
LP312-110	komplett mit Rohr complete with tube	10 mm	340 mm	
LP312-140	Kanüle allein Cannula only	5 mm	330 mm	Punktionskanüle Punction cannula 
LP312-115	komplett mit Punktionskanüle complete with punction cannula	5 mm	330 mm	



Index

Alphabetischer Index, Nummern Index
Alphabetical Index, Numerical Index
IN1 – IN8

Search



01

Veres-Kanülen
Veres Cannulas
LP1 - LP3



02

Optiken
Optics
LP5 - LP10



03

Trokare und Zubehör
Trocars and Accessories
LP11 - LP29



04

Screw-In Instrumente
Screw-In Instruments
LP31 - LP56



05

Saug- und Spülinstrumente
Suction and Irrigation
LP57 - LP61

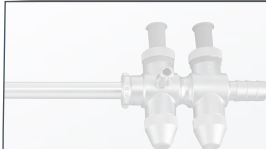

06

HF Monopolar
HF Monopolar
LP63 - LP69

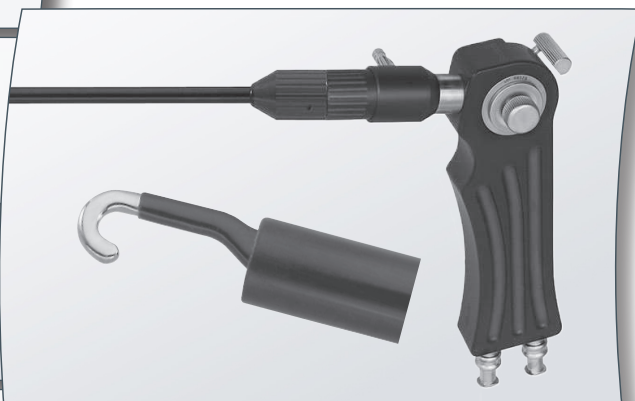

07

HF Bipolar
HF Bipolar
LP71 - LP76



08

Naht- und Clipanlegeinstrumente
Suturing / Clip Applicators
LP77 - LP85

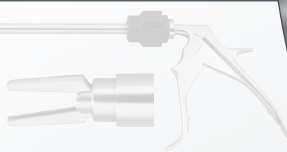

09

Diverse Laparoskopie-Instrumente
Various Laparoscopy Instruments
LP85 - LP93

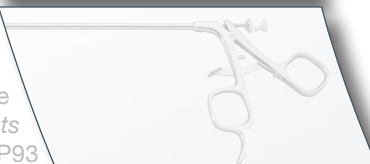

10

Zubehör
Accessories
LP95 - LP100

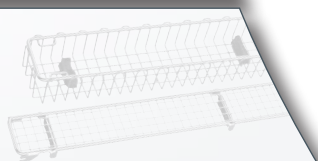

ZK 583-02 EN

Gerätekatalog
Devices Catalogue
LP101

RUDOLF



Endoscopy Devices
RUDOLF



Elektroden mit Saug-Spülrohr Electrodes with Suction-Irrigation



Saug-Spül-Systeme mit auswechselbaren HF-Elektroden, monopolar
Suction-Irrigation Tube Systems with interchangeable HF Electrodes, monopolar



Bestell-Nr. Ordering no.	
LP313-100	<p>Pistolengriff, allein, mit Schlauchanschluss</p> <p><i>Pistol handle, only, with tubing connection</i></p> 



Bestell-Nr. Ordering no.	Ø Ø	Nutzlänge Working length	Elektroden Electrodes
LP313-111	5 mm	340 mm	Haken-Elektrode <i>Hook electrode</i> 
LP313-112	5 mm	340 mm	Winkel-Elektrode <i>Right angle electrode</i> 
LP313-113	10 mm	340 mm	Spatel-Elektrode <i>Spatula electrode</i> 





Luer-Lock-Anschluss, mit Saugkanal, monopolar
Luer-Lock connection, with suction channel, monopolar

Bestell-Nr. Ordering no.	Ø Ø	Nutzlänge Working length	Elektroden Electrodes
LP320-312	5 mm	330 mm	Winkel-Elektrode Right angle electrode 
LP320-314	5 mm	330 mm	Knopf-Elektrode Ballpoint electrode 
LP320-317	5 mm	330 mm	Nadel-Elektrode Needle electrode 



NEW





Elektroden mit hochtemperaturfester **Keramikspitze**, monopolar
Electrode with high temperature resistant **ceramic tip**, monopolar

Bestell-Nr. Ordering no.	Ø Ø	Nutzlänge Working length	Elektroden Electrodes
LP320-111	5 mm	360 mm	J-Haken Elektrode J-Hook electrode 
LP320-112	5 mm	360 mm	L-Haken Elektrode L-Hook electrode 
LP320-113	5 mm	360 mm	Spatel-Elektrode Spatula electrode 



Bestell-Nr. Ordering no.	Ø Ø	Nutzlänge Working length	Elektroden Electrodes
LP320-082	2,8 mm	250 mm	Winkel-Elektrode Right angle electrode 



Bestell-Nr. Ordering no.	Ø Ø	Nutzlänge Working length	Elektroden Electrodes
LP320-061	5 mm	330 mm	Haken-Elektrode Hook electrode 
LP320-071	5 mm	450 mm	
LP320-062	5 mm	330 mm	Winkel-Elektrode Right Angle electrode 
LP320-072	5 mm	450 mm	
LP320-063	5 mm	330 mm	Spatel-Elektrode Spatula electrode 
LP320-073	5 mm	450 mm	
LP320-064	5 mm	330 mm	Knopf-Elektrode Ballpoint electrode 
LP320-074	5 mm	450 mm	

Bestell-Nr. Ordering no.	Griff, allein Handle, only
LP320-050	Zur Verwendung mit Elektroden LP320-061 bis LP320-074 To be used with electrodes LP320-061 to LP320-074 

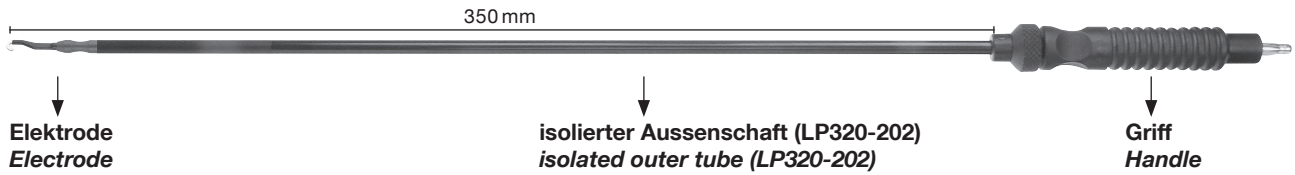

Handgriff inkl. Spannschaft und Elektrode mit auswechselbaren Spitzen
Handle incl. shaft and electrode with exchangeable tips



Handgriff inkl. Spannschaft
Handle incl. shaft

Bestell-Nr. Ordering no.	Ø Ø	
LP320-200	5 mm	

Zur Verwendung mit
To be used with

Bestell-Nr. Ordering no.	Ø Ø	Elektroden Electrodes	
LP320-220	5 mm	Winkel-Elektrode, wechselbar Right Angel-Electrode, exchangeable	
LP320-240	5 mm	Nadel-Elektrode, wechselbar Needle-Electrode, exchangeable	
LP320-250	4 mm	Kugel-Elektrode, wechselbar Ball-Electrode, exchangeable	

Sicherheitskabel, monopolar

Safety Cables, monopolar



Bestell-Nr. Ordering no.	Länge Length	Bezeichnung Description
HF300-151	3,5 m	<p>4 mm Geräteseite Anschlusskabel mit Sicherheitshülse für RUDOLF/Berchtold/Martin und Erbe T-Geräte <i>4 mm Unit side connection cable with safety Sleeve for RUDOLF/Berchtold/Martin and Erbe T units</i></p>
HF300-152	3,5 m	<p>5 mm Geräteseite Anschlusskabel mit Sicherheitshülse für Erbe ACC/ICC-Geräte <i>5 mm Unit side connection cable with safety Sleeve for Erbe ACC/ICC units</i></p>
HF300-153	3,5 m	<p>Anschlusskabel mit Sicherheitshülse für Valleylab, Conmed, Bovie-Geräte <i>Cable with safety Sleeve for Valleylab, Conmed, Bovie units</i></p>
90-0333	3 m	<p>SDS-Anschlusskabel für Emed <i>SDS-Cable for Emed</i></p>
90-0335	5 m	



Index

Alphabetischer Index, Nummern Index
Alphabetical Index, Numerical Index
IN1 – IN8

Search



01

Veres-Kanülen
Veres Cannulas
LP1 - LP3



02

Optiken
Optics
LP5 - LP10



03

Trokare und Zubehör
Trocars and Accessories
LP11 - LP29



04

Screw-In Instrumente
Screw-In Instruments
LP31 - LP56



05

Saug- und Spülinstrumente
Suction and Irrigation
LP57 - LP61

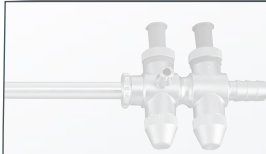

06

HF Monopolar
HF Monopolar
LP63 - LP69



07

HF Bipolar
HF Bipolar
LP71 - LP76



08

Naht- und Clipanlegeinstrumente
Suturing / Clip Appliers
LP77 - LP85

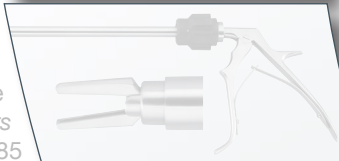

09

Diverse Laparoskopie-Instrumente
Various Laparoscopy Instruments
LP85 - LP93

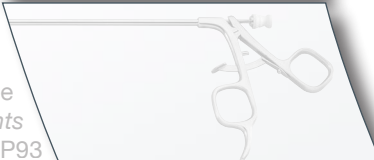

10

Zubehör
Accessories
LP95 - LP100

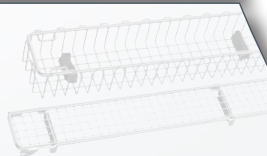

ZK 583-02 EN

Gerätekatalog
Devices Catalogue
LP101

RUDOLF



Endoscopy Devices
Endoscopy Devices

Standard Zangensystem Standard Forceps System



Griff, allein
Handle, only



LP440-000

Rohr allein, Nutzlänge 360 mm, Ø 5 mm
Tube only, working length 360 mm, Ø 5 mm



LP440-110

Einsatz, allein
Insert, only



360 mm Ø 5 mm | **LP440-001**

Set Nummer = Instrument besteht aus Griff + Rohr + Einsatz
Set Number = Instrument consists of Handle + Tube + Insert

Elektrode, gewellter Steg
Electrode, waved strip

LP440-111

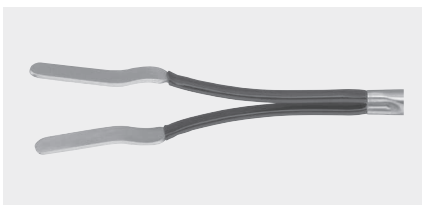

360 mm Ø 5 mm | **LP440-003**

Elektrode, Zange, 3mm
Electrode, Forceps, 3mm

LP440-113



Griff, allein
Handle, only



LP450-000

Rohr allein, Nutzlänge 340 mm, Ø 5 mm
Tube only, working length 340 mm, Ø 5 mm



LP450-110

Einsatz, allein
Insert, only

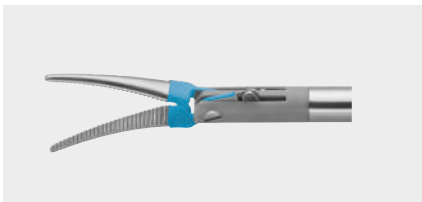

340 mm Ø 5 mm | LP450-001

Set Nummer = Instrument besteht aus Griff + Rohr + Einsatz
Set Number = Instrument consist of Handle + Tube + Insert

Dissektor Maryland, gebogen
Dissector Maryland, curved

LP450-111

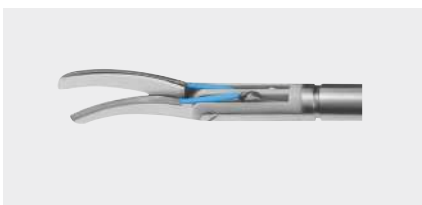

340 mm Ø 5 mm | LP450-002

Bipolare Koagulationsschere
Bipolar coagulation scissors

LP450-112

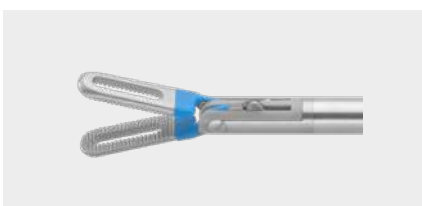

340 mm Ø 5 mm | LP450-003

Grosse Fasszange
Large grasping forceps

LP450-113



Griff, allein
Handle, only



LP450-000

Rohr allein, Nutzlänge 340 mm, Ø 5 mm
Tube only, working length 340 mm, Ø 5 mm



LP450-110

Einsatz, allein
Insert, only

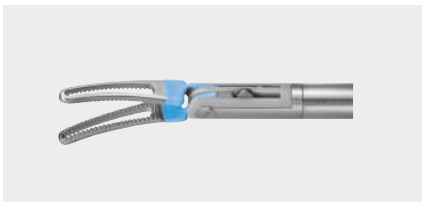

340 mm Ø 5 mm | LP450-004

Set Nummer = Instrument besteht aus Griff + Rohr + Einsatz
Set Number = Instrument consist of Handle + Tube + Insert

Bipolare Fasszange, gebogen
Bipolar grasping forceps, curved

LP450-114

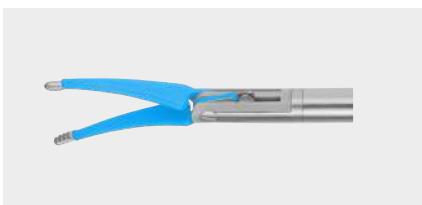

340 mm Ø 5 mm | LP450-005

Bipolare Pinzette, gebogen
Bipolar forceps, curved







LP450-115



340 mm Ø 5 mm | LP450-006

Bipolare Zange micro
Bipolar grasper micro

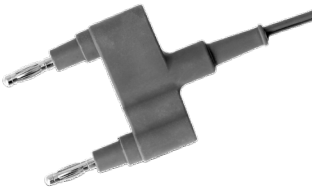
LP450-116

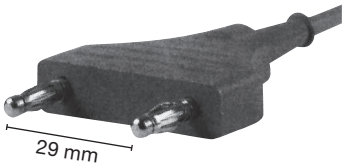
		Flachstecker <i>Flat plug</i>		2-Pin Stecker US-Standard <i>2-pin plug US-Standard</i>
				
		Instrumentenseite <i>Instrument side</i>		
Geräteseite <i>Generator side</i>	Länge <i>Length</i>		Länge <i>Length</i>	
 Steg biegsam / <i>flexible joint</i>	4 m	HF310-104	4 m	HF310-3031
 Erbe	3 m	HF310-113	–	–
 Martin, Berchtold, Aesculap	3 m	HF310-123	–	–
	5 m	HF310-125	–	–
 Valleylab, Lamidey, EMC 29 mm	3 m	HF310-133	3 m	HF310-333
	5 m	HF310-135	–	–

Index

Alphabetischer Index, Nummern Index
Alphabetical Index, Numerical Index
IN1 – IN8

Search



01

Veres-Kanülen
Veres Cannulas
LP1 - LP3



02

Optiken
Optics
LP5 - LP10



03

Trokare und Zubehör
Trocars and Accessories
LP11 - LP29



04

Screw-In Instrumente
Screw-In Instruments
LP31 - LP56



05

Saug- und Spülinstrumente
Suction and Irrigation
LP57 - LP61

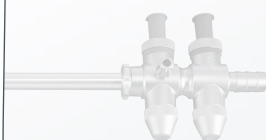

06

HF Monopolar
HF Monopolar
LP63 - LP69



07

HF Bipolar
HF Bipolar
LP71 - LP76



08

Naht- und Clipanlegeinstrumente
Suturing / Clip Applicators
LP77 - LP85

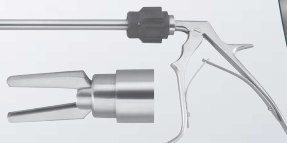

09

Diverse Laparoskopie-Instrumente
Various Laparoscopy Instruments
LP85 - LP93

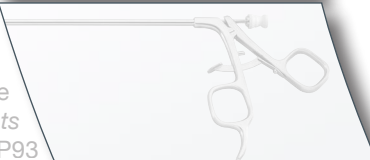

10

Zubehör
Accessories
LP95 - LP100

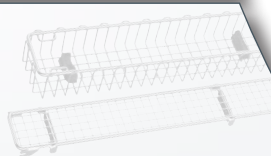

ZK 583-02 EN

Gerätekatalog
Devices Catalogue
LP101

RUDOLF



Endoscopy Devices
RUDOLF

Nähhilfen Suture Assisting Device



Applikator für Endo-Ligatur
Applicator for Endo Ligature

Bestell-Nr. Ordering no.	Aussen- / Innen Ø Outer / inner Ø	Nutzlänge Working length	Distales Ende Distal end
LP300-020	5–4 mm	180 mm	



Knotenführer
Knot guide

Bestell-Nr. Ordering no.	Durchmesser Diameter	Nutzlänge Working length	Distales Ende Distal end
LP315-501	4 mm	330 mm	
LP315-502	4,5 mm	330 mm	

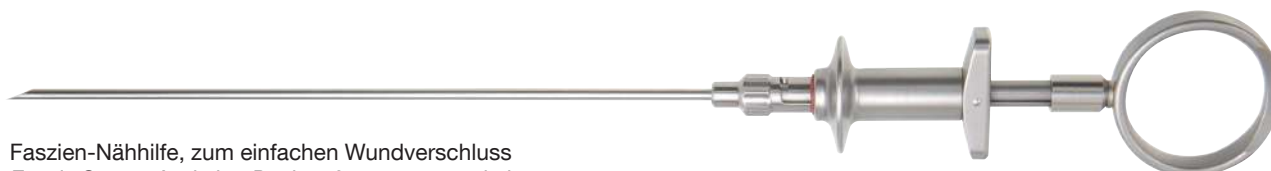

Faszien-Nähhilfe, zum einfachen Wundverschluss
Fascia Suture Assisting Device, for easy wound closure

Bestell-Nr. Ordering no.	Durchmesser Diameter	Nutzlänge Working length	Distales Ende Distal end
LP315-510	2.3 mm	140 mm	

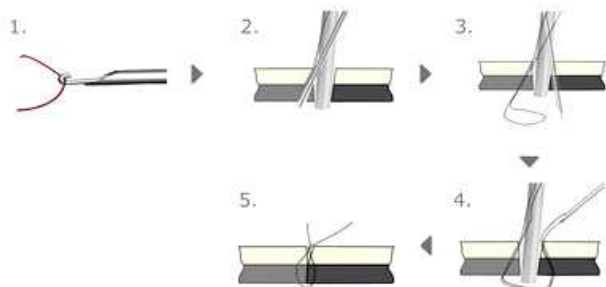

Die Faszien-Nähhilfe ist speziell für den einfachen Wundverschluss nach laparoskopischen Eingriffen mit einer Trokarrohr konzipiert und vereinfacht das Vernähen der Faszie erheblich. Das Design der Faszien-Nähhilfe ermöglicht ein einfaches Einfädeln und Repositionieren des Nahtmaterials mit Fadenfänger und Kanüle.

The fascial suture assisting device is specially designed for easy wound closure after laparoscopic procedures with a trocar tube and considerably simplifies suturing the fascia. The design of the fascial suturing aid allows easy threading and repositioning of the suture material with threaded catcher and cannula.

Nadelhalter, einteilig

Needle Holder, one-piece



Luer-Lock Anschluss für eine verbesserte
Reinigung der Innenlumen
*Luer-Lock connector for the improved
cleaning of the inner tube*



Ergonomisches und leichtes Griffdesign
Axiale Griffe - gebogen und gerade
*Ergonomic and lightweight handle
Axial handle - curved and straight*

Eingebauter Überlastschutz
Integrated overload protection

Stabiler und torsionsarmer Schaft
Stable and torsion-resistant shanks

Sperre mit einer feinen,
präzisen Arretierung
*Fine and precise
adjustment ratchet*



Modelle mit Hartmetall Einlagen
Models with TC hard metal inserts



Modelle mit Nadel selbstafrichtender Funktion
Models with needle self-righting function

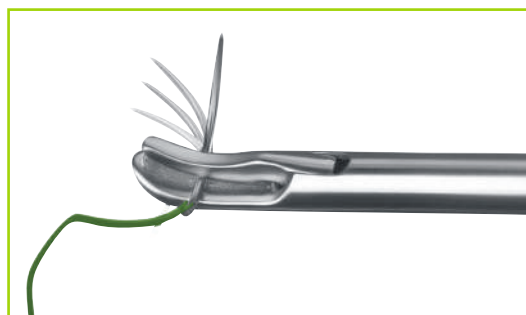

Nadelhalter, einteilig

Needle Holder, one-piece

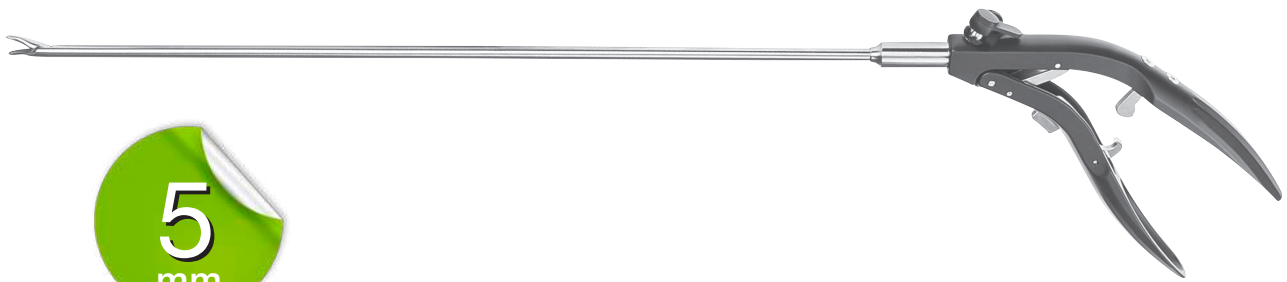

5
mm

1 Part Instruments

Distales Ende mit
Hartmetalleinlagen
*Distal end with
tungsten carbide inserts*





Leichtgewicht, gebogen
Light weight, curved

Leichtgewicht, gerade
Light weight, straight

Schweres Modell, gerade
Heavy weight, straight

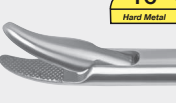

Nutzlänge
*Working
length*

  Gerade <i>Straight</i>	330 mm	LP354-033	LP353-033	LP352-021
	450 mm	LP354-045	LP353-045	-
  Links gebogen <i>Curved left</i>	330 mm	LP354-133	LP353-133	LP352-022
	450 mm	LP354-145	LP353-145	-
  Rechts gebogen <i>Curved right</i>	330 mm	LP354-233	LP353-233	LP352-023
	450 mm	LP354-245	LP353-245	-

Distales Ende mit beschichteten Maulinnenflächen
Distal end with coated inner jaws

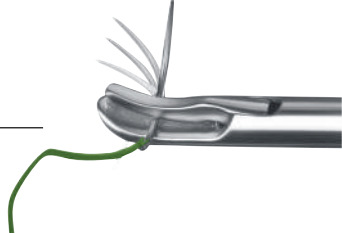
 Selbstaufrichtend <i>Self righting</i>	330 mm	LP354-330	LP353-330	
	450 mm	LP354-345	LP353-345	

Nadelhalter, dreiteilig Needle Holder, three-part



Einfache Montage
Easy assembly

Luer-Lock Anschluss für eine verbesserte
Reinigung der Innenlumen
*Luer-Lock connector for the improved
cleaning of the inner tube*

Überlastungsschutz
Overload protection

Stabile und verwindungssteife Schäfte
Stable and torsion-resistant shanks

Ergonomisches und leichtes Griffdesign
Axiale Griffe - gebogen und gerade
*Ergonomic and lightweight handle
Axial handle - curved and straight*

Handgriffe und Einsätze einfach kombinierbar
Simple combination of handles with inserts

SCHREW-IN

Modelle mit Hartmetall Einlagen
Models with TC hard metal inserts

SCHREW-IN

Modelle mit Nadel selbstaufrichtender Funktion
Models with needle self-righting function

Sperre mit einer feinen,
präzisen Arretierung
*Fine and precise
adjustment ratchet*

Nadelhalter, dreiteilig

Needle Holder, three-part



Griff, allein
Handle, only

Leichtgewicht, gebogen
Light weight, curved



LP356-000

Leichtgewicht, gerade
Light weight, straight



LP355-000

Schweres Modell, gerade
Heavy weight, straight

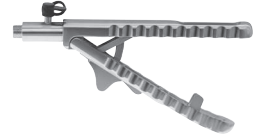

LP357-000

Rohre, allein
Tubes, only

330 mm	LP033-000
450 mm	LP045-000



Mauleinsatz, allein
Jaw insert, only

Set Nummer = Instrument besteht aus Handgriff + Rohrschaft + Einsatz
Set Number = Instrument consists of Handle + Tube + Insert



Distales Ende mit Hartmetall-Einlage, gerade, Ø 5 mm
Distal end with tungsten carbide inserts, straight, Ø 5 mm

330 mm	LP000-033
450 mm	LP000-045

LP356-033	LP355-033	LP357-033
LP356-045	LP355-045	LP357-045

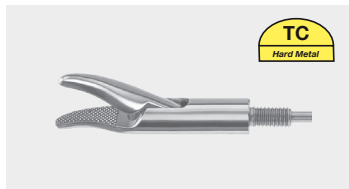

Distales Ende mit Hartmetall-Einlage, links gebogen, Ø 5 mm
Distal end with tungsten carbide inserts, curved left, Ø 5 mm

330 mm	LP000-133
450 mm	LP000-145

LP356-133	LP355-133	LP357-133
LP356-145	LP355-145	LP357-145

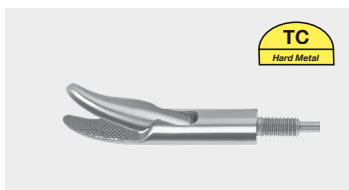

Distales Ende mit Hartmetall-Einlage, rechts gebogen, Ø 5 mm
Distal end with tungsten carbide inserts, curved right, Ø 5 mm

330 mm	LP000-233
450 mm	LP000-245

LP356-233	LP355-233	LP357-233
LP356-245	LP355-245	LP357-245



Distales Ende mit beschichteter Maulinnenseite, selbstaufrichtend, Ø 5 mm
Distal end with coated inner jaws, self righting, Ø 5 mm

330 mm	LP000-330
450 mm	LP000-345

LP356-330	LP355-330	LP357-330
LP356-345	LP355-345	LP357-345

Clip-Anlegezangen Clip-Applying Forceps

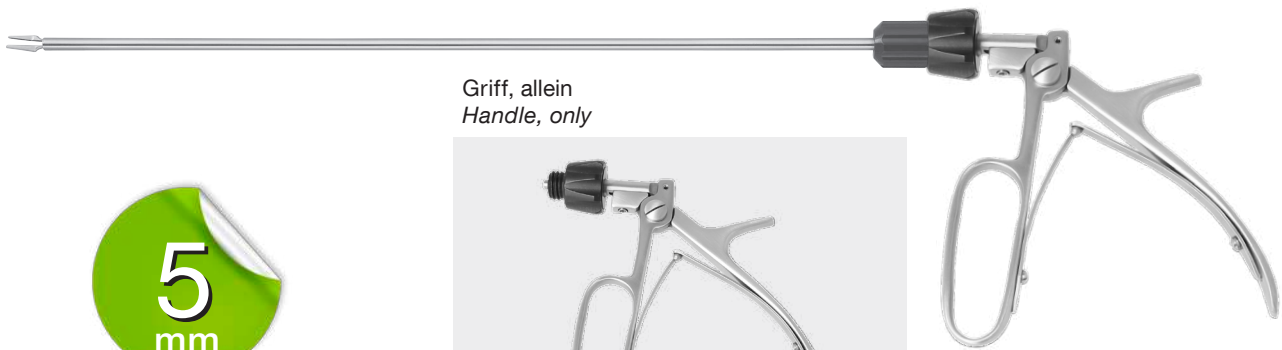

Griff, allein
Handle, only



LP372-100

Rohr allein, Nutzlänge 330 mm, Ø 5 mm
Tube only, working length 330 mm, Ø 5 mm



LP372-101



Mauleinsatz, allein
Jaw insert, only



330 mm Ø 5 mm | **LP372-010**

Set Nummer = Instrument besteht aus Handgriff + Rohrschaft + Einsatz
Set Number = Instrument consists of Handle + Tube + Insert

Zange für Ethicon Clips, klein, Maulbreite 5,5 mm
Forceps for ethicon clips, small, jaw width 5,5 mm

LP372-001

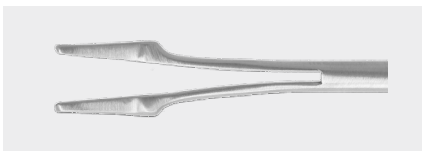

330 mm Ø 5 mm | **LP372-020**

Zange für Ethicon Clips, mittel, Maulbreite 6,5 mm
Forceps for ethicon clips, medium, jaw width 6,5 mm

LP372-002

Ethicon Ligaturclips für Clip-Anlegezangen Ethicon ligature clips for clip applying forceps



Bestell-Nr. Ordering no.	Clipgröße Clip size	Kennfarbe Colour code	Verpackungseinheit Packing unit
LP371-210	klein small	blau blue	36 Magazine mit je 6 Clips 36 Magazines with 6 clips each
LP371-211			15 Magazine mit je 20 Clips 15 Magazines with 20 clips each
LP371-212	mittel medium	weiß white	36 Magazine mit je 6 Clips 36 Magazines with 6 clips each
LP371-213			15 Magazine mit je 20 Clips 15 Magazines with 20 clips each
LP371-214	mittelgroß medium-large	grün green	18 Magazine mit je 6 Clips 18 Magazines with 6 clips each
LP371-215	groß large	gelb yellow	18 Magazine mit je 6 Clips 18 Magazines with 6 clips each

Clip-Anlegezangen Clip-Applying Forceps

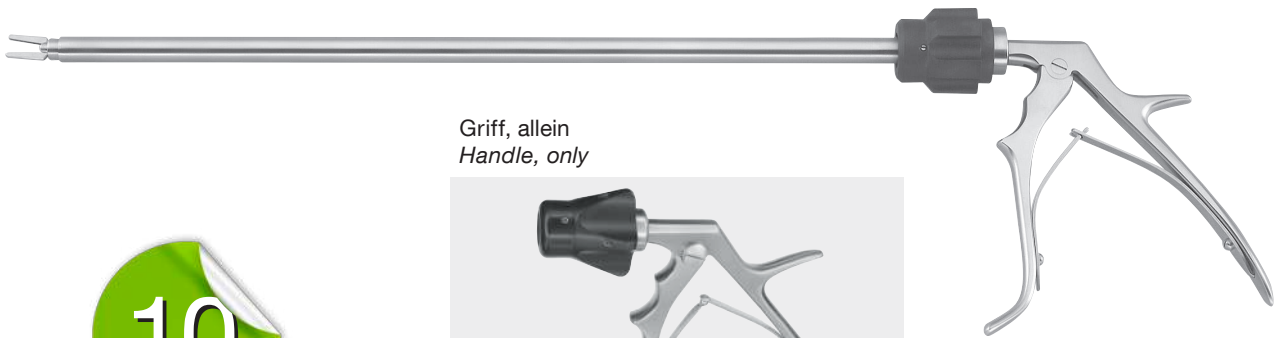

10
mm

Griff, allein
Handle, only



LP371-100

Rohr allein, Nutzlänge 330 mm, Ø 10 mm
Tube only, working length 330 mm, Ø 10 mm



LP371-101

Mauleinsatz, allein
Jaw insert, only

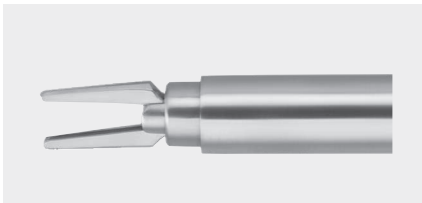

330 mm Ø 10 mm | **LP371-010**

Set Nummer = Instrument besteht aus Handgriff + Rohrschaft + Einsatz
Set Number = Instrument consists of Handle + Tube + Insert

LP371-001

Zange für Ethicon Clips, mittel, zerlegbar, drehbar
Forceps for ethicon clips, medium, detachable, rotatable

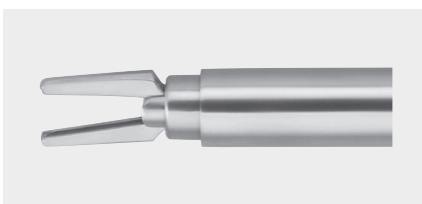

330 mm Ø 10 mm | **LP371-020**

LP371-002

Zange für Ethicon Clips, mittelgroß, zerlegbar, drehbar
Forceps for ethicon clips, medium-large, detachable, rotatable

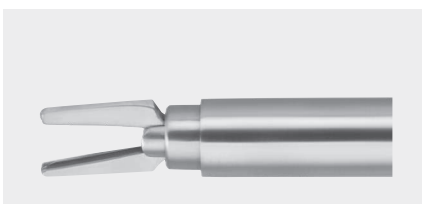

330 mm Ø 10 mm | **LP371-030**

LP371-003

Zange für Ethicon Clips, groß, zerlegbar, drehbar
Forceps for ethicon clips, large, detachable, rotatable



Index

Alphabetischer Index, Nummern Index
Alphabetical Index, Numerical Index
IN1 – IN8

Search



01

Veres-Kanülen
Veres Cannulas
LP1 - LP3



02

Optiken
Optics
LP5 - LP10



03

Trokare und Zubehör
Trocars and Accessories
LP11 - LP29



04

Screw-In Instrumente
Screw-In Instruments
LP31 - LP56



05

Saug- und Spülinstrumente
Suction and Irrigation
LP57 - LP61

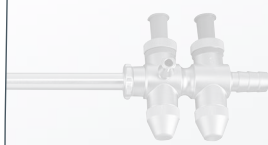

06

HF Monopolar
HF Monopolar
LP63 - LP69



07

HF Bipolar
HF Bipolar
LP71 - LP76



08

Naht- und Clipanlegeinstrumente
Suturing / Clip Appliers
LP77 - LP85

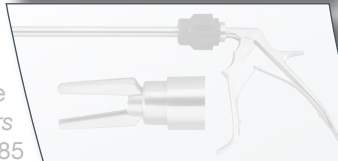

09

Diverse Laparoskopie-Instrumente
Various Laparoscopy Instruments
LP85 - LP93



10

Zubehör
Accessories
LP95 - LP100

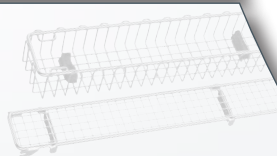

ZK 583-02 EN

Gerätekatalog
Devices Catalogue
LP101

RUDOLF



Endoscopy Devices
Endoscopy Devices

Diverse Laparoskopie-Instrumente

Various Laparoscopy Instruments



Taststab
Palpation probe

Bestell-Nr. Ordering no.	Durchmesser Diameter	Nutzlänge Working length	
LP315-111	5 mm	330 mm	
LP315-112	5 mm	400 mm	
LP315-113	5 mm	450 mm	



Injektions- und Punktionskanüle mit Luer-Lock-Anschluss
Injection and puncture needle with Luer-Lock Connection

Bestell-Nr. Ordering no.	Durchmesser Diameter	Nutzlänge Working length	
LP313-012	5 mm	330 mm	
LP313-013	5 mm	450 mm	

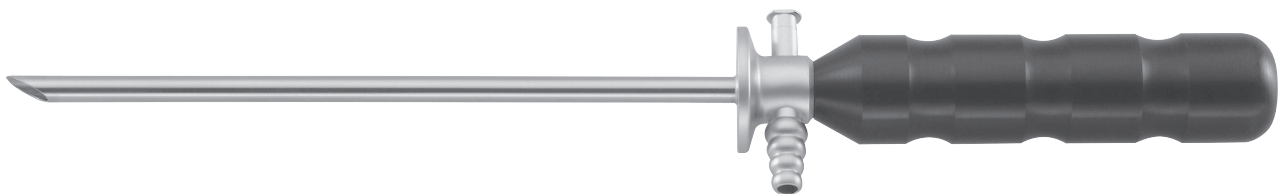

Einstichtrocar für sterile Lösung
Insertion trocar for sterile solution

Bestell-Nr. Ordering no.	Durchmesser Diameter	Für Flasche For bottle	Nutzlänge Working length	
LP314-002	6 mm	1.0l	235 mm	

Cholangiographie-Fixierzange, mit Sperre

Cholangiography Fixation Clamp, with Ratchet



5
mm

Cholangiographie-Fixierzange, mit Instrumentenkanal 7 Fr./Charr., zur Katheterplatzierung
Cholangiography Fixation Clamp, working channel 7 Fr./Charr., for catheter placement

Bestell-Nr. Ordering no.	Durchmesser Diameter	Nutzlänge Working length	Distales Ende Distal end
LP325-010	5 mm	330 mm	

Krallengreifer und Löffelzange

Claw Grasping and Spoon Forceps



10
mm

Krallengreifer und Löffelzange mit Spülkanal
Claw grasping and spoon forceps with irrigation channel

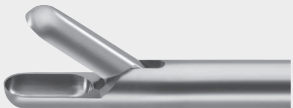
Bestell-Nr. Ordering no.	Durchmesser Diameter	Nutzlänge Working length	Distales Ende Distal end
LP325-025	10 mm	330 mm	Krallengreifer, 2 x 3 Zähne Claw grasping forceps, 2 x 3 teeth 
LP325-020	10 mm	330 mm	Löffelzange Spoon forceps 

Abdominal-Spekulum Abdominal Speculum



Abdominal-Spekulum zur Einstichverweiterung und zur Bergung von Organen

Bei der Entfernung der Gallenblase ist das Abdominal-Spekulum von großem Vorteil. Vor der Entfernung der Gallenblase wird das Abdominal-Spekulum zusammen mit der zentralen Trokarrohr in den Nabelbereich geschoben, bis es in der Bauchhöhle sichtbar wird. Anschließend wird die abgetrennte Gallenblase mit der Faszange in die Trokarrohr hineingezogen. Es wird dann das Abdominal-Spekulum maximal gespreizt und gleichzeitig die Trokarrohr gemeinsam mit der gefassten Gallenblase herausgezogen. Gelingt die totale Entfernung der Gallenblase nicht sofort vollständig, weil sich zu viele oder zu große Steine im Gallenblasen-Fundus befinden, können die Steine durch Spreizen des Spekulum wesentlich einfacher mit einer Steinfaßzange entfernt werden.

Abdominal Speculum for Incision Extension and Organ Extraction

The abdominal speculum is a real benefit for the removal of the gallbladder. Before removing the gallbladder the abdominal speculum is inserted together with the central trocar sheath into in the umbilical area until it becomes visible in the abdominal cavity. Then the detached gallbladder is pulled with a grasping forceps into the trocar sheath. The abdominal speculum is spread maximally and, at the same time, the trocar sheath and the grasped gallbladder are pulled out. In case the complete removal of the gallbladder is not successful, due to the great quantity or size of the stones situated in the gallbladder fundus, it is easier to remove the stones with a stone grasping forceps by spreading the abdominal speculum.



Abdominal-Spekulum Abdominal Speculum

Bestell-Nr. Ordering no.	Länge Length	Blattlänge Length of blade	Winkel Angle
LP323-205	250 mm	55 mm	90°

Leber-Elevatoren, dreiteilig Liver Elevators, three-part



Griff, allein
Handle, only

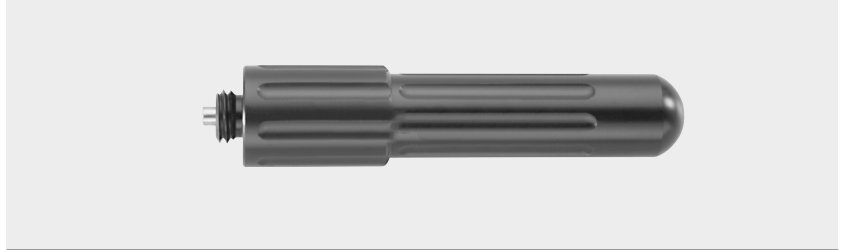

LP323-000

Rohre, allein
Tubes, only

355 mm, Ø 5 mm	RS005-000
390 mm, Ø 10 mm	RS009-000



Einsatz, allein
Insert, only

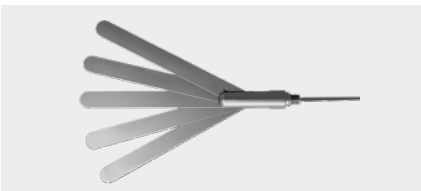

Set Number = Instrument besteht aus Handgriff + Rohr + Einsatz
Set Number = Instrument consist of Handle + Tube + Insert

Leber-Elevator
Liver Elevator

355 mm, Ø 5 mm	LP323-015
390 mm, Ø 10 mm	LP323-020

LP323-005
LP323-010

Abwinkelbarer Leber-Elevator, zweiteilig Deflectable Liver Elevator, two-part



Griff, allein
Handle, only



LP323-002

Einsatz, allein
Insert, only



Leber-Elevator, abwinkelbar
Liver Elevator, deflectable

Set Nummer = Instrument besteht aus Handgriff + Einsatz
Set Number = Instrument consists of Handle + Insert

330 mm, Ø 10 mm

LP323-040

LP323-035



Index

Alphabetischer Index, Nummern Index
Alphabetical Index, Numerical Index
IN1 – IN8

Search



01

Veres-Kanülen
Veres Cannulas
LP1 - LP3



02

Optiken
Optics
LP5 - LP10



03

Trokare und Zubehör
Trocars and Accessories
LP11 - LP29



04

Screw-In Instrumente
Screw-In Instruments
LP31 - LP56



05

Saug- und Spülinstrumente
Suction and Irrigation
LP57 - LP61

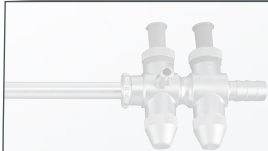

06

HF Monopolar
HF Monopolar
LP63 - LP69



07

HF Bipolar
HF Bipolar
LP71 - LP76



08

Naht- und Clipanlegeinstrumente
Suturing / Clip Applicators
LP77 - LP85

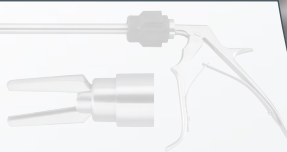

09

Diverse Laparoskopie-Instrumente
Various Laparoscopy Instruments
LP85 - LP93

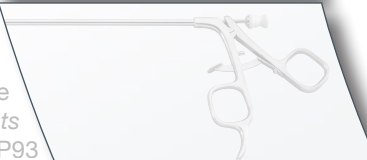

10

Zubehör
Accessories
LP95 - LP100

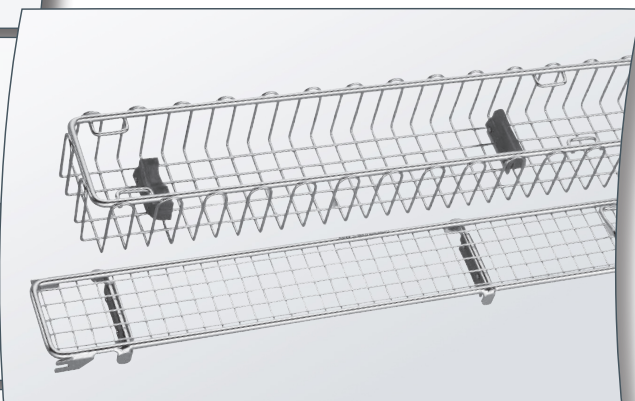
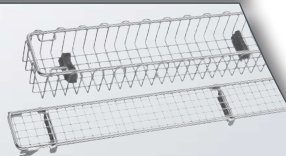

ZK 583-02 EN

Gerätekatalog
Devices Catalogue
LP101

RUDOLF



Endoscopy Devices
Endoscopy Devices



Reinigungsbürsten
Cleaning Brushes

Länge Length	Ø2,5 mm	Ø7 mm	Ø11 mm
380 mm	RU 8865-51	RU 8865-55	RU 8865-59
500 mm	RU 8865-52	RU 8865-56	RU 8865-60

Luer-lock-Schlauchverbinder
Luer-lock tubing connector

Bestell-Nr. Ordering no.	Bezeichnung Description
RU 5288-31	Luer-lock-Schlauchverbinder, mit Absperrhahn <i>Luer-lock tubing connector, with stopcock</i>



Sterilisations- und Aufbewahrungszubehör

Sterilizing and Storage Accessories

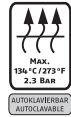

Bestell-Nr. Ordering no.	Bezeichnung Description
RZ010-000	Schutzhülse für Optiken bis Ø5 mm, Kunststoff <i>Protecting tube for optics up to Ø5.0 mm, plastic</i>
	Aufsteckbar für NL 300 mm, Ø5 mm, Kunststoff <i>Attachable for WL 300 mm, Ø5.0 mm, plastic</i>



Bestell-Nr. Ordering no.	Abmessungen (LxBxH) Dimensions (l x w x h)	Bezeichnung Description
RU8908-18	470 x 250 x 125 mm	Lagerungsgestell für bis zu 15 Instrumente, für 5 + 10 mm Instrumente <i>Storing rack for up to 15 instruments, for 5 + 10 mm instruments</i>

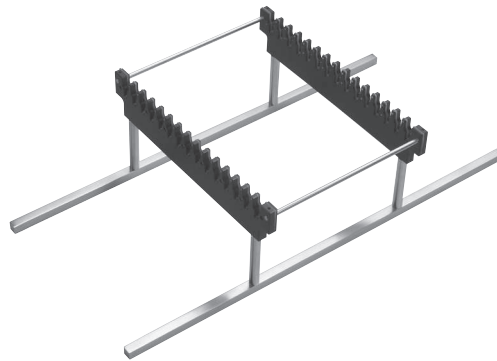

Bestell-Nr. Ordering no.	Abmessungen (LxBxH) Dimensions (l x w x h)	Bezeichnung Description
RU8908-13	464 x 190 x 70 mm	Kunststoffbehälter für bis zu 15 Instrumente, für 5 + 10 mm Instrumente <i>Plastic container for up to 15 instruments, for 5 + 10 mm instruments</i>

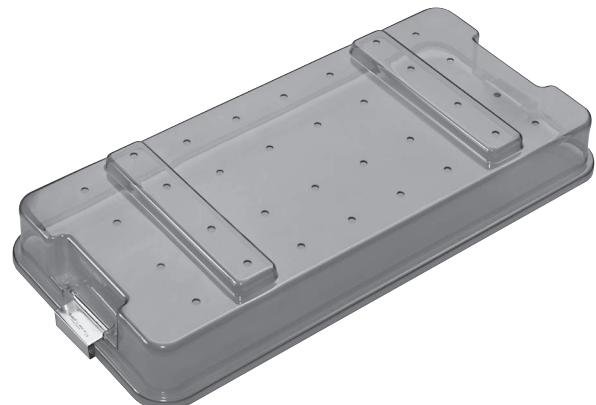
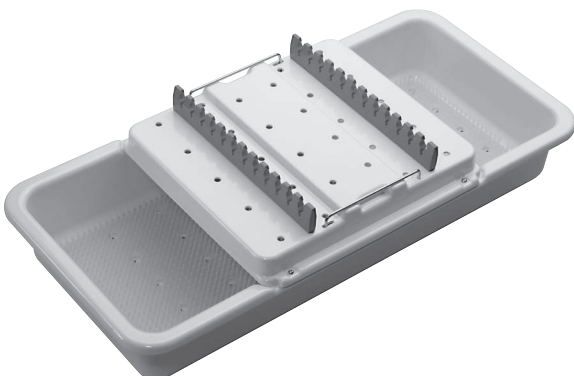



Sterilisations- und Aufbewahrungszubehör

Sterilizing and Storage Accessories

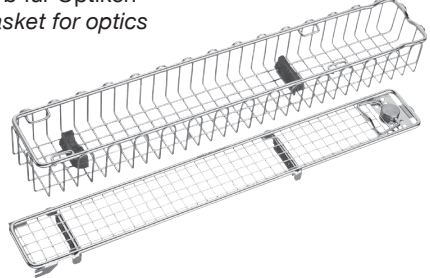

Siebkorb und Kunststoffbehälter
Wire Basket and plastic container

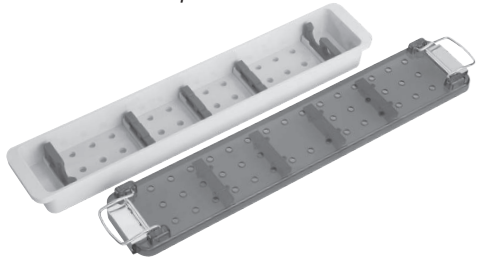
Bestell-Nr. Ordering no.	Abmessungen (LxBxH) Dimensions (l x w x h)	Für Optik - Ø mm For optics - Ø mm	
RU8908-01	290 x 80 x 52 mm	1 – 10 mm	<p>Siebkorb für Optiken Wire basket for optics</p> 
RU8908-11	460 x 80 x 52 mm	1 – 10 mm	
RU8908-02	670 x 80 x 52 mm	1 – 10 mm	
RU8930-00	275 x 70 x 35 mm	5 – 10 mm	<p>Kunststoffbehälter für Optik Plastic container for optics</p> 
RU8908-12	457 x 70 x 35 mm	5 – 10 mm	<p>Kunststoffbehälter für Optiken Plastic container for optics</p> 
RU8908-14	394 x 70 x 35 mm	5 – 10 mm	
RU8930-01	271 x 70 x 35 mm	1 – 10 mm	



Antibeslagmittel
für Endoskope

*Antifog solution
for endoscopes*

steril, 30 ml
sterile, 30 ml

RU 8880-05



Pflegefett
für Hähne

*Lubricant
for stopcocks*

40g
40g

RU 8880-50

Index

Alphabetischer Index, Nummern Index
Alphabetical Index, Numerical Index
IN1 – IN8

Search



01

Veres-Kanülen
Veres Cannulas
LP1 - LP3



02

Optiken
Optics
LP5 - LP10



03

Trokare und Zubehör
Trocars and Accessories
LP11 - LP29



04

Screw-In Instrumente
Screw-In Instruments
LP31 - LP56



05

Saug- und Spülinstrumente
Suction and Irrigation
LP57 - LP61

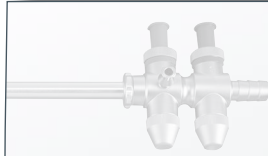

06

HF Monopolar
HF Monopolar
LP63 - LP69



07

HF Bipolar
HF Bipolar
LP71 - LP76



08

Naht- und Clipanlegeinstrumente
Suturing / Clip Appliers
LP77 - LP85

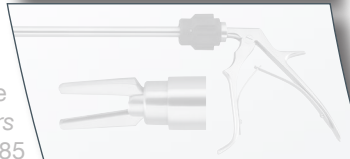

09

Diverse Laparoskopie-Instrumente
Various Laparoscopy Instruments
LP85 - LP93

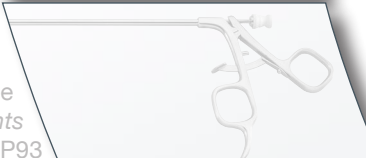

10

Zubehör
Accessories
LP95 - LP100

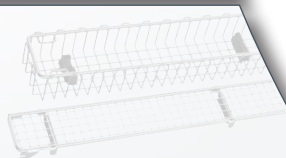

ZK 583-02 EN

Gerätekatalog
Devices Catalogue
LP101

RUDOLF
BECAUSE WE CARE



Endoscopy Devices

Brilliance in Endoscopy

RUDOLF
BECAUSE WE CARE



Endoscopy Devices

Brilliance in Endoscopy



RUDOLF Medical GmbH + Co. KG, weltweit vertreten, vertraut auf bleibende Werte und setzt diese durch enge Kundenbeziehungen um. RUDOLF Medical bietet innovative Hightech-Produkte, Handinstrumente, starre Endoskope sowie effiziente Serviceleistungen für zahlreiche chirurgische Fachgebiete an.

RUDOLF Medical GmbH + Co. KG, represented worldwide, translates its belief in lasting values by fostering close customer relationships and offering innovative high technology products, hand instruments, rigid endoscopes as well as efficient services for numerous surgical disciplines.



Vertrieb durch:
Distributed by:

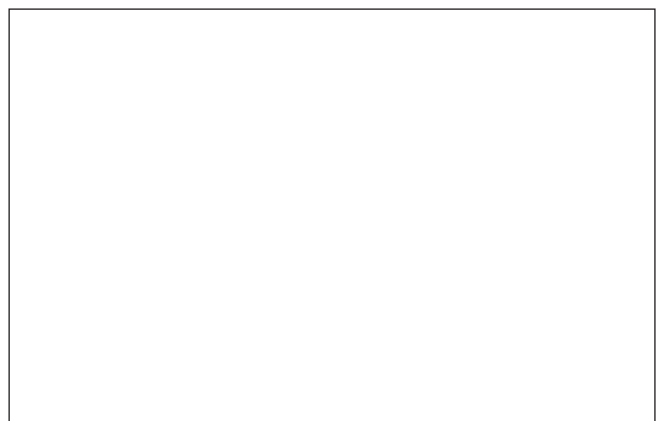

Vertrieb durch: RUDOLF Medical GmbH + Co. KG
Zollerstr. 1, 78567 Fridingen, Germany
Tel.: +49 7463 9956-0
sales@rudolf-med.com
www.rudolf-med.com
BECAUSE WE CARE



ZK 360-2B DE/EN_Rev. 03.2023

