



GENERAL SURGERY

RUDOLF
BECAUSE WE CARE



RUDOLF
BECAUSE WE CARE

Contents

Inhaltsverzeichnis

Chapter 1 – 12

Kapitel 1 – 12

Contents	Index	IN
Scissors	<i>Scheren</i>	SC 1
Scalpels and Knives	<i>Skalpelle und Messer</i>	SK 2
Forceps	<i>Pinzetten</i>	FC 3
Clamps and Forceps	<i>Klemmen und Zangen</i>	CF 4
Retractors	<i>Retraktoren</i>	RE 5
Trocars, Suction and Irrigation Instruments, Probes, Cotton Applicators	<i>Trokare, Saug- und Spülinstrumente, Sonden, Watteträger</i>	TS 6
Woundclosure	<i>Wundverschluß</i>	WO 7
Abdominal Surgery	<i>Abdominale Chirurgie</i>	AS 8
Gynecology and Obstetrics	<i>Gynäkologie und Geburtshilfe</i>	GO 9
Bone Surgery	<i>Knochenchirurgie</i>	BS 10
HF-Surgery	<i>HF-Chirurgie</i>	HF 11
Hygiene and Storage	<i>Hygiene und Aufbewahrung</i>	HS 12

Abbildungstreue und Haftung

- **RUDOLF** Medical behält sich Änderungen und Abweichungen von den im Katalog dargestellten Produkten und Abbildungen ausdrücklich vor
- Änderungen dienen ausschließlich der kontinuierlichen Verbesserung und Modellpflege der Produkte im Rahmen von Produktentwicklungen
- **RUDOLF** Medical kann die in den Katalogen enthaltenen Informationen ohne vorherige Ankündigung ändern

Urheberrecht, Warenzeichen und Patente

- Der Besteller darf die von uns vorgelegten Kataloge, Zeichnungen, Pläne, Abbildungen, Berechnungen, Preislisten, Muster, technische Unterlagen und das ihm überlassene Know-how nur dann an Dritte weitergeben oder ihnen bekanntmachen, wenn wir zuvor schriftlich zugestimmt haben. Etwaige Urheberrechte behalten wir uns ausdrücklich vor

Picture Fidelity and Liability Note

- **RUDOLF** Medical reserves expressly the right to alter and deviate from the products and product pictures presented in the catalogue
- Alterations serve exclusively the continuous improvement and model modification of the products for the purpose of product development
- **RUDOLF** Medical may alter the information contained in the catalogues without prior notice

Copyright, Trademark and Patents

- The buyer may only provide or make known to third parties the catalogues, drawings, plans, graphics, calculations, price lists, samples, technical documents and know-how provided to the buyer by us if we have granted our prior written permission for this. All copyright rights are expressly reserved by us



- Unsere **Instrumenten-Abbildungen** ohne Angabe eines Maßstabes haben eine Größe von **1:2**.
- Ausnahmen hiervon werden mit einer Maßstabangabe z. B. 1:3 gekennzeichnet.
- Unsere **Detailbilder** sind in **Originalgröße (1:1)** abgebildet.
- Ausnahmen hiervon werden mit einer Maßstabangabe z. B. 1:3 gekennzeichnet.



- All **instrument illustrations** without a scale indication show the instruments in **1:2**.
- Exceptions to this will be shown with a scale indication e.g. 1:3.
- All **detail drawings** are in **original size (1:1)**.
- Exceptions to this will be shown with a scale indication e.g. 1:3.



Unsere tabellarischen Anordnungen zeigen:



- An der Tabelle das komplette Instrument gemäß Maßstabsangabe von Seite GI
- Oberhalb der Tabelle die Detailbilder gemäß Maßstabsangabe von Seite GI, die in Fortführung der virtuellen Spalte platziert sind
- Die Symbole weisen auf die Materialeigenschaften und das Design der Schneiden hin

Our tabular presentations show:

- At the table the complete instrument according to the scale indicated on page GI
- Above the table the detail pictures, according to the scale indicated on page GI, placed in the continuation of the virtual column
- The symbols indicate the material properties and the blade design



METZENBAUM



gebogen
curved



stumpf / stumpf
blunt / blunt

gerade
straight



gebogen
curved

Typ / Type	13 cm – 5"	14,5 cm – 5¾"	
	RU 1311-13	RU 1301-14	RU 1311-14
MC	–	RU 1301-14M	RU 1311-14M
CC	–	RU 1301-14C	RU 1311-14C
TC	–	RU 1304-14	RU 1314-14
TC/MC	–	RU 1304-14M	RU 1314-14M
TC/CC	–	RU 1304-14C	RU 1314-14C

Lebensdauer Service Life / Durability

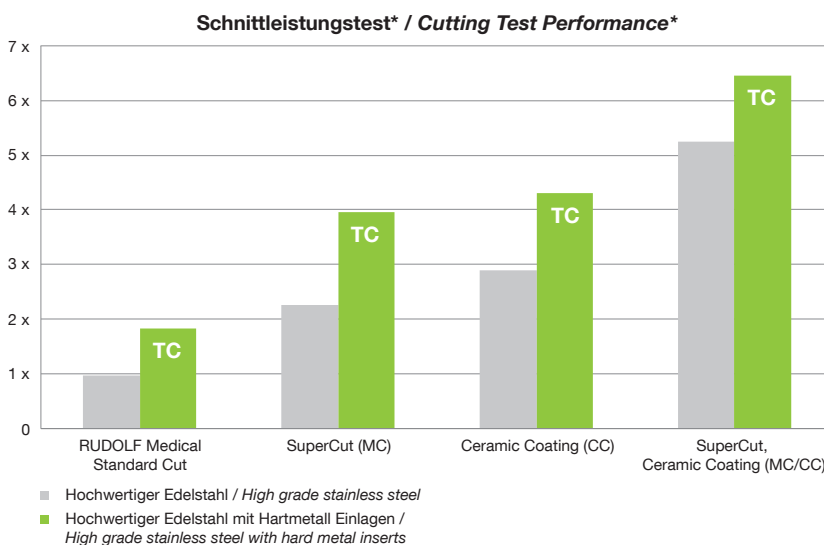

*nach DIN 58298:2010-09, Abschnitt B4-Schneidefähigkeit von Scheren
*according to DIN 58298:2010-09, article B4-cutting efficiency of scissors



Chapter Assignment

SC = Scissors	1
SK = Scalpels and Knives	2
FC = Forceps	3
CF = Clamps and Forceps	4
RE = Retractors	5
TS = Trocars, Suction and Irrigation Instruments, Probes, Cotton Application	6
WO = Woundclosure	7
AS = Abdominal Surgery	8
GO = Gynecology and Obstetrics	9
BS = Bone Surgery	10
HF = HF-Surgery	11
HS = Hygiene and Storage	12

Kapitel Zuordnung

SC = Scheren	1
SK = Skalpelle und Messer	2
FC = Pinzetten	3
CF = Klemmen und Zangen	4
RE = Retraktoren	5
TS = Trokare, Saug- und Spülinstrumente, Sonden, Watteträger	6
WO = Wundverschluß	7
AS = Abdominale Chirurgie	8
GO = Gynäkologie und Geburtshilfe	9
BS = Knochenchirurgie	10
HF = HF-Chirurgie	11
HS = Hygiene und Aufbewahrung	12

INDEX



A

Abdominal retractors.....RE50–64
 Accessories.....HS 14, HS 15
Adson
 Needle holders WO 14
Adson
 Bone rongeur forceps BS50
 Cannulas..... TS5
 Delicate tissue forceps..... FC25–27
 Hemostatic forceps CF20
 Micro suture forceps FC2
 Pituitary forceps FC21
 Raspatories..... BS20
 Retractors RE46, RE47
 Self-retaining retractors.....
 RE43, RE44
Adson–Brown
 Skin forceps..... FC37
Adson–Ewald
 Delicate tissue forceps..... FC26
Adson–Graefe
 Skin forceps..... FC37
Adson Standard
 Delicate dissecting forceps..... FC11
Alderdyce
 Elevators BS27
Alexander
 Chisels BS2
 Gouges BS2
 Raspatories..... BS19
 Uterine biopsy forceps GO52
Allen
 Stomach clamps..... AS14
Allis
 Intestinal and tissue grasping forceps
 AS1
Allis–Adair
 Intestinal and tissue grasping forceps
 AS2
Allis–Atrauma
 Intestinal and tissue grasping forceps
 AS2
Alm
 Self-retaining retractors..... RE31
 Amniotome for the pampniotic membrane
 GO28
 Amputation knives SK8
 Amputation retractor BS41
 Anal retractor AS22
 Anastomosis clamps..... AS17
Anderson–Adson
 Self-retaining retractors..... RE43
Andrew–Pyncheon
 Cannulas..... TS3
 Anoscopes AS23
 Appendectomy clamp AS14
 Applying forceps..... 59
 Atraumatic forceps FC22
Austin
 Micro suture forceps FC2
 Autopsy knives SK9
Auvard
 Vaginal specula..... GO20

B

Babcock
 Intestinal and tissue grasping forceps
 AS4
Babcock–Atrauma
 Intestinal and tissue grasping forceps
 AS4
Baby–Adson
 Hemostatic forceps CF20
Baby–Allis
 Intestinal and tissue grasping forceps
 AS1
Baby–Balfour
 Abdominal retractors..... RE56
Baby–Collin
 Abdominal retractors..... RE50
Baby–Crile
 Hemostatic forceps CF8
Baby–Crile–Wood
 Needle holders WO26
Baby–Doyen
 Intestinal clamps..... AS7
Baby–Kocher
 Intestinal clamps..... AS11
Baby–Lexer (Knapp)
 Facelift and nasal scissors SC37
Baby–Metzenbaum
 Dissecting scissors..... SC31
Baby–Mikulicz
 Peritoneal forceps CF42
Baby–Mixer
 Ligature forceps CF34
Baby–Olsen–Hegar
 Needle holders WO15
Baby–Overholt
 Ligature forceps CF27
Baby–Roux
 Retractors RE11
Baby–Senn–Mueller
 Retractors RE10
Baby–Tischler
 Biopsy forceps..... GO51
Backhaus
 Towel forceps 46
Bainbridge
 Hemostatic forceps CF19
Bakes
 Gall duct dilators AS33
Balfour
 Abdominal retractors..... RE56–58
Balfour USA pattern
 Abdominal retractors..... RE58
Ballentine
 Hysterectomy forceps GO41
 Bandage scissors SC71–74
Bane–Hartmann
 Bone rongeur forceps BS45
Barnes–Neville
 Obstetrical forceps..... GO65
Baron
 Cannulas..... TS7
Barr
 Rectal specula..... AS21
Barraquer
 Micro Needle holders..... WO8, WO9

Barraquer
 Razor blades holder SK6
 Suture forceps..... FC42
Barraquer–Troutman
 Micro needle holders WO8
Barrett
 Placenta forceps..... GO67
 Uterine tenaculum forceps..... GO26
Barsky
 Fine wound retractors RE2
 Baskets full size..... HS11
 Baskets half size..... HS9
 Baskets mini size..... HS12
 Baskets, mini size..... HS13
 Baskets, three-quarter size..... HS10
 Battery, rechargeable, for oscillating
 plaster saw WO57
Beacham
 Amniotome GO28
Beckmann–Adson
 Self-retaining retractors..... RE45
Beckmann–Adson (standard)
 Retractors RE46
Beckmann–Eaton
 Retractors RE47
 Bed pans HS2
Beebee
 Crown Scissors SC67
Beer
 Cilia forceps..... FC42
Bengolea
 Hemostatic forceps CF21
Bennett
 Bone levers BS31
Benson
 Pylorus spreader AS14
Berger
 Biopsy forceps..... GO49
Bergmann
 Bandage scissors SC73
 Mallets BS79, BS80
 Wound retractors..... RE5
Bernhard
 Towel forceps 48
Beyer
 Bone rongeur forceps
 BS47, BS51
Biemer
 Vein scissors..... SC8
 Biopsy and aspirating curettes... GO58
 Biopsy curettes GO45
 Biopsy forceps GO46–51
 Biopsy instruments GO37, GO44
 Bipolar Connecting Cables
 for bipolar forceps 2–pin plug... HF18
 for bipolar forceps flat plug..... HF18
 Bipolar connecting cables for scissors
 HF6
 Bipolar forceps HF7–17
 Bipolar forceps, general information....
 HF7
 Bipolar Forceps, NON–STICK.. HF7–14
 Bipolar Forceps, standard..... HF7–15
 Bipolar forceps, tungsten carbide.....
 HF16, HF17
 Bipolar scissors SC46, HF5, HF6



General information.....	SC46	Brodie	Rectal probe.....	TS 16	Catheter forceps.....	TS 10
Bipolar scissors, general information...	HF5	Brophy	Delicate dissecting forceps.....	FC 17	Catheter guide.....	AS 42
			Delicate tissue forceps.....	FC 31	Cerclage instruments.....	BS 78
Bircher-Ganske		Brophy (Sullivan)	Delicate surgical scissors.....	SC 17	Chaput	
Bone holding forceps.....	BS 37	Brown	Needle holders.....	WO 10	Hemostatic forceps.....	CF 13
Birkett			Skin forceps.....	FC 37	Charrière	
Hemostatic forceps.....	CF 22	Brunner	Guiding probes.....	WO 47, WO 48	Saws.....	BS 62
Bladder neck spreader.....	AS 40		Retractors.....	RE 24, RE 28	Cheatle	
Bladder retractors.....	AS 37, AS 38		Sigmoid anastomosis clamps.....	AS 19	Sterilization forceps.....	HS 1
Blades.....	SK 1–SK 5	Bruns			Cheron	
Blake			Bandage scissors.....	SC 74	Cotton swab forceps.....	54
Uterine curettes.....	GO 57		Bone curettes.....	BS 9, BS 10	Child	
Blepharoplasty scissors.....	SC 37	Bryant	Dressing and polypus forceps.....	CF 51	Wound suture forceps.....	WO 51
Blount					Chisels.....	BS 1–3, BS 5
Bone levers.....	BS 31	Buck	Cotton applicators.....	TS 18	Chisel, set.....	BS 1
Blumenthal					Cilia forceps.....	FC 42
Bone rongeur forceps.....	BS 48	Buck-Gramcko	Bone levers.....	BS 28	Circumcision instruments.....	AS 42
Boehler					Clamp forceps.....	CF 40, CF 41
Extension bows.....	BS 77	Buie	Clamp forceps.....	CF 40	Clamp holder.....	AS 17
Bone cutting forceps.....	BS 57		Fistula probes.....	TS 16	Cleveland	
Bone rongeur forceps.....	BS 50	Bulldog clamps		CF 58–61	Bone rongeur forceps.....	BS 46
Boettcher		Bunt	Sterilization clamps.....	HS 1	Clip applying and removing forceps....	WO 51
Tonsil scissors.....	SC 57				Clip applying forceps.....	WO 52
Bone curettes.....	BS 9–BS 14, BS 15	Burke	Uterine biopsy forceps.....	GO 52	Clip forceps.....	WO 51
Bone cutting forceps.....	BS 57–59	Busch	Umbilical scissors.....	SC 64	Closing forceps.....	AS 17
Bone holding forceps.....	BS 36–44	C			Cloward	
Bone Levers.....	BS 28–31	Cairns	Hemostatic forceps.....	CF 16	Self-retaining retractors.....	RE 37
Bone rasps.....	BS 16		Cannulas.....	TS 3–7	Wound retractors.....	RE 3
Bone retractors.....	BS 32, BS 34	Canny-Ryall	Retractors.....	RE 19	Cobb	
Bone rongeur forceps.....	BS 45–56		Carabiner.....	HS 14	Gouges.....	BS 8
Bone scissors.....	SC 75	Caroll	Tendon seizing forceps.....	BS 86	Raspatories.....	BS 22–24
Bone wire.....	BS 78	Carrel	Hemostatic forceps.....	CF 13	Coller-Crile	
Bone wire guides.....	BS 78		Case for oscillating plaster saws.....	WO 57	Hemostatic forceps.....	CF 9
Bone wire tighteners.....	BS 78	Caspar	Mini-scalpel handle.....	SK 1	Collin	
Bonney			Retractors.....	RE 17	Abdominal retractors.....	RE 50–52
Polypus and ovary forceps.....	GO 33	Castanares	Dissecting scissors.....	SC 42	Clip applying and removing forceps....	WO 51
Dissecting forceps.....	FC 20	Castroviejo	Micro needle holders.....	WO 6, WO 7	Cotton swab forceps.....	54
Tissue forceps.....	FC 36		Corneal scissors.....	SC 8	Hemostatic forceps.....	CF 15
Bonn Pattern			Razor blade holder.....	SK 5	Retractors.....	RE 13
Delicate dissecting scissors.....	SC 23		Razor blade holder, swiss pattern.....	SK 5	Rib shears.....	SC 76
Boys-Allis					Tissue grasping forceps.....	AS 5
Intestinal and tissue grasping forceps	AS 2	Castroviejo / Barraquer	Micro Needle Holders.....	WO 6	Tongue holding forceps.....	57
			Micro needle holders.....	WO 9	Umbilical cord clamp.....	GO 62
bozemann		Castroviejo-Kalt			Uterine elevating forceps.....	GO 35
Needle Holders.....	WO 21				Vaginal specula.....	GO 1
Bozemann					Collin-Duval	
Cotton swab forceps.....	CF 54, CF 55				Intestinal and lung forceps.....	FC 38
Bozemann-Douglas					Collin-Pozzi	
Cotton swab forceps.....	55				Uterine tenaculum forceps.....	GO 27
Braun					Combination wrench.....	BS 77
Delicate dissecting forceps.....	FC 13				Cone	
Delicate tissue forceps.....	FC 29				Self-retaining retractors.....	RE 44
Brand					Cone (Adson-Baby)	
Tendon seizing forceps.....	BS 85				Self-retaining retractors.....	RE 41
Braun					Connecting cables.....	HF 18
Uterine depressor.....	GO 24				Converse	
Uterine tenaculum forceps.....	GO 27, GO 29				Needle holders.....	WO 29
					Cooley	
Vaginal specula.....	GO 14				Retractors.....	RE 29
Braun-Stadler					Cooper	
Perineum (Episiotomy) scissors.....	SC 65				Ligature needles.....	WO 43
Breisky					Corneal scissors.....	SC 8
Vaginal specula.....	GO 18				Cottle	
Bristow					Chisels.....	BS 3
Bone levers.....	BS 31					



Fixing forceps.....	FC23	Delicate dissecting forceps.....	FC 11–18	Vaginal specula.....	GO 15–17
Mallets.....	BS83	Delicate dissecting scissors.....	SC 22–25	Doyen-Atrauma	
Nasal scissors.....	SC48	Delicate scissors.....	SC 11–15	Intestinal clamps.....	AS 8
Osteotomes.....	BS3	Delicate surgical scissors.....	SC 16, SC 17	Doyen-Stille	
Raspatories.....	BS20	Delicate tissue forceps.....	FC 25–28, FC 30–32	Retractors.....	RE23
Skin forceps.....	FC37	De Martel (Willet)		Drape clamps.....	HS 15
Cottle-Jansen		Scalp flap forceps.....	GO 61	Drape retainer for wire basket.....	HS 9–12
Bone rongeur forceps.....	BS 48	De Martel-Wolfson		Dratigues	
Cotton applicators.....	TS 18–20	Anastomosis clamps.....	AS 17	Uterine elevating forceps.....	GO 35
Cotton dispensers.....	HS 4	Clamp holder.....	AS 17	Dressing and polypus forceps.....	51
Cotton swab forceps.....	54, 55	Closing forceps.....	AS 17	Dressing forceps.....	CF 51–53
Crafoord		Demel		Drills.....	BS 63–65
Hemostatic forceps.....	CF 25	Bone wire guides.....	BS 78	Drill wires.....	BS 67–69
Crile		Denis-Brown		Dunhill	
Fine wound retractors.....	RE 1	Abdominal retractors.....	RE 61	Hemostatic forceps.....	CF 15
Hemostatic forceps.....	CF 8	Derf		Duplay	
Retractors.....	RE 8	Needle holders.....	WO 10, WO 20	Uterine tenaculum forceps.....	GO 27
Crile-Murray		Dermatomes.....	SK 10	Durante	
Needle Holders.....	WO 14	Deschamps		Grasping forceps.....	FC 39
Crile-Rankin		Ligature needles.....	WO 39–41	Dust extractor.....	WO 58
Hemostatic forceps.....	CF 8	Deschamps-Standard		Duval	
Crile-Wood		Ligature needles.....	WO 38	Intestinal and lung forceps.....	FC 38
Needle holders.....	WO 14, WO 26–28	Desjardins.....	AS 32, AS 33	Tissue grasping forceps.....	AS 5, AS 6
Crown scissors.....	SC 67	Desmarres		E	
Curettes.....	BS 9–15	Retractors.....	RE 8	Ear dressing forceps.....	FC 23, FC 24
Cusco		Dieffenbach		Ear probe.....	TS 16
Vaginal specula.....	GO 2, GO 3	Bulldog clamps.....	CF 58	Elevating spoon.....	GO 61
Cushing		Diétrich		Elevators.....	BS 25–27
Cutter.....	BS 63	Bulldog clamps.....	CF 60, 61	Emmet	
Decompression hooks.....	RE 9	Dingmann		Cotton swab forceps.....	54
Delicate dissecting forceps.....	FC 16	Bone holding forceps.....	BS 36	Enderectomy scissors.....	SC 49
Delicate tissue forceps.....	FC 30	Dingmann (modif.)		Endospecula for cervix.....	GO 23
Fine wound retractors.....	RE 1	Bone holding forceps.....	BS 36	Engel	
Raspatories.....	BS 18	Directors.....	TS 15, TS 16	Plaster saw.....	WO 55
Retractors.....	RE 7	Dissecting forceps.....	FC 19–21, CF 35	Engl. Pattern	
Cushing-Taylor		Dissecting forceps, standard.....	FC 19	Towel forceps.....	45
Delicate dissecting forceps.....	FC 16	Dissecting knives with metal handle.....	SK 7	Enterotomy scissors.....	SC 58
Cutter.....	BS 76	Dissecting micro forceps.....	FC 5–7	Eppendorf	
Czerny		Dissecting scissors.....	SC 22–36, SC 38–44	Biopsy forceps.....	GO 50
Rectal specula.....	AS 20	Dissecting scissors.....	SC 45	Errico	
Uterine tenaculum forceps.....	GO 28	General information.....	SC 45	Cutter.....	BS 63
D		Dissecting scissors with suture hole.....	SC 60	Esmarch	
Dandy		Dixon-Lovelace		Bandage scissors.....	SC 73
Hemostatic forceps.....	CF 18	Hemostatic forceps.....	CF 19	Plaster knives.....	WO 55
Daubenspeck		Douay		Ewald	
Bone curettes.....	BS 12	Biopsy forceps.....	GO 50	Delicate dissecting forceps.....	FC 11
Davidson		Double-ended probes.....	TS 14	Extension bows.....	BS 77
Retractors.....	RE 29	Double spiral holder.....	HS 15	Eye scissors.....	SC 11
Dean		Douglas		F	
Gum scissors.....	SC 68	Cilia forceps.....	FC 42	Facelift and nasal scissors.....	SC 37
Deaver		Doyen		Farabeuf	
Retractors.....	RE 24, RE 25	Probe, curved.....	TS 15	Raspatories.....	BS 17
Surgical scissors.....	SC 20	Abdominal retractors.....	RE 63	Retractors.....	RE 12
De Bakey		Gynecological scissors.....	SC 62	Farabeuf-Lambotte	
Needle holders.....	WO 25	Intestinal clamps.....	AS 7	Bone holding forceps.....	BS 41
Atraumatic forceps.....	FC 22	Myoma screw.....	GO 37	Farrell	
Vascular scissors.....	SC 50	Ovary forceps.....	GO 36	Cotton applicators.....	TS 20
Self-retaining retractors.....	RE 49	Raspatories.....	BS 21	Faure	
De Bakey-Hess		Retractors.....	RE 22	Biopsy forceps.....	GO 48
Bulldog clamps.....	59	Vaginal retractors.....	GO 19	Clamp forceps.....	CF 41
Decompression hooks.....	RE 9				
De Lee					
Polypus and ovary forceps.....	GO 33				



Peritoneal forceps CF 44
 Feet (Plastic), for wire basket.....
HS9–12
Fehland
 Sigmoid anastomosis clamps
 AS 19
Feilchenfeld
 Splinter forceps FC 40
Fein
 Cotton applicators..... TS 18
Fergusson
 Bone holding forceps.....BS38
 Cannulas..... TS 4, TS 5
 Haemorrhoidal forceps AS 26
Ferris-Smith
 Tissue forceps FC 35
 Fine wound retractors..... RE 1, RE 2
 Finger ring saw..... BS 61
Fino
 Delicate scissors SC 15
 Iris and suture scissors..... SC 11
 Iris and suture scissors..... SC 11
Finocchietto
 Needle holders WO 13, WO 34
 Ligature forceps CF 37
Finsen
 Self-retaining retractors..... RE 31
Fish
 Probes TS 14
 Self-retaining retractors RE 35
 Fistula hook..... GO 37
 Fistula probes TS 16, TS 17
 Fistula scissors..... SC 62
 Fixation clamps..... HS 15
 Fixing forceps FC 23
 Flat nosed pliers.... BS 60, BS 70, BS 73
Foerster-Ballenger
 Sponge holding forceps..... 56
Fomon
 Nasal scissors..... SC 48
Fomon-Saber-Back
 Nasal scissors..... SC 47
Ford Dixon
 Haemorrhoidal Ligators..... AS 30
 Foreign body forceps AS 43
Franz
 Abdominal retractors..... RE 63
Frazier
 Abdominal retractors..... RE 55
 Cannulas..... TS 5
 Micro suction tubes..... TS 9
Frazier (Fergusson)
 Cannulas..... TS 4
Freeman
 Dissecting scissors..... SC 44
Freeman-Gorney
 Dissecting scissors..... SC 41
Freeman-Kaye
 Dissecting scissors..... SC 40
Friedmann-Delikat
 Bone rongeur forceps BS 46
Fritsch
 Retractors RE 22
Frohn
 Cotton applicators..... TS 20
Fuchsig
 Hemostatic forceps CF 20

G
 Gall duct forceps CF 32, AS 31
 Gall duct instruments..... AS 33, AS 34
 Gall stone forceps..... AS 32
Gauss
 Scalp flap forceps GO 61
Gelpi
 Skin- and vaginal retractors..... RE 48
Gemini
 Ligature forceps CF 33
Gerald
 Delicate dissecting forceps..... FC 14
 Delicate Tissue Forceps..... FC 31
Gerzog
 Mallets BS 83
Gillies
 Needle holders WO 17, WO 18
 Delicate tissue forceps..... FC 29
 Skin hooks RE 1
Gillies Slim
 Needle holders WO 17, WO 18
Gil-Vernet
 Wound retractors..... RE 3
Goelet
 Retractors RE 11
Goldmann-Fox
 Delicate dissecting scissors..... SC 24
 Gum scissors..... SC 24
 Gomco AS 42
Gomco
 Circumcision instrument..... AS 42
Good
 Tonsil scissors SC 57
Goodell
 Endospecula for cervix..... GO 23
Gorney
 Dissecting scissors..... SC 42, SC 43
 Suction raspatories TS 8
Gosset
 Abdominal retractors..... RE 54, RE 55
 Gouges..... BS 1–3, BS 5–8
Gourdet
 Uterine curettes..... GO 55
Gradle
 Cilia forceps..... FC 42
Graefe
 Delicate dissecting scissors..... SC 23
 Skin hooks RE 2
 Grasping forceps FC 39, GO 25
Grave
 Vaginal specula..... GO 4, GO 5
Gray
 Gall duct forceps AS 31
Grazil
 Surgical scissors SC 19
Green
 Retractors RE 20
Green-Armytage
 Uterine forceps..... GO 68
 Grip pliers..... BS 73
Gross-Maier
 Dressing forceps 52
Gruenwald
 Delicate dissecting forceps..... FC 18
 Guide needles..... TS 13

Guiding probes WO 46–50
 Gum scissors SC 24, SC 68
Guthrie
 Skin hooks RE 2
Guttman
 Secretion spoons AS 43
 Uterine secretion spoon..... GO 37
Guyon
 Catheter guide..... AS 42
 Kidney clamps AS 35
Guyon-Atrauma
 Kidney clamps AS 35
 Gynecological scissors..... SC 61–63
H
Haberer
 Spatulas..... RE 30
 Haemorrhoidal forceps..... AS 26, AS 27
 Haemorrhoidal ligators AS 28–30
Hajek
 Mallets BS 83
Hakansson
 Bone rongeur forceps BS 48
Halle
 Bone curettes BS 14
halsey
 Needle holders WO 10, WO 28
Halsted-Mosquito
 Hemostatic forceps CF 10, CF 11
Hardy
 Dissecting micro forceps FC 6
Harrington
 Retractors RE 26
Hartmann
 Bone rongeur forceps BS 46
 Hemostatic forceps CF 13
Hayes
 Sigmoid anastomosis clamps ... AS 18
Heaney
 Needle holders WO 11
 Parametrium forceps..... GO 39
 Retractors RE 27
 Uterine curettes..... GO 55
Heaney-Ballentine
 Hysterectomy forceps..... GO 41
Heaney-Slim
 Parametrium forceps..... GO 40
Hegar
 Needle holders WO 12
 Uterine dilators GO 22
hegar-baumgartner
 Needle holders WO 10, WO 23
Hegar-vascular
 Needle holders WO 29
Hegemann-Diethrich
 Vascular scissors..... SC 51
Hegenbarth
 Clip applying forceps WO 52
Heiss
 Ligature forceps CF 31
 Self-retaining retractors RE 31
 Hemostatic forceps CF 1–25
Henley
 Self-retaining retractors.... RE 39, RE 40



Henning
Plaster spreaderWO55

Henry
Cilia forceps..... FC42

Hey Groves
Bone holding forceps.....BS39

Heymann
Nasal scissors..... SC47

Heywood-Smith
Polypus and ovary forceps..... GO34
Haemorrhoidal forceps AS26
HF–Handles HF 1, HF2
HF–Handles with integrated cable for electrodes Ø 2.4 mm and 6–edge shaft HF 1
HF–Handles with integrated cable for electrodes Ø 4 mm and 6–edge shaft.. HF2

Hibbs
ChiselsBS6
GougesBS6
OsteotomesBS6
RetractorsRE27

Hoehn
Hemostatic forceps CF17
Raspatories.....BS25

Hoesel
Retractors RE 19
Vaginal retractors GO 19

Hoffmann
Tubing forceps.....CF50

Hohmann
Bone levers..... BS29, BS30

Hohmann-Aldinger
Bone levers.....BS30

Hoke
OsteotomesBS2
Holding pin.....HS 15

Holzbach
Hysterectomy forceps GO41

Hopkins
Plaster knives.....WO55

Hudson
Cutter.....BS63
Drills.....BS63
Handle.....BS63

Hunt
Micro tumor grasping forcepsFC8

Hunter
Splinter forceps FC40
Hysterectomy forceps.....GO41, GO42

I

Incision scissors.....SC21
Instrument box.....HS7, HS8
Instrument storing trays.....HS7
Instrument trays.....HS7, HS8
Intestinal and lung forceps FC38
Intestinal and pylorus clamps..... AS15
Intestinal and tissue grasping forcepsAS1–6
Intestinal clamps.....AS7–13
Iris scissors SC11, SC12

Israel

Retractors.....RE14

Iterson
Wound retractors.....RE6
IUD grasping forceps, flexible GO25

Ives-Fansler
AnoscopeAS23

J

Jackson
Vaginal specula..... GO7
Wound retractors.....RE3, RE5

Jacobs
Uterine tenaculum forceps..... GO32

Jacobson
Micro needle holdersWO4
Bone curettesBS15
Dissecting micro forceps FC5
Hemostatic forceps CF12

Jacobson-Adson
Delicate dissecting forceps..... FC11

Jameson
Needle holdersWO13
Delicate dissecting scissors.....SC25

Jameson-Werber
Delicate dissecting scissors.....SC25

Janet
Syringes.....TS11

Jansen
Bone curettesBS15
Bone rongeur forcepsBS47, BS48
Ear dressing forceps FC23
Raspatories.....BS19
Self-retaining retractorsRE32

Jansen-Gruenwald
Ear dressing forcepsFC23

Jarcho
Uterine tenaculum forceps..... GO28

Jars.....HS5

Jeffersen
Self-retaining retractorsRE36

Jobson-Horne
Cotton applicators..... TS19

Johns-Hopkins
Bulldog clamps..... 58
Ligature forcepsCF26

Joll (Friedmann)
Thyroid– and vaginal retractorsRE48

Jones
Towel forceps 45

Joseph
Dissecting scissors.....SC38
Raspatories.....BS20

Judd-Allis
Intestinal and tissue grasping forcepsAS3

Judd-Masson
Bladder retractorsAS38

Julian
Needle holdersWO27

K

Kahn
Uterine tenaculum forceps..... GO26

Kallmorgen
Vaginal specula sets..... GO7

Kalt
Micro needle holdersWO9

Kalt-Arruga
Micro needle holdersWO9

Kantrowitz
Ligature forcepsCF25

Kaye
Facelift and nasal scissorsSC37
Dissecting scissors.....SC41

Kazanjian
Bone cutting forceps.....BS58

Kelly
Polypus and ovary forceps..... GO33
Fistula scissorsSC62
Hemostatic forceps CF7, CF23
ProctoscopesAS23
RetractorsRE22, RE28
SphincteroscopesAS23

Kelly-Rankin
Hemostatic forcepsCF7

Kern
Bone holding forceps.....BS38

Kevorkian
Biopsy curettes.....GO45
Biopsy forceps.....GO50

Key
ElevatorsBS26
Kidney bowls.....HS3
Kidney clampsAS35
Kidney stone forceps.....AS36

Kielland
Obstetrical forceps.....GO64

kilner
Needle Holders.....WO29

Kilner
Dissecting scissors.....SC38
Skin hooksRE1
Swedish patternSC38

Kirschner
Abdominal retractors.....RE60
Drill wiresBS67
Guiding probes.....WO48

Klapp
Tendon sheath hooksBS87

Kleinert-Kutz
Bone rongeur forcepsBS50
Fine wound retractorsRE2
Tendon passing forceps.....BS85
Tenotomy scissors.....SC22

Kleinschmidt
Appendectomy clampAS14

Klima-Rosegger
Sternal puncture needles.....TS4

Knapp
Eye scissors.....SC11
Knot tier.....WO50



Knowles		Lawrence		Lockwood-Allis	
Bandage scissors.....	SC 74	Ligature forceps	CF 38	Intestinal and tissue grasping forceps	AS 2
Kocher		Lazar		Lorenz	
Bone retractors.....	BS 33, BS 34	Micro suture forceps	FC 2	Bandage scissors.....	SC 74
Hemostatic forceps	CF 6	Lead hands	BS 87	Lorna	
Intestinal clamps.....	AS 12	Legueu		Towel forceps	CF 47
Retractors.....	RE 16, RE 17, RE 23	Bladder retractors	AS 38	Loute	
Kocher-Atrauma		Leksell		Bone wire tighteners	BS 78
Intestinal clamps.....	AS 13	Bone rongeur forceps	BS 55, BS 56	Lovelace	
Kocher-Langenbeck		Lempert		Hemostatic forceps	CF 19
Retractors	RE 17	Bone rongeur forceps	BS 47	Love (Morse)	
Kocher-Wagner		Lerliche		Retractors.....	RE 7
Retractors	RE 17	Hemostatic forceps	CF 9	Lower	
Koenig		Retractors.....	RE 27	Gall duct clamp forceps.....	CF 32
Elevators	BS 27	Lewin		Lowman	
Guiding probes.....	WO 49, WO 50	Bone holding forceps.....	BS 37	Bone holding forceps.....	BS 44
Raspatories.....	BS 19	Lewkowitz		Lucae	
Koerte		Lithotomy forceps.....	AS 40	Ear dressing forceps	FC 23
Retractors.....	RE 14	Lexer		Mallets	BS 83
Kogan		Dissecting scissors.....	SC 26	Lucas.....	BS 1
Endospecula for cervix.....	GO 23	Gouges	BS 5, BS 7	Chisels	BS 1
Kristeller		Osteotomes	BS 5	Gouges	BS 1
Vaginal specula.....	GO 8–12	Lexer-Fino		Luer	
Vaginal specula sets.....	GO 8–12	Dissecting scissors.....	SC 26	Bone rongeur forceps	BS 49
Kronecker		Lid for perforated basket.....	HS 9–11	Retractors.....	RE 8
Ligature needles.....	WO 38	Lid for wire basket.....	HS 9–11	Luer-Friedmann	
Kuehne		Ligature forceps.....	CF 10, CF 25–39	Bone rongeur forceps	BS 45
Cilia forceps.....	FC 42	Ligature needles	WO 38–43	Luer-Koerte	
L		Ligature scissors.....	SC 45–60	Gall duct instruments	AS 34
La Grange		General information.....	SC 45	Luer-Lock Adapter.....	TS 12
Gum scissors.....	SC 68	Lister		M	
Lahey		Bandage scissors	SC 72	Mastercut	
Ligature forceps	CF 38	Sinus forceps.....	51	Mastercut scissors	SC 28, SC 34
Retractors.....	RE 15	Lister-Excentric		Magill	
Lambotte		Bandage scissors	SC 73	Catheter forceps.....	TS 10
Bone holding forceps.....	BS 41	Liston		Maingot	
Osteotomes	BS 4	Amputation knives.....	SK 8	Clamp forceps	CF 40
Raspatories.....	BS 18	Bone cutting forceps.....	BS 57	Mallets.....	BS 79–84
Landau		Liston-Key-Horsley		Marham-Meyerding	
Trocars.....	TS 2	Bone cutting forceps.....	BS 59	Self-retaining retractors	RE 49
Landolt		Lithotomy forceps.....	AS 40	Marquardt	
Ear dressing forceps	FC 24	Littauer		Bone rongeur forceps	BS 52
Lane		Ligature scissors	SC 60	Martin	
Bone holding forceps.....	BS 42	Littauer-Liston		Bone holding forceps.....	BS 36
Stomach and intestinal twin clamps	AS 16	Bone cutting forceps.....	BS 57	Retractors.....	RE 24
Tissue forceps	FC 36	Little		Uterine tenaculum forceps.....	GO 26
Towel forceps	48	Retractors.....	RE 7	Martini	
Lane-Trethowan		Littler		Bone curettes	BS 15
Bone levers.....	BS 30	Ligature scissors	SC 60	Martin (Simpson)	
Langenbeck		Littlewood		Uterine probes.....	GO 24
Bone holding forceps.....	BS 37	Intestinal and tissue grasping forceps	AS 3	Masson	
Elevators	BS 25	Lloyd-Davis		Needle holders	WO 13, WO 33
Raspatories.....	BS 18	Sigmoid anastomosis clamps	AS 18	Mathieu	
Resection knife.....	SK 9	Lockart-Mummary		Needle holders	WO 35–37
Retractors.....	RE 14–16	Fistula probes	TS 17	Foreign body forceps	AS 43
Saws	BS 61	Locklin		Rectal specula.....	AS 21
Langenbeck-Green		Gum scissors.....	SC 68	Retractors.....	RE 13
Retractors.....	RE 9, RE 10	Lockwood		Mathieu-Kohler	
Lateral specula.....	GO 5	Intestinal and tissue grasping forceps	AS 3	Needle holders	WO 36
Lateral speculum	GO 19				



- Mathieu-Metzenbaum**
Needle holders WO37
- Matzenauer**
Vaginal specula..... GO 13
- Mayfield**
Bone rongeur forceps BS51
- Mayo**
Mastercut scissors..... SC28
Dissecting scissors..... SC27–29
Grasping forceps..... FC39
Sterilization clamps HS 1
- Mayo-Adams**
Self-retaining retractors RE38
- Mayo-Hegar**
Needle holders WO 11, WO22–24
- Mayo-Noble**
Dissecting scissors..... SC30
- Mayo-Robson**
Intestinal clamps..... AS9, AS 10
- Mayo-Robson Atrauma**
Intestinal clamps..... AS 11
- Mayo-Stille**
Dissecting scissors..... SC29, SC30
- Mc Culloch**
Cannulas..... TS7
- Mc Donald**
Elevators BS27
- Mc Givney**
Haemorrhoidal forceps AS27
Haemorrhoidal ligators..... AS29
- Mc Indoe**
Vascular scissors..... SC49
Bone cutting forceps..... BS58
Delicate dissecting forceps..... FC12
Delicate tissue forceps..... FC29
- Mc Kenzil**
Cutter..... BS63
- Mc Lean**
Obstetrical forceps..... GO64
- Mead**
Bone rongeur forceps BS47
Mallets BS84
Measuring jugs..... HS3
Measuring jugs and kidney bowls HS3
Medicine cups..... HS4
- Meeker**
Ligature forceps CF32
Meniscus knives..... BS35
Metal catheters for men..... AS41
Metal catheters for women..... AS41
Metal label for wire basket..... HS14
Metzenbaum HF6
Mastercut scissors SC34
Bipolar scissors HF6
Dissecting scissors..... SC32–36
Dissecting scissors..... SC34
Supreme SC35
- Metzenbaum-Fino**
Dissecting scissors..... SC31, SC33
- Metzenbaum-S**
Dissecting scissors..... SC35
- Meyerding**
Retractors RE26
Special retractors RE48
- Michel**
Clip applying forceps WO52
Clip applying and removing forceps WO51
- Micro Adson**
Delicate dissecting forceps..... FC11
Delicate tissue forceps..... FC25
- Micro-Adson-Biemer**
Delicate tissue forceps..... FC27
- Micro clips..... CF59
Micro forceps, round handle FC10
Micro jewelers forceps FC1
- Micro-Mosquito**
Hemostatic forceps CF12
Micro needle holders..... WO3–9
- Micro-Ryder**
Needle holders WO31
- Micro-Semken**
Delicate tissue forceps..... FC28
Micro spring scissors..... SC7–10
Micro suction tubes TS9
Micro suture forceps..... FC2–4
Micro tumor grasping forceps..... FC8, FC9
- Microvascular**
Needle holders WO30
- Middeldorpf**
Retractors RE20
- Mikulicz**
Peritoneal forceps CF42, CF43
Retractors RE28
- Milan**
Biopsy and aspirating curettes GO58
- Miller**
Bone rasps..... BS16
- Milligan**
Self-retaining retractors RE41
- Millin**
Bladder neck spreader..... AS40
Bladder retractors AS37
Mini baskets with lid..... HS13
Mini-Blade-System..... SK1
- Mini-Friedmann**
Bone rongeur forceps BS45
- Mini-Gemini**
Ligature forceps CF34
- Mini-Hohmann**
Bone levers..... BS28
- Mini-Lambotte**
Osteotomes BS4
- Mini-Langenbeck**
Wound retractors..... RE3
- Mini-Lexer**
Gouges BS5
Osteotomes BS5
- Mini-Lowman**
Bone holding forceps..... BS44
- Mini-Townsend-Down**
Uterine biopsy forceps..... GO53
- Mini-Townsend-Up**
Uterine biopsy forceps..... GO53
- Mixer**
Ligature forceps CF35, CF37
- Mixer-Slim**
Ligature forceps CF36
- Modell Rudolf**
Bandage scissors SC71
Surgical scissors SC20
- Mogen**
Circumcision instruments AS42
- Mollison**
Self-retaining retractors RE36, RE37
- Molt**
Raspatories..... BS17
- Monopolar Electrodes with 6–edge shaft
Ø 2.4 mm..... HF3, HF4
Monopolar Electrodes with 6–edge shaft
Ø 4 mm..... HF4
- Morris**
Retractors RE19
- Mosquito-Dandy**
Hemostatic forceps CF18
- Moynihan**
Hemostatic forceps CF16
- Munich Pattern**
Biopsy instruments..... GO44
- Murphy-Lane**
Bone levers..... BS31
- Museux**
Uterine tenaculum forceps..... GO31, GO32
- Myoma screw..... GO37
Myrtle leaf probes TS15
- ## N
- Naegele**
Obstetrical forceps..... GO64
Perforator..... GO62
Nail instruments BS60
Nail nipper..... BS60
Nail pulling forceps BS60
Nail scissors..... SC69
Nail splitting scissors..... SC69
Nasal scissors..... SC37, SC47, SC48
Needle holders..... WO10–35
- Negus**
Suction dissectors..... TS8
Tonsil forceps CF40
- Neivert**
Needle holders WO19, WO20
- Nelaton**
Directors TS16
- Nelson**
Intestinal and lung forceps..... FC38
Trocars..... TS1
Nerve dissecting scissors..... SC55
Neurosurgical scissors SC55
- New Orleans**
Needle holders WO11, WO21
Tissue forceps FC36
- News**
Trachea hook RE3
- New Suture**
Surgical scissors SC21
- Nissen**
Hemostatic forceps CF20
- Northbent**
Ligature scissors SC60



Noto			
Polypus and ovary forceps.....	GO 34		
Novak			
Biopsy instruments.....	GO 44		
Novak-Schoechaert			
Biopsy instruments.....	GO 44		
O			
Obstetrical forceps.....	GO 63–65		
Obstetrics.....	GO 61, GO 62		
Ochsner			
Suture forceps.....	FC 20		
Trocars.....	TS 2		
Ochsner-Kocher			
Hemostatic forceps.....	CF 3–5		
O' Connor			
Fine wound retractors.....	RE 2		
Oehler			
Delicate tissue forceps.....	FC 30		
Olivecrona			
Bone rongeur forceps.....	BS 46		
Ollier			
Retractors.....	RE 13		
Olsen-Hegar			
Needle holders.....	WO 15, WO 16		
Ombredanne			
Mallets.....	BS 81		
O'Shaughnessy			
Ligature forceps.....	CF 35		
Osteotomes.....	BS 1–6		
O'Sullivan-O'Connor			
Abdominal retractors.....	RE 62		
Ovary forceps.....	GO 36		
Overholt-Geissendoerfer			
Ligature forceps.....	CF 30		
Overholt-Mixter			
Ligature forceps.....	CF 31		
Overholt-S			
Ligature forceps.....	CF 28		
Overholt-Slim			
Ligature forceps.....	CF 28		
Ovum forceps.....	GO 66, GO 67		
P			
Pacific-Kevorkian			
Uterine biopsy forceps.....	GO 52		
Par			
Needle holders.....	WO 19		
Parametrium forceps.....	GO 38–40		
Parametrium scissors.....	SC 66		
Park			
Rectal spreader.....	AS 24		
Parker			
Retractors.....	RE 12		
Parker-Langenbeck			
Retractors.....	RE 11		
Parker-Mott			
Retractors.....	RE 12		
Parsonnet			
Self-retaining retractors.....	RE 32		
Partition holding pin.....	HS 15		
Partition sheets.....	HS 15		
Partsch			
Mallets.....	BS 84		
Patella forceps.....	BS 43		
Patterson			
Biopsy forceps.....	GO 49		
Payr			
Guiding probes.....	WO 46		
Intestinal and pylorus clamps.....	AS 15		
Pean			
Hemostatic forceps.....	CF 6, CF 14		
Trocars.....	TS 2		
Peers-Bertram			
Towel forceps.....	46		
Peet			
Splinter forceps.....	FC 41		
Pelkmann			
Dressing forceps.....	53		
Pelterson			
Cotton applicators.....	TS 18		
Penderson			
Vaginal specula.....	GO 5		
Penis clamps.....	AS 43		
Pennington			
Hemostatic forceps.....	CF 14		
Percy			
Amputation retractor.....	BS 41		
Perforated basket.....	HS 9–11		
Perforator.....	GO 62		
Perineum (Episiotomy) scissors... SC 65			
Peritoneal forceps.....	CF 42–44		
Perkins			
Self-retaining retractors.....	RE 33		
Perthes			
Reamers.....	BS 66		
Pestles.....	BS 2		
Phaneuf			
Hysterectomy forceps.....	GO 41		
Piccolo			
Cotton applicators.....	TS 18, TS 19		
Piper			
Obstetrical forceps.....	GO 65		
Pituitary forceps.....	FC 21		
Placenta forceps.....	GO 67		
Plaster cast instruments.....	WO 55–58		
Plaster knives.....	WO 55		
Plaster saw.....	WO 55		
Plaster saws with oscillating saw blades.....	WO 57		
Plaster shears.....	SC 75, WO 56		
Plaster spreader.....	WO 55, WO 56		
Plester			
Self-retaining retractors.....	RE 34		
Pocket instrument set.....	WO 53		
Polypus and ovary forceps.....	GO 33, GO 34		
Poole			
Cannulas.....	TS 3		
Poppen			
Cannulas.....	TS 6		
Potts-Smith			
Delicate dissecting forceps.....	FC 18		
Delicate tissue forceps.....	FC 30		
Vascular scissors.....	SC 50		
Pozzi			
Uterine tenaculum forceps.....	GO 27		
Pratt			
Fistula probes.....	TS 17		
Haemorrhoidal forceps.....	AS 26		
Rectal specula.....	AS 20		
Uterine tenaculum forceps.....	GO 29		
Pribram			
Micro suction tubes.....	TS 9		
Probes.....	TS 14–17		
Probe with eye.....	TS 14		
Proctoscopes.....	AS 23		
Propylux, handels.....	BS 5, BS 23		
Prostatic retractor.....	AS 39		
Providence			
Hemostatic forceps.....	CF 10		
Putti			
Bone rasps.....	BS 16		
Pylorus spreader.....	AS 14		
Q			
Quervain			
Elevators.....	BS 26		
Quick recharger for accu.....	WO 57		
R			
Radolf			
Nail pulling forceps.....	BS 60		
Ragnell-Davis			
Retractors.....	RE 10		
Raimondi			
Hemostatic forceps.....	CF 17		
Ralk			
Splinter forceps.....	FC 41		
Ramplay			
Sponge holding forceps.....	57		
Randall			
Kidney stone forceps.....	AS 36		
Raspatories.....	BS 17–22, BS 24–25		
Rasps.....	BS 16		
Razor blade breaker.....	SK 5, SK 6		
Razor blade holder.....	SK 5, SK 6		
Razor blades.....	SK 5		
Reamer.....	BS 66		
Recamier			
Uterine curettes.....	GO 56, GO 57		
Recharger for accu.....	WO 57		
Rectal biopsy forceps.....	AS 25		
Rectal probes.....	TS 16		
Rectal specula.....	AS 20, AS 21		
Rectal spreader.....	AS 24		
Rectoscopes.....	AS 22, AS 23		
Redon			
Guide needles.....	TS 13		
Reiner			
Plaster knife.....	WO 55		
Resano			
Sigmoid anastomosis clamps.....	AS 18		
Resection knives.....	SK 9		
Retractors.....	RE 7–29		



Reverdin			
Spatulas.....	RE 30		
Reverdin needles.....	WO 44, WO 45		
Reynolds			
Delicate dissecting scissors.....	SC 24		
Dissecting scissors.....	SC 39		
Rib shears.....	SC 76		
Ribbon Type, Iris scissors.....	SC 12		
Ricard			
Abdominal retractors.....	RE 53		
Richardson			
Retractors.....	RE 21		
Richardson-Eastman			
Retractors.....	RE 21		
Richter-Heath			
Clip forceps.....	WO 51		
Rigby			
Self-retaining retractors.....	RE 49		
Roberts			
Hemostatic forceps.....	CF 22		
Rochard			
Abdominal retractors.....	RE 64		
Blades.....	RE 64		
Fixation device.....	RE 64		
Mounting frame.....	RE 64		
Rochester-Carmalt			
Hemostatic forceps.....	CF 18		
Rochester-Pean			
Hemostatic forceps.....	CF 1, CF 2		
Roettgen-Ruskin			
Bone rongeur forceps.....	BS 52		
Rogers			
Parametrium forceps.....	GO 38		
Rongeur forceps.....	BS 45–56		
Ross			
Retractors.....	RE 29		
Round bowls.....	HS 4–6		
Round pliers.....	BS 60		
Roux			
Retractors.....	RE 11		
Rudd			
Haemorrhoidal ligators.....	AS 29		
Rudolf			
Dissecting scissors.....	SC 39		
Rudolf Pattern			
Wire cutting pliers.....	BS 75, BS 76		
Rudolf (Swedish Pattern)			
Needle holders.....	WO 31		
Rumel			
Ligature forceps.....	CF 26		
Ruskin			
Bone rongeur forceps.....	BS 51, BS 52		
Ruskin-Liston			
Bone cutting forceps.....	BS 58		
Russian Pattern			
Grasping forceps.....	FC 39		
Ryder			
Needle holders.....	WO 30		
S			
Saenger			
Ovum forceps.....	GO 67		
Salpingograph.....	GO 59, GO 60		
Sanvenero			
Delicate scissors.....	SC 15		
sarot			
Needle holders.....	WO 32		
Sarot			
Hemostatic forceps.....	CF 24		
Satterlee			
Saws.....	BS 61		
Sauerbruch			
Retractors.....	RE 15		
Waste forceps.....	HS 1		
Saw blades.....	WO 58, BS 61–62		
Saws.....	BS 61, BS 62		
Sawtell			
Dissecting forceps.....	CF 35		
Scalpels.....	SK 1–4		
Scalp flap forceps.....	GO 61		
Schaaf			
Cilia forceps.....	FC 42		
Schacke			
Grasping forceps.....	GO 25		
Schaedel			
Towel forceps.....	45		
Schede			
Bone curettes.....	BS 11		
Scherbak			
Vaginal specula.....	GO 21		
Schink			
Dermatome.....	SK 10		
Schmieden			
Guiding probes.....	WO 49		
Ligature needles.....	WO 42		
Schmieden-Dick			
Ligature needles.....	WO 42		
Schmieden-Payr			
Guiding probes.....	WO 49		
Schneider-Sauerbruch			
Raspatories.....	BS 18		
Schroeder			
Uterine scoops.....	GO 54		
Uterine tenaculum forceps.....	GO 26, GO 30		
Schubert			
Biopsy forceps.....	GO 46		
Schuknecht			
Suction needle.....	TS 7		
Schultze			
Salpingograph.....	GO 59, GO 60		
Schumacher			
Biopsy forceps.....	GO 47, GO 50		
Umbilical scissors.....	SC 64		
Schwartz			
Applying forceps.....	59		
Micro clips.....	59		
Seal.....	HS 14		
Secretion spoons.....	AS 43		
Sedillot			
Raspatories.....	BS 17		
Seldin			
Raspatories.....	BS 19		
Self-retaining retractors.....	RE 31–47, RE 49		
Hemilaminectomy retractor.....	RE 47		
Sellheim			
Elevating spoon.....	GO 61		
Semb			
Bone holding forceps.....	BS 39		
Bone rongeur forceps.....	BS 55		
Raspatories.....	BS 21		
Semken			
Delicate dissecting forceps.....	FC 12		
Delicate tissue forceps.....	FC 28		
Semm			
Abdominal retractors.....	RE 59		
Senn-Green			
Retractors.....	RE 10		
Senning			
Needle holders.....	WO 14		
Senn-Mueller			
Retractors.....	RE 9		
Septum cups.....	HS 4		
Sequestrum forceps.....	BS 36		
Seutin			
Bone scissors.....	SC 75		
Sharp curette, ceramic coated.....	BS 13		
Shortbent			
Ligature scissors.....	SC 60		
Siebold			
Uterine scissors.....	SC 63		
Sigmoid anastomosis clamps.....	AS 18, AS 19		
Silicone stud mat for baskets.....	HS 9		
Silicone stud mat for wire basket and perforated basket.....	HS 10–12		
Silver			
Dermatome.....	SK 10		
Simon			
Fistula hook.....	GO 37		
Retractors.....	RE 23		
Uterine scoops.....	GO 54		
Simpson			
Obstetrical forceps.....	GO 63		
Simpson-Braun			
Obstetrical forceps.....	GO 64		
Simpson-Luikart			
Obstetrical forceps.....	GO 63		
Sims			
Gynecological scissors.....	SC 61		
Rectal specula.....	AS 20, AS 21		
Uterine curettes.....	GO 56		
Uterine probes.....	GO 24		
Vaginal specula sets.....	GO 6		
Sims-Maier			
Dressing forceps.....	53		
Singley-Tuttle			
Intestinal and lung forceps.....	FC 38		
Sinus forceps.....	51		
Skene			
Uterine tenaculum forceps.....	GO 28		
Skin forceps.....	FC 37		
Skin hook.....	RE 2		
Skin hooks.....	RE 1		
Skin retractors.....	RE 48		
Smillie			
Meniscus knives.....	BS 35		
Smith-Buie			
Anal retractor.....	AS 22		
Smith-Petersen			
Bone rongeur forceps.....	BS 53		
Gouges.....	BS 3		
Osteotomes.....	BS 3		



Somer			
Uterine elevating forceps	GO 35		
Spare blade for dermatomes.....	SK 10		
Spatulas	RE 30		
Special retractors	RE 48		
Spencer			
Ligature scissors	SC 59		
Spencer-Fino			
Ligature scissors	SC 59		
Spring scissors	SC 7–10		
Silver			
Spencer-Wells			
Ligature forceps	CF 39		
Sphincteroscopes.....	AS 23		
Spinal retractors	BS 35		
Spiral holder.....	HS 15		
Splinter forceps	FC 40, FC 41		
Sponge holding forceps	56, 57		
Spratt			
Bone curettes.....	BS 10		
Stacke			
Ear probes	TS 16		
Stainless steel tag.....	HS 14		
Standard			
Dissecting forceps.....	FC 19		
Standard Adson			
Delicate tissue forceps.....	FC 26		
Steinmann			
Pins	BS 69		
Tendon grasping forceps	BS 86		
Stellbrink			
Bone rongeur forceps	BS 45		
Sterile good tables.....	HS 16		
Sterile good transport trolley, closed... ..	HS 17		
Sterile good transport trolley, open	HS 17		
Sterilization clamps.....	HS 1		
Sterilization forceps	HS 1		
Sternal puncture needles	TS 4		
Stevens			
Tenotomy scissors.....	SC 22		
Stevens-Rudolf			
Tenotomy scissors.....	SC 22		
Stieglitz			
Splinter forceps	FC 41		
Stille			
Bone rongeur forceps	BS 56		
Chisels	BS 6		
Dissecting forceps.....	FC 19		
Drills.....	BS 64		
Gouges	BS 6		
Osteotomes	BS 6		
Plaster shears	SC 75, WO 56		
Stille-Barraya			
Tissue forceps	FC 36		
Stille-Liston			
Bone cutting forceps.....	BS 59		
Stille-Luer			
Bone rongeur forceps	BS 54		
Stille-Ruskin			
Bone rongeur forceps	BS 55		
St. Marks			
Retractors	RE 18		
Stockmann			
Penis clamps	AS 43		
Stomach and intestinal twin clamps	AS 16		
Stomach clamps.....	AS 14		
Strabismus scissors.....	SC 13, SC 23		
Strandell-Stille			
Tendon sheath hooks	BS 87		
Strasbourg Pattern			
Tissue forceps	FC 35		
Stratte			
Needle holders	WO 33		
Strauss			
Penis clamps	AS 43		
Suction cannulas	TS 4–7, TS 9		
Suction dissectors	TS 8		
Suction needle.....	TS 7		
Suction raspatories.....	TS 8		
Suction Tube			
Ceramic coated	TS 6		
Surgical scissors.....	SC 18–21		
Surgical scissors, slender pattern.....	SC 19		
Suture clips	WO 51		
Suture forceps	FC 20, FC 42, WO 36–37		
Suture hook.....	WO 50		
Suture scissors (Iris).....	SC 7–10		
SYME			
Raspatories.....	BS 21		
Syringes	TS 11		
T			
Taylor			
Delicate dissecting forceps.....	FC 15		
Delicate tissue forceps.....	FC 32		
Spinal retractor.....	BS 35		
Teale			
Uterine tenaculum forceps.....	GO 32		
Tendon grasping forceps.....	BS 86		
Tendon instruments	BS 85–87		
Tendon passing forceps	BS 85		
Tendon plating forceps.....	BS 86		
Tendon seizing forceps.....	BS 85, BS 86		
Tendon sheath hooks.....	BS 87		
Tenotomy scissors	SC 7, SC 9		
Thomas			
Uterine curettes.....	GO 55		
Thomas-Gaylor			
Biopsy forceps.....	GO 46		
Thoms-Allis			
Intestinal and tissue grasping forceps	AS 3		
Thyroid retractors	RE 48		
Tischler			
Biopsy forceps.....	GO 47		
Uterine biopsy forceps	GO 53		
Tischler-Morgan			
Biopsy forceps.....	GO 51		
Tissue forceps.....	FC 34–36		
Tissue forceps.....	FC 33		
Tissue grasping forceps	AS 5, AS 6		
Toennis			
Tonsil scissors	SC 56		
Toennis-Adson			
Tonsil scissors	SC 56		
Toennis-Adson Fino			
Arteriotomy scissors.....	SC 56		
Tohoku			
Towel forceps	47		
Tongue holding forceps.....	57		
Tonsil forceps.....	CF 40		
Tonsil scissors.....	SC 56, SC 57		
Towel forceps.....	CF 45–48		
Trachea retractors.....	RE 3–6		
Travers			
Self-retaining retractors	RE 45		
Trays.....	HS 5–8		
Trélat			
Vaginal specula.....	GO 4		
Treves			
Tissue forceps	FC 35		
Triangular basins.....	HS 2		
Triangular bows and bed pans	HS 2		
Trocars	TS 1, TS 2		
Trocar set	TS 1		
Troeltsch			
Ear dressing forceps	FC 24		
Troeltsch (Wilde)			
Ear dressing forceps	FC 24		
Trolleys	HS 16, HS 17		
Troutman-Chris			
Razor blade breaker	SK 5		
Tubing forceps	CF 49, CF 50		
Tuebinger pattern			
Self-retaining retractors	RE 37		
Tuffier			
Hemostatic forceps	CF 14		
Spatulas.....	RE 30		
U			
Uffenrode			
Bone curettes	BS 12		
Ulrich			
Dressing forceps	CF 51		
Umbilical cord clamp.....	GO 62		
Umbilical scissors.....	SC 64		
Universal			
Cotton applicators.....	TS 19		
Sterilization forceps.....	HS 1		
Trocar set.....	TS 1		
Urethral Bougies	AS 41		
Urology instruments	AS 39–43		
USA pattern			
Chisels	BS 2		
Dissecting forceps.....	FC 20		
Gouges	BS 2		
Osteotomes	BS 2		
Plaster spreader	WO 56		
Tissue forceps	FC 34		
Umbilical scissors.....	SC 64		
Uterine biopsy forceps ...	GO 52, GO 53		
Uterine curettes	GO 55–57		



Uterine depressor GO 24
 Uterine dilators GO 22
 Uterine elevating forceps
 GO 35, GO 36
 Uterine forceps GO 68
 Uterine probes GO 24
 Uterine scissors SC 63
 Uterine scoops GO 54
 Uterine secretion spoon GO 37
 Uterine tenaculum forceps ... GO 26–32

V

Vaginal forceps GO 43
 Vaginal retractors RE 48, GO 19
 Vaginal specula GO 1–21
 Vaginal specula sets GO 6–12

Valleix

Uterine probes GO 24

Van Burren

Urethral bougies AS 41

Van Doren

Biopsy forceps GO 47

Vannas

Micro spring scissors SC 7

Vascular scissors
 SC 49–51, SC 53–54

Vascular scissors probe-pointed
 SC 49

Vault

Polypus and ovary forceps GO 33

Vein scissors SC 8

Venae sectio set WO 54

Verbrugge

Bone holding forceps BS 40

Verbrugge-Mueller

Bone levers BS 30

Vienna Pattern

Suture hook WO 50

Virchow

Autopsy knives SK 9

Vise

Micro jewelers forceps FC 1

Volkman

Bone curettes BS 9, BS 12, BS 14

Bone retractors BS 32

Wound retractors RE 6

W

Wachenfeldt

Clip applying forceps WO 52

Wagensteen

Needle holders WO 13, WO 34

Wagner

Delicate surgical scissors SC 17

Waldmann

Perineum (Episiotomy) scissors
 SC 65

Walter-Carmalt

Splinter forceps FC 40

Walton

Delicate scissors SC 15

Wangensteen

Dissecting forceps FC 21

Waste forceps HS 1

Watson-Cheyne

Elevators BS 27

Probes TS 14

Waugh

Delicate dissecting forceps FC 13

Delicate tissue forceps FC 30

Webster

Needle holders WO 10, WO 20

Weitlaner

Self-retaining retractors
 RE 35, RE 42

Weitlaner-Baby

Self-retaining retractors RE 41

Weitlaner-Wullstein

Self-retaining retractors RE 36

Wertheim

Gynecological scissors SC 61

Hysterectomy forceps GO 42

Peritoneal forceps CF 42

Wertheim-Cullen

Hysterectomy forceps GO 42

Westcott

Tenotomy scissors SC 7, SC 9

Wickstroem

Ligature forceps CF 37

Williams

Tissue grasping forceps AS 6

Williger

Bone curettes BS 12, BS 15

Elevators BS 26

Mallets BS 82

Raspatories BS 19

Wilmer

Delicate dissecting scissors SC 23

Winter

Ovum forceps GO 66

Wire basket HS 9–12

Wire cutting and bending pliers
 BS 72

Wire cutting pliers BS 74–76

Wire cutting scissors SC 70

Wire holding forceps BS 72

Wire twisting forceps
 BS 70–71, BS 73

Wolff

Plaster breaker WO 56

Wound retractors RE 3–6

Wound retractors, fine RE 1, RE 2

Wound suture forceps WO 51

Wrapping drape, cotton HS 15

Wrench BS 77

Wrigley

Obstetrical forceps GO 63

Wundspreizer RE 46

Wylie

Retractors RE 20

X

Y

Yankauer

Raspatories BS 25

Yankauer-Standard

Cannulas TS 3

Yasargil

Dissecting micro forceps FC 5

Micro tumor grasping forceps FC 9

Yeoman

Rectal biopsy forceps AS 25

Young

Prostatic retractor AS 39

Urology instruments AS 39

Z

Zaufal-Jansen

Bone rongeur forceps BS 51

Zenker

Ligature forceps CF 27





A

Abfallzange HS 1
 Abortus- und Plazentazangen..... GO 67
 Abortuszangen GO 66
Adson
 Arterienklemmen CF 20
 Feine chirurgische Pinzetten
 FC 25–27
 Hohlmeißelzangen..... BS 50
 Hypophysenpinzetten FC 21
 Kanülen..... TS 5
 Mikro-Nahtpinzetten FC 2
 Nadelhalter WO 14
 Raspatorien BS 20
 Wundspreizer..... RE 43–44, RE 46–47
Adson-Brown
 Hautpinzetten FC 37
Adson-Ewald
 Feine chirurgische Pinzetten..... FC 26
Adson-Graefe
 Hautpinzetten FC 37
Adson Standard
 Feine anatomische Pinzetten FC 11
 Akku für oszillierender Gipsäge.....
 WO 57
Alderdyce
 Elevatorien BS 27
alexander
 Uterus-Biopsiezangen GO 52
Alexander
 Flachmeißel BS 2
 Hohlmeißel..... BS 2
 Raspatorien BS 19
Allen
 Magenklemmen..... AS 14
Allis
 Darm- und Gewebefasszangen.. AS 1
Allis-Adair
 Darm- und Gewebefasszangen
 AS 2
Alm
 Wundspreizer..... RE 31
 Amniotom für das Amnionmembran
 GO 28
 Amputationsmesser..... SK 8
 Amputationsretraktor..... BS 41
 Analspreizer AS 22, AS 24
 Anastomosenklemmen..... AS 17
 Anatomische Mikro-Pinzetten
 FC 5–7
 Anatomische Pinzetten..... FC 19–21
 Anatomische Pinzetten, Standard.....
 FC 19
 Anatomische Skalpelle mit Metallheft..
 SK 7
Anderson-Adson
 Wundspreizer..... RE 43
Andrew-Pynchon
 Kanülen..... TS 3
 Anlegezangen 59
 Anschlusskabel..... HF 18
 Anuskope AS 23
 Arterienklemmen..... CF 1–25
 Atraumatische Pinzetten..... FC 22

Augenscheren..... SC 11
Austin
 Mikro-Nahtpinzetten FC 2
Auvard
 Scheidenspekula GO 20
B
Babcock
 Darm- und Gewebefasszangen
 AS 4
Babcock-Atrauma
 Darm- und Gewebefasszangen
 AS 4
Baby-Adson
 Arterienklemmen CF 20
Baby-Allis
 Darm- und Gewebefasszangen
 AS 1
Baby-Balfour
 Bauchdeckenhalter RE 56
Baby-Collin
 Bauchdeckenhalter RE 50
Baby-Crile
 Arterienklemmen CF 8
Baby-Crile-Wood
 Nadelhalter WO 26
Baby-Doyen
 Darmklemmen AS 7
Baby-Kocher
 Darmklemmen AS 11
Baby-Lexer (Knapp)
 Facelift und Nasenscheren SC 37
Baby-Metzenbaum
 Präparierscheren..... SC 31
Baby-Mikulicz
 Peritoneumklemmen 42
Baby-Mixer
 Ligaturklemmen..... CF 34
Baby-Olsen-Hegar
 Nadelhalter WO 15
Baby-Overholt
 Ligaturklemmen..... CF 27
Baby-Roux
 Wundhaken..... RE 11
Baby-Senn-Mueller
 Wundhaken..... RE 10
Baby-Tischler
 Biopsiezangen..... GO 51
Backhaus
 Tuchklemmen 46
Bainbridge
 Arterienklemmen CF 19
Bakes
 Gallengangdilatoren..... AS 33
Balfour
 Bauchdeckenhalter RE 56–58
Balfour USA-Modell
 Bauchdeckenhalter RE 58
Ballentine
 Hysterektomieklammern GO 41
Bane-Hartmann
 Hohlmeißelzangen..... BS 45

Barnes-Neville
 Geburtszangen..... GO 65
Baron
 Kanülen..... TS 7
Barr
 Rektum-Spekula..... AS 21
Barraquer
 Fadenpinzetten..... FC 42
 Mikro-Nadelhalter..... WO 8, WO 9
 Rasierklingshalter..... SK 6
Barraquer-Troutman
 Mikro-Nadelhalter..... WO 8
Barrett
 Hakenzangen..... GO 26
 Plazentarzangen..... GO 67
Barsky
 Feine Wundhäkchen..... RE 2
 Bauchdeckenhalter..... RE 50–64
Beacham
 Amniotom GO 28
Beckmann-Adson
 Wundspreizer..... RE 45
Beckmann-Adson (Standard)
 Wundspreizer..... RE 46
Beckmann-eaton
 Wundspreizer..... RE 47
Beebee
 Kronenscheren SC 67
Beer
 Cilienpinzetten FC 42
Bengolea
 Arterienklemmen CF 21
Bennett
 Knochenheber BS 31
Benson
 Pyloruspreizer..... AS 14
 Bereitstellungstische HS 16
Berger
 Biopsiezangen GO 49
Bergmann
 Hämmer BS 79, BS 80
 Verbandscheren SC 73
 Wundhäkchen..... RE 5
Bernhard
 Tuchklemmen 48
 Beschneidungsinstrumente..... AS 42
Beyer
 Hohlmeißelzangen..... BS 47, BS 51
Biemer
 Venenscheren..... SC 8
 Biopsieinstrumente..... GO 37, GO 44
 Biopsieküretten..... GO 45
 Biopsie- und Absaugküretten GO 58
 Biopsiezangen GO 46–49, GO 51
 Bipolare Anschlusskabel für bipolare
 Pinzetten 2–Pin Stecker..... HF 18
 Bipolare Anschlusskabel für bipolare
 Pinzetten Flachstecker HF 18
 Bipolare Anschlusskabel für Scheren ..
 HF 6
 Bipolare Pinzetten..... HF 7–17
 Bipolare Pinzetten, allgemeine Information
 HF 7
 Bipolare Pinzetten, Hartmetall.....
 HF 16–17



Bipolare Pinzetten NON-STICK	HF 10–11	Brophy	Feine anatomische Pinzetten FC 17	Cheron	Tupferzangen..... 54
Bipolare Pinzetten, NON-STICK	HF 7–9, HF 12–14	Feine chirurgische Pinzetten..... FC 31	Brophy (Sullivan)	Child	WundnahtpinzetteWO 51
Bipolare Pinzetten Standard	HF 10–11	Feine chirurgische Scheren SC 17	Brown	Chirurgische Pinzetten FC 33–36	Chirurgische Scheren SC 18–21
Bipolare Pinzetten, Standard	HF 7–9, HF 12–15	Brunner	Hautpinzetten FC 37	Chirurgische Scheren, schlankes Modell	SC 19
Bipolare Scheren SC 46, HF 5–6		Führungs-Hohlsonden	Nadelhalter WO 10	Chirurgisches Taschenbesteck	WO 53
Allgemeine Information SC 46	WO 47, WO 48	Bruner	Cilienpinzetten FC 42	
Bipolare Scheren, allgemeine Information	HF 5	Rektum-Anastomosenklemmen	Bruner	Cleveland	Hohlmeißelzangen..... BS 46
Bircher-Ganske	 AS 19	Wundhaken..... RE 24, RE 28	Cloward	Wundhäkchen..... RE 3
Knochenhaltezangen..... BS 37		Bruns	Scharfe Löffel BS 9, BS 10	Wundspreizer..... RE 37	
Birkett		Verbandschere SC 74	Bryant	Cobb	Hohlmeißel..... BS 8
Arterienklemmen CF 22		Buck	Korn-(Polypen) Zangen 51	Raspatorien BS 22–24	
Blake		Watteträger..... TS 18	Buck-Gramcko	Coller-Crile	Arterienklemmen CF 9
Uterusküretten..... GO 57		Bueie	Knochenhebel BS 28	Collin	Arterienklemmen CF 15
Blasenhalsspreizer..... AS 40		Fistelsonden TS 16	Buie	Bauchdeckenhalter RE 50–52	Gewebefasszange..... AS 5
Blasenwundspreizer AS 37, AS 38		Klemmzange..... 40	Bulldogklemmen..... CF 58–61	Klammeranlage- u. Entfernungszangen	WO 51
Bleihände BS 87		Bunt	Sterilisierklammern..... HS 1	Nabelschnurklemmen GO 62	Rippenschere SC 76
Blepharoplastik Scheren SC 37		Burke	Uterus-Biopsiezangen GO 52	Scheidenspekula GO 1	Tupferzangen..... CF 54
Blinddarmklemme..... AS 14		Busch	Nabelschnurschere SC 64	Uterusfasszangen GO 35	Wundhaken..... RE 13
Blount		C		Zungenzangen CF 57	
Knochenhebel BS 31		Cairns	Arterienklemmen CF 16	Collin-Duval	Darm- und Lungenpinzetten FC 38
Blumenthal		Canny-Ryall	Wundhaken..... RE 19	Collin-Pozzi	Hakenzangen..... GO 27
Hohlmeißelzangen..... BS 48		Carroll	Sehnenschnitzzangen..... BS 86	Cone	Wundspreizer..... RE 44
Böhler		Carrel	Arterienklemmen CF 13	Cone (Adson-Baby)	Wundspreizer..... RE 41
Extensionsbügel..... BS 77		Caspar	Mini-Skalpellgriff SK 1	Converse	Nadelhalter WO 29
Hohlmeißelzangen..... BS 50		Wundhaken..... RE 17	Castanares	Cooley	Wundhaken..... RE 29
Knochensplitterzangen BS 57		Präparierschere SC 42	Castroviejo	Cooper	Unterbindungsnadeln..... WO 43
Bohrapparate..... BS 63–65		Hornhautschere SC 8	Mikro-Nadelhalter..... WO 6, WO 7	Cottle	Flachmeißel BS 3
Bohrdrähte BS 67–69		Rasierklingshalter..... SK 5	Rasierklingshalter, Schweizer Modell	Cottle	Fixierpinzette FC 23
Bolzenschneider BS 76	 SK 5	Castroviejo/Barraquer	Hämmer BS 83	Hautpinzetten FC 37
Bonney		Mikro-Nadelhalter..... WO 6	Castroviejo-Kalt	Nasenschere SC 48	Osteotome BS 3
Anatomische Pinzetten FC 20		Mikro-Nadelhalter..... WO 9	Cerclage-Instrumente..... BS 78	Raspatorien BS 20	
Chirurgische Pinzetten FC 36		Chaput	Arterienklemmen CF 13	Cottle-Jansen	Hohlmeißelzangen..... BS 48
Polypen- und Ovarienzangen..... GO 33		Charrière	Sägen..... BS 62	Crafoord	Arterienklemmen CF 25
Böttcher		Cheatle	Sterilisierzangen..... HS 1	Crile	Arterienklemmen CF 8
Tonsillen-Schere..... SC 57				Feine Wundhäkchen..... RE 1	Wundhaken..... RE 8
Boys-Allis					
Darm- und Gewebefasszangen .. AS 2					
Bozemann					
Nadelhalter WO 21					
Tupferzangen..... CF 54, CF 55					
BozemannDouglas					
Tupferzangen CF 55					
Brain					
Feine anatomische Pinzetten FC 13					
Feine chirurgische Pinzetten..... FC 29					
Brand					
Sehnenschnitzzangen BS 85					
Braun					
Hakenzangen..... GO 27, GO 29					
Scheidenspekula GO 14					
Uterus-Depressor GO 24					
Braun-Stadler					
Damm-(Episiotomie-)Schere..... SC 65					
Breisky					
Scheidenspekula GO 18					
Bristow					
Knochenhebel BS 31					
Brodie					
Rektal-Hohlsonden TS 16					



Crile-Murray
Nadelhalter WO 14

Crile-Rankin
Arterienklemmen CF 8

Crile-Wood
Nadelhalter WO 14, WO 26–28

Cusco
Scheidenspekula GO 2, GO 3

Cushing
Dekompressionshaken RE 9
Feine anatomische Pinzetten FC 16
Feine chirurgische Pinzetten FC 30
Feine Wundhäkchen RE 1
Fräser BS 63
Raspatorien BS 18
Wundhaken RE 7, RE 8

Cushing-Taylor
Feine anatomische Pinzetten FC 16

Czerny
Hakenzangen GO 28
Rektum-Spekula AS 20

D

Damm-(Episiotomie-)Scheren SC 65

Dandy
Arterienklemmen CF 18
Darmklemmen AS 7–13
Darmscheren SC 58
Darm- u. Gewebefasszangen AS 1–6
Darm- u. Lungenpinzetten FC 38

Daubenspeck
Scharfe Löffel BS 12

Davidson
Wundhaken RE 29

Dean
Zahnfleischscheren SC 68

Deaver
Chirurgische Scheren SC 20
Wundhaken RE 24, RE 25

De Bakey
Atraumatische Pinzetten FC 22
Gefäßscheren SC 50
Nadelhalter WO 25
Wundspreizer RE 49

De Bakey-Hess
Bulldogklemmen 59

Deckel für Drahtsiebkorb HS 9–11
Deckel für Siebkorb HS 9–11
Dekompressionshaken RE 9

De Lee
Polypen- und Ovarienzangen... GO 33

De Martel (Willet)
Kopfhautklemmen GO 61

De Martel-Wolfson
Anastomosenklemmen AS 17
Klemmenhalter AS 17
Schließzangen AS 17

Demel
Drahtumführungsnadeln BS 78

Denis-Brown
Bauchdeckenhalter RE 61

Derf
Nadelhalter WO 10, WO 20
Dermatome SK 10

Deschamps
Unterbindungsnadeln WO 39–41

Deschamps-Standard
Unterbindungsnadeln WO 38

Desjardins AS 32, AS 33

Desmarres
Wundhaken RE 8

Dieffenbach
Bulldogklemmen 58

Diethrich
Bulldogklemmen 60, 61

Dingmann
Knochenhalte-zangen BS 36

Dingmann (Modif.)
Knochenhalte-zangen BS 36

Dixon-Lovelace
Arterienklemmen CF 19
Doppelknopfsonden TS 14
Doppelte Spiralfeder HS 15

Douay
Biopsiezangen GO 50

Douglas
Cilienpinzetten FC 42

Doyen
Bauchdeckenhalter RE 63
Darmklemmen AS 7
Gynäkologische Scheren SC 62
Myomheber GO 37
Ovarienzangen GO 36
Raspatorien BS 21
Scheidenhalter GO 19
Scheidenspekula GO 15–17
Sonden TS 15
Wundhaken RE 22

Doyen-Atrauma
Darmklemmen AS 8

Doyen-Stille
Wundhaken RE 23

Drahtfasszangen BS 72
Drahtscheren SC 70
Drahtschneide- u. Biege-zange BS 72
Drahtschneidezangen BS 74–76
Drahtsiebkorb HS 9–12
Drahtspanninstrumente BS 78
Drahtspannzangen BS 70–71, BS 73
Drahtumführungsnadeln BS 78

Dratigues
Uterusfasszangen GO 35
Dreieckschalen HS 2
Dreieckschalen und Stechbecken HS 2

Dunhill
Arterienklemmen CF 15

Duplay
Hakenzangen GO 27

Durante
Fasspinzetten FC 39

Duval
Darm- und Lungenpinzetten FC 38
Gewebefasszange AS 5, AS 6

E
Edelstahlplakette HS 14
Einschlagtücher HS 15
Elevatoren BS 25–27

Emmet
Tupferzangen CF 54
Endarterektomie-Schere SC 49
Endospekula für Cervix GO 23

Engel
Gipssäge WO 55

Englisches Modell
Tuchklemmen 45
Entsorgungsmarke für Drahtsiebkörbe HS 14

Eppendorf
Biopsiezangen GO 50

Errico
Fräser BS 63
Ersatzklingen für Dermatome SK 10

Esmarch
Gipsmesser WO 55
Verbandscheren SC 73

Ewald
Feine anatomische Pinzetten FC 11
Extensionsbügel BS 77

F

Facelift- und Nasenscheren SC 37
Fadenschere (Iris) SC 11
Federscheren SC 7–10
Fadenfänger WO 50
Fadengabel WO 50
Fadenpinzetten FC 20, FC 42

Farabeuf
Raspatorien BS 17
Wundhaken RE 12

Farabeuf-Lambotte
Knochenhalte-zangen BS 41

Farrell
Watteträger TS 20
Fasspinzetten FC 39
Fasszangen GO 25

Faure
Biopsiezangen GO 48

Faure
Klemmzangen 41
Peritoneumklemmen 44

Fehland
Rektum-Anastomosenklemmen AS 19

Feilchenfeld
Splitterpinzetten FC 40

Fein
Watteträger TS 18
Feine anatomische Pinzetten FC 11–18
Feine chirurgische Pinzetten FC 25–32
Feine chirurgische Scheren SC 16, SC 17
Feine Präparierscheren SC 22–25
Feine Scheren SC 11–15
Feine Wundhäkchen RE 1, RE 2

Fergusson
Hämorrhoidalzangen AS 26
Kanülen TS 4, TS 5



Knochenhaltezangen.....BS38
Ferris-Smith
 Chirurgische Pinzetten FC 35
 Fingerringssäge BS61
Fino
 Feine Scheren..... SC 15
 Iris- u. Fadenschere SC 11
Finocchietto
 Ligaturklemmen..... CF37
 Nadelhalter WO 13, WO 34
Finsen
 Wundspreizer..... RE31
Fish
 Sonden TS 14
 Wundspreizer..... RE 35
 Fistelhaken GO 37
 Fistelscheren.....SC62
 Fistelsonden..... TS 16, TS 17
 Fixierklammer HS 15
 Fixierpinzette..... FC23
 Flachmeißel.....BS 1–3, BS 6
 Flachzangen..... BS 60, BS 70, BS 73
Fomon
 NasenschereSC 47, SC 48
Fomon-Saber-Back
 Nasenschere SC 47
Ford Dixon
 Hämorrhoidal-Ligatoren..... AS 30
Förster-Ballenger
 Schwammzangen..... CF 56
Franz
 Bauchdeckenhalter RE 63
Frazier
 Bauchdeckenhalter RE 55
 Kanülen..... TS 5
 Mikro-Saugkanülen TS 9
Frazier (Fergusson)
 Kanülen..... TS 4
Freeman
 Präparierscheren.....SC 44
Freeman-Gorney
 Präparierscheren.....SC 41
Freeman-Kaye
 Präparierscheren.....SC 40
 Fremdkörperzange AS 43
Friedmann-Delikat
 Hohlmeißelzangen.....BS 46
Fritsch
 Wundhaken.....RE 22
Frohn
 Watteträger..... TS 20
Fuchsig
 Arterienklemmen CF 20
 Führungs-Hohlsonden..... WO 46–50
 Führungsnadeln TS 13
 Füße (Kunststoff), für Drahtsiebkorb
 HS 9–12

G

Gabelschlüssel BS 77
 Gallenkanal Instrumente.....AS 33–34
 Gallenkanalklemmzangen CF 32
 Gallenkanal-Klemmzangen
 AS 31, AS 32
 Gallensteinzange AS 32

Gauss
 Kopfschwanzzangen GO 61
 Geburtshilfe GO 61, GO 62
 Geburtslöffel GO 61
 Geburtszangen GO 63–65
 Gefäßschere..... SC 49–51, SC 53–54
 Gefäßschere mit Knopf.....SC 49
Gelpi
 Haut- und Vulvaspreizer.....RE 48
Gemini
 Ligaturklemmen.....CF 33
Gerald
 Feine anatomische Pinzetten FC 14
 Feine chirurgische Pinzetten..... FC 31
Gerzog
 HämmerBS 83
 Gewebefasszangen AS 5, AS 6
Gillies
 Feine chirurgische Pinzetten..... FC 29
 Hauthäkchen RE 1
 Nadelhalter WO 17, WO 18
Gillies Slim
 Nadelhalter WO 17, WO 18
Gil-Vernet
 Wundhäkchen..... RE 3
 Gipsmesser.....WO 55
 GipssägeWO 55
 Gipssägen mit oszillierenden Sägeblät-
 ternWO 57
 Gipsschere.....WO 56
 Gipsscheren.....SC 75
 Gipsspreizer WO 55, WO 56
 Gipsverband-Instrumente ... WO 55–58
Goelet
 Wundhaken..... RE 11
Goldmann-Fox
 Feine Präparierscheren SC 24
 Zahnfleissscheren SC 24
 Gomco AS 42
 Beschneidungsinstrument AS 42
Good
 Tonsillen-Scheren.....SC 57
Goodell
 Endospekula für Cervix GO 23
Gorney
 Präparierscheren SC 42, SC 43
 Saug-Raspatorien TS 8
Gosset
 Bauchdeckenhalter RE 54, RE 55
Gourdet
 Uterusküretten..... GO 55
Gradle
 Cilienpinzetten..... FC 42
Graefe
 Feine Präparierscheren SC 23
 Hauthäkchen RE 2
Grave
 Scheidenspekula GO 4, GO 5
Gray
 Gallenkanal-Klemmzangen..... AS 31
Grazil
 Chirurgische Scheren.....SC 19
Green
 Wundhaken.....RE 20
Green-Armytage
 Uterusklemmzangen GO 68

Gripzangen.....BS 73
Gross-Maier
 Kornzangen CF 52
Grünwald
 Feine anatomische Pinzetten FC 18
Guthrie
 Feine Wundhäkchen..... RE 2
Guttman
 Sekretlöffel AS 43
 Uterus-Sekretlöffel GO 37
Guyon
 Katheter-Einführungsinstrument.....
 AS 42
 Nierenklemmen AS 35
Guyon-Atrauma
 Nierenklemmen AS 35
 Gynäkologische Scheren.....SC 61–63

H

Haberer
 Spatel.....RE 30
Hajek
 HämmerBS 83
Hakansson
 Hohlmeißelzangen.....BS 48
 Hakenzangen GO 26–32
Halle
 Scharfe Löffel BS 14
Halsey
 Nadelhalter WO 10, WO 28
Halsted-Mosquito
 Arterienklemmen CF 10, CF 11
 HämmerBS 79–84
 Hämorrhoidal-Ligatoren AS 28–30
 Hämorrhoidalzangen AS 26, AS 27
Hardy
 Anatomische Mikro-Pinzetten..... FC 6
Harrington
 Wundhaken.....RE 26
Hartmann
 Arterienklemmen CF 13
 Hohlmeißelzangen.....BS 46
 Hauthäkchen RE 1, RE 2
 Hautpinzetten..... FC 37
 Hautspreizer.....RE 48
Hayes
 Rektum-Anastomosenklemmen
 AS 18
Heaney
 Nadelhalter WO 11
 Parametriumklemmen GO 39
 Uterusküretten..... GO 55
 Wundhaken.....RE 27
Heaney-Ballentine
 Hysterektomieklammern GO 41
Heaney-Slim
 Parametriumklemmen GO 40
Hegar
 Nadelhalter WO 12
 Uterusdilatoren..... GO 22
Hegar-Baumgartner
 Nadelhalter WO 10, WO 23
Hegar-Vascular
 Nadelhalter WO 29



Hegemann-Diethrich	InstrumentenablageplattenHS7	Julian	NadelhalterWO27
GefäßscherenSC51	InstrumentenkastenHS7, HS8		
Hegenbarth	InstrumentenschalenHS7, HS8	K	
KlammeranlegepinzettenWO52	InzisionsscherenSC21	Kahn	Hakenzangen.....GO26
Heiss	IrisscherenSC11, SC12	Kallmorgen	Scheidenspekula-SetsGO7
Ligaturklemmen.....CF31	Israel	Kalt	Mikro-Nadelhalter.....WO9
Wundspreizer.....RE31	Wundhaken.....RE14	Kalt-Arruga	Mikro-Nadelhalter.....WO9
Henley	Iterson	Kantrowitz	Ligaturklemmen.....CF25
Wundspreizer.....RE39, RE40	Wundhäkchen.....RE6	KanülenTS3-7	
Henning	IUP-Fasszange, flexibel.....GO25	Karabinerhaken.....HS14	
GipsspreizerWO55	Ives-Fansler	Katheter-EinführungsinstrumentAS42	
Henry	Anoskope.....AS23	Katheterzangen.....TS10	
CilienpinzettenFC42		Kaye	Facelift- u. NasenschereSC37
Hey Groves	J	PräparierscherenSC41	
Knochenhaltezeugen.....BS39	Jackson	Kazanjian	KnochensplitterzangenBS58
Heymann	ScheidenspekulaGO7	Kelly	ArterienklemmenCF7, CF23
NasenschereSC47	Wundhäkchen.....RE3, RE5	FistelscherenSC62	
Heywood-Smith	Jacobs	Polypen- u. Ovarienzangen.....GO33	
Hämorrhoidalzangen.....AS26	Hakenzangen.....GO32	ProktoskopeAS23	
Polypen- und Ovarienzangen...GO34	Jacobson	SphinkterskopeAS23	
HF-HandgriffeHF1, HF2	Anatomische Mikro-Pinzetten.....FC5	Wundhaken.....RE22, RE28	
HF-Handgriffe mit integriertem	ArterienklemmenCF12	Kelly-Rankin	ArterienklemmenCF7
Kabel für Elektroden Ø 4 mm und	Mikro-Nadelhalter.....WO4	Kern	Knochenhaltezeugen.....BS38
6-kant Schaft.....HF2	Scharfe LöffelBS15	Kevorkian	BiopsiekürettenGO45
HF-Handgriffe mit integriertem Kabel	Jacobson-Adson	BiopsiezangenGO50	
für Elektroden Ø 4 mm und 6-kant	Feine anatomische PinzettenFC11	Key	ElevatorienBS26
SchaftHF1	Jameson	Kielland	Geburtszangen.....GO64
Hibbs	Feine PräparierscherenSC25	Kilner	HauthäkchenRE1
FlachmeißelBS6	NadelhalterWO13	NadelhalterWO29	
Hohlmeißel.....BS6	Jameson-Werber	PräparierscherenSC38	
OsteotomeBS6	Feine PräparierscherenSC25	Schwedisches ModellSC38	
Wundhaken.....RE27	Janet	Kirschner	BauchdeckenhalterRE60
Hoer	Spritzen.....TS11	Bohrdrähte.....BS67	
ArterienklemmenCF17	Jansen	Führungs-HohlsondenWO48	
RaspatorienBS25	Hohlmeißelzangen.....BS47, BS48	Klammeranlegepinzetten.....WO52	
Hoffmann	Ohrpinzetten.....FC23	Klammeranlege- u. EntfernungszangenWO51
Schlauchklemmen.....CF50	RaspatorienBS19	Klammerzange.....WO51	
HohlmeißelBS1-3, BS5, BS6-8	Scharfe LöffelBS15	Klapp	Sehnenscheidenhaken.....BS87
HohlmeißelzangenBS45-56	Wundspreizer.....RE32	Kleinert-Kutz	Feine Wundhäkchen.....RE2
Hohlsonden.....TS15, TS16	Jansen-Gruenwald	Hohlmeißelzangen.....BS50	
Hohmann	Ohrpinzetten.....FC23	Sehnendurchziehungen.....BS85	
KnochenhebelBS29, BS30	Jarcho	Sehnenscheren.....SC22	
Hohmann-Aldinger	Hakenzangen.....GO28	Kleinschmidt	BlinddarmklemmenAS14
KnochenhebelBS30	Jefferson	Klemmenhalter.....AS17	
Holzbach	Wundspreizer.....RE36		
HysterektomieklemmenGO41	Jobson-Horne		
Hopkins	Watteträger.....TS19		
GipsmesserWO55	Johns-Hopkins		
HornhautschereSC8	Bulldogklemmen.....58		
Hösel	Ligaturklemmen.....CF26		
ScheidenhalterGO19	Joll (Friedmann)		
Wundhaken.....RE19	Schilddrüsen- und Vulvaspreizer		
HudsonRE48		
Bohrapparate.....BS63	Thyreoid- u. Vulvaspreizer.....RE48		
Fräser.....BS63	Jones		
Griff.....BS63	Tuchklemmen45		
Hunt	Joseph		
Mikro-Tumorfasspinzetten.....FC8	PräparierscherenSC38		
Hunter	RaspatorienBS20		
SplitterpinzettenFC40	Judd-Allis		
Hypophysenpinzetten.....FC21	Darm- u. GewebefasszangenAS3		
Hysterektomieklemmen...GO41, GO42	Judd-Masson		
	Blasenwundspreizer.....AS38		
I			
Instrumente für FingernägelBS60			



Klemmzangen CF 40, CF 41
Klima-Rosegger
 Sternal-Punktionskanülen TS 4
 Klängen SK 1, SK 2, SK 3, SK 4
Knapp
 Augenscheren SC 11
 Knochendraht BS 78
 Knochenhaken BS 32–34
 Knochenhalte­zangen BS 36–44
 Knochenhebel BS 28–31
 Knochenraspeln BS 16
 Knochenschere­n SC 75
 Knochensplitter­zangen BS 57–59
Knowles
 Verbandschere­n SC 74
Kocher
 Arterienklemme­n CF 6
 Darmklemme­n AS 12
 Knochenhaken BS 33, BS 34
 Wundhaken RE 16–17, RE 23
Kocher-Atrauma
 Darmklemme­n AS 13
Kocher-Langenbeck
 Wundhaken RE 17
Kocher-Wagner
 Wundhaken RE 17
 Koffer für oszillierende Gipssägen
 WO 57
Kogan
 Endospekula für Cervix GO 23
König
 Elevatorien BS 27
 Führungs-Hohlsonde­n
 WO 49, WO 50
 Raspatorien BS 19
 Kopfschwartenzange­n GO 61
 Korn-(Polypen) Zange­n CF 51
 Kornzangen CF 51–53
Körte
 Wundhaken RE 14
Kristeller
 Scheidenspekula GO 8–12
 Scheidenspekula-Sets GO 8–12
Kronecker
 Unterbindungsnade­ln WO 38
 Kronenschere­n SC 67
Kuehne
 Cilienpinzetten FC 42
L
 Ladegerät für Akku WO 57
La Grange
 Zahnfleis­schsche­ren SC 68
Lahey
 Ligaturklemme­n CF 38
 Wundhaken RE 15
Lambotte
 Knochenhalte­zangen BS 41
 Osteotome BS 4
 Raspatorien BS 18
Landau
 Trokare TS 2
Landolt
 Ohrpinzetten FC 24

Lane
 Chirurgische Pinzetten FC 36
 Knochenhalte­zangen BS 42
 Magen- u. Darm-Zwillingsklemme­n...
 AS 16
 Tuchklemme­n CF 48
Lane-Trethowan
 Knochenhebel BS 30
Langenbeck
 Elevatorien BS 25
 Knochenhalte­zangen BS 37
 Raspatorien BS 18
 Resektionsmes­ser SK 9
 Sägen BS 61
 Wundhaken RE 14–16
Langenbeck-Green
 Wundhaken RE 9, RE 10
 Lateral-Spekulum GO 5
Lawrence
 Ligaturklemme­n 38
Lazar
 Mikro-Nahtpinzetten FC 2
Legueu
 Blasenwundsprei­zer AS 38
Leksell
 Hohlmeißel­zangen BS 55, BS 56
Lempert
 Hohlmeißel­zangen BS 47
Leriche
 Arterienklemme­n CF 9
 Wundhaken RE 27
Lewin
 Knochenhalte­zangen BS 37
Lewkowitz
 Steinzangen AS 40
Lexer
 Hohlmeißel BS 5, BS 7
 Osteotome BS 5
 Präparierschere­n SC 26
Lexer-Fino
 Präparierschere­n SC 26
 Ligaturklemme­n CF 10, CF 25–39
 Ligaturschere­n SC 45, SC 59–60
 Allgemeine Infor­mation SC 45
Lister
 Sinusklemme­n 51
 Verbandschere­n SC 72
Lister-Excentric
 Verbandschere­n SC 73
Liston
 Amputationsmes­ser SK 8
 Knochensplitter­zangen BS 57
Liston-Key-Horsley
 Knochensplitter­zangen BS 59
Littauer
 Ligaturschere­n SC 60
Littauer-Liston
 Knochensplitter­zangen BS 57
Little
 Wundhaken RE 7
Littler
 Ligaturschere­n SC 60
Littlewood
 Darm- und Gewebefass­zangen
 AS 3

Lloyd-Davis
 Rektum-Anastomosenklemme­n
 AS 18
Lockart-Mummary
 Fistelsonde­n TS 17
Locklin
 Zahnfleis­schsche­ren SC 68
Lockwood
 Darm- u. Gewebefass­zangen AS 3
Lockwood-Allis
 Darm- und Gewebefass­zangen
 AS 2
 Löffel scharf BS 9–15
Lorenz
 Verbandschere­n SC 74
Lorna
 Tuchklemme­n CF 47
Loute
 Drahtspanninstu­mente BS 78
Lovelace
 Arterienklemme­n CF 19
Love (Morse)
 Wundhaken RE 7
Lower
 Gallenkanalklemme CF 32
Lowman
 Knochenhalte­zangen BS 44
Lucae
 Ohrpinzetten FC 23
 Hämmer BS 83
Lucas
 Flachmeißel BS 1
 Hohlmeißel BS 1
Luer
 Hohlmeißel­zangen BS 49
 Wundhaken RE 8
Luer-Friedmann
 Hohlmeißel­zangen BS 45
Luer-Koerte
 Gallenkanal Instu­mente AS 34
 Luer-Lock Adapter TS 12
M
Mastercut
 Mastercut Schere­n SC 28, SC 34
 Magenklemme­n AS 14
 Magen- u. Darmquetsch­klemme­n
 AS 15
 Magen- u. Darm- Zwillingsklemme­n
 AS 16
Magill
 Katheterzange­n TS 10
Maingot
 Klemmzange 40
Marham-Meyerding
 Wundsprei­zer RE 49
Marquardt
 Hohlmeißel­zangen BS 52
Martin
 Hakenzange­n GO 26
 Knochenhalte­zangen BS 36
 Wundhaken RE 24
Martini
 Scharfe Löffel BS 15



- Martin (Simpson)**
Uterussonden GO 24
- Masson**
Nadelhalter WO 13, WO 33
- Mathieu**
Fremdkörperzange AS 43
Nadelhalter WO 35–37
Rektum-Spekula AS 21
Wundhaken RE 13
- Mathieu-Kohler**
Nadelhalter WO 36
- Mathieu-Metzenbaum**
Nadelhalter WO 37
- Matzenauer**
Scheidenspekula GO 13
- Mayfield**
Hohlmeißelzangen BS 51
- Mayo**
Fasspinzetten FC 39
Präparierscheren SC 27–29
Sterilisierklammern HS 1
- Mayo-Adams**
Wundspreizer RE 38
- Mayo-Hegar**
Nadelhalter WO 11, WO 22–24
- Mayo-Noble**
Präparierscheren SC 30
- Mayo-Robson**
Darmklemmen AS 9, AS 10
- Mayo-Robson Atrauma**
Darmklemmen AS 11
- Mayo-Stille**
Präparierscheren SC 29, SC 30
- Mc Culloch**
Kanülen TS 7
- Mc Donald**
Elevatorien BS 27
- MC Givney**
Hämorrhoidal-Ligatoren AS 29
Hämorrhoidalzangen AS 27
- Mc Indoe**
Feine anatomische Pinzetten FC 12
Feine chirurgische Pinzetten FC 29
Gefäßscheren SC 49
Knochensplitterzangen BS 58
- Mc Kenzil**
Fräser BS 63
- Mc Lean**
Geburtszangen GO 64
- Mead**
Hämmer BS 84
Hohlmeißelzangen BS 47
Medizinbecher HS 4
- Meeker**
Ligaturklemmen CF 32
Meißel BS 1–3, BS 5
Meißel, Set BS 1
Meniskusmesser BS 35
Messbecher HS 3
Messbecher und Nierenschalen HS 3
Metallkatheter für Frauen AS 41
Metallkatheter für Männer AS 41
Metzenbaum HF 6
Bipolare Scheren HF 6
Präparierscheren SC 28, SC 32–36
Supreme SC 35
- Metzenbaum-Fino**
Präparierscheren SC 31, SC 33
- Metzenbaum-S**
Präparierscheren SC 35
- Meyerdig**
Wundhaken RE 26
Wundspreizer RE 48
- Michel**
Klammeranlegepinzetten WO 52
- Michel Modell**
Klammeranlege- u. Entfernungszangen WO 51
- Micro Adson**
Feine anatomische Pinzetten FC 11
Feine chirurgische Pinzetten FC 25
- Micro-Adson-Biemer**
Feine chirurgische Pinzetten FC 27
- Micro-Mosquito**
Arterienklemmen CF 12
- Micro-Ryder**
Nadelhalter WO 31
- Micro-Semken**
Feine chirurgische Pinzetten FC 28
- Microvascular**
Nadelhalter WO 30
- Middeldorff**
Wundhaken RE 20
- Mikro-Clips 59
- Mikro-Federscheren SC 7–10
- Mikro-Nadelhalter WO 3–9
- Mikro-Nahtpinzetten FC 2–4
- Mikro-Pinzetten, Rundgriff FC 10
- Mikro-Saugkanülen TS 9
- Mikro-Tumorfasspinzetten FC 8, FC 9
- Mikro-Uhrmacher-Pinzetten FC 1
- Mikulicz**
Peritoneumklemmen CF 42, CF 43
Wundhaken RE 28
- Milan**
Biopsie- u. Absaugküretten GO 58
- Miller**
Knochenraspeln BS 16
- Milligan**
Wundspreizer RE 41
- Millin**
Blasenhalsspreizer AS 40
Blasenwundspreizer AS 37
- Mini-Friedmann**
Hohlmeißelzangen BS 45
- Mini-Gemini**
Ligaturklemmen CF 34
- Mini-Hohmann**
Knochenhebel BS 28
- Mini-Klingen-System SK 1
- Minikorb mit Deckel HS 13
- Mini-Lambotte**
Osteotome BS 4
- Mini-Langenbeck**
Wundhäkchen RE 3
- Mini-Lexer**
Hohlmeißel BS 5
Osteotome BS 5
- Mini-Lowman**
Knochenhalte zangen BS 44
- Mini-Townsend-Down**
Uterus-Biopsiezangen GO 53
- Mini-Townsend-Up**
Uterus-Biopsiezangen GO 53
- Mixer**
Ligaturklemmen CF 35, CF 37
- Mixer-Slim**
Ligaturklemmen CF 36
- Modell Rudolf**
Drahtschneidezangen BS 75, BS 76
- Modell USA**
Anatomische Pinzetten FC 20
Chirurgische Pinzetten FC 34
Flachmeißel BS 2
Gipsspreizer WO 56
Hohlmeißel BS 2
Nabelschnurscheren SC 64
Osteotome BS 2
- Modell München**
Biopsieinstrumente GO 44
- Modell Rudolf**
Chirurgische Scheren SC 20
Verbandscheren SC 71
- Mogen**
Beschneidungsinstrumente AS 42
- Mollison**
Wundspreizer RE 36, RE 37
- Molt**
Raspatorien BS 17
- Monopolare Elektroden mit 6-kant Schaft
Ø 2,4 mm HF 3, HF 4
- Monopolare Elektroden mit 6-kant Schaft
Ø 4 mm HF 4
- Morris
Wundhaken RE 19
- Mosquito-Dandy
Arterienklemmen CF 18
- Moynihan
Arterienklemmen CF 16
- Murphy-Lane
Knochenhebel BS 31
- Museum
Hakenzangen GO 31, GO 32
- Myomheber GO 37
- Myrtenblattsonden TS 15
- ## N
- Nabelschnurklemmen GO 62
- Nabelschnurscheren SC 64
- Nadelhalter WO 10–37
- Nadelsauger TS 7
- Nagelausreißzange BS 60
- Nägele**
Geburtszangen GO 64
Perforatorium GO 62
Nagelscheren SC 69
Nagelspaltscheren SC 69
Nagelspaltzange BS 60
Nasenscheren SC 37, SC 47–48
- Negus**
Saug-Dissektoren TS 8
Tonsillenklemmen 40
- Neivert**
Nadelhalter WO 19, WO 20
- Nelaton**
Hohlsonden TS 16



Nelson

Darm- u. Lungenpinzetten FC 38
 Trokare TS 1
 Nerv-Präparierscheren SC 55
 Neurochirurgische Scheren SC 55

New Orleans

Chirurgische Pinzetten FC 36
 Nadelhalter WO 11, WO 21

News

Trachealhäkchen RE 3

New Suture

Chirurgische Scheren SC 21
 Nierenklemmen AS 35
 Nierenschalen HS 3
 Nierensteinzangen AS 36

Nissen

Arterienklemmen CF 20

Northbent

Ligaturscheren SC 60

Noto

Polypen- u. Ovarienzangen GO 34

Novak

Biopsieinstrumente GO 44

Novak-Schoechaert

Biopsieinstrumente GO 44

O

Ochsner

Fadenpinzette FC 20
 Trokare TS 2

Ochsner-Kocher

Arterienklemmen CF 3–5

O' Connor

Feine Wundhäkchen RE 2

Oehler

Feine chirurgische Pinzetten FC 30
 Ohrpinzetten FC 23, FC 24
 Ohrsonde TS 16
 Ohrsonden TS 14

Olivecrona

Hohlmeißelzangen BS 46

Ollier

Wundhaken RE 13

Olsen-Hegar

Nadelhalter WO 15, WO 16

Ombredanne

Hämmer BS 81

O'Shaughnessy

Ligaturklemmen CF 35
 Osteotome BS 1–6

O'Sullivan-O'Connor

Bauchdeckenhalter RE 62
 Ovarienzangen GO 36

Overholt-Geissendörfer

Ligaturklemmen CF 30

Overholt-Mixter

Ligaturklemmen CF 31

Overholt-S

Ligaturklemmen CF 28

Overholt-Slim

Ligaturklemmen CF 28

P

Pacific-Kevorikian

Uterus-Biopsiezangen GO 52

Par

Nadelhalter WO 19
 Parametriumklemmen GO 38–40
 Parametriumscheren SC 66

Park

Anal spreizer AS 24

Parker

Wundhaken RE 12

Parker-Langenbeck

Wundhaken RE 11

Parker-Mott

Wundhaken RE 12

Parsonnet

Wund spreizer RE 32

Partsch

Hämmer BS 84
 Patellazangen BS 43

Patterson

Biopsiezangen GO 49

Payr

Führungs-Hohlsonden WO 46
 Magen- u. Darmquetschklemmen AS 15

Pean

Arterienklemmen CF 6, CF 14
 Trokare TS 2

Peers-Bertram

Tuchklemmen 46

Peet

Splitterzangen FC 41

Pelkmann

Kornzangen 53

Pelteson

Watteträger TS 18

Penderson

Scheidenspekula GO 5
 Penisklemmen AS 43

Pennington

Arterienklemmen CF 14

Percy

Amputationsretractor BS 41
 Perforatorium GO 62
 Peritoneumklemmen CF 42–44

Perkins

Wund spreizer RE 33

Perthes

Reibahlen BS 66

Phaneuf

Hysterektomieklammern GO 41

Piccolo

Watteträger TS 18, TS 19

Piper

Geburtszangen GO 65
 Plazentazangen GO 67

Plester

Wund spreizer RE 34
 Polypen- u. Ovarienzangen GO 33, GO 34

Poole

Kanülen TS 3

Poppen

Kanülen TS 6

Potts-Smith

Feine anatomische Pinzetten FC 18
 Feine chirurgische Pinzetten FC 30
 Gefäßscheren SC 50

Pozzi

Hakenzangen GO 27
 Präparierklemmen CF 35
 Präparierscheren SC 22–36, SC 38–45
 Allgemeine Information SC 45
 Präparierschere mit Fadenbohrung SC 60

Pratt

Fistelsonden TS 17
 Hakenzangen GO 29
 Hämorrhoidalzangen AS 26
 Rektum-Spekula AS 20

Pribram

Mikro-Saugkanülen TS 9
 Proktoskope AS 23
 Propylux, Griffe BS 5, BS 23
 Prostatahaken AS 39

Providence

Arterienklemmen CF 10

Putti

Knochenraspeln BS 16
 Pylorusspreizer AS 14

Q

Quervain

Elevatorien BS 26

R

Radolf

Nagelausreißzange BS 60

Ragnell-Davis

Wundhaken RE 10

Raimondi

Arterienklemmen CF 17

Ralk

Splitterzangen FC 41

Ramplay

Schwammzangen CF 57

Randall

Nierensteinzangen AS 36
 Rasierklingen SK 5
 Rasierklingenbrecher SK 5, SK 6
 Rasierklingenhalter SK 5, SK 6
 Raspatorien BS 17–22, BS 24–25

Recamier

Uterusküretten GO 56, GO 57

Redon

Führungsnadeln TS 13
 Regalwagen HS 17
 Reibahlen BS 66

Reiner

Gipsmesser WO 55
 Rektal-Hohlsonden TS 16
 Rektoskope AS 22, AS 23
 Rektum-Anastomosenklemmen AS 18, AS 19
 Rektum-Biopsiefasszangen AS 25
 Rektum-Spekula AS 20, AS 21



Resano	Rektum-Anastomosenklemmen AS 18	Sänger	Abortus- u. Plazentazangen GO 67	Mikro-Clips CF 59
Resektionsmesser SK 9		Sanvenero	Feine Scheren SC 15	Sedillot
Reverdin	Spatel RE 30	Sarot	Arterienklemmen CF 24	Raspatorien BS 17
Reverdin Nadeln WO 44, WO 45		Nadelhalter WO 32		Sehnen durchziehungen BS 85
Reynolds	Feine Präparierscheren SC 24	Satterlee	Sägen BS 61	Sehnenfasszangen BS 85, BS 86
Präparierscheren SC 39		Sauerbruch	Abfallzange HS 1	Sehnenflecht klemmen BS 86
Ricard	Bauchdeckenhalter RE 53	Wundhaken RE 15	Saug-Dissektoren TS 8	Sehnenhalte zangen BS 86
Richardson	Wundhaken RE 21	Saugkanülen TS 4-7, TS 9	Saug-Raspatorien TS 8	Sehnenscheidenhaken BS 87
Richardson-Eastman	Wundhaken RE 21	Saugrohr, Keramikbeschichtet TS 6	Sawtell	Sehnenscheren SC 7, SC 9, SC 22
Richter-Heath	Klammerzange WO 51	Präparierklemmen CF 35	Schaaß	Seitliches Spekulum GO 19
Rigby	Wundspreizer RE 49	Cilienpinzetten FC 42	Schacke	Sekretlöffel AS 43
Ringgabelschlüssel BS 77		Fasszangen GO 25	Schädel	Seldin
Rippenscheren SC 76		Tuchklemmen CF 45	Tuchklemmen CF 45	Raspatorien BS 19
Roberts	Arterienklemmen CF 22	Schalen HS 5-8	Scharfe Löffel BS 9-15	Sellheim
Rochard	Bauchdeckenhalter RE 64	Scharfe Löffel, Keramikbeschichtet BS 13		Geburtslöffel GO 61
Befestigungsgestell RE 64		Schede	Scharfe Löffel BS 11	Semb
Blätter RE 64		Scheidenhalter GO 19	Scheidenhalter GO 19	Hohlmeißelzangen BS 55
Fixiervorrichtung RE 64		Scheidenspekula GO 1-18, GO 20-21	Scheidenspekula GO 6-12	Knochenhalte zangen BS 39
Rochester-Carmalt	Arterienklemmen CF 18	Scheidenspekula-Sets GO 6-12	Scherbak	Raspatorien BS 21
Rochester-Pean	Arterienklemmen CF 1, CF 2	Scheidenspekula GO 21	Scheidenspekula GO 21	Semken
Rogers	Parametriumklemmen GO 38	Schilddrüsen- u. Vulvaspreizer RE 48	Schilddrüsen- u. Vulvaspreizer RE 48	Feine anatomische Pinzetten FC 12
Ross	Wundhaken RE 29	Schink	Dermatom SK 10	Feine chirurgische Pinzetten FC 28
Röttgen-Ruskin	Hohlmeißelzangen BS 52	Schlauchklemmen CF 49, CF 50	Schlauchklemmen CF 49, CF 50	Semm
Roux	Wundhaken RE 11	Schließzangen AS 17	Schließzangen AS 17	Bauchdeckenhalter RE 59
Rudd	Hämorrhoidal-Ligatoren AS 29	Schmieden	Führungs-Hohlsonden WO 49	Senn-Green
Rudolf	Präparierscheren SC 39	Unterbindungsnadeln WO 42	Unterbindungsnadeln WO 42	Wundhaken RE 10
Rudolf (Schwedisches Modell)	Nadelhalter WO 31	Schmieden-Dick	Unterbindungsnadeln WO 42	Senning
Rumel	Ligaturklemmen CF 26	Schmieden-Payr	Führungs-Hohlsonden WO 49	Nadelhalter WO 14
Runde Behälter HS 4-6		Schneider-Sauerbruch	Raspatorien BS 18	Senn-Mueller
Rundzange BS 60		Schnell-Ladegerät für Akku WO 57	Schnell-Ladegerät für Akku WO 57	Wundhaken RE 9
Ruskin	Hohlmeißelzangen BS 51, BS 52	Schröder	Hakenzangen GO 26, GO 30	Septumbecher HS 4
Ruskin-Liston	Knochensplitterzangen BS 58	Hakenzangen GO 26, GO 30	Uteruslöffel GO 54	Sequesterzangen BS 36
Russisches Modell	Fasspinzetten FC 39	Uteruslöffel GO 54	Schubert	Seutin
Ryder	Nadelhalter WO 30	Biopsiezangen GO 46	Biopsiezangen GO 46	Knochenscheren SC 75
S		Schuknecht	Nadelsauger TS 7	Seziermesser SK 9
Sägeblätter WO 58, BS 61-62		Schultze	Salpingograph GO 59, GO 60	Shortbent
Sägen BS 61, BS 62		Schumacher	Biopsiezangen GO 47, GO 50	Ligaturscheren SC 60
Salpingograph GO 59, GO 60		Nabelschnurscheren SC 64	Nabelschnurscheren SC 64	Siebkorb HS 9, HS 10, HS 11
		Schwammzangen CF 56, CF 57	Schwammzangen CF 56, CF 57	Siebkörbe, Größe 1/1 HS 11
		Schwartz	Anlegezangen CF 59	Siebkörbe, Größe 1/2 HS 9
				Siebkörbe, Größe 3/4 HS 10
				Siebkörbe Größe Mini HS 12
				Siebkörbe, Größe Mini HS 13
				Siebold
				Uterusscheren SC 63
				Silikon-Noppenmatte für Drahtsiebkorb und Siebkorb HS 12
				Silikon-Noppenmatte für Siebkorb HS 9, HS 10, HS 11
				Silver
				Dermatom SK 10
				Simon
				Fistelhaken GO 37
				Uteruslöffel GO 54
				Wundhaken RE 23
				Simpson
				Geburtszangen GO 63
				Simpson-Braun
				Geburtszangen GO 64
				Simpson-Luikart
				Geburtszangen GO 63
				Sims
				Gynäkologische Scheren SC 61
				Rektum-Spekula AS 20, AS 21
				Scheidenspekula-Sets GO 6



Uterusküretten..... GO 56
 Uterussonden GO 24
Sims-Maier
 Kornzangen 53
Singley-Tuttle
 Darm- u. Lungenpinzetten FC 38
 Sinusklemmen CF 51
 Skalpelle..... SK 1–4
Skene
 Hakenzangen..... GO 28
Smillie
 Meniskusmesser BS 35
Smith-Buie
 Analspreizer..... AS 22
Smith-Petersen
 Hohlmeißel..... BS 3
 Hohlmeißelzangen..... BS 53
 Osteotome BS 3
Somer
 Uterusfasszangen GO 35
 Sonden..... TS 14–17
 Sortierspieß..... HS 15
 Spannrahmen für Drahtsiebkorb.....
 HS 9–12
 Spatel RE 30
Spencer
 Ligaturscheren..... SC 59
Spencer-Fino
 Ligaturscheren..... SC 59
Spencer-Wells
 Ligaturklemmen..... CF 39
 Spezialwundspreizer..... RE 48
 Sphinkteroskope..... AS 23
 Spinalhaken BS 35
 Spiralfeder..... HS 15
 Splitterpinzetten..... FC 40
 Splitterzangen..... FC 41
Spratt
 Scharfe Löffel BS 10
 Spritzen..... TS 11
Stacke
 Ohrsonden..... TS 16
Standard
 Anatomische Pinzetten FC 19
Standard Adson
 Feine chirurgische Pinzetten..... FC 26
 Standgefäße..... HS 5
 Staubabsaugung WO 58
 Stechbecken HS 2
Steinmann
 Nägel..... BS 69
 Sehnthaltezangen..... BS 86
 Steinzangen AS 40
Stellbrink
 Hohlmeißelzangen..... BS 45
 Sterilgut-Bereitstellungstische HS 16
 Sterilgut-Regalwagen, geschlossen
 HS 17
 Sterilgut-Regalwagen, offen HS 17
 Sterilisierklammern HS 1
 Sterilisierzangen HS 1
 Sternal-Punktionskanülen TS 4
Stevens
 Sehnenscheren..... SC 22
Stevens-Rudolf
 Sehnenscheren..... SC 22

Stieglitz
 Splitterzangen FC 41
Stille
 Anatomische Pinzetten FC 19
 Bohrapparate..... BS 64
 Flachmeißel BS 6
 Gipsschere WO 56
 Gipsscheren SC 75
 Hohlmeißel..... BS 6
 Hohlmeißelzangen..... BS 56
 Osteotome BS 6
Stille-Barraya
 Chirurgische Pinzetten FC 36
Stille-Liston
 Knochensplitterzangen BS 59
Stille-Luer
 Hohlmeißelzangen..... BS 54
Stille-Ruskin
 Hohlmeißelzangen..... BS 55
St. Marks
 Wundhaken..... RE 18
Stockmann
 Penisklemmen AS 43
 Stößel BS 2
 Strabismusscheren..... SC 23
 Strabismus Scheren SC 13
Strandell-Stille
 Sehnenscheidenhaken..... BS 87
Strassburger Modell
 Chirurgische Pinzetten FC 35
Stratte
 Nadelhalter WO 33
Strauss
 Penisklemmen AS 43
SYME
 Raspatorien BS 21
T
Taylor
 Feine anatomische Pinzetten FC 15
 Feine chirurgische Pinzetten..... FC 32
 Spinalhaken BS 35
Teale
 Hakenzangen..... GO 32
Thomas
 Uterusküretten..... GO 55
Thomas-Gaylor
 Biopsiezangen..... GO 46
Thoms-Allis
 Darm- u. Gewebefasszangen..... AS 3
Tischler
 Biopsiezangen..... GO 47
 Uterus-Biopsiezangen GO 53
Tischler-Morgan
 Biopsiezangen..... GO 51
Tohoku
 Tuchklemmen CF 47
Tönnis
 Tonsillen-Scheren..... SC 56
Tönnis-Adson
 Tonsillen-Scheren..... SC 56
Tönnis-Adson Fino
 Arteriotomie Schere SC 56
 Tonsillenklemmen 40
 Tonsillen-Scheren SC 56, SC 57

Trachealhäkchen..... RE 3–6
Travers
 Wundspreizer..... RE 45
Trélat
 Scheidenspekula..... GO 4
 Trennbleche HS 15
 Trennblechhaltestift HS 15
Treves
 Chirurgische Pinzetten FC 35
Troeltsch
 Ohrpinzetten FC 24
Troeltsch (Wilde)
 Ohrpinzetten FC 24
 Trokare TS 1, TS 2
 Trokar-Set TS 1
Troutman-Chris
 Rasierklingenbrecher SK 5
 Tübinger Modell
 Wundspreizer..... RE 37
 Tuchklammern HS 15
 Tuchklemmen..... CF 45–48
Tuffier
 Arterienklemmen CF 14
 Spatel..... RE 30
 Tupferzangen 54, 55

U

Uffenrode
 Scharfe Löffel BS 12
Ulrich
 Kornzangen 51
Universal
 Sterilisierzangen HS 1
 Trokar-Set TS 1
 Watteträger TS 19
 Unterbindungsnadeln WO 38–43
 Urethrale Bougies AS 41
 Urologie-Instrumente..... AS 39–43
 Uterus-Biopsiezangen GO 52, GO 53
 Uterus-Depressor GO 24
 Uterusdilatatoren GO 22
 Uterusfasszangen..... GO 35, GO 36
 Uterusklemmzangen..... GO 68
 Uterusküretten GO 55–57
 Uteruslöffel..... GO 54
 Uterusscheren SC 63
 Uterus-Sekretlöffel GO 37
 Uterussonden GO 24

V

Vaginalklemmen..... GO 43
Valleix
 Uterussonden GO 24
Van Burren
 Urethrale Bougies..... AS 41
Van Doren
 Biopsiezangen GO 47
Vannas
 Mikro-Federscheren..... SC 7
Vaut
 Polypen- u. Ovarienzangen..... GO 33
 Venae Sectio Besteck..... WO 54
 Venenscheren SC 8



Verbandschere..... SC 71–74

Verbrugge

Knochenhaltezangen.....BS 40

Verbrugge-Müller

KnochenhebelBS 30

Verschlussplomben HS 14

Virchow

SeziermesserSK 9

Vise

Mikro-Uhrmacher-Pinzetten FC 1

Volkmann

Knochenhaken.....BS 32

Scharfe LöffelBS 9, BS 12, BS 14

Wundhäkchen..... RE 6

Vulvaspreizer.....RE 48

W

Wachenfeldt

KlammeranlegepinzettenWO 52

Wagensteen

Nadelhalter WO 13, WO 34

Wagner

Feine chirurgische Scheren SC 17

Waldmann

Damm-(Episiotomie-)Schere...SC 65

Walter-Carmalt

Splitterpinzetten FC 40

Walton

Feine Scheren..... SC 15

Wangensteen

Anatomische Pinzetten FC 21

Watson-Cheyne

ElevatorienBS 27

Sonden TS 14

WattespenderHS 4

Watteträger TS 18–20

Waugh

Feine anatomische Pinzetten FC 13

Feine chirurgische Pinzetten..... FC 30

Webster

Nadelhalter WO 10, WO 20

Weitlaner

Wundspreizer.....RE 35, RE 42

Weitlaner-Baby

Wundspreizer..... RE 41

Weitlaner-Wullstein

Wundspreizer.....RE 36

Wertheim

Gynäkologische ScherenSC 61

Hysterektomieklemmen GO 42

Peritoneumklemmen 42

Wertheim-Cullen

Hysterektomieklemmen GO 42

Westcott

Sehnenscheren.....SC 7, SC 9

Wickstroem

Ligaturklemmen..... CF 37

Williams

Gewebefasszange.....AS 6

Williger

ElevatorienBS 26

HämmerBS 82

RaspatorienBS 19

Scharfe LöffelBS 12, BS 15

Wilmer

Feine PräparierscherenSC 23

Winter

Abortuszangen GO 66

Wolff

GipsabreißzangeWO 56

Wrigley

Geburtszangen..... GO 63

WundhäkchenRE 3–6

Wundhäkchen, fein RE 1, RE 2

Wundhaken RE 7–29

Wundklammern.....WO 51

Wundnahtpinzette.....WO 51

Wundspreizer RE 31–45, RE 47–49

Hemilaminektome-Sperrer..... RE 47

Wylie

Wundhaken..... RE 20

X

Y

Yankauer

RaspatorienBS 25

Yankauer-Standard

Kanülen..... TS 3

Yasargil

Anatomische Mikro-Pinzetten..... FC 5

YASARGIL

Mikro-TumorfasspinzettenFC 9

Yeoman

Rektum-Biopsiefasszangen..... AS 25

Young

ProstatahakenAS 39

Urologie-InstrumenteAS 39

Z

Zahnfleischschere SC 24, SC 68

Zaufal-Jansen

Hohlmeißelzangen..... BS 51

Zenker

Ligaturklemmen.....CF 27

Zubehör.....HS 14, HS 15

Zungenzangen 57



RUDOLF Medical GmbH + Co. KG
Zollerstraße 1, 78567 Fridingen, Germany
Tel +49 7463 9956-0, Fax +49 7463 9956-56
sales@rudolf-med.com, www.rudolf-med.com



Nummernverzeichnis

Numerical Index



CS050-001.....	HS 13	CS956-020.....	HS 15	HF515-020.....	HF 10	HF516-558.....	HF 11
CS050-002.....	HS 13	CS956-021.....	HS 15	HF515-022.....	HF 10	HF516-615.....	HF 11
CS050-003.....	HS 13	CS961-010.....	HS 15	HF515-024.....	HF 10	HF516-618.....	HF 11
CS050-004.....	HS 13	CS961-011.....	HS 15	HF515-055.....	HF 10	HF516-620.....	HF 11
CS050-005.....	HS 13	CS961-012.....	HS 15	HF515-056.....	HF 10	HF516-622.....	HF 11
CS140-000.....	HS 9	CS961-013.....	HS 15	HF515-058.....	HF 10	HF516-624.....	HF 11
CS140-030.....	HS 9	CS961-014.....	HS 15	HF515-059.....	HF 10	HF516-655.....	HF 11
CS140-050.....	HS 9	CS961-015.....	HS 15	HF515-070.....	HF 10	HF516-656.....	HF 11
CS140-070.....	HS 9	CS961-020.....	HS 14	HF515-072.....	HF 10	HF516-658.....	HF 11
CS140-100.....	HS 9	CS961-021.....	HS 14	HF515-115.....	HF 10	HF516-659.....	HF 11
CS141-000.....	HS 9	CS961-030.....	HS 14	HF515-118.....	HF 10	HF518-017.....	HF 8
CS141-041.....	HS 9	CS980-010.....	HS 16	HF515-120.....	HF 10	HF518-117.....	HF 8
CS141-045.....	HS 9	CS980-011.....	HS 16	HF515-122.....	HF 10	HF519-017.....	HF 9
CS141-050.....	HS 9	CS980-012.....	HS 17	HF515-124.....	HF 10	HF519-117.....	HF 9
CS141-070.....	HS 9	CS980-013.....	HS 17	HF515-155.....	HF 10	HF520-017.....	HF 12
CS141-090.....	HS 9	HF300-202.....	HF 6	HF515-156.....	HF 10	HF520-018.....	HF 12
CS141-100.....	HS 9-HS12	HF300-203.....	HF 6	HF515-158.....	HF 10	HF520-020.....	HF 12
CS146-000.....	HS 9	HF300-204.....	HF 6	HF515-159.....	HF 10	HF520-022.....	HF 12
CS147-001.....	HS 9	HF300-205.....	HF 6	HF515-170.....	HF 10	HF520-024.....	HF 12
CS240-000.....	HS 10	HF300-206.....	HF 6	HF515-171.....	HF 10	HF520-058.....	HF 12
CS240-030.....	HS 10	HF300-207.....	HF 6	HF515-172.....	HF 10	HF520-059.....	HF 12
CS240-050.....	HS 10	HF310-103.....	HF 18	HF515-173.....	HF 10	HF520-070.....	HF 12
CS240-070.....	HS 10	HF310-105.....	HF 18	HF515-515.....	HF 10	HF520-071.....	HF 12
CS240-100.....	HS 10	HF310-113.....	HF 18	HF515-518.....	HF 10	HF520-072.....	HF 12
CS241-000.....	HS 10	HF310-115.....	HF 18	HF515-520.....	HF 10	HF520-073.....	HF 12
CS241-041.....	HS 10	HF310-123.....	HF 18	HF515-522.....	HF 10	HF520-074.....	HF 12
CS241-045.....	HS 10	HF310-125.....	HF 18	HF515-524.....	HF 10	HF520-075.....	HF 12
CS241-050.....	HS 10	HF310-133.....	HF 18	HF515-555.....	HF 10	HF520-118.....	HF 12
CS241-070.....	HS 10	HF310-135.....	HF 18	HF515-558.....	HF 10	HF520-120.....	HF 12
CS241-090.....	HS 10	HF310-3031.....	HF 18	HF515-615.....	HF 10	HF520-122.....	HF 12
CS246-000.....	HS 10	HF310-313.....	HF 18	HF515-618.....	HF 10	HF520-124.....	HF 12
CS247-000.....	HS 10	HF310-315.....	HF 18	HF515-620.....	HF 10	HF520-158.....	HF 12
CS340-000.....	HS 11	HF310-323.....	HF 18	HF515-622.....	HF 10	HF520-159.....	HF 12
CS340-030.....	HS 11	HF310-325.....	HF 18	HF515-624.....	HF 10	HF520-170.....	HF 12
CS340-050.....	HS 11	HF310-333.....	HF 18	HF515-655.....	HF 10	HF520-171.....	HF 12
CS340-070.....	HS 11	HF310-335.....	HF 18	HF515-656.....	HF 10	HF520-172.....	HF 12
CS340-100.....	HS 11	HF410-020.....	HF 2	HF515-658.....	HF 10	HF520-173.....	HF 12
CS341-000.....	HS 11	HF410-022.....	HF 2	HF515-659.....	HF 10	HF520-174.....	HF 12
CS341-030.....	HS 11	HF410-024.....	HF 2	HF516-015.....	HF 11	HF520-175.....	HF 12
CS341-050.....	HS 11	HF410-026.....	HF 1	HF516-018.....	HF 11	HF520-418.....	HF 12
CS341-070.....	HS 11	HF410-028.....	HF 1	HF516-020.....	HF 11	HF520-420.....	HF 12
CS341-100.....	HS 11	HF410-030.....	HF 1	HF516-022.....	HF 11	HF520-422.....	HF 12
CS342-000.....	HS 11	HF510-011.....	HF 8	HF516-024.....	HF 11	HF520-424.....	HF 12
CS342-041.....	HS 11	HF510-051.....	HF 8	HF516-055.....	HF 11	HF520-518.....	HF 12
CS342-045.....	HS 11	HF510-111.....	HF 8	HF516-056.....	HF 11	HF520-520.....	HF 12
CS342-050.....	HS 11	HF510-151.....	HF 8	HF516-058.....	HF 11	HF520-522.....	HF 12
CS342-070.....	HS 11	HF510-152.....	HF 8	HF516-059.....	HF 11	HF520-524.....	HF 12
CS342-090.....	HS 11	HF510-211.....	HF 8	HF516-070.....	HF 11	HF520-570.....	HF 12
CS343-000.....	HS 11	HF510-251.....	HF 8	HF516-072.....	HF 11	HF520-572.....	HF 12
CS343-041.....	HS 11	HF510-311.....	HF 8	HF516-115.....	HF 11	HF520-818.....	HF 12
CS343-045.....	HS 11	HF510-351.....	HF 8	HF516-118.....	HF 11	HF520-820.....	HF 12
CS343-050.....	HS 11	HF510-352.....	HF 8	HF516-120.....	HF 11	HF520-822.....	HF 12
CS343-070.....	HS 11	HF510-411.....	HF 8	HF516-122.....	HF 11	HF520-824.....	HF 12
CS343-090.....	HS 11	HF510-511.....	HF 8	HF516-124.....	HF 11	HF520-918.....	HF 12
CS343-180.....	HS 11	HF511-011.....	HF 9	HF516-155.....	HF 11	HF520-920.....	HF 12
CS346-000.....	HS 11	HF511-051.....	HF 9	HF516-156.....	HF 11	HF520-922.....	HF 12
CS347-000.....	HS 11	HF511-111.....	HF 9	HF516-158.....	HF 11	HF520-924.....	HF 12
CS348-000.....	HS 11	HF511-151.....	HF 9	HF516-159.....	HF 11	HF520-970.....	HF 12
CS540-045.....	HS 12	HF511-152.....	HF 9	HF516-170.....	HF 11	HF520-972.....	HF 12
CS546-000.....	HS 12	HF511-211.....	HF 9	HF516-171.....	HF 11	HF 13
CS547-000.....	HS 12	HF511-251.....	HF 9	HF516-172.....	HF 11	HF521-020.....	HF 13
CS950-028.....	HS 14	HF511-311.....	HF 9	HF516-173.....	HF 11	HF521-022.....	HF 13
CS956-001.....	HS 15	HF511-351.....	HF 9	HF516-515.....	HF 11	HF521-024.....	HF 13
CS956-002.....	HS 15	HF511-352.....	HF 9	HF516-518.....	HF 11	HF521-058.....	HF 13
CS956-010.....	HS 15	HF511-411.....	HF 9	HF516-520.....	HF 11	HF521-059.....	HF 13
CS956-011.....	HS 15	HF511-511.....	HF 9	HF516-522.....	HF 11	HF521-070.....	HF 13
CS956-012.....	HS 15	HF515-015.....	HF 10	HF516-524.....	HF 11	HF521-071.....	HF 13
CS956-013.....	HS 15	HF515-018.....	HF 10	HF516-555.....	HF 11	HF521-072.....	HF 13

Nummernverzeichnis

Numerical Index



HF521-073.....	HF 13	HF533-018.....	HF 15	RU 1011-15.....	SC 18	RU 1253-14.....	SC 28
HF521-074.....	HF 13	HF533-020.....	HF 15	RU 1011-16.....	SC 18	RU 1253-17.....	SC 28
HF521-075.....	HF 13	HF533-022.....	HF 15	RU 1011-18.....	SC 18	RU 1253-17M.....	SC 28
HF521-118.....	HF 13	HF533-024.....	HF 15	RU 1011-20.....	SC 18	RU 1253-23.....	SC 29
HF521-120.....	HF 13	HF533-118.....	HF 15	RU 1012-11.....	SC 18	RU 1260-15.....	SC 29
HF521-122.....	HF 13	HF533-120.....	HF 15	RU 1012-13.....	SC 18	RU 1260-15HP.....	SC 29
HF521-124.....	HF 13	HF533-122.....	HF 15	RU 1012-14.....	SC 18	RU 1260-15M.....	SC 29
HF521-158.....	HF 13	HF533-124.....	HF 15	RU 1012-14M.....	SC 18	RU 1260-17.....	SC 29
HF521-159.....	HF 13	HF533-218.....	HF 15	RU 1012-15.....	SC 18	RU 1260-17HP.....	SC 29
HF521-170.....	HF 13	HF533-220.....	HF 15	RU 1012-16.....	SC 18	RU 1260-17M.....	SC 29
HF521-171.....	HF 13	HF533-222.....	HF 15	RU 1012-18.....	SC 18	RU 1261-15.....	SC 30
HF521-172.....	HF 13	HF533-224.....	HF 15	RU 1013-10.....	SC 19	RU 1261-15M.....	SC 30
HF521-173.....	HF 13	HF533-518.....	HF 17	RU 1013-11.....	SC 19	RU 1261-17.....	SC 30
HF521-174.....	HF 13	HF533-520.....	HF 17	RU 1013-13.....	SC 19	RU 1261-17HP.....	SC 30
HF521-175.....	HF 13	HF533-522.....	HF 17	RU 1013-14.....	SC 19	RU 1261-17M.....	SC 30
HF521-418.....	HF 13	HF533-618.....	HF 17	RU 1013-16.....	SC 19	RU 1261-19.....	SC 30
HF521-420.....	HF 13	HF533-620.....	HF 17	RU 1014-14.....	SC 18	RU 1261-21.....	SC 30
HF521-422.....	HF 13	HF533-622.....	HF 17	RU 1016-14.....	SC 18	RU 1262-15.....	SC 29
HF521-424.....	HF 13	HF533-718.....	HF 17	RU 1018-14.....	SC 19	RU 1262-17.....	SC 29
HF521-518.....	HF 13	HF533-720.....	HF 17	RU 1021-14.....	SC 19	RU 1262-17M.....	SC 29
HF521-520.....	HF 13	HF533-722.....	HF 17	RU 1022-14.....	SC 19	RU 1263-15.....	SC 30
HF521-522.....	HF 13	RU 0470-01.....	HF 4	RU 1023-14.....	SC 19	RU 1263-17.....	SC 30
HF521-524.....	HF 13	RU 0470-02.....	HF 4	RU 1031-14.....	SC 19	RU 1263-17M.....	SC 30
HF521-570.....	HF 13	RU 0470-04.....	HF 4	RU 1032-14.....	SC 19	RU 1270-17.....	SC 30
HF521-572.....	HF 13	RU 0470-10.....	HF 4	RU 1033-14.....	SC 19	RU 1270-17HP.....	SC 30
HF521-818.....	HF 13	RU 0470-15.....	HF 4	RU 1040-14.....	SC 20	RU 1271-17.....	SC 30
HF521-820.....	HF 13	RU 0470-17.....	HF 4	RU 1041-14.....	SC 20	RU 1280-11.....	SC 31
HF521-822.....	HF 13	RU 0470-19.....	HF 4	RU 1100-16.....	SC 26	RU 1280-11M.....	SC 31
HF521-824.....	HF 13	RU 0470-51.....	HF 3	RU 1101-16.....	SC 26	RU 1280-49.....	SC 31
HF521-918.....	HF 13	RU 0470-54.....	HF 3	RU 1102-16.....	SC 26	RU 1280-51.....	SC 31
HF521-920.....	HF 13	RU 0470-60.....	HF 3	RU 1103-16.....	SC 26	RU 1281-11.....	SC 31
HF521-922.....	HF 13	RU 0470-65.....	HF 3	RU 1104-16.....	SC 26	RU 1281-11M.....	SC 31
HF521-924.....	HF 13	RU 0470-67.....	HF 3	RU 1105-16.....	SC 26	RU 1281-11S.....	SC 31
HF521-970.....	HF 13	RU 0470-69.....	HF 3	RU 1107-16.....	SC 26	RU 1281-49.....	SC 31
HF521-972.....	HF 13	RU 1000-14.....	SC 20	RU 1110-13.....	SC 21	RU 1281-51.....	SC 31
HF530-018.....	HF 14	RU 1001-10.....	SC 18	RU 1132-14.....	SC 21	RU 1290-14.....	SC 31
HF530-020.....	HF 14	RU 1001-11.....	SC 18	RU 1132-14HP.....	SC 21	RU 1290-14M.....	SC 31
HF530-022.....	HF 14	RU 1001-13.....	SC 18	RU 1250-14.....	SC 27	RU 1291-14.....	SC 31
HF530-118.....	HF 14	RU 1001-14.....	SC 18	RU 1250-14M.....	SC 27	RU 1291-14M.....	SC 31
HF530-120.....	HF 14	RU 1001-15.....	SC 18	RU 1250-14S.....	SC 27	RU 1293-14.....	SC 31
HF530-122.....	HF 14	RU 1001-16.....	SC 18	RU 1250-14S.....	SC 27	RU 1301-14.....	SC 32
HF530-218.....	HF 14	RU 1001-17.....	SC 18	RU 1250-17.....	SC 27	RU 1301-14M.....	SC 32
HF530-220.....	HF 14	RU 1001-18.....	SC 18	RU 1250-17M.....	SC 27	RU 1302-14.....	SC 32
HF530-222.....	HF 14	RU 1001-20.....	SC 18	RU 1250-20.....	SC 27	RU 1303-14.....	SC 32
HF531-018.....	HF 15	RU 1002-10.....	SC 18	RU 1250-20HP.....	SC 27	RU 1304-14.....	SC 32
HF531-020.....	HF 15	RU 1002-11.....	SC 18	RU 1250-23.....	SC 27	RU 1306-14.....	SC 31
HF531-022.....	HF 15	RU 1002-13.....	SC 18	RU 1250-23HP.....	SC 27	RU 1308-14.....	SC 32
HF531-118.....	HF 15	RU 1002-14.....	SC 18	RU 1250-23M.....	SC 27	RU 1311-13.....	SC 32
HF531-120.....	HF 15	RU 1002-14HP.....	SC 18	RU 1251-14.....	SC 28	RU 1311-14.....	SC 32
HF531-122.....	HF 15	RU 1002-14M.....	SC 18	RU 1251-14G.....	SC 28	RU 1311-14G.....	SC 34
HF531-218.....	HF 15	RU 1002-15.....	SC 18	RU 1251-14M.....	SC 28	RU 1311-14M.....	SC 32
HF531-220.....	HF 15	RU 1002-16.....	SC 18	RU 1251-14S.....	SC 28	RU 1311-14S.....	SC 32
HF531-222.....	HF 15	RU 1002-18.....	SC 18	RU 1251-15.....	SC 28	RU 1312-14.....	SC 32
.....	HF 17	RU 1003-10.....	SC 19	RU 1251-17.....	SC 28	RU 1313-14.....	SC 32
HF531-618.....	HF 17	RU 1003-11.....	SC 19	RU 1251-17G.....	SC 28	RU 1314-14.....	SC 32
HF531-718.....	HF 17	RU 1003-13.....	SC 19	RU 1251-17M.....	SC 28	RU 1314-14C.....	SC 32
HF532-018.....	HF 14	RU 1003-14.....	SC 19	RU 1251-20.....	SC 29	RU 1314-14M.....	SC 32
HF532-020.....	HF 14	RU 1003-15.....	SC 19	RU 1251-20HP.....	SC 29	RU 1314-14N.....	SC 32
HF532-022.....	HF 14	RU 1003-16.....	SC 19	RU 1251-23.....	SC 29	RU 1314-14RS.....	SC 45
HF532-024.....	HF 14	RU 1003-18.....	SC 19	RU 1251-23HP.....	SC 29	RU 1314-14RS.....	SC 59
HF532-118.....	HF 14	RU 1003-20.....	SC 19	RU 1251-23M.....	SC 29	RU 1316-14.....	SC 31
HF532-120.....	HF 14	RU 1004-14.....	SC 18	RU 1251-28.....	SC 29	RU 1316-14M.....	SC 31
HF532-122.....	HF 14	RU 1006-14.....	SC 18	RU 1251-28HP.....	SC 29	RU 1318-14.....	SC 31
HF532-124.....	HF 14	RU 1008-14.....	SC 19	RU 1252-14.....	SC 27	RU 1320-18.....	SC 33
HF532-218.....	HF 14	RU 1010-14.....	SC 20	RU 1252-14M.....	SC 27	RU 1320-20.....	SC 33
HF532-220.....	HF 14	RU 1011-11.....	SC 18	RU 1252-17.....	SC 27	RU 1321-18.....	SC 34
HF532-222.....	HF 14	RU 1011-13.....	SC 18	RU 1252-17M.....	SC 27	RU 1321-18M.....	SC 34
HF532-224.....	HF 14	RU 1011-14.....	SC 18	RU 1252-23.....	SC 27	RU 1321-20.....	SC 34

Nummernverzeichnis

Numerical Index



RU 1321-23	SC 36	RU 1414-23.....	SC 61	RU 1675-12.....	SC 38	RU 1773-60R	SC 54
RU 1321-25	SC 36	RU 1415-22	SC 61	RU 1675-12M	SC 38	RU 1773-90R.....	SC 54
RU 1324-18	SC 34	RU 1428-16.....	SC 62	RU 1675-13.....	SC 38	RU 1773-99R.....	SC 54
RU 1324-20	SC 34	RU 1430-16	SC 62	RU 1675-15.....	SC 38	RU 1792-15.....	SC 55
RU 1324-23	SC 36	RU 1430-18	SC 62	RU 1676-11M.....	SC 39	RU 1810-18.....	SC 57
RU 1326-18	SC 33	RU 1430-18HP	SC 62	RU 1676-14M	SC 39	RU 1819-17	SC 56
RU 1326-23	SC 33	RU 1431-16.....	SC 62	RU 1677-13M.....	SC 39	RU 1821-18.....	SC 56
RU 1328-18	SC 35	RU 1441-16.....	SC 62	RU 1680-18M	SC 40	RU 1825-17.....	SC 56
RU 1328-23	SC 35	RU 1445-16	SC 62	RU 1681-18M.....	SC 40	RU 1829-17	SC 56
RU 1330-18	SC 33	RU 1455-24	SC 63	RU 1681-28M	SC 40	RU 1845-19	SC 57
RU 1330-18M	SC 33	RU 1501-12.....	SC 16	RU 1681-78N.....	SC 40	RU 1900-21	SC 58
RU 1330-20	SC 33	RU 1503-12	SC 16	RU 1682-19M	SC 41	RU 1905-21	SC 58
RU 1330-23	SC 33	RU 1503-12HP	SC 16	RU 1683-19M	SC 41	RU 1910-21	SC 58
RU 1330-23M.....	SC 33	RU 1503-12M	SC 16	RU 1685-15M	SC 41	RU 2000-16	SC 64
RU 1330-25	SC 33	RU 1511-12	SC 16	RU 1685-19HP	SC 41	RU 2010-16	SC 64
RU 1330-28	SC 33	RU 1513-12	SC 16	RU 1685-19M	SC 41	RU 2020-10	SC 64
RU 1331-18	SC 34	RU 1513-12HP.....	SC 16	RU 1687-16M.....	SC 42	RU 2050-14	SC 65
RU 1331-18C	SC 34	RU 1513-12M.....	SC 16	RU 1688-19M	SC 42	RU 2055-22.....	SC 65
RU 1331-18G	SC 34	RU 1518-11M	SC 16	RU 1688-29M.....	SC 43	RU 2055-22M.....	SC 65
RU 1331-18M.....	SC 34	RU 1519-11M	SC 16	RU 1688-79N	SC 43	RU 2085-18	SC 65
RU 1331-18N	SC 34	RU 1521-12.....	SC 17	RU 1689-19M	SC 42	RU 2085-18M.....	SC 65
RU 1331-18S	SC 35	RU 1523-12.....	SC 17	RU 1689-29M.....	SC 43	RU 2086-19	SC 65
RU 1331-20	SC 34	RU 1523-12M	SC 17	RU 1689-79N	SC 43	RU 2086-19M.....	SC 65
RU 1331-20G.....	SC 34	RU 1526-12	SC 17	RU 1690-23M.....	SC 43	RU 2087-19.....	SC 65
RU 1331-20M	SC 34	RU 1526-12M	SC 17	RU 1693-18M	SC 44	RU 2090-11	SC 66
RU 1331-23	SC 36	RU 1550-14	SC 17	RU 1705-11	SC 49	RU 2090-14	SC 66
RU 1331-23M	SC 36	RU 1580-15	SC 24	RU 1718-17M.....	SC 49	RU 2115-18.....	SC 47
RU 1331-25	SC 36	RU 1580-15M	SC 24	RU 1720-19.....	SC 50	RU 2115-18M.....	SC 47
RU 1331-25M	SC 36	RU 1581-15	SC 24	RU 1720-19M	SC 50	RU 2125-13M.....	SC 47
RU 1331-28	SC 36	RU 1581-18.....	SC 24	RU 1721-19	SC 50	RU 2129-13.....	SC 47
RU 1331-28M	SC 36	RU 1581-18M.....	SC 24	RU 1721-19M.....	SC 50	RU 2130-13	SC 47
RU 1331-30	SC 36	RU 1582-15M	SC 24	RU 1722-19.....	SC 50	RU 2131-13.....	SC 48
RU 1333-18	SC 35	RU 1583-15	SC 25	RU 1722-19M.....	SC 50	RU 2131-13M.....	SC 48
RU 1333-20	SC 35	RU 1583-15M	SC 25	RU 1730-19.....	SC 49	RU 2132-13	SC 48
RU 1334-18	SC 34	RU 1583-18M	SC 25	RU 1750-16.....	SC 50	RU 2132-13M.....	SC 48
RU 1334-18C.....	SC 34	RU 1584-13	SC 25	RU 1754-16.....	SC 50	RU 2135-16M	SC 48
RU 1334-18M	SC 34	RU 1584-15	SC 25	RU 1754-16HP.....	SC 50	RU 2136-16	SC 48
RU 1334-18N.....	SC 34	RU 1630-09.....	SC 13	RU 1760-19.....	SC 51	RU 2240-11	SC 7
RU 1334-18RS	SC 45	RU 1630-09M.....	SC 13	RU 1760-19M	SC 51	RU 2244-09.....	SC 7
RU 1334-18RS	SC 59	RU 1630-10	SC 13	RU 1761-13.....	SC 51	RU 2252-42	SC 10
RU 1334-18W	SC 34	RU 1630-11	SC 14	RU 1761-16.....	SC 51	RU 2252-43	SC 10
RU 1334-20	SC 34	RU 1630-11M	SC 14	RU 1761-19	SC 51	RU 2253-52.....	SC 10
RU 1334-20C	SC 34	RU 1631-09.....	SC 13	RU 1761-19M.....	SC 51	RU 2253-53.....	SC 10
RU 1334-20M.....	SC 34	RU 1631-09M	SC 13	RU 1762-19.....	SC 51	RU 2253-62.....	SC 10
RU 1334-23	SC 36	RU 1631-10.....	SC 13	RU 1762-19M.....	SC 51	RU 2253-63.....	SC 10
RU 1334-23M	SC 36	RU 1631-11	SC 14	RU 1763-19.....	SC 51	RU 2260-08.....	SC 7
RU 1334-23RS	SC 45	RU 1631-11M	SC 14	RU 1763-19M	SC 51	RU 2261-08.....	SC 7
RU 1334-23RS	SC 59	RU 1632-10.....	SC 13	RU 1764-19.....	SC 51	RU 2330-11	SC 9
RU 1334-25	SC 36	RU 1636-09.....	SC 15	RU 1764-19M	SC 51	RU 2335-11	SC 9
RU 1334-28	SC 36	RU 1638-10	SC 15	RU 1765-19.....	SC 51	RU 2336-11	SC 9
RU 1334-30	SC 36	RU 1640-14	SC 15	RU 1765-19M	SC 51	RU 2338-10	SC 8
RU 1336-18	SC 33	RU 1641-14.....	SC 15	RU 1770-25R.....	SC 53	RU 2339-10	SC 8
RU 1336-18M	SC 33	RU 1650-10	SC 37	RU 1770-45R.....	SC 53	RU 2360-19	SC 10
RU 1336-20	SC 33	RU 1650-10HP	SC 37	RU 1770-60R	SC 53	RU 2361-19.....	SC 10
RU 1336-23	SC 33	RU 1651-10.....	SC 37	RU 1770-90R	SC 53	RU 2370-01	SC 8
RU 1336-23M.....	SC 33	RU 1654-13	SC 37	RU 1770-99R.....	SC 53	RU 2397-01	SC 14
RU 1336-25	SC 33	RU 1655-13	SC 37	RU 1771-25R	SC 53	RU 2404-01.....	SC 11
RU 1336-28	SC 33	RU 1659-61W.....	SC 37	RU 1771-45R.....	SC 53	RU 2404-03.....	SC 11
RU 1338-18	SC 35	RU 1661-11M.....	SC 37	RU 1771-60R.....	SC 53	RU 2405-01.....	SC 11
RU 1338-23	SC 35	RU 1661-61W	SC 37	RU 1771-90R.....	SC 53	RU 2405-03.....	SC 11
RU 1339-18	SC 35	RU 1670-14.....	SC 38	RU 1771-99R.....	SC 53	RU 2406-09.....	SC 13
RU 1382-18.....	SC 46	RU 1670-14HP.....	SC 38	RU 1772-25R.....	SC 54	RU 2406-09M	SC 13
RU 1382-23	SC 46	RU 1670-14M	SC 38	RU 1772-45R.....	SC 54	RU 2406-09N	SC 13
RU 1401-20	SC 61	RU 1671-14	SC 38	RU 1772-60R.....	SC 54	RU 2406-11	SC 14
RU 1401-20M	SC 61	RU 1671-14HP.....	SC 38	RU 1772-90R.....	SC 54	RU 2406-11M	SC 14
RU 1411-20.....	SC 61	RU 1671-14M	SC 38	RU 1772-99R.....	SC 54	RU 2406-11N.....	SC 14
RU 1411-23.....	SC 61	RU 1674-12HP.....	SC 38	RU 1773-25R.....	SC 54	RU 2407-09	SC 13
RU 1414-20.....	SC 61	RU 1674-12M.....	SC 38	RU 1773-45R.....	SC 54	RU 2407-09M.....	SC 13

Nummernverzeichnis

Numerical Index



RU 2407-09N.....	SC 13	RU 2522-11.....	SC 60	RU 3001-22.....	CF 1	RU 3101-21.....	CF 11
RU 2407-11.....	SC 14	RU 2526-11.....	SC 60	RU 3001-24.....	CF 2	RU 3110-12.....	CF 10
RU 2407-11M.....	SC 14	RU 2572-11.....	SC 13	RU 3001-26.....	CF 2	RU 3110-14.....	CF 10
RU 2407-11N.....	SC 14	RU 2598-11.....	SC 13	RU 3001-30.....	CF 2	RU 3110-18.....	CF 11
RU 2416-11.....	SC 14	RU 2600-12.....	SC 70	RU 3010-13.....	CF 3	RU 3110-21.....	CF 11
RU 2418-10.....	SC 14	RU 2600-12HP.....	SC 70	RU 3010-14.....	CF 3	RU 3111-12.....	CF 10
RU 2418-11.....	SC 14	RU 2601-12.....	SC 70	RU 3010-16.....	CF 3	RU 3111-14.....	CF 10
RU 2419-10.....	SC 14	RU 2602-16.....	SC 71	RU 3010-18.....	CF 3	RU 3111-18.....	CF 11
RU 2419-11.....	SC 14	RU 2602-18.....	SC 71	RU 3010-20.....	CF 4	RU 3111-21.....	CF 11
RU 2420-09.....	SC 11	RU 2620-13.....	SC 69	RU 3010-22.....	CF 4	RU 3114-13.....	CF 12
RU 2420-10.....	SC 11	RU 2620-15.....	SC 69	RU 3010-24.....	CF 4	RU 3115-13.....	CF 12
RU 2420-11.....	SC 11	RU 2650-11.....	SC 72	RU 3010-26.....	CF 4	RU 3120-10.....	CF 12
RU 2421-09.....	SC 11	RU 2650-14.....	SC 72	RU 3010-30.....	CF 5	RU 3120-12.....	CF 12
RU 2421-10.....	SC 11	RU 2650-14M.....	SC 72	RU 3011-13.....	CF 3	RU 3121-10.....	CF 12
RU 2421-11.....	SC 11	RU 2650-15.....	SC 72	RU 3011-14.....	CF 3	RU 3121-12.....	CF 12
RU 2422-09.....	SC 11	RU 2650-18.....	SC 72	RU 3011-16.....	CF 3	RU 3122-10.....	CF 12
RU 2422-10.....	SC 11	RU 2650-18M.....	SC 72	RU 3011-18.....	CF 3	RU 3122-12.....	CF 12
RU 2422-11.....	SC 11	RU 2650-20.....	SC 72	RU 3011-20.....	CF 4	RU 3123-10.....	CF 12
RU 2423-09.....	SC 11	RU 2650-20M.....	SC 72	RU 3011-22.....	CF 4	RU 3123-12.....	CF 12
RU 2423-10.....	SC 11	RU 2651-18.....	SC 72	RU 3011-24.....	CF 4	RU 3137-12.....	CF 13
RU 2423-11.....	SC 11	RU 2652-21.....	SC 72	RU 3011-26.....	CF 4	RU 3140-10.....	CF 13
RU 2426-10.....	SC 11	RU 2653-21.....	SC 72	RU 3011-30.....	CF 5	RU 3141-10.....	CF 13
RU 2427-10.....	SC 11	RU 2654-16.....	SC 73	RU 3020-13.....	CF 6	RU 3142-10.....	CF 13
RU 2430-10.....	SC 22	RU 2654-19.....	SC 73	RU 3020-14.....	CF 6	RU 3143-10.....	CF 13
RU 2430-11.....	SC 22	RU 2655-20.....	SC 73	RU 3020-16.....	CF 6	RU 3144-03.....	CF 58
RU 2430-11M.....	SC 22	RU 2655-22.....	SC 73	RU 3021-13.....	CF 6	RU 3144-05.....	CF 58
RU 2431-10.....	SC 22	RU 2660-23.....	SC 73	RU 3021-14.....	CF 6	RU 3144-06.....	CF 58
RU 2431-11.....	SC 22	RU 2665-23.....	SC 74	RU 3021-16.....	CF 6	RU 3145-03.....	CF 58
RU 2431-11M.....	SC 22	RU 2690-24.....	SC 74	RU 3030-13.....	CF 6	RU 3145-05.....	CF 58
RU 2433-12.....	SC 22	RU 2692-24.....	SC 74	RU 3030-14.....	CF 6	RU 3145-06.....	CF 58
RU 2440-10.....	SC 22	RU 2705-14.....	SC 74	RU 3030-16.....	CF 6	RU 3146-01.....	CF 58
RU 2440-10M.....	SC 22	RU 2715-23.....	SC 75	RU 3031-13.....	CF 6	RU 3146-02.....	CF 58
RU 2440-11.....	SC 22	RU 2805-22.....	SC 76	RU 3031-14.....	CF 6	RU 3146-03.....	CF 58
RU 2440-11HP.....	SC 22	RU 2840-23.....	SC 75	RU 3031-16.....	CF 6	RU 3146-04.....	CF 58
RU 2440-11M.....	SC 22	RU 2840-26.....	SC 75	RU 3050-14.....	CF 7	RU 3146-05.....	CF 58
RU 2441-09M.....	SC 22	RU 2840-37.....	SC 75	RU 3050-16.....	CF 7	RU 3146-06.....	CF 58
RU 2441-10.....	SC 22	RU 2870-10.....	SC 67	RU 3051-14.....	CF 7	RU 3146-07.....	CF 58
RU 2441-10M.....	SC 22	RU 2890-12.....	SC 67	RU 3051-16.....	CF 7	RU 3146-11.....	CF 58
RU 2441-11.....	SC 22	RU 2891-12.....	SC 67	RU 3070-14.....	CF 8	RU 3146-12.....	CF 58
RU 2441-11HP.....	SC 22	RU 2900-13.....	SC 24	RU 3070-16.....	CF 8	RU 3146-13.....	CF 58
RU 2441-11M.....	SC 22	RU 2901-13.....	SC 24	RU 3071-14.....	CF 8	RU 3146-14.....	CF 58
RU 2450-08.....	SC 23	RU 2901-13M.....	SC 24	RU 3071-16.....	CF 8	RU 3146-15.....	CF 58
RU 2450-08HP.....	SC 23	RU 2903-13.....	SC 24	RU 3072-14.....	CF 8	RU 3146-16.....	CF 58
RU 2451-08.....	SC 23	RU 2913-17.....	SC 68	RU 3073-14.....	CF 8	RU 3146-17.....	CF 58
RU 2451-08HP.....	SC 23	RU 2918-16.....	SC 68	RU 3074-14.....	CF 8	RU 3147-10.....	CF 13
RU 2455-10.....	SC 23	RU 2932-11.....	SC 68	RU 3074-16.....	CF 8	RU 3148-13.....	CF 13
RU 2457-10.....	SC 23	RU 2940-11.....	SC 68	RU 3075-14.....	CF 8	RU 3149-13.....	CF 14
RU 2458-10.....	SC 23	RU 2940-11HP.....	SC 68	RU 3075-16.....	CF 8	RU 3150-15.....	AS 26
RU 2460-11.....	SC 23	RU 2941-11.....	SC 68	RU 3076-14.....	CF 8	RU 3152-15.....	CF 14
RU 2461-11.....	SC 23	RU 2941-11HP.....	SC 68	RU 3077-14.....	CF 8	RU 3152-20.....	CF 14
RU 2462-11.....	SC 23	RU 2980-10.....	SC 69	RU 3078-14.....	CF 9	RU 3153-14.....	CF 14
RU 2463-11.....	SC 23	RU 2981-10.....	SC 69	RU 3078-16.....	CF 9	RU 3153-16.....	CF 14
RU 2463-11M.....	SC 23	RU 2983-09.....	SC 69	RU 3079-14.....	CF 9	RU 3155-16.....	CF 15
RU 2463-11N.....	SC 23	RU 2983-10.....	SC 69	RU 3079-16.....	CF 9	RU 3156-14.....	CF 15
RU 2476-03.....	SC 12	RU 3000-13.....	CF 1	RU 3080-15.....	CF 9	RU 3157-16.....	CF 15
RU 2477-02.....	SC 12	RU 3000-14.....	CF 1	RU 3081-15.....	CF 9	RU 3159-13.....	CF 15
RU 2477-03.....	SC 12	RU 3000-16.....	CF 1	RU 3082-15.....	CF 9	RU 3160-15.....	BS 85
RU 2478-02.....	SC 12	RU 3000-18.....	CF 1	RU 3083-15.....	CF 9	RU 3160-19.....	BS 85
RU 2480-11.....	SC 12	RU 3000-20.....	CF 1	RU 3090-14.....	CF 10	RU 3160-24.....	BS 85
RU 2500-14.....	SC 60	RU 3000-22.....	CF 1	RU 3091-14.....	CF 10	RU 3161-15.....	BS 85
RU 2510-09.....	SC 59	RU 3000-24.....	CF 2	RU 3097-09.....	CF 10	RU 3161-19.....	BS 85
RU 2510-09HP.....	SC 59	RU 3000-26.....	CF 2	RU 3100-12.....	CF 10	RU 3161-24.....	BS 85
RU 2510-10.....	SC 59	RU 3000-30.....	CF 2	RU 3100-14.....	CF 10	RU 3162-15.....	CF 16
RU 2510-12.....	SC 59	RU 3001-13.....	CF 1	RU 3100-18.....	CF 11	RU 3163-15.....	CF 16
RU 2512-11.....	SC 59	RU 3001-14.....	CF 1	RU 3100-21.....	CF 11	RU 3164-01.....	CF 16
RU 2518-11.....	SC 12	RU 3001-16.....	CF 1	RU 3101-12.....	CF 10	RU 3164-02.....	CF 16
RU 2520-09.....	SC 60	RU 3001-18.....	CF 1	RU 3101-14.....	CF 10	RU 3165-18.....	CF 17
RU 2520-12.....	SC 60	RU 3001-20.....	CF 1	RU 3101-18.....	CF 11	RU 3166-13.....	CF 17

Nummernverzeichnis

Numerical Index



RU 3167-13.....CF 17	RU 3290-23.....CF 28	RU 3383-52.....GO 38	RU 3680-20.....CF 49
RU 3170-16.....CF 18	RU 3290-24.....CF 28	RU 3383-53.....GO 38	RU 3682-14.....CF 49
RU 3170-20.....CF 18	RU 3291-21.....CF 29	RU 3383-54.....GO 38	RU 3684-16.....CF 49
RU 3171-16.....CF 18	RU 3291-27.....CF 30	RU 3384-19.....GO 39	RU 3684-18.....CF 49
RU 3171-20.....CF 18	RU 3292-21.....CF 29	RU 3384-21.....GO 39	RU 3686-15.....CF 50
RU 3179-12.....CF 18	RU 3292-27.....CF 30	RU 3384-23.....GO 39	RU 3686-18.....CF 50
RU 3181-12.....CF 18	RU 3293-21.....CF 29	RU 3384-41.....GO 40	RU 3686-20.....CF 50
RU 3182-14.....CF 18	RU 3293-27.....CF 30	RU 3385-19.....GO 39	RU 3692-13.....CF 50
RU 3183-14.....CF 18	RU 3294-21.....CF 29	RU 3385-21.....GO 39	RU 3692-17.....CF 50
RU 3185-15.....CF 19	RU 3294-27.....CF 30	RU 3385-23.....GO 39	RU 3692-20.....CF 50
RU 3186-16.....CF 19	RU 3295-21.....CF 29	RU 3386-01.....GO 41	RU 3692-25.....CF 50
RU 3187-16.....CF 19	RU 3295-27.....CF 30	RU 3386-11.....GO 41	RU 3692-30.....CF 50
RU 3190-15.....CF 19	RU 3296-21.....CF 29	RU 3387-01.....CF 40	RU 3692-40.....CF 50
RU 3190-18.....CF 19	RU 3296-27.....CF 30	RU 3387-02.....CF 40	RU 3800-22.....CF 51
RU 3191-15.....CF 19	RU 3297-21.....CF 29	RU 3388-20.....GO 41	RU 3800-25.....CF 51
RU 3191-18.....CF 19	RU 3297-27.....CF 30	RU 3389-20.....GO 41	RU 3800-27.....CF 51
RU 3198-19.....CF 20	RU 3298-21.....CF 31	RU 3390-16.....AS 26	RU 3801-22.....CF 51
RU 3200-18.....CF 20	RU 3301-20.....CF 31	RU 3391-16.....AS 26	RU 3801-25.....CF 51
RU 3201-18.....CF 20	RU 3302-20.....CF 31	RU 3392-21.....CF 40	RU 3801-27.....CF 51
RU 3204-18.....CF 20	RU 3303-20.....CF 31	RU 3394-20.....CF 40	RU 3810-12.....CF 51
RU 3204-22.....CF 20	RU 3305-20.....CF 31	RU 3394-25.....CF 40	RU 3810-16.....CF 51
RU 3205-14.....CF 20	RU 3306-20.....CF 31	RU 3401-23.....AS 31	RU 3810-18.....CF 51
RU 3205-18.....CF 20	RU 3308-27.....CF 32	RU 3401-24.....AS 31	RU 3812-13.....CF 51
RU 3210-19.....CF 22	RU 3325-18.....CF 32	RU 3420-23.....GO 41	RU 3860-20.....CF 52
RU 3211-19.....CF 22	RU 3326-13.....CF 33	RU 3421-23.....GO 41	RU 3860-25.....CF 52
RU 3240-20.....CF 21	RU 3326-18.....CF 33	RU 3426-14.....GO 61	RU 3861-20.....CF 52
RU 3240-22.....CF 21	RU 3326-20.....CF 33	RU 3430-25.....GO 42	RU 3861-25.....CF 52
RU 3240-24.....CF 21	RU 3326-23.....CF 33	RU 3432-21.....GO 42	RU 3862-20.....CF 52
RU 3240-26.....CF 21	RU 3326-25.....CF 33	RU 3433-24.....GO 42	RU 3862-25.....CF 52
RU 3241-20.....CF 21	RU 3326-27.....CF 33	RU 3433-45.....CF 41	RU 3863-20.....CF 52
RU 3241-22.....CF 21	RU 3327-18.....CF 34	RU 3434-01.....GO 43	RU 3863-25.....CF 52
RU 3241-24.....CF 21	RU 3327-22.....CF 34	RU 3434-02.....GO 43	RU 3872-25.....CF 53
RU 3241-26.....CF 21	RU 3327-25.....CF 34	RU 3435-22.....GO 42	RU 3873-25.....CF 53
RU 3250-22.....CF 22	RU 3327-28.....CF 34	RU 3436-22.....GO 42	RU 3874-28.....CF 53
RU 3251-22.....CF 22	RU 3328-01.....CF 34	RU 3438-18.....CF 42	RU 3875-28.....CF 53
RU 3253-41.....CF 23	RU 3328-14.....CF 34	RU 3492-14.....CF 42	RU 3887-25.....CF 54
RU 3253-42.....CF 23	RU 3328-18.....CF 34	RU 3500-18.....CF 42	RU 3888-25.....CF 54
RU 3253-43.....CF 23	RU 3329-01.....CF 35	RU 3500-20.....CF 42	RU 3889-21.....CF 54
RU 3253-61.....CF 23	RU 3330-15.....CF 35	RU 3501-20.....CF 43	RU 3890-26.....CF 54
RU 3253-62.....CF 23	RU 3330-19.....CF 35	RU 3502-18.....CF 43	RU 3891-26.....CF 55
RU 3253-63.....CF 23	RU 3335-15.....CF 35	RU 3504-18.....CF 43	RU 3893-26.....CF 55
RU 3253-71.....CF 23	RU 3335-19.....CF 35	RU 3505-20.....CF 43	RU 3896-18.....CF 57
RU 3253-72.....CF 23	RU 3336-18.....CF 36	RU 3506-20.....CF 43	RU 3896-25.....CF 57
RU 3253-73.....CF 23	RU 3336-23.....CF 36	RU 3511-20.....CF 44	RU 3900-18.....CF 56
RU 3270-24.....CF 24	RU 3341-22.....CF 36	RU 3512-20.....CF 44	RU 3900-25.....CF 56
RU 3271-24.....CF 24	RU 3342-25.....CF 36	RU 3550-09.....CF 45	RU 3901-18.....CF 56
RU 3275-18.....CF 25	RU 3343-28.....CF 36	RU 3552-05.....CF 45	RU 3901-25.....CF 56
RU 3275-24.....CF 25	RU 3350-22.....CF 37	RU 3552-09.....CF 45	RU 3910-18.....CF 56
RU 3279-19.....CF 25	RU 3351-20.....CF 37	RU 3553-09.....CF 45	RU 3910-25.....CF 56
RU 3279-24.....CF 25	RU 3352-24.....CF 37	RU 3600-09.....CF 46	RU 3911-18.....CF 56
RU 3279-26.....CF 25	RU 3355-27.....CF 38	RU 3600-11.....CF 46	RU 3911-25.....CF 56
RU 3280-01.....CF 26	RU 3361-19.....CF 38	RU 3600-13.....CF 46	RU 3930-01.....CF 59
RU 3280-02.....CF 26	RU 3361-23.....CF 38	RU 3600-15.....CF 46	RU 3930-02.....CF 59
RU 3280-03.....CF 26	RU 3380-13.....CF 39	RU 3602-11.....CF 46	RU 3930-03.....CF 59
RU 3280-04.....CF 26	RU 3380-14.....CF 39	RU 3602-13.....CF 46	RU 3930-80.....CF 59
RU 3280-05.....CF 26	RU 3380-15.....CF 39	RU 3604-14.....CF 46	RU 3932-00.....CF 60
RU 3285-20.....CF 26	RU 3380-18.....CF 39	RU 3605-10.....CF 47	RU 3932-04.....CF 60
RU 3286-00.....CF 27	RU 3380-20.....CF 39	RU 3605-13.....CF 47	RU 3932-08.....CF 60
RU 3286-01.....CF 27	RU 3381-13.....CF 39	RU 3617-11.....CF 47	RU 3932-10.....CF 60
RU 3286-02.....CF 27	RU 3381-14.....CF 39	RU 3617-13.....CF 47	RU 3932-14.....CF 60
RU 3289-14.....CF 27	RU 3381-15.....CF 39	RU 3618-10.....CF 47	RU 3932-18.....CF 60
RU 3290-01.....CF 28	RU 3381-18.....CF 39	RU 3618-13.....CF 47	RU 3934-08.....CF 60
RU 3290-02.....CF 28	RU 3381-20.....CF 39	RU 3620-16.....CF 48	RU 3934-12.....CF 60
RU 3290-03.....CF 28	RU 3383-01.....GO 38	RU 3622-13.....CF 48	RU 3934-16.....CF 60
RU 3290-04.....CF 28	RU 3383-02.....GO 38	RU 3622-15.....CF 48	RU 3934-60.....CF 61
RU 3290-05.....CF 28	RU 3383-03.....GO 38	RU 3622-20.....CF 48	RU 3934-64.....CF 61
RU 3290-21.....CF 28	RU 3383-04.....GO 38	RU 3680-15.....CF 49	RU 3934-70.....CF 61
RU 3290-22.....CF 28	RU 3383-51.....GO 38	RU 3680-18.....CF 49	RU 3934-71.....CF 61

Nummernverzeichnis

Numerical Index



RU 3935-08.....	CF 60	RU 4022-12	FC 20	RU 4068-19T	FC 3	RU 4079-34T.....	FC 10
RU 3935-12	CF 60	RU 4022-13	FC 20	RU 4068-21	FC 3	RU 4079-36.....	FC 10
RU 3935-16	CF 60	RU 4022-14	FC 20	RU 4068-22U	FC 3	RU 4079-36G.....	FC 10
RU 3935-21	CF 60	RU 4022-15	FC 20	RU 4068-32.....	FC 3	RU 4079-36T.....	FC 10
RU 3935-60.....	CF 61	RU 4026-15	FC 37	RU 4068-42.....	FC 3	RU 4079-36U.....	FC 10
RU 3935-64.....	CF 61	RU 4030-12	FC 2	RU 4068-42T.....	FC 3	RU 4079-37G.....	FC 10
RU 3935-70.....	CF 61	RU 4032-12	FC 11	RU 4068-44.....	FC 3	RU 4079-38.....	FC 10
RU 3936-20.....	CF 59	RU 4033-12	FC 11	RU 4068-44T.....	FC 3	RU 4079-38T.....	FC 10
RU 3936-30.....	CF 59	RU 4033-15	FC 11	RU 4068-46.....	FC 3	RU 4079-42G.....	FC 10
RU 3979-36.....	CF 9	RU 4034-12	FC 11	RU 4068-51G.....	FC 3	RU 4079-43G.....	FC 10
RU 4000-10.....	FC 19	RU 4034-15	FC 11	RU 4068-52G.....	FC 3	RU 4079-46G.....	FC 10
RU 4000-11.....	FC 19	RU 4035-12	FC 11	RU 4068-53G.....	FC 3	RU 4079-47G.....	FC 10
RU 4000-13.....	FC 19	RU 4035-15	FC 11	RU 4068-54G.....	FC 3	RU 4079-52.....	FC 10
RU 4000-14.....	FC 19	RU 4035-32.....	FC 11	RU 4068-55G.....	FC 3	RU 4079-54.....	FC 10
RU 4000-15.....	FC 19	RU 4035-52.....	FC 2	RU 4068-56G.....	FC 3	RU 4079-56.....	FC 10
RU 4000-16.....	FC 19	RU 4036-12	FC 11	RU 4068-63G.....	FC 3	RU 4079-58.....	FC 10
RU 4000-18.....	FC 19	RU 4036-15	FC 11	RU 4068-74G.....	FC 10	RU 4080-17.....	FC 16
RU 4000-20.....	FC 19	RU 4038-15	FC 12	RU 4068-75G.....	FC 10	RU 4081-17.....	FC 16
RU 4000-25.....	FC 19	RU 4039-15	FC 12	RU 4068-82.....	FC 4	RU 4082-17	FC 16
RU 4000-30.....	FC 19	RU 4040-12	FC 12	RU 4068-85.....	FC 4	RU 4082-27	FC 16
RU 4001-11.....	FC 19	RU 4040-15	FC 12	RU 4068-88.....	FC 4	RU 4083-17	FC 16
RU 4001-13.....	FC 19	RU 4041-12.....	FC 12	RU 4068-95.....	FC 4	RU 4084-18	FC 18
RU 4001-14.....	FC 19	RU 4041-15.....	FC 12	RU 4069-12.....	FC 3	RU 4085-15.....	FC 21
RU 4001-16.....	FC 19	RU 4042-15	FC 12	RU 4069-15.....	FC 3	RU 4085-23.....	FC 21
RU 4001-18	FC 19	RU 4048-18	FC 13	RU 4069-18.....	FC 3	RU 4085-25.....	FC 21
RU 4001-20.....	FC 19	RU 4050-17	FC 15	RU 4069-18T.....	FC 3	RU 4086-23.....	FC 21
RU 4001-25.....	FC 19	RU 4051-17.....	FC 15	RU 4069-19.....	FC 3	RU 4090-18.....	FC 18
RU 4001-30.....	FC 19	RU 4052-17.....	FC 15	RU 4069-19T.....	FC 3	RU 4090-21.....	FC 18
RU 4002-14.....	FC 19	RU 4053-17.....	FC 15	RU 4069-21.....	FC 3	RU 4090-25.....	FC 18
RU 4002-16.....	FC 19	RU 4054-17	FC 15	RU 4069-22U	FC 3	RU 4091-18	FC 18
RU 4002-18	FC 19	RU 4054-20.....	FC 15	RU 4069-82.....	FC 4	RU 4091-21	FC 18
RU 4002-20.....	FC 19	RU 4055-15.....	FC 13	RU 4069-85.....	FC 4	RU 4091-25	FC 18
RU 4002-25.....	FC 19	RU 4055-18.....	FC 13	RU 4069-88.....	FC 4	RU 4092-15	FC 18
RU 4010-11.....	FC 19	RU 4055-20.....	FC 13	RU 4069-95.....	FC 4	RU 4092-18	FC 18
RU 4010-13.....	FC 19	RU 4056-18.....	FC 13	RU 4070-17	FC 14	RU 4092-20.....	FC 18
RU 4010-14.....	FC 19	RU 4056-20.....	FC 13	RU 4070-17T.....	FC 14	RU 4092-23.....	FC 18
RU 4010-16	FC 19	RU 4057-20.....	FC 17	RU 4070-57	FC 14	RU 4092-25.....	FC 18
RU 4010-18	FC 19	RU 4058-20.....	FC 17	RU 4071-17.....	FC 14	RU 4095-00.....	FC 24
RU 4010-20.....	FC 19	RU 4059-18	FC 20	RU 4071-59.....	FC 14	RU 4100-10.....	FC 33
RU 4010-25.....	FC 19	RU 4060-20.....	FC 17	RU 4075-00.....	FC 2	RU 4100-11.....	FC 33
RU 4010-30.....	FC 19	RU 4061-20.....	FC 17	RU 4075-05	FC 2	RU 4100-13.....	FC 33
RU 4011-11.....	FC 19	RU 4063-22.....	FC 5	RU 4075-08.....	FC 2	RU 4100-14.....	FC 33
RU 4011-13.....	FC 19	RU 4063-24.....	FC 5	RU 4075-14	FC 2	RU 4100-15.....	FC 33
RU 4011-14.....	FC 19	RU 4063-32.....	FC 5	RU 4075-18	FC 2	RU 4100-16.....	FC 33
RU 4011-16.....	FC 19	RU 4063-34.....	FC 5	RU 4078-01	FC 8	RU 4100-18.....	FC 33
RU 4011-18.....	FC 19	RU 4063-36.....	FC 5	RU 4078-02.....	FC 8	RU 4100-20.....	FC 33
RU 4011-20.....	FC 19	RU 4063-42.....	FC 5	RU 4078-03.....	FC 8	RU 4100-25.....	FC 33
RU 4011-25.....	FC 19	RU 4063-44.....	FC 5	RU 4078-04.....	FC 8	RU 4100-30.....	FC 33
RU 4011-30	FC 19	RU 4063-52.....	FC 5	RU 4078-05.....	FC 8	RU 4101-14.....	FC 30
RU 4013-13.....	FC 19	RU 4063-54.....	FC 5	RU 4078-06.....	FC 8	RU 4101-16.....	FC 30
RU 4013-15.....	FC 19	RU 4063-62.....	FC 5	RU 4078-06.....	FC 8	RU 4101-18.....	FC 30
RU 4013-17.....	FC 19	RU 4063-64.....	FC 5	RU 4078-10	FC 8	RU 4101-20.....	FC 30
RU 4013-20.....	FC 19	RU 4064-51.....	FC 9	RU 4078-11.....	FC 8	RU 4101-20.....	FC 30
RU 4015-11.....	FC 20	RU 4064-52.....	FC 9	RU 4078-16	FC 5	RU 4101-25.....	FC 30
RU 4015-13	FC 20	RU 4064-54.....	FC 9	RU 4078-20	FC 21	RU 4101-30	FC 30
RU 4015-14.....	FC 20	RU 4064-55.....	FC 9	RU 4078-25.....	FC 6	RU 4102-13.....	FC 34
RU 4015-15	FC 20	RU 4064-57.....	FC 9	RU 4078-30G.....	FC 7	RU 4102-14.....	FC 34
RU 4015-16	FC 20	RU 4064-58.....	FC 9	RU 4078-31G.....	FC 7	RU 4102-16.....	FC 34
RU 4015-18	FC 20	RU 4064-61.....	FC 9	RU 4078-40G.....	FC 7	RU 4102-18.....	FC 34
RU 4015-20.....	FC 20	RU 4064-62.....	FC 9	RU 4078-41G.....	FC 7	RU 4102-20.....	FC 34
RU 4020-12	FC 20	RU 4064-63.....	FC 9	RU 4078-60.....	FC 8	RU 4102-25	FC 34
RU 4020-13	FC 20	RU 4065-15	FC 5	RU 4079-12	FC 10	RU 4102-30	FC 34
RU 4020-14	FC 20	RU 4065-18	FC 5	RU 4079-12U.....	FC 10	RU 4103-13.....	FC 34
RU 4020-15.....	FC 20	RU 4068-12	FC 3	RU 4079-14	FC 10	RU 4103-14.....	FC 34
RU 4020-18	FC 20	RU 4068-15.....	FC 3	RU 4079-16U.....	FC 10	RU 4103-16.....	FC 34
RU 4020-21.....	FC 20	RU 4068-18	FC 3	RU 4079-32G.....	FC 10	RU 4103-20.....	FC 34
RU 4020-25.....	FC 20	RU 4068-18T.....	FC 3	RU 4079-32T.....	FC 10	RU 4104-13.....	FC 34
RU 4020-30.....	FC 20	RU 4068-19.....	FC 3	RU 4079-32U.....	FC 10	RU 4104-14.....	FC 34
				RU 4079-33G.....	FC 10	RU 4104-16.....	FC 34

Nummernverzeichnis

Numerical Index



RU 4109-16.....	FC33	RU 4140-30	FC28	RU 4240-04.....	FC1	RU 4380-09.....	FC42
RU 4110-11	FC33	RU 4140-31	FC28	RU 4240-05.....	FC1	RU 4382-09.....	FC42
RU 4110-13	FC33	RU 4141-12	FC28	RU 4240-06.....	FC1	RU 4386-09.....	FC42
RU 4110-14	FC33	RU 4141-15	FC28	RU 4240-07	FC1	RU 4390-10	FC42
RU 4110-16	FC33	RU 4142-12.....	FC28	RU 4240-08.....	FC1	RU 4392-10	FC42
RU 4110-18	FC33	RU 4142-15.....	FC28	RU 4241-01	FC1	RU 4425-20	RE1
RU 4110-20.....	FC33	RU 4144-15.....	FC36	RU 4241-02	FC1	RU 4426-01	RE1
RU 4110-25.....	FC33	RU 4144-20	FC36	RU 4241-03	FC1	RU 4426-02.....	RE1
RU 4111-14	FC33	RU 4144-25	FC36	RU 4242-01	FC1	RU 4426-11	RE1
RU 4120-12.....	FC34	RU 4145-15.....	FC36	RU 4250-10	FC12	RU 4426-12	RE1
RU 4120-13.....	FC34	RU 4145-20	FC36	RU 4251-10	FC12	RU 4430-10	RE3
RU 4120-14.....	FC34	RU 4145-25	FC36	RU 4252-10.....	FC12	RU 4430-17	RE3
RU 4120-15.....	FC34	RU 4147-01.....	FC27	RU 4260-10	FC25	RU 4430-20.....	RE3
RU 4120-18.....	FC34	RU 4147-02.....	FC27	RU 4261-10.....	FC25	RU 4430-22.....	RE3
RU 4120-21	FC34	RU 4147-03.....	FC27	RU 4262-10	FC25	RU 4430-51	RE2
RU 4120-25	FC34	RU 4148-18.....	FC29	RU 4270-05.....	FC40	RU 4430-52.....	RE2
RU 4120-31	FC34	RU 4150-17.....	FC32	RU 4270-15.....	FC40	RU 4430-53.....	RE2
RU 4122-12	FC34	RU 4151-17	FC32	RU 4290-08.....	FC40	RU 4430-54.....	RE2
RU 4122-13.....	FC34	RU 4152-17.....	FC32	RU 4290-09.....	FC40	RU 4430-70.....	RE2
RU 4122-14.....	FC34	RU 4154-17.....	FC32	RU 4290-10	FC40	RU 4435-03.....	RE2
RU 4122-18.....	FC34	RU 4154-20	FC32	RU 4290-11	FC40	RU 4435-05.....	RE2
RU 4122-21.....	FC34	RU 4155-15.....	FC30	RU 4290-12	FC40	RU 4435-07.....	RE2
RU 4122-25	FC34	RU 4155-18.....	FC30	RU 4291-08.....	FC40	RU 4436-01.....	RE2
RU 4122-31	FC34	RU 4155-20	FC30	RU 4291-09.....	FC40	RU 4436-02.....	RE2
RU 4123-14.....	FC34	RU 4155-25	FC30	RU 4291-10.....	FC40	RU 4439-17	RE3
RU 4126-13.....	FC34	RU 4155-30	FC30	RU 4291-11.....	FC40	RU 4440-15	RE3
RU 4126-14.....	FC34	RU 4160-20	FC31	RU 4291-12.....	FC40	RU 4454-18	RE3
RU 4126-15.....	FC34	RU 4161-20.....	FC31	RU 4292-08.....	FC40	RU 4454-20.....	RE3
RU 4128-13.....	FC35	RU 4170-18.....	FC31	RU 4292-09.....	FC40	RU 4454-23.....	RE3
RU 4130-12.....	FC25	RU 4171-18.....	FC31	RU 4292-10	FC40	RU 4455-20	RE7
RU 4130-15.....	FC25	RU 4171-59.....	FC31	RU 4292-11.....	FC40	RU 4456-10	RE7
RU 4130-22	FC25	RU 4180-17.....	FC30	RU 4292-12	FC40	RU 4456-15	RE7
RU 4130-25	FC25	RU 4181-17	FC30	RU 4293-08.....	FC40	RU 4456-20.....	RE7
RU 4130-32	FC11	RU 4190-18.....	FC30	RU 4293-09.....	FC40	RU 4456-30.....	RE7
RU 4131-12.....	FC27	RU 4190-21	FC30	RU 4293-10	FC40	RU 4456-40.....	RE7
RU 4132-12.....	FC26	RU 4190-25	FC30	RU 4293-11	FC40	RU 4456-50.....	RE7
RU 4133-01	FC25	RU 4191-18.....	FC30	RU 4293-12	FC40	RU 4456-81.....	RE7
RU 4133-02	FC25	RU 4191-21.....	FC30	RU 4296-01.....	FC6	RU 4456-82.....	RE7
RU 4133-03	FC25	RU 4191-25.....	FC30	RU 4296-02.....	FC6	RU 4456-83.....	RE7
RU 4133-04.....	FC25	RU 4215-14.....	FC38	RU 4296-06.....	FC6	RU 4460-01.....	RE4
RU 4133-10.....	FC25	RU 4216-20.....	FC38	RU 4300-43.....	HF8	RU 4460-02.....	RE4
RU 4134-12.....	FC26	RU 4219-14.....	FC39	RU 4302-46.....	HF16	RU 4460-03.....	RE4
RU 4134-15.....	FC26	RU 4219-16.....	FC39	RU 4302-52.....	HF16	RU 4460-04.....	RE4
RU 4135-12.....	FC26	RU 4219-20	FC39	RU 4302-55.....	HF16	RU 4461-01	RE4
RU 4135-15.....	FC26	RU 4220-15	FC39	RU 4302-57.....	HF16	RU 4461-02	RE4
RU 4135-52	FC26	RU 4220-20.....	FC39	RU 4302-76	HF17	RU 4461-03.....	RE4
RU 4135-55	FC26	RU 4220-25.....	FC39	RU 4302-82	HF17	RU 4461-04.....	RE4
RU 4135-72	FC26	RU 4221-23	FC39	RU 4320-07.....	FC40	RU 4462-01	RE4
RU 4135-82	FC27	RU 4224-15	FC35	RU 4320-09.....	FC40	RU 4462-02.....	RE4
RU 4136-12.....	FC26	RU 4224-20	FC35	RU 4320-11	FC40	RU 4462-03.....	RE4
RU 4136-72	FC27	RU 4225-18	FC35	RU 4340-10	FC40	RU 4462-04.....	RE4
RU 4137-12	FC37	RU 4225-28	FC35	RU 4341-10.....	FC40	RU 4463-01.....	RE4
RU 4137-15.....	FC37	RU 4225-52.....	FC35	RU 4350-10.....	FC40	RU 4463-02.....	RE4
RU 4137-62.....	FC37	RU 4226-14	FC36	RU 4351-10.....	FC40	RU 4463-03.....	RE4
RU 4137-72.....	FC37	RU 4226-20.....	FC36	RU 4358-11	FC41	RU 4463-04.....	RE4
RU 4137-82.....	FC37	RU 4227-14.....	FC36	RU 4359-13	FC41	RU 4464-01.....	RE5
RU 4138-15.....	FC29	RU 4227-20	FC36	RU 4360-13	FC41	RU 4464-02.....	RE5
RU 4138-15T.....	FC29	RU 4228-18	FC36	RU 4361-13.....	FC41	RU 4464-03.....	RE5
RU 4138-65	FC29	RU 4228-20.....	FC36	RU 4362-13	FC41	RU 4464-04.....	RE5
RU 4138-75	FC29	RU 4228-25	FC36	RU 4364-15	FC41	RU 4465-01.....	RE5
RU 4139-15.....	FC37	RU 4229-18	FC36	RU 4365-15	FC41	RU 4465-02.....	RE5
RU 4139-20	FC37	RU 4230-18	FC36	RU 4368-14	FC20	RU 4465-03.....	RE5
RU 4139-25	FC37	RU 4235-15	FC38	RU 4371-12.....	FC42	RU 4465-04.....	RE5
RU 4140-12.....	FC28	RU 4235-18	FC38	RU 4372-09.....	FC42	RU 4466-01.....	RE5
RU 4140-15.....	FC28	RU 4235-23	FC38	RU 4373-10	FC42	RU 4466-02.....	RE5
RU 4140-24	FC28	RU 4236-18	FC38	RU 4375-09.....	FC42	RU 4468-13	RE5
RU 4140-26	FC28	RU 4236-23.....	FC38	RU 4376-11.....	FC42	RU 4469-14	RE5
RU 4140-28	FC28	RU 4240-03.....	FC1	RU 4380-08.....	FC42	RU 4471-01	RE6

Nummernverzeichnis

Numerical Index



RU 4471-02	RE 6	RU 4500-04.....	BS 32	RU 4537-21	RE 17	RU 4554-03.....	RE 22
RU 4472-02	RE 6	RU 4500-06.....	BS 32	RU 4538-11	RE 17	RU 4554-50.....	RE 22
RU 4472-03	RE 6	RU 4500-08.....	BS 32	RU 4538-12	RE 17	RU 4554-51.....	RE 22
RU 4472-04	RE 6	RU 4501-01.....	BS 32	RU 4538-13	RE 17	RU 4554-52.....	RE 22
RU 4472-06	RE 6	RU 4501-02.....	BS 32	RU 4538-14	RE 17	RU 4554-53.....	RE 22
RU 4473-02.....	RE 6	RU 4501-03.....	BS 32	RU 4538-15	RE 17	RU 4555-01.....	RE 22
RU 4473-03.....	RE 6	RU 4501-04.....	BS 32	RU 4538-16	RE 17	RU 4555-02.....	RE 22
RU 4473-04.....	RE 6	RU 4501-06.....	BS 32	RU 4538-17	RE 17	RU 4555-03.....	RE 22
RU 4473-06.....	RE 6	RU 4501-08.....	BS 32	RU 4538-18	RE 17	RU 4555-04.....	RE 22
RU 4474-08.....	RE 7	RU 4502-02.....	BS 32	RU 4538-19	RE 17	RU 4555-05.....	RE 22
RU 4474-10.....	RE 7	RU 4502-03.....	BS 32	RU 4538-20.....	RE 17	RU 4556-25.....	RE 22
RU 4474-12.....	RE 7	RU 4502-04.....	BS 32	RU 4539-11	RE 17	RU 4557-01	RE 23
RU 4474-14.....	RE 7	RU 4502-06.....	BS 32	RU 4539-12	RE 17	RU 4557-02	RE 23
RU 4474-16.....	RE 7	RU 4502-08.....	BS 32	RU 4539-13	RE 17	RU 4557-03	RE 23
RU 4474-18.....	RE 7	RU 4503-01.....	BS 32	RU 4539-14	RE 17	RU 4557-04	RE 23
RU 4474-58.....	RE 8	RU 4506-01.....	BS 33	RU 4539-15	RE 17	RU 4557-05	RE 23
RU 4474-60.....	RE 8	RU 4506-02.....	BS 34	RU 4540-01.....	RE 17	RU 4557-06	RE 23
RU 4474-62.....	RE 8	RU 4506-03.....	BS 34	RU 4540-02.....	RE 17	RU 4557-22	RE 23
RU 4474-64.....	RE 8	RU 4506-04.....	BS 34	RU 4540-03.....	RE 17	RU 4558-01.....	RE 23
RU 4474-66.....	RE 8	RU 4506-06.....	BS 34	RU 4540-04.....	RE 17	RU 4558-02.....	RE 23
RU 4474-68.....	RE 8	RU 4506-08.....	BS 34	RU 4542-01.....	RU 4558-03.....	RE 23
RU 4475-08.....	RE 8	RU 4506-11.....	BS 33	RE 19, GO 19	RU 4560-01.....	RE 23
RU 4475-10.....	RE 8	RU 4506-24.....	BS 33	RU 4542-02.....	RU 4560-02.....	RE 23
RU 4475-11.....	RE 8	RU 4507-01.....	BS 33	RE 19, GO 19	RU 4562-26.....	RE 24
RU 4475-12.....	RE 8	RU 4507-02.....	BS 34	RU 4542-03.....	RU 4563-08.....	RE 24
RU 4475-13.....	RE 8	RU 4507-03.....	BS 34	RE 19, GO 19	RU 4563-10.....	RE 24
RU 4475-14.....	RE 8	RU 4507-04.....	BS 34	RU 4542-04.....	RU 4563-12.....	RE 24
RU 4475-15.....	RE 8	RU 4507-06.....	BS 34	RE 19, GO 19	RU 4563-13.....	RE 24
RU 4475-16.....	RE 8	RU 4507-08.....	BS 34	RU 4542-05.....	RU 4563-14.....	RE 24
RU 4475-18.....	RE 8	RU 4507-11.....	BS 33	RE 19, GO 19	RU 4563-16.....	RE 24
RU 4478-11.....	RE 8	RU 4508-02.....	BS 34	RU 4542-06.....	RU 4563-18.....	RE 24
RU 4479-11.....	RE 8	RU 4508-03.....	BS 34	RE 19, GO 19	RU 4564-01.....	RE 28
RU 4481-01.....	RE 9	RU 4508-04.....	BS 34	RU 4543-00/29.....	RE 18	RU 4564-02.....	RE 28
RU 4481-02.....	RE 9	RU 4508-06.....	BS 34	RU 4543-00/32.....	RE 18	RU 4564-03.....	RE 28
RU 4482-01.....	BS 87	RU 4508-08.....	BS 34	RU 4543-00/33.....	RE 18	RU 4564-04.....	RE 28
RU 4482-02.....	BS 87	RU 4510-03.....	RE 13	RU 4544-01.....	RE 19	RU 4565-01.....	RE 28
RU 4483-01.....	BS 87	RU 4510-04.....	RE 13	RU 4544-02.....	RE 19	RU 4565-02.....	RE 28
RU 4485-20.....	RE 9	RU 4517-01.....	RE 14	RU 4544-03.....	RE 19	RU 4565-03.....	RE 28
RU 4486-01.....	RE 9	RU 4517-02.....	RE 14	RU 4544-40.....	RE 19	RU 4566-26.....	RE 28
RU 4486-02.....	RE 9	RU 4517-03.....	RE 14	RU 4544-47.....	RE 19	RU 4567-01.....	RE 28
RU 4487-01.....	RE 10	RU 4517-04.....	RE 14	RU 4544-48.....	RE 19	RU 4567-02.....	RE 28
RU 4487-02.....	RE 10	RU 4518-00.....	RE 14	RU 4544-49.....	RE 19	RU 4567-51.....	RE 28
RU 4488-14.....	RE 10	RU 4521-08.....	RE 14	RU 4544-50.....	RE 19	RU 4567-52.....	RE 28
RU 4489-01.....	RE 10	RU 4522-01.....	RE 15	RU 4544-65.....	RE 19	RU 4570-01.....	RE 24
RU 4489-02.....	RE 10	RU 4522-02.....	RE 15	RU 4548-30.....	RE 20	RU 4570-02.....	RE 24
RU 4490-01.....	RE 10	RU 4522-05.....	RE 15	RU 4548-33.....	RE 20	RU 4570-03.....	RE 25
RU 4490-02.....	RE 10	RU 4522-21.....	RE 14	RU 4549-22.....	RE 20	RU 4570-04.....	RE 25
RU 4490-03.....	RE 10	RU 4523-01.....	RE 15	RU 4551-01.....	RE 20	RU 4570-05.....	RE 25
RU 4490-13.....	RE 10	RU 4523-02.....	RE 15	RU 4551-02.....	RE 20	RU 4570-06.....	RE 25
RU 4490-16.....	RE 10	RU 4523-03.....	RE 15	RU 4551-03.....	RE 20	RU 4570-07.....	RE 25
RU 4490-25.....	RE 10	RU 4523-04.....	RE 15	RU 4551-51.....	RE 20	RU 4570-08.....	RE 25
RU 4492-00.....	RE 11	RU 4525-19.....	RE 15	RU 4551-52.....	RE 20	RU 4570-09.....	RE 25
RU 4492-01.....	RE 11	RU 4526-01.....	RE 15	RU 4551-53.....	RE 20	RU 4571-04.....	RE 25
RU 4492-02.....	RE 11	RU 4526-02.....	RE 15	RU 4552-11.....	RE 21	RU 4571-07.....	RE 25
RU 4492-03.....	RE 11	RU 4526-03.....	RE 15	RU 4552-12.....	RE 21	RU 4571-08.....	RE 25
RU 4492-13.....	RE 11	RU 4530-01.....	RE 16	RU 4552-13.....	RE 21	RU 4571-09.....	RE 25
RU 4493-19.....	RE 11	RU 4530-02.....	RE 16	RU 4552-14.....	RE 21	RU 4572-01.....	RE 26
RU 4494-21.....	RE 11	RU 4530-03.....	RE 16	RU 4552-15.....	RE 21	RU 4572-02.....	RE 26
RU 4495-13.....	RE 12	RU 4530-04.....	RE 16	RU 4552-22.....	RE 21	RU 4573-01.....	RE 26
RU 4495-18.....	RE 12	RU 4530-05.....	RE 16	RU 4552-53.....	RE 21	RU 4573-02.....	RE 26
RU 4496-00.....	RE 12	RU 4530-06.....	RE 16	RU 4552-54.....	RE 21	RU 4573-03.....	RE 26
RU 4497-12.....	RE 12	RU 4530-07.....	RE 16	RU 4552-55.....	RE 21	RU 4575-00.....	RE 27
RU 4497-15.....	RE 12	RU 4531-01.....	RE 16	RU 4553-00.....	RE 21	RU 4575-01.....	RE 27
RU 4498-00.....	RE 13	RU 4531-05.....	RE 16	RU 4553-01.....	RE 21	RU 4575-02.....	RE 27
RU 4499-00.....	RE 13	RU 4531-06.....	RE 16	RU 4553-02.....	RE 21	RU 4575-51.....	RE 27
RU 4500-01.....	BS 32	RU 4535-01.....	RE 16	RU 4554-00.....	RE 22	RU 4575-52.....	RE 27
RU 4500-02.....	BS 32	RU 4536-01.....	RE 16	RU 4554-01.....	RE 22	RU 4575-53.....	RE 27
RU 4500-03.....	BS 32	RU 4536-02.....	RE 16	RU 4554-02.....	RE 22	RU 4579-01.....	RE 27

Nummernverzeichnis

Numerical Index



RU 4579-02.....	RE27	RU 4702-16.....	RE35	RU 4752-50.....	RE51	RU 4828-02.....	RE61
RU 4580-20.....	RE30	RU 4709-10.....	RE36	RU 4754-00.....	RE51	RU 4829-00.....	RE62
RU 4580-25.....	RE30	RU 4709-20.....	RE36	RU 4754-10.....	RE51	RU 4829-22.....	RE62
RU 4580-30.....	RE30	RU 4710-13.....	RE36	RU 4754-50.....	RE51	RU 4829-23.....	RE62
RU 4580-35.....	RE30	RU 4710-16.....	RE36	RU 4754-60.....	RE51	RU 4830-04.....	RE63
RU 4580-40.....	RE30	RU 4711-13.....	RE36	RU 4754-70.....	RE52	RU 4830-08.....	RE63
RU 4580-45.....	RE30	RU 4711-16.....	RE36	RU 4754-76.....	RE52	RU 4830-10.....	RE63
RU 4580-50.....	RE30	RU 4714-15.....	RE37	RU 4755-17.....	RE38	RU 4832-01.....	RE63
RU 4580-64.....	RE30	RU 4715-14.....	RE37	RU 4756-17.....	RE38	RU 4832-02.....	RE63
RU 4580-76.....	RE30	RU 4716-16.....	RE37	RU 4758-01.....	RE53	RU 4833-01.....	RE63
RU 4580-99.....	RE30	RU 4718-00.....	RE39	RU 4758-02.....	RE53	RU 4833-02.....	RE63
RU 4582-20.....	RE30	RU 4718-01.....	RE39	RU 4758-11.....	RE53	RU 4834-01.....	RE63
RU 4584-06.....	RE30	RU 4718-19.....	RE39	RU 4758-11.....	RE53	RU 4834-02.....	RE63
RU 4584-08.....	RE30	RU 4718-25.....	RE39	RU 4761-00.....	RE48	RU 4834-03.....	RE63
RU 4584-10.....	RE30	RU 4718-32.....	RE39	RU 4761-09.....	RE48	RU 4834-04.....	RE63
RU 4584-12.....	RE30	RU 4719-13.....	RE41	RU 4761-11.....	RE48	RU 4835-01.....	RE64
RU 4584-17.....	RE30	RU 4719-17.....	RE40	RU 4761-13.....	RE48	RU 4835-02.....	RE64
RU 4584-20.....	RE30	RU 4719-20.....	RE40	RU 4761-19.....	RE48	RU 4835-03.....	RE64
RU 4584-25.....	RE30	RU 4719-21.....	RE40	RU 4763-19.....	RE48	RU 4835-09.....	RE64
RU 4584-29.....	RE30	RU 4719-22.....	RE40	RU 4764-01.....	RE48	RU 4835-10.....	RE64
RU 4585-01.....	RE30	RU 4719-23.....	RE40	RU 4764-02.....	RE48	RU 4835-12.....	RE64
RU 4585-02.....	RE30	RU 4719-27.....	RE40	RU 4764-04.....	RE48	RU 4835-13.....	RE64
RU 4585-03.....	RE30	RU 4719-30.....	RE40	RU 4765-01.....	RE49	RU 4835-15.....	RE64
RU 4587-28.....	RE30	RU 4720-13.....	RE41	RU 4765-02.....	RE49	RU 4850-03.....	SK2
RU 4590-01.....	RE29	RU 4721-13.....	RE41	RU 4767-19.....	RE49	RU 4850-04.....	SK4
RU 4590-02.....	RE29	RU 4722-13.....	RE41	RU 4768-12.....	RE49	RU 4850-07.....	SK2
RU 4591-01.....	RE29	RU 4722-16.....	RE41	RU 4768-17.....	RE49	RU 4850-13.....	SK2
RU 4591-02.....	RE29	RU 4723-13.....	RE41	RU 4769-00.....	RE54	RU 4850-14.....	SK4
RU 4591-03.....	RE29	RU 4723-16.....	RE41	RU 4770-02.....	RE54	RU 4850-17.....	SK2
RU 4593-01.....	RE29	RU 4724-20.....	RE42	RU 4771-00.....	RE55	RU 4850-31.....	SK3
RU 4593-02.....	RE29	RU 4724-25.....	RE42	RU 4771-11.....	RE55	RU 4850-32.....	SK3
RU 4593-03.....	RE29	RU 4725-20.....	RE42	RU 4774-00.....	RE55	RU 4850-41.....	SK4
RU 4593-04.....	RE29	RU 4725-25.....	RE42	RU 4798-00.....	RE56	RU 4850-42.....	SK4
RU 4593-05.....	RE29	RU 4726-25.....	RE42	RU 4798-11.....	RE56	RU 4850-50.....	SK3
RU 4593-06.....	RE29	RU 4727-25.....	RE42	RU 4800-00.....	RE56	RU 4850-51.....	SK3
RU 4640-05.....	RE31	RU 4728-20.....	RE43	RU 4800-11.....	RE56	RU 4851-10.....	SK2, SK3
RU 4640-07.....	RE31	RU 4729-20.....	RE43	RU 4802-00.....	RE57	RU 4851-11.....	SK2, SK3
RU 4641-05.....	RE31	RU 4730-20.....	RE43	RU 4802-11.....	RE57	RU 4851-12.....	SK2, SK3
RU 4641-07.....	RE31	RU 4731-20.....	RE43	RU 4804-00.....	RE57	RU 4851-13.....	SK2, SK3
RU 4642-07.....	RE31	RU 4732-24.....	RE44	RU 4804-11.....	RE57	RU 4851-15.....	SK2, SK3
RU 4643-08.....	RE31	RU 4734-20.....	RE44	RU 4806-00.....	RE58	RU 4851-18.....	SK4
RU 4643-11.....	RE31	RU 4734-26.....	RE44	RU 4806-11.....	RE58	RU 4851-19.....	SK4
RU 4650-07.....	RE31	RU 4735-20.....	RE44	RU 4807-00.....	RE58	RU 4851-20.....	SK4
RU 4651-07.....	RE31	RU 4735-26.....	RE44	RU 4807-11.....	RE58	RU 4851-21.....	SK4
RU 4651-10.....	RE31	RU 4738-21.....	RE45	RU 4810-00.....	RE59	RU 4851-22.....	SK4
RU 4655-00.....	RE31	RU 4739-01.....	RE45	RU 4810-01.....	RE59	RU 4851-23.....	SK4
RU 4655-10.....	RE31	RU 4739-02.....	RE45	RU 4810-02.....	RE59	RU 4852-10.....	SK2
RU 4660-01.....	RE32	RU 4739-11.....	RE45	RU 4810-03.....	RE59	RU 4852-10.....	SK3
RU 4660-02.....	RE32	RU 4739-12.....	RE45	RU 4810-04.....	RE59	RU 4852-11.....	SK2
RU 4660-03.....	RE32	RU 4739-21.....	RE45	RU 4810-05.....	RE59	RU 4852-11.....	SK3
RU 4660-04.....	RE32	RU 4739-22.....	RE45	RU 4810-10.....	RE59	RU 4852-12.....	SK2
RU 4680-10.....	RE32	RU 4740-27.....	RE46	RU 4820-00.....	RE60	RU 4852-12.....	SK3
RU 4681-10.....	RE32	RU 4740-51.....	RE46	RU 4820-10.....	RE60	RU 4852-13.....	SK2
RU 4688-01.....	RE33	RU 4741-27.....	RE46	RU 4821-00.....	RE60	RU 4852-13.....	SK3
RU 4688-02.....	RE33	RU 4741-51.....	RE46	RU 4821-10.....	RE60	RU 4852-15.....	SK2
RU 4690-01.....	RE34	RU 4742-31.....	RE46	RU 4822-01.....	RE60	RU 4852-15.....	SK3
RU 4690-02.....	RE34	RU 4743-31.....	RE46	RU 4822-02.....	RE60	RU 4852-18.....	SK4
RU 4691-01.....	RE34	RU 4743-33.....	RE47	RU 4822-03.....	RE60	RU 4852-19.....	SK4
RU 4691-02.....	RE34	RU 4743-41.....	RE46	RU 4822-04.....	RE60	RU 4852-20.....	SK4
RU 4694-11.....	RE35	RU 4745-27.....	RE47	RU 4822-05.....	RE60	RU 4852-21.....	SK4
RU 4700-10.....	RE35	RU 4749-33.....	RE47	RU 4822-06.....	RE60	RU 4852-22.....	SK4
RU 4700-13.....	RE35	RU 4750-00.....	RE50	RU 4826-00.....	RE61	RU 4852-23.....	SK4
RU 4700-16.....	RE35	RU 4750-50.....	RE50	RU 4826-10.....	RE61	RU 4853-33.....	SK1
RU 4701-10.....	RE35	RU 4750-51.....	RE50	RU 4827-00.....	RE61	RU 4853-34.....	SK1
RU 4701-13.....	RE35	RU 4751-00.....	RE50	RU 4827-10.....	RE61	RU 4853-35.....	SK1
RU 4701-16.....	RE35	RU 4751-51.....	RE50	RU 4828-01.....	RE61	RU 4853-64.....	SK1
RU 4702-10.....	RE35	RU 4751-52.....	RE50	RU 4828-01.....	RE61	RU 4853-65.....	SK1
RU 4702-13.....	RE35	RU 4752-00.....	RE51	RU 4828-02.....	RE61	RU 4853-67.....	SK1

Nummernverzeichnis

Numerical Index



RU 4853-69.....	SK 1	RU 4910-14.....	TS 15	RU 5286-60.....	TS 11	RU 5311-02	BS 2
RU 4854-03.....	SK 1	RU 4910-16	TS 15	RU 5286-65.....	TS 11	RU 5311-03	BS 2
RU 4854-04.....	SK 1	RU 4910-18	TS 15	RU 5286-70.....	TS 11	RU 5311-11	BS 2
RU 4858-01.....	SK 7	RU 4910-20	TS 15	RU 5286-75	TS 11	RU 5311-12	BS 2
RU 4858-02.....	SK 7	RU 4911-14.....	TS 15	RU 5286-77	TS 11	RU 5311-13	BS 2
RU 4858-03.....	SK 7	RU 4912-13.....	TS 15	RU 5286-80.....	TS 11	RU 5311-21.....	BS 2
RU 4858-04.....	SK 7	RU 4912-14.....	TS 15	RU 5286-85.....	TS 11	RU 5311-22.....	BS 2
RU 4858-05.....	SK 7	RU 4912-16.....	TS 15	RU 5286-90.....	TS 11	RU 5311-23.....	BS 2
RU 4858-06.....	SK 7	RU 4912-18.....	TS 15	RU 5288-01.....	TS 12	RU 5317-03	BS 2
RU 4858-07.....	SK 7	RU 4913-14.....	TS 15	RU 5288-02.....	TS 12	RU 5317-05	BS 2
RU 4858-08.....	SK 7	RU 4914-13.....	TS 15	RU 5288-03.....	TS 12	RU 5317-07	BS 2
RU 4858-09.....	SK 7	RU 4914-14.....	TS 15	RU 5288-04.....	TS 12	RU 5317-09	BS 2
RU 4858-10	SK 7	RU 4914-16.....	TS 15	RU 5288-21	TS 12	RU 5320-04.....	BS 2
RU 4874-00.....	SK 5	RU 4914-20	TS 15	RU 5288-31	TS 12	RU 5320-06.....	BS 2
RU 4876-09.....	SK 5	RU 4915-16	TS 16	RU 5291-08.....	TS 13	RU 5320-08.....	BS 2
RU 4877-09	SK 5	RU 4916-10	TS 16	RU 5291-10.....	TS 13	RU 5320-10	BS 2
RU 4878-13.....	SK 5	RU 4917-18.....	TS 16	RU 5291-12.....	TS 13	RU 5320-12	BS 2
RU 4878-23.....	SK 6	RU 4921-23	TS 18	RU 5291-14.....	TS 13	RU 5320-14	BS 2
RU 4878-33.....	SK 5	RU 4922-28	TS 18	RU 5291-16.....	TS 13	RU 5321-01	BS 2
RU 4878-53.....	SK 6	RU 4923-16	TS 16	RU 5291-18.....	TS 13	RU 5321-02	BS 2
RU 4879-18	SK 6	RU 4925-01	TS 17	RU 5291-28	TS 13	RU 5321-03	BS 2
RU 4880-13	SK 8	RU 4925-02	TS 17	RU 5291-30	TS 13	RU 5321-04	BS 2
RU 4880-16	SK 8	RU 4925-03	TS 17	RU 5291-32	TS 13	RU 5321-05	BS 2
RU 4880-19	SK 8	RU 4925-04.....	TS 17	RU 5291-34	TS 13	RU 5321-06.....	BS 2
RU 4880-22.....	SK 8	RU 4926-01	TS 17	RU 5291-36.....	TS 13	RU 5321-07	BS 2
RU 4881-17.....	SK 8	RU 4926-02	TS 17	RU 5291-38.....	TS 13	RU 5321-11.....	BS 2
RU 4881-20	SK 8	RU 4926-03.....	TS 17	RU 5291-48.....	TS 13	RU 5321-12.....	BS 2
RU 4888-05.....	SK 9	RU 4927-12.....	TS 18	RU 5291-50.....	TS 13	RU 5321-13.....	BS 2
RU 4892-11.....	SK 9	RU 4928-01.....	TS 18	RU 5291-52.....	TS 13	RU 5321-14.....	BS 2
RU 4894-09.....	SK 9	RU 4928-02.....	TS 19	RU 5291-54	TS 13	RU 5321-15.....	BS 2
RU 4899-00.....	SK 10	RU 4930-12	TS 19	RU 5291-56.....	TS 13	RU 5321-16.....	BS 2
RU 4899-01.....	SK 10	RU 4930-16	TS 19	RU 5291-58.....	TS 13	RU 5321-17.....	BS 2
RU 4899-02.....	SK 10	RU 4931-18.....	TS 19	RU 5295-15	TS 10	RU 5322-04.....	BS 2
RU 4899-03.....	SK 10	RU 4933-02.....	TS 19	RU 5295-20.....	TS 10	RU 5322-06.....	BS 2
RU 4899-10	SK 10	RU 4934-01.....	TS 20	RU 5295-25.....	TS 10	RU 5322-08.....	BS 2
RU 4900-11	TS 14	RU 4934-02.....	TS 20	RU 5300-04.....	BS 1	RU 5322-10	BS 2
RU 4900-13.....	TS 14	RU 4934-03.....	TS 20	RU 5300-06	BS 1	RU 5322-12	BS 2
RU 4900-14	TS 14	RU 4935-14	TS 20	RU 5300-08.....	BS 1	RU 5322-14	BS 2
RU 4900-16	TS 14	RU 4935-16	TS 20	RU 5300-10.....	BS 1	RU 5323-06.....	BS 3
RU 4900-18	TS 14	RU 4936-14	TS 20	RU 5300-12	BS 1	RU 5323-09.....	BS 3
RU 4900-20.....	TS 14	RU 4936-16.....	TS 20	RU 5300-14	BS 1	RU 5323-13.....	BS 3
RU 4900-25.....	TS 14	RU 4941-28	TS 20	RU 5300-16	BS 1	RU 5323-16	BS 3
RU 4901-11.....	TS 14	RU 4941-45.....	TS 20	RU 5301-00.....	BS 1	RU 5323-19	BS 3
RU 4901-13	TS 14	RU 5212-04	TS 1	RU 5301-05.....	BS 1	RU 5323-25	BS 3
RU 4901-14.....	TS 14	RU 5220-16	TS 2	RU 5301-06.....	BS 1	RU 5323-32.....	BS 3
RU 4901-16	TS 14	RU 5232-16	TS 2	RU 5301-10	BS 1	RU 5325-06.....	BS 3
RU 4901-18	TS 14	RU 5250-40.....	TS 2	RU 5301-16	BS 1	RU 5325-09.....	BS 3
RU 4901-20.....	TS 14	RU 5250-46.....	TS 2	RU 5301-25	BS 1	RU 5325-13	BS 3
RU 4901-25.....	TS 14	RU 5250-55.....	TS 2	RU 5301-50.....	BS 1	RU 5325-16	BS 3
RU 4902-11	TS 14	RU 5250-65.....	TS 2	RU 5302-04.....	BS 1	RU 5325-19	BS 3
RU 4902-13	TS 14	RU 5260-27.....	TS 3	RU 5302-06.....	BS 1	RU 5325-25	BS 3
RU 4902-14	TS 14	RU 5265-00.....	TS 3	RU 5302-08.....	BS 1	RU 5325-32.....	BS 3
RU 4902-16	TS 14	RU 5280-22.....	TS 3	RU 5302-10	BS 1	RU 5325-06.....	BS 3
RU 4902-18	TS 14	RU 5281-22	TS 3	RU 5302-12	BS 1	RU 5327-09.....	BS 3
RU 4902-20.....	TS 14	RU 5282-48.....	TS 4	RU 5302-14	BS 1	RU 5327-13	BS 3
RU 4902-25.....	TS 14	RU 5285-02.....	TS 11	RU 5302-16	BS 1	RU 5327-16.....	BS 3
RU 4906-11	TS 14	RU 5285-05.....	TS 11	RU 5304-04.....	BS 1	RU 5327-19.....	BS 3
RU 4906-13.....	TS 14	RU 5285-10.....	TS 11	RU 5304-06.....	BS 1	RU 5327-25.....	BS 3
RU 4906-14.....	TS 14	RU 5285-52.....	TS 11	RU 5304-08.....	BS 1	RU 5327-32.....	BS 3
RU 4906-16.....	TS 14	RU 5285-55.....	TS 11	RU 5304-10	BS 1	RU 5329-06.....	BS 3
RU 4906-18	TS 14	RU 5285-60.....	TS 11	RU 5304-12	BS 1	RU 5329-09.....	BS 3
RU 4906-20.....	TS 14	RU 5286-05.....	TS 11	RU 5304-14	BS 1	RU 5329-13	BS 3
RU 4907-13.....	TS 14	RU 5286-07.....	TS 11	RU 5304-16	BS 1	RU 5329-16	BS 3
RU 4907-18.....	TS 14	RU 5286-10	TS 11	RU 5305-34.....	BS 1	RU 5329-19	BS 3
RU 4908-14.....	TS 14	RU 5286-15	TS 11	RU 5305-36.....	BS 1	RU 5329-25.....	BS 3
RU 4908-18	TS 14	RU 5286-20	TS 11	RU 5305-44.....	BS 1	RU 5329-32.....	BS 3
RU 4910-11.....	TS 15	RU 5286-55.....	TS 11	RU 5305-46.....	BS 1	RU 5330-04.....	BS 4
RU 4910-13	TS 15	RU 5286-57.....	TS 11	RU 5311-01	BS 2	RU 5330-06.....	BS 4

Nummernverzeichnis

Numerical Index



RU 5330-08.....	BS 4	RU 5340-10.....	BS 6	RU 5345-56.....	BS 6	RU 5351-78.....	BS 9
RU 5330-10.....	BS 4	RU 5340-12.....	BS 6	RU 5345-59.....	BS 6	RU 5351-79.....	BS 9
RU 5330-13.....	BS 4	RU 5340-15.....	BS 6	RU 5345-63.....	BS 6	RU 5351-80.....	BS 9
RU 5330-16.....	BS 4	RU 5340-20.....	BS 6	RU 5345-66.....	BS 6	RU 5351-81.....	BS 9
RU 5330-18.....	BS 4	RU 5340-25.....	BS 6	RU 5345-69.....	BS 6	RU 5351-82.....	BS 9
RU 5330-20.....	BS 4	RU 5340-30.....	BS 6	RU 5345-72.....	BS 6	RU 5351-83.....	BS 9
RU 5330-25.....	BS 4	RU 5341-06.....	BS 6	RU 5345-75.....	BS 6	RU 5351-84.....	BS 9
RU 5330-30.....	BS 4	RU 5341-08.....	BS 6	RU 5345-78.....	BS 6	RU 5351-85.....	BS 9
RU 5330-38.....	BS 4	RU 5341-10.....	BS 6	RU 5345-82.....	BS 6	RU 5351-86.....	BS 9
RU 5330-44.....	BS 4	RU 5341-12.....	BS 6	RU 5345-88.....	BS 6	RU 5352-01.....	BS 10
RU 5330-50.....	BS 4	RU 5341-15.....	BS 6	RU 5346-06.....	BS 6	RU 5352-02.....	BS 10
RU 5331-04.....	BS 4	RU 5341-20.....	BS 6	RU 5346-09.....	BS 6	RU 5352-03.....	BS 10
RU 5331-06.....	BS 4	RU 5341-25.....	BS 6	RU 5346-13.....	BS 6	RU 5352-04.....	BS 10
RU 5331-08.....	BS 4	RU 5341-30.....	BS 6	RU 5346-16.....	BS 6	RU 5352-05.....	BS 10
RU 5331-10.....	BS 4	RU 5341-56.....	BS 6	RU 5346-19.....	BS 6	RU 5352-06.....	BS 10
RU 5331-13.....	BS 4	RU 5341-58.....	BS 6	RU 5346-22.....	BS 6	RU 5352-10.....	BS 10
RU 5331-16.....	BS 4	RU 5341-60.....	BS 6	RU 5346-25.....	BS 6	RU 5352-20.....	BS 10
RU 5331-18.....	BS 4	RU 5341-62.....	BS 6	RU 5346-28.....	BS 6	RU 5352-30.....	BS 10
RU 5331-20.....	BS 4	RU 5341-65.....	BS 6	RU 5346-32.....	BS 6	RU 5353-01.....	BS 10
RU 5331-25.....	BS 4	RU 5341-70.....	BS 6	RU 5346-38.....	BS 6	RU 5353-02.....	BS 10
RU 5331-30.....	BS 4	RU 5341-75.....	BS 6	RU 5346-56.....	BS 6	RU 5353-03.....	BS 10
RU 5331-38.....	BS 4	RU 5341-80.....	BS 6	RU 5346-59.....	BS 6	RU 5353-04.....	BS 10
RU 5331-44.....	BS 4	RU 5342-06.....	BS 6	RU 5346-63.....	BS 6	RU 5353-05.....	BS 10
RU 5331-50.....	BS 4	RU 5342-08.....	BS 6	RU 5346-66.....	BS 6	RU 5353-06.....	BS 10
RU 5332-02.....	BS 4	RU 5342-10.....	BS 6	RU 5346-69.....	BS 6	RU 5353-10.....	BS 10
RU 5332-03.....	BS 4	RU 5342-12.....	BS 6	RU 5346-72.....	BS 6	RU 5353-20.....	BS 10
RU 5332-04.....	BS 4	RU 5342-15.....	BS 6	RU 5346-75.....	BS 6	RU 5353-30.....	BS 10
RU 5332-06.....	BS 4	RU 5342-20.....	BS 6	RU 5346-78.....	BS 6	RU 5353-40.....	BS 10
RU 5332-08.....	BS 4	RU 5342-25.....	BS 6	RU 5346-82.....	BS 6	RU 5354-22.....	BS 11
RU 5332-10.....	BS 4	RU 5342-30.....	BS 6	RU 5346-88.....	BS 6	RU 5354-23.....	BS 11
RU 5332-12.....	BS 4	RU 5342-56.....	BS 6	RU 5348-05X.....	BS 7	RU 5354-24.....	BS 11
RU 5332-15.....	BS 4	RU 5342-58.....	BS 6	RU 5348-10X.....	BS 7	RU 5354-25.....	BS 11
RU 5333-02.....	BS 4	RU 5342-60.....	BS 6	RU 5348-15X.....	BS 7	RU 5354-26.....	BS 11
RU 5333-03.....	BS 4	RU 5342-62.....	BS 6	RU 5348-55X.....	BS 7	RU 5354-27.....	BS 11
RU 5333-04.....	BS 4	RU 5342-65.....	BS 6	RU 5348-60X.....	BS 7	RU 5354-28.....	BS 11
RU 5333-06.....	BS 4	RU 5342-70.....	BS 6	RU 5348-65X.....	BS 7	RU 5354-30.....	BS 11
RU 5333-08.....	BS 4	RU 5342-75.....	BS 6	RU 5349-01.....	BS 8	RU 5354-32.....	BS 11
RU 5333-10.....	BS 4	RU 5342-80.....	BS 6	RU 5349-02.....	BS 8	RU 5354-34.....	BS 11
RU 5333-12.....	BS 4	RU 5344-06.....	BS 6	RU 5349-03.....	BS 8	RU 5354-42.....	BS 11
RU 5333-15.....	BS 4	RU 5344-09.....	BS 6	RU 5349-04.....	BS 8	RU 5354-43.....	BS 11
RU 5334-04X.....	BS 5	RU 5344-13.....	BS 6	RU 5350-01.....	BS 9	RU 5354-44.....	BS 11
RU 5334-06X.....	BS 5	RU 5344-16.....	BS 6	RU 5350-02.....	BS 9	RU 5354-45.....	BS 11
RU 5334-08X.....	BS 5	RU 5344-19.....	BS 6	RU 5350-03.....	BS 9	RU 5354-46.....	BS 11
RU 5334-10X.....	BS 5	RU 5344-22.....	BS 6	RU 5350-04.....	BS 9	RU 5354-47.....	BS 11
RU 5334-12X.....	BS 5	RU 5344-25.....	BS 6	RU 5350-05.....	BS 9	RU 5354-48.....	BS 11
RU 5335-04X.....	BS 5	RU 5344-28.....	BS 6	RU 5350-06.....	BS 9	RU 5354-50.....	BS 11
RU 5335-06X.....	BS 5	RU 5344-32.....	BS 6	RU 5350-10.....	BS 9	RU 5354-52.....	BS 11
RU 5335-08X.....	BS 5	RU 5344-38.....	BS 6	RU 5350-20.....	BS 9	RU 5354-54.....	BS 11
RU 5335-10X.....	BS 5	RU 5344-56.....	BS 6	RU 5350-30.....	BS 9	RU 5355-01.....	BS 11
RU 5335-12X.....	BS 5	RU 5344-59.....	BS 6	RU 5350-40.....	BS 9	RU 5355-02.....	BS 11
RU 5336-05X.....	BS 5	RU 5344-63.....	BS 6	RU 5351-08.....	BS 9	RU 5355-03.....	BS 11
RU 5336-07X.....	BS 5	RU 5344-66.....	BS 6	RU 5351-09.....	BS 9	RU 5355-04.....	BS 11
RU 5336-10X.....	BS 5	RU 5344-69.....	BS 6	RU 5351-10.....	BS 9	RU 5355-10.....	BS 11
RU 5336-15X.....	BS 5	RU 5344-72.....	BS 6	RU 5351-11.....	BS 9	RU 5355-20.....	BS 11
RU 5336-20X.....	BS 5	RU 5344-75.....	BS 6	RU 5351-12.....	BS 9	RU 5355-30.....	BS 11
RU 5336-25X.....	BS 5	RU 5344-78.....	BS 6	RU 5351-13.....	BS 9	RU 5356-01.....	BS 12
RU 5336-30X.....	BS 5	RU 5344-82.....	BS 6	RU 5351-14.....	BS 9	RU 5356-02.....	BS 12
RU 5336-40X.....	BS 5	RU 5344-88.....	BS 6	RU 5351-15.....	BS 9	RU 5356-10.....	BS 12
RU 5338-05X.....	BS 5	RU 5345-06.....	BS 6	RU 5351-16.....	BS 9	RU 5356-20.....	BS 12
RU 5338-07X.....	BS 5	RU 5345-09.....	BS 6	RU 5351-58.....	BS 9	RU 5357-01.....	BS 12
RU 5338-10X.....	BS 5	RU 5345-13.....	BS 6	RU 5351-59.....	BS 9	RU 5357-02.....	BS 12
RU 5338-15X.....	BS 5	RU 5345-16.....	BS 6	RU 5351-60.....	BS 9	RU 5358-01.....	BS 12
RU 5338-20X.....	BS 5	RU 5345-19.....	BS 6	RU 5351-61.....	BS 9	RU 5358-02.....	BS 12
RU 5338-25X.....	BS 5	RU 5345-22.....	BS 6	RU 5351-62.....	BS 9	RU 5358-03.....	BS 12
RU 5338-30X.....	BS 5	RU 5345-25.....	BS 6	RU 5351-63.....	BS 9	RU 5358-10.....	BS 12
RU 5338-40X.....	BS 5	RU 5345-28.....	BS 6	RU 5351-64.....	BS 9	RU 5361-01.....	BS 12
RU 5340-06.....	BS 6	RU 5345-32.....	BS 6	RU 5351-65.....	BS 9	RU 5361-02.....	BS 12
RU 5340-08.....	BS 6	RU 5345-38.....	BS 6	RU 5351-66.....	BS 9	RU 5361-10.....	BS 12

Nummernverzeichnis

Numerical Index



RU 5361-20.....	BS 12	RU 5398-04.....	BS 21	RU 5442-17.....	BS 29	RU 5540-17.....	BS 43
RU 5362-01.....	BS 14	RU 5398-05.....	BS 21	RU 5442-18.....	BS 29	RU 5542-18.....	BS 44
RU 5362-02.....	BS 14	RU 5398-06.....	BS 21	RU 5442-24.....	BS 29	RU 5542-20.....	BS 44
RU 5362-03.....	BS 14	RU 5398-07.....	BS 21	RU 5442-34.....	BS 29	RU 5542-22.....	BS 44
RU 5363-01.....	BS 14	RU 5400-01.....	BS 21	RU 5442-42.....	BS 29	RU 5543-12.....	BS 44
RU 5363-02.....	BS 14	RU 5400-02.....	BS 21	RU 5442-50.....	BS 30	RU 5558-01.....	BS 45
RU 5363-03.....	BS 14	RU 5402-01.....	BS 21	RU 5442-65.....	BS 30	RU 5558-02.....	BS 45
RU 5363-04.....	BS 14	RU 5402-02.....	BS 21	RU 5444-01.....	BS 30	RU 5559-17.....	BS 45
RU 5363-101.....	BS 13	RU 5407-01.....	BS 21	RU 5444-06.....	BS 30	RU 5560-12.....	BS 45
RU 5363-103.....	BS 13	RU 5409-01.....	BS 22	RU 5444-10.....	BS 30	RU 5560-14.....	BS 45
RU 5363-11.....	BS 14	RU 5409-02.....	BS 22	RU 5444-12.....	BS 31	RU 5561-15.....	BS 46
RU 5363-111.....	BS 13	RU 5409-03.....	BS 22	RU 5445-32.....	BS 31	RU 5561-90.....	BS 46
RU 5363-113.....	BS 13	RU 5409-24.....	BS 22	RU 5447-01.....	BS 31	RU 5562-14.....	BS 46
RU 5363-12.....	BS 14	RU 5409-25.....	BS 22	RU 5447-02.....	BS 31	RU 5562-17.....	BS 46
RU 5363-13.....	BS 14	RU 5409-27.....	BS 22	RU 5450-44.....	BS 31	RU 5563-18.....	BS 46
RU 5363-14.....	BS 14	RU 5409-29.....	BS 22	RU 5450-64.....	BS 31	RU 5565-20.....	BS 46
RU 5363-301.....	BS 13	RU 5410-01X.....	BS 23	RU 5480-17.....	BS 35	RU 5566-16.....	BS 47
RU 5363-303.....	BS 13	RU 5410-02X.....	BS 23	RU 5481-17.....	BS 35	RU 5568-16.....	BS 47
RU 5364-13.....	BS 14	RU 5410-03X.....	BS 23	RU 5482-17.....	BS 35	RU 5570-16.....	BS 47
RU 5364-14.....	BS 14	RU 5410-04X.....	BS 23	RU 5500-20.....	BS 36	RU 5570-19.....	BS 47
RU 5364-17.....	BS 14	RU 5410-05.....	BS 22	RU 5501-20.....	BS 36	RU 5571-16.....	BS 47
RU 5364-20.....	BS 14	RU 5410-06.....	BS 24	RU 5505-19.....	BS 36	RU 5571-19.....	BS 47
RU 5365-13.....	BS 14	RU 5410-07.....	BS 24	RU 5506-19.....	BS 36	RU 5572-18.....	BS 47
RU 5365-16.....	BS 14	RU 5410-15.....	BS 22	RU 5508-19.....	BS 36	RU 5573-17.....	BS 47
RU 5365-20.....	BS 14	RU 5410-20.....	BS 24	RU 5510-00.....	BS 37	RU 5574-17.....	BS 47
RU 5366-00.....	BS 15	RU 5412-10X.....	BS 23	RU 5510-20.....	BS 37	RU 5575-01.....	BS 48
RU 5366-01.....	BS 15	RU 5412-11X.....	BS 23	RU 5511-20.....	BS 37	RU 5575-02.....	BS 48
RU 5366-12.....	BS 15	RU 5412-14X.....	BS 23	RU 5512-17.....	BS 37	RU 5576-15.....	BS 48
RU 5368-00.....	BS 15	RU 5412-17X.....	BS 23	RU 5514-21.....	BS 37	RU 5576-19.....	BS 48
RU 5368-01.....	BS 15	RU 5412-50.....	BS 24	RU 5516-21.....	BS 38	RU 5579-01.....	BS 48
RU 5368-12.....	BS 15	RU 5412-51.....	BS 24	RU 5518-16.....	BS 38	RU 5580-17.....	BS 49
RU 5369-13.....	BS 15	RU 5412-54.....	BS 24	RU 5518-24.....	BS 38	RU 5580-67.....	BS 49
RU 5370-21.....	BS 15	RU 5412-57.....	BS 24	RU 5520-17.....	BS 38	RU 5581-17.....	BS 49
RU 5374-02.....	BS 16	RU 5412-60.....	BS 24	RU 5520-21.....	BS 38	RU 5581-67.....	BS 49
RU 5375-30.....	BS 16	RU 5417-01.....	BS 24	RU 5521-17.....	BS 38	RU 5582-15.....	BS 49
RU 5376-27.....	BS 16	RU 5417-02.....	BS 24	RU 5521-21.....	BS 38	RU 5583-15.....	BS 49
RU 5377-25.....	BS 16	RU 5418-01.....	BS 25	RU 5522-18.....	BS 39	RU 5584-15.....	BS 49
RU 5378-24.....	BS 16	RU 5418-03.....	BS 25	RU 5522-23.....	BS 39	RU 5585-01.....	BS 50
RU 5379-19.....	BS 17	RU 5418-05.....	BS 25	RU 5522-25.....	BS 39	RU 5585-02.....	BS 50
RU 5379-22.....	BS 16	RU 5419-18.....	BS 25	RU 5522-28.....	BS 39	RU 5585-21.....	BS 50
RU 5380-15.....	BS 17	RU 5420-20.....	BS 25	RU 5524-21.....	BS 39	RU 5587-02.....	BS 50
RU 5381-15.....	BS 17	RU 5421-20.....	BS 25	RU 5524-27.....	BS 39	RU 5587-12.....	BS 50
RU 5382-18.....	BS 17	RU 5422-23.....	BS 25	RU 5524-30.....	BS 39	RU 5588-03.....	BS 50
RU 5382-21.....	BS 17	RU 5423-15.....	BS 26	RU 5525-19.....	BS 39	RU 5588-15.....	BS 50
RU 5384-18.....	BS 18	RU 5425-17.....	BS 26	RU 5525-51.....	BS 39	RU 5589-13.....	BS 50
RU 5384-30.....	BS 18	RU 5426-16.....	BS 26	RU 5527-17.....	BS 40	RU 5589-15.....	BS 50
RU 5384-31.....	BS 18	RU 5427-20.....	BS 26	RU 5527-25.....	BS 40	RU 5589-18.....	BS 50
RU 5385-05.....	BS 18	RU 5430-03.....	BS 26	RU 5527-26.....	BS 40	RU 5590-18.....	BS 51
RU 5385-10.....	BS 18	RU 5430-06.....	BS 26	RU 5527-27.....	BS 40	RU 5592-18.....	BS 51
RU 5385-15.....	BS 18	RU 5430-10.....	BS 26	RU 5528-15.....	BS 41	RU 5593-17.....	BS 51
RU 5385-20.....	BS 18	RU 5430-12.....	BS 26	RU 5528-19.....	BS 41	RU 5594-02.....	BS 51
RU 5385-25.....	BS 18	RU 5430-16.....	BS 26	RU 5528-24.....	BS 41	RU 5594-18.....	BS 52
RU 5386-19.....	BS 18	RU 5430-19.....	BS 26	RU 5528-26.....	BS 41	RU 5594-23.....	BS 52
RU 5387-20.....	BS 19	RU 5430-25.....	BS 26	RU 5528-28.....	BS 41	RU 5594-24.....	BS 52
RU 5388-16.....	BS 19	RU 5431-01.....	BS 27	RU 5529-30.....	BS 41	RU 5594-34.....	BS 52
RU 5389-19.....	BS 19	RU 5431-02.....	BS 27	RU 5533-26.....	BS 41	RU 5594-51.....	BS 52
RU 5390-13.....	BS 19	RU 5432-21.....	BS 27	RU 5534-33.....	BS 42	RU 5594-53.....	BS 52
RU 5391-15.....	BS 19	RU 5434-19.....	BS 27	RU 5534-45.....	BS 42	RU 5595-20.....	BS 52
RU 5392-16.....	BS 19	RU 5435-17.....	BS 27	RU 5535-19.....	BS 41	RU 5596-24.....	BS 52
RU 5393-01.....	BS 20	RU 5437-14.....	BS 28	RU 5535-23.....	BS 41	RU 5597-03.....	BS 53
RU 5393-02.....	BS 20	RU 5438-15.....	BS 28	RU 5535-26.....	BS 41	RU 5597-13.....	BS 53
RU 5393-03.....	BS 20	RU 5438-55.....	BS 28	RU 5536-33.....	BS 42	RU 5597-14.....	BS 53
RU 5393-04.....	BS 20	RU 5439-01.....	BS 28	RU 5536-45.....	BS 42	RU 5597-15.....	BS 53
RU 5394-06.....	BS 20	RU 5439-02/12.....	BS 28	RU 5537-14.....	BS 42	RU 5597-23.....	BS 53
RU 5394-08.....	BS 20	RU 5440-06.....	BS 28	RU 5538-12.....	BS 42	RU 5597-24.....	BS 53
RU 5398-01.....	BS 21	RU 5440-08.....	BS 28	RU 5538-12.....	BS 42	RU 5597-25.....	BS 53
RU 5398-02.....	BS 21	RU 5440-24.....	BS 28	RU 5539-13.....	BS 43	RU 5600-22.....	BS 54
RU 5398-03.....	BS 21	RU 5442-10.....	BS 29	RU 5539-20.....	BS 43	RU 5600-27.....	BS 54
				RU 5540-01.....	BS 43	RU 5601-22.....	BS 54



RU 5601-27	BS54	RU 5746-03	BS64	RU 5751-49	BS67	RU 5755-50	BS67
RU 5602-23	BS55	RU 5746-04	BS64	RU 5751-50	BS67	RU 5755-52	BS67
RU 5604-23	BS55	RU 5746-05	BS64	RU 5751-52	BS67	RU 5755-55	BS67
RU 5606-03	BS55	RU 5746-06	BS64	RU 5751-55	BS67	RU 5755-58	BS67
RU 5606-04	BS55	RU 5746-07	BS64	RU 5751-58	BS67	RU 5755-60	BS67
RU 5606-05	BS55	RU 5746-08	BS64	RU 5751-60	BS67	RU 5755-72	BS68
RU 5606-06	BS55	RU 5746-09	BS64	RU 5754-08	BS67	RU 5755-74	BS68
RU 5606-07	BS55	RU 5746-10	BS64	RU 5754-10	BS67	RU 5755-76	BS68
RU 5606-08	BS55	RU 5746-50	BS65	RU 5754-11	BS67	RU 5755-78	BS68
RU 5606-13	BS56	RU 5747-01	BS65	RU 5754-12	BS67	RU 5755-80	BS68
RU 5606-14	BS56	RU 5747-11	BS65	RU 5754-14	BS67	RU 5755-82	BS68
RU 5606-15	BS56	RU 5749-06	BS66	RU 5754-15	BS67	RU 5755-85	BS68
RU 5606-16	BS56	RU 5749-11	BS66	RU 5754-16	BS67	RU 5756-08	BS68
RU 5606-17	BS56	RU 5749-19	BS66	RU 5754-17	BS67	RU 5756-10	BS68
RU 5606-18	BS56	RU 5750-08	BS67	RU 5754-18	BS67	RU 5756-11	BS68
RU 5608-08	BS56	RU 5750-10	BS67	RU 5754-19	BS67	RU 5756-12	BS68
RU 5608-23	BS56	RU 5750-11	BS67	RU 5754-20	BS67	RU 5756-14	BS68
RU 5640-14	BS57	RU 5750-12	BS67	RU 5754-22	BS67	RU 5756-15	BS68
RU 5640-17	BS57	RU 5750-14	BS67	RU 5754-25	BS67	RU 5756-16	BS68
RU 5640-19	BS57	RU 5750-15	BS67	RU 5754-28	BS67	RU 5756-17	BS68
RU 5640-22	BS57	RU 5750-16	BS67	RU 5754-30	BS67	RU 5756-18	BS68
RU 5641-14	BS57	RU 5750-17	BS67	RU 5754-38	BS67	RU 5756-19	BS68
RU 5641-17	BS57	RU 5750-18	BS67	RU 5754-40	BS67	RU 5756-20	BS68
RU 5641-19	BS57	RU 5750-19	BS67	RU 5754-41	BS67	RU 5756-22	BS68
RU 5641-22	BS57	RU 5750-20	BS67	RU 5754-42	BS67	RU 5756-25	BS68
RU 5642-15	BS57	RU 5750-22	BS67	RU 5754-44	BS67	RU 5756-28	BS68
RU 5700-15	BS57	RU 5750-25	BS67	RU 5754-45	BS67	RU 5756-30	BS68
RU 5701-15	BS57	RU 5750-28	BS67	RU 5754-46	BS67	RU 5756-38	BS68
RU 5702-17	BS58	RU 5750-30	BS67	RU 5754-47	BS67	RU 5756-40	BS68
RU 5710-18	BS58	RU 5750-38	BS67	RU 5754-48	BS67	RU 5756-41	BS68
RU 5711-18	BS58	RU 5750-40	BS67	RU 5754-49	BS67	RU 5756-42	BS68
RU 5716-23	BS59	RU 5750-41	BS67	RU 5754-50	BS67	RU 5756-44	BS68
RU 5716-27	BS59	RU 5750-42	BS67	RU 5754-52	BS67	RU 5756-45	BS68
RU 5717-23	BS59	RU 5750-44	BS67	RU 5754-55	BS67	RU 5756-46	BS68
RU 5717-27	BS59	RU 5750-45	BS67	RU 5754-58	BS67	RU 5756-47	BS68
RU 5718-27	BS59	RU 5750-46	BS67	RU 5754-60	BS67	RU 5756-48	BS68
RU 5722-13	BS60	RU 5750-47	BS67	RU 5754-72	BS68	RU 5756-49	BS68
RU 5723-04	BS60	RU 5750-48	BS67	RU 5754-74	BS68	RU 5756-50	BS68
RU 5723-18	BS60	RU 5750-49	BS67	RU 5754-76	BS68	RU 5756-52	BS68
RU 5723-18	BS70	RU 5750-50	BS67	RU 5754-78	BS68	RU 5756-55	BS68
RU 5724-18	BS70	RU 5750-52	BS67	RU 5754-80	BS68	RU 5756-58	BS68
RU 5726-13	BS60	RU 5750-55	BS67	RU 5754-82	BS68	RU 5756-60	BS68
RU 5727-17	BS61	RU 5750-58	BS67	RU 5754-85	BS68	RU 5756-68	BS68
RU 5727-21	BS61	RU 5750-60	BS67	RU 5755-08	BS67	RU 5756-70	BS68
RU 5728-17	BS61	RU 5751-08	BS67	RU 5755-10	BS67	RU 5756-71	BS68
RU 5728-21	BS61	RU 5751-10	BS67	RU 5755-11	BS67	RU 5756-72	BS68
RU 5732-31	BS61	RU 5751-11	BS67	RU 5755-12	BS67	RU 5756-74	BS68
RU 5732-99	BS61	RU 5751-12	BS67	RU 5755-14	BS67	RU 5756-75	BS68
RU 5735-27	BS62	RU 5751-14	BS67	RU 5755-15	BS67	RU 5756-76	BS68
RU 5735-99	BS62	RU 5751-15	BS67	RU 5755-16	BS67	RU 5756-77	BS68
RU 5736-35	BS62	RU 5751-16	BS67	RU 5755-17	BS67	RU 5756-78	BS68
RU 5736-42	BS62	RU 5751-17	BS67	RU 5755-18	BS67	RU 5756-79	BS68
RU 5736-45	BS62	RU 5751-18	BS67	RU 5755-19	BS67	RU 5756-80	BS68
RU 5744-00	BS63	RU 5751-19	BS67	RU 5755-20	BS67	RU 5756-82	BS68
RU 5744-01	BS63	RU 5751-20	BS67	RU 5755-22	BS67	RU 5756-85	BS68
RU 5744-02	BS63	RU 5751-22	BS67	RU 5755-25	BS67	RU 5756-88	BS68
RU 5744-03	BS63	RU 5751-25	BS67	RU 5755-28	BS67	RU 5756-90	BS68
RU 5744-04	BS63	RU 5751-28	BS67	RU 5755-30	BS67	RU 5758-08	BS69
RU 5744-05	BS63	RU 5751-30	BS67	RU 5755-38	BS67	RU 5758-09	BS69
RU 5744-06	BS63	RU 5751-38	BS67	RU 5755-40	BS67	RU 5758-10	BS69
RU 5744-07	BS63	RU 5751-40	BS67	RU 5755-41	BS67	RU 5758-11	BS69
RU 5744-08	BS63	RU 5751-41	BS67	RU 5755-42	BS67	RU 5758-12	BS69
RU 5744-09	BS63	RU 5751-42	BS67	RU 5755-44	BS67	RU 5758-13	BS69
RU 5744-10	BS63	RU 5751-44	BS67	RU 5755-45	BS67	RU 5758-14	BS69
RU 5746-00	BS64	RU 5751-45	BS67	RU 5755-46	BS67	RU 5758-15	BS69
RU 5746-01	BS64	RU 5751-46	BS67	RU 5755-47	BS67	RU 5758-16	BS69
RU 5746-02	BS64	RU 5751-47	BS67	RU 5755-48	BS67	RU 5758-17	BS69
		RU 5751-48	BS67	RU 5755-49	BS67	RU 5758-18	BS69

Nummernverzeichnis

Numerical Index



RU 5758-19	BS69	RU 5784-20	BS69	RU 5851-15	WO3	RU 5924-12	WO10
RU 5758-20	BS69	RU 5784-22	BS69	RU 5851-18	WO3	RU 5927-14	WO10
RU 5758-22	BS69	RU 5784-25	BS69	RU 5852-15	WO3	RU 5928-13	WO10
RU 5758-24	BS69	RU 5784-30	BS69	RU 5852-18	WO3	RU 5928-18	WO10
RU 5758-25	BS69	RU 5785-08	BS69	RU 5853-15	WO3	RU 5929-18	WO11
RU 5758-26	BS69	RU 5785-10	BS69	RU 5853-18	WO3	RU 5930-32	WO4
RU 5758-28	BS69	RU 5785-12	BS69	RU 5854-36	WO4	RU 5930-42	WO4
RU 5758-30	BS69	RU 5785-14	BS69	RU 5854-39	WO4	RU 5930-52	WO4
RU 5759-16	BS72	RU 5785-16	BS69	RU 5854-46	WO4	RU 5931-12	WO6
RU 5760-14	BS70	RU 5785-18	BS69	RU 5854-49	WO4	RU 5931-13	WO6
RU 5760-16	BS70	RU 5785-20	BS69	RU 5860-12	WO4	RU 5931-16	WO6
RU 5761-08	BS71	RU 5785-22	BS69	RU 5860-15	WO4	RU 5931-17	WO6
RU 5761-09	BS71	RU 5785-25	BS69	RU 5860-18	WO4	RU 5931-32	WO6
RU 5761-10	BS71	RU 5785-30	BS69	RU 5860-21	WO4	RU 5931-33	WO6
RU 5761-11	BS71	RU 5786-08	BS69	RU 5860-23	WO4	RU 5931-36	WO6
RU 5761-12	BS71	RU 5786-10	BS69	RU 5860-75	WO5	RU 5931-37	WO6
RU 5761-15	BS72	RU 5786-12	BS69	RU 5860-82	WO5	RU 5931-42	WO6
RU 5761-17	BS70	RU 5786-14	BS69	RU 5860-85	WO5	RU 5931-43	WO6
RU 5761-18	BS70	RU 5786-16	BS69	RU 5860-88	WO5	RU 5931-46	WO6
RU 5761-19	BS70	RU 5786-18	BS69	RU 5861-12	WO4	RU 5931-47	WO6
RU 5761-20	BS70	RU 5786-20	BS69	RU 5861-15	WO4	RU 5950-14	WO7
RU 5761-31	BS72	RU 5786-22	BS69	RU 5861-18	WO4	RU 5951-14	WO7
RU 5761-32	BS72	RU 5786-25	BS69	RU 5861-21	WO4	RU 5952-14	WO7
RU 5761-33	BS72	RU 5786-30	BS69	RU 5861-23	WO4	RU 5953-14	WO7
RU 5761-41	BS71	RU 5797-17	BS79	RU 5861-85	WO5	RU 5956-09	WO7
RU 5761-42	BS71	RU 5797-51	BS79	RU 5861-88	WO5	RU 5956-14	WO7
RU 5762-15	BS74	RU 5798-24	BS79	RU 5862-14T	WO5	RU 5957-09	WO7
RU 5762-18	BS74	RU 5798-51	BS79	RU 5862-15T	WO5	RU 5957-14	WO7
RU 5762-50	BS74	RU 5799-18	BS79	RU 5862-18T	WO5	RU 5958-09	WO7
RU 5764-00	BS73	RU 5799-51	BS79	RU 5862-19T	WO5	RU 5958-14	WO7
RU 5764-51	BS73	RU 5800-23	BS79	RU 5862-34T	WO5	RU 5959-09	WO7
RU 5764-60	BS73	RU 5801-23	BS80	RU 5862-35T	WO5	RU 5959-14	WO7
RU 5765-24	BS74	RU 5802-24	BS80	RU 5862-38T	WO5	RU 5970-01	WO9
RU 5766-12	BS75	RU 5803-10	BS80	RU 5862-39T	WO5	RU 5970-02	WO9
RU 5766-24	BS75	RU 5803-35	BS80	RU 5862-44T	WO5	RU 5970-11	WO8
RU 5767-18	BS75	RU 5803-50	BS80	RU 5862-45T	WO5	RU 5970-12	WO8
RU 5767-22	BS75	RU 5803-70	BS80	RU 5862-48T	WO5	RU 5971-11	WO8
RU 5767-47	BS76	RU 5804-24	BS80	RU 5862-49T	WO5	RU 5971-11T	WO8
RU 5767-57	BS76	RU 5805-18	BS81	RU 5864-12	WO4	RU 5971-12	WO8
RU 5768-18	BS76	RU 5806-24	BS81	RU 5864-15	WO4	RU 5971-12T	WO8
RU 5769-18	BS76	RU 5807-00/01	BS81	RU 5864-18	WO4	RU 5971-14	WO9
RU 5769-22	BS76	RU 5807-00/02	BS81	RU 5864-21	WO4	RU 5973-12	WO8
RU 5769-32	BS76	RU 5807-00/03	BS81	RU 5864-23	WO4	RU 5973-12T	WO8
RU 5770-16	BS77	RU 5808-01	BS82	RU 5865-12	WO4	RU 5973-14	WO9
RU 5770-21	BS77	RU 5808-02	BS82	RU 5865-15	WO4	RU 5973-17	WO8
RU 5773-18	BS77	RU 5808-03	BS82	RU 5865-18	WO4	RU 5973-17T	WO8
RU 5773-27	BS77	RU 5809-19	BS83	RU 5865-21	WO4	RU 5974-10	WO8
RU 5778-02	BS78	RU 5811-23	BS83	RU 5865-23	WO4	RU 5975-10	WO8
RU 5778-03	BS78	RU 5812-19	BS82	RU 5866-12	WO6	RU 5976-10	WO8
RU 5778-04	BS78	RU 5813-01	BS83	RU 5866-13	WO6	RU 5977-10	WO8
RU 5778-05	BS78	RU 5813-02	BS83	RU 5866-14	WO6	RU 5986-14	WO9
RU 5778-06	BS78	RU 5814-16	BS83	RU 5866-15	WO6	RU 5987-14	WO9
RU 5778-07	BS78	RU 5815-16	BS83	RU 5866-32	WO6	RU 5988-14	WO9
RU 5778-08	BS78	RU 5816-17	BS84	RU 5866-33	WO6	RU 6000-14	WO11
RU 5778-09	BS78	RU 5816-20	BS84	RU 5866-34	WO6	RU 6000-16	WO11
RU 5778-10	BS78	RU 5819-18	BS84	RU 5866-35	WO6	RU 6000-18	WO11
RU 5778-12	BS78	RU 5819-19	BS82	RU 5866-42	WO6	RU 6000-20	WO11
RU 5778-15	BS78	RU 5819-20	BS82	RU 5866-43	WO6	RU 6000-24	WO11
RU 5780-01	BS78	RU 5820-19	BS83	RU 5866-44	WO6	RU 6000-26	WO11
RU 5780-02	BS78	RU 5822-01	BS87	RU 5866-45	WO6	RU 6000-30	WO11
RU 5780-03	BS78	RU 5822-02	BS87	RU 5866-52	WO6	RU 6001-16	WO11
RU 5782-00	BS78	RU 5827-15	BS86	RU 5866-53	WO6	RU 6002-21	WO11
RU 5784-08	BS69	RU 5827-18	BS86	RU 5866-54	WO6	RU 6003-16	WO11
RU 5784-10	BS69	RU 5827-20	BS86	RU 5866-55	WO6	RU 6003-18	WO11
RU 5784-12	BS69	RU 5827-21	BS86	RU 5918-13	WO10	RU 6003-20	WO11
RU 5784-14	BS69	RU 5827-35	BS85	RU 5918-18	WO10	RU 6004-16	WO12
RU 5784-16	BS69	RU 5850-15	WO3	RU 5920-13	WO10	RU 6004-18	WO12
RU 5784-18	BS69	RU 5850-18	WO3	RU 5922-12	WO10	RU 6004-20	WO12

Nummernverzeichnis

Numerical Index



RU 6004-21.....	WO 12	RU 6055-01.....	WO 26	RU 6081-14L.....	WO 18	RU 6151-12.....	WO 51
RU 6005-17.....	WO 12	RU 6055-15.....	WO 26	RU 6081-16.....	WO 18	RU 6152-13.....	WO 51
RU 6006-18.....	WO 12	RU 6055-15L.....	WO 26	RU 6081-16L.....	WO 18	RU 6153-14.....	WO 51
RU 6006-26.....	WO 12	RU 6055-18.....	WO 27	RU 6100-20.....	WO 38	RU 6158-01.....	WO 51
RU 6007-27.....	WO 13	RU 6055-18L.....	WO 27	RU 6102-20.....	WO 38	RU 6164-12.....	WO 52
RU 6008-27.....	WO 13	RU 6055-20.....	WO 27	RU 6104-20.....	WO 38	RU 6165-12.....	WO 52
RU 6009-23.....	WO 13	RU 6055-23.....	WO 27	RU 6105-01.....	WO 39	RU 6168-12.....	WO 52
RU 6010-27.....	WO 13	RU 6055-26.....	WO 27	RU 6105-02.....	WO 39	RU 6180-00.....	WO 53
RU 6012-15.....	WO 14	RU 6055-31.....	WO 27	RU 6105-03.....	WO 39	RU 6185-00.....	WO 54
RU 6014-15.....	WO 14	RU 6055-35.....	WO 26	RU 6105-04.....	WO 39	RU 6210-20.....	WO 55
RU 6016-18.....	WO 14	RU 6055-48.....	WO 27	RU 6106-20.....	WO 38	RU 6212-18.....	WO 55
RU 6017-17.....	WO 14	RU 6055-50.....	WO 27	RU 6108-01.....	WO 38	RU 6214-18.....	WO 55
RU 6029-11.....	WO 15	RU 6055-53.....	WO 28	RU 6108-02.....	WO 38	RU 6220-20.....	WO 57
RU 6029-31.....	WO 15	RU 6056-13.....	WO 28	RU 6108-03.....	WO 38	RU 6220-22.....	WO 57
RU 6030-14.....	WO 15	RU 6056-13T.....	WO 28	RU 6108-04.....	WO 38	RU 6220-24.....	WO 57
RU 6030-17.....	WO 16	RU 6056-33.....	WO 28	RU 6110-21.....	WO 40	RU 6220-31.....	WO 58
RU 6030-18.....	WO 15	RU 6057-12.....	WO 29	RU 6110-24.....	WO 40	RU 6220-32.....	WO 58
RU 6031-14.....	WO 16	RU 6058-13.....	WO 29	RU 6110-27.....	WO 41	RU 6220-41.....	WO 58
RU 6032-16.....	WO 17	RU 6059-13.....	WO 30	RU 6110-28.....	WO 41	RU 6220-42.....	WO 58
RU 6032-16L.....	WO 17	RU 6059-16.....	WO 30	RU 6112-21.....	WO 40	RU 6220-51.....	WO 57
RU 6033-14.....	WO 17	RU 6059-16L.....	WO 30	RU 6112-24.....	WO 40	RU 6220-60.....	WO 57
RU 6033-14L.....	WO 17	RU 6059-18.....	WO 30	RU 6112-27.....	WO 41	RU 6220-80.....	WO 58
RU 6040-14.....	WO 35	RU 6059-18L.....	WO 30	RU 6112-28.....	WO 41	RU 6220-81.....	WO 58
RU 6040-17.....	WO 35	RU 6059-20.....	WO 30	RU 6114-21.....	WO 40	RU 6220-82.....	WO 58
RU 6040-20.....	WO 35	RU 6059-23.....	WO 30	RU 6114-27.....	WO 41	RU 6220-83.....	WO 58
RU 6042-14.....	WO 35	RU 6059-26.....	WO 30	RU 6116-21.....	WO 40	RU 6220-84.....	WO 58
RU 6042-17.....	WO 35	RU 6059-29.....	WO 30	RU 6116-27.....	WO 41	RU 6220-85.....	WO 58
RU 6042-20.....	WO 35	RU 6059-30.....	WO 30	RU 6118-15.....	WO 38	RU 6220-86.....	WO 58
RU 6044-01.....	WO 19	RU 6059-31.....	WO 30	RU 6119-15.....	WO 38	RU 6220-87.....	WO 58
RU 6044-03.....	WO 19	RU 6059-32.....	WO 30	RU 6121-01.....	WO 42	RU 6220-88.....	WO 58
RU 6044-13.....	WO 19	RU 6059-39.....	WO 29	RU 6121-21.....	WO 42	RU 6220-89.....	WO 58
RU 6044-13L.....	WO 19	RU 6059-40.....	WO 29	RU 6123-20.....	WO 43	RU 6220-91.....	WO 58
RU 6045-13.....	WO 20	RU 6059-41.....	WO 29	RU 6124-19.....	WO 43	RU 6220-92.....	WO 58
RU 6046-13.....	WO 20	RU 6059-42.....	WO 29	RU 6126-01.....	WO 44	RU 6225-14.....	WO 55
RU 6046-13L.....	WO 20	RU 6059-63.....	WO 31	RU 6126-02.....	WO 44	RU 6230-28.....	WO 55
RU 6047-12.....	WO 20	RU 6059-65.....	WO 31	RU 6126-03.....	WO 44	RU 6234-23.....	WO 56
RU 6048-18.....	WO 21	RU 6059-68.....	WO 31	RU 6126-04.....	WO 44	RU 6240-18.....	WO 56
RU 6049-20.....	WO 21	RU 6059-70.....	WO 31	RU 6127-01.....	WO 44	RU 6240-24.....	WO 56
RU 6049-24.....	WO 21	RU 6059-73.....	WO 31	RU 6127-02.....	WO 44	RU 6296-01.....	RE 1
RU 6049-26.....	WO 21	RU 6059-76.....	WO 31	RU 6127-03.....	WO 44	RU 6296-02.....	RE 1
RU 6050-16.....	WO 22	RU 6060-01.....	WO 31	RU 6127-04.....	WO 44	RU 6297-15.....	RE 1
RU 6050-16L.....	WO 22	RU 6060-02.....	WO 31	RU 6128-01.....	WO 45	RU 6319-10.....	BS 77
RU 6050-18.....	WO 22	RU 6060-03.....	WO 31	RU 6128-02.....	WO 45	RU 6319-11.....	BS 77
RU 6050-18L.....	WO 22	RU 6060-18.....	WO 32	RU 6128-03.....	WO 45	RU 6319-12.....	BS 77
RU 6050-20.....	WO 22	RU 6060-26.....	WO 32	RU 6128-04.....	WO 45	RU 6319-14.....	BS 77
RU 6050-24.....	WO 22	RU 6061-23.....	WO 33	RU 6130-22.....	WO 46	RU 6319-89.....	BS 77
RU 6050-26.....	WO 22	RU 6062-27.....	WO 33	RU 6131-19.....	WO 46	RU 6319-01.....	BS 35
RU 6050-30.....	WO 22	RU 6063-27.....	WO 34	RU 6131-22.....	WO 46	RU 6373-02.....	BS 35
RU 6051-20.....	WO 23	RU 6064-20.....	WO 34	RU 6132-01.....	WO 47	RU 6420-05.....	TS 4
RU 6051-24.....	WO 23	RU 6064-27.....	WO 34	RU 6132-02.....	WO 47	RU 6420-06.....	TS 4
RU 6051-26.....	WO 23	RU 6065-14.....	WO 35	RU 6132-03.....	WO 47	RU 6420-07.....	TS 4
RU 6052-14.....	WO 23	RU 6065-17.....	WO 35	RU 6132-04.....	WO 47	RU 6420-08.....	TS 4
RU 6052-14L.....	WO 23	RU 6065-20.....	WO 35	RU 6133-01.....	WO 47	RU 6420-09.....	TS 4
RU 6053-20.....	WO 24	RU 6066-17.....	WO 36	RU 6133-02.....	WO 47	RU 6420-10.....	TS 4
RU 6053-24.....	WO 24	RU 6066-20.....	WO 36	RU 6133-03.....	WO 47	RU 6420-11.....	TS 4
RU 6054-18.....	WO 25	RU 6070-14.....	WO 36	RU 6133-04.....	WO 47	RU 6420-12.....	TS 4
RU 6054-20.....	WO 25	RU 6070-17.....	WO 36	RU 6134-25.....	WO 48	RU 6420-15.....	TS 4
RU 6054-23.....	WO 25	RU 6070-20.....	WO 36	RU 6136-18.....	WO 48	RU 6420-16.....	TS 4
RU 6054-26.....	WO 25	RU 6072-20.....	WO 37	RU 6136-24.....	WO 48	RU 6420-17.....	TS 4
RU 6054-31.....	WO 25	RU 6072-24.....	WO 37	RU 6136-27.....	WO 48	RU 6420-18.....	TS 4
RU 6054-40.....	WO 25	RU 6073-17.....	WO 37	RU 6139-19.....	WO 49	RU 6420-19.....	TS 4
RU 6054-41.....	WO 25	RU 6073-20.....	WO 37	RU 6140-19.....	WO 49	RU 6420-20.....	TS 4
RU 6054-68.....	WO 25	RU 6079-11.....	WO 15	RU 6141-19.....	WO 49	RU 6420-21.....	TS 4
RU 6054-68L.....	WO 25	RU 6079-31.....	WO 15	RU 6142-19.....	WO 49	RU 6420-22.....	TS 4
RU 6054-70.....	WO 25	RU 6080-14.....	WO 16	RU 6143-20.....	WO 50	RU 6420-23.....	TS 4
RU 6054-73.....	WO 25	RU 6080-17.....	WO 16	RU 6145-23.....	WO 50	RU 6420-24.....	TS 4
RU 6054-76.....	WO 25	RU 6080-18.....	WO 16	RU 6147-23.....	WO 50	RU 6420-25.....	TS 4
RU 6054-81.....	WO 25	RU 6081-14.....	WO 18	RU 6150-12.....	WO 51	RU 6420-26.....	TS 4

Nummernverzeichnis

Numerical Index



RU 6420-27.....	TS 4	RU 6427-03.....	TS 7	RU 6541-25.....	AS 10	RU 6617-21.....	AS 26
RU 6420-28.....	TS 4	RU 6427-04.....	TS 7	RU 6542-25.....	AS 11	RU 6620-00.....	AS 28
RU 6420-29.....	TS 4	RU 6427-100.....	TS 6	RU 6543-25.....	AS 11	RU 6620-10.....	AS 28
RU 6420-30.....	TS 4	RU 6427-130.....	TS 6	RU 6544-30.....	AS 18	RU 6620-11.....	AS 28
RU 6420-31.....	TS 4	RU 6429-01.....	TS 8	RU 6545-31.....	AS 18	RU 6620-16.....	AS 28
RU 6420-32.....	TS 4	RU 6429-02.....	TS 8	RU 6546-26.....	AS 18	RU 6620-51.....	AS 28
RU 6420-33.....	TS 4	RU 6429-30.....	TS 8	RU 6546-28.....	AS 18	RU 6620-51.....	AS 29
RU 6420-34.....	TS 4	RU 6500-15.....	AS 1	RU 6547-24.....	AS 19	RU 6621-00.....	AS 29
RU 6420-35.....	TS 4	RU 6502-15.....	AS 1	RU 6548-24.....	AS 19	RU 6621-12.....	AS 29
RU 6420-36.....	TS 4	RU 6502-19.....	AS 1	RU 6549-24.....	AS 19	RU 6622-00.....	AS 29
RU 6420-37.....	TS 4	RU 6502-23.....	AS 1	RU 6550-13.....	AS 11	RU 6622-05.....	AS 30
RU 6420-38.....	TS 4	RU 6502-25.....	AS 1	RU 6550-22.....	AS 12	RU 6622-19.....	AS 27
RU 6420-39.....	TS 4	RU 6504-12.....	AS 1	RU 6550-25.....	AS 12	RU 6622-21.....	AS 29, AS 30
RU 6420-40.....	TS 4	RU 6504-14.....	AS 1	RU 6550-28.....	AS 12	RU 6630-20.....	AS 35
RU 6420-41.....	TS 4	RU 6505-16.....	AS 2	RU 6551-13.....	AS 11	RU 6630-22.....	AS 35
RU 6420-42.....	TS 4	RU 6505-20.....	AS 2	RU 6551-22.....	AS 12	RU 6630-24.....	AS 35
RU 6420-43.....	TS 4	RU 6505-22.....	AS 2	RU 6551-25.....	AS 12	RU 6631-23.....	AS 35
RU 6420-44.....	TS 4	RU 6505-25.....	AS 2	RU 6551-28.....	AS 12	RU 6631-24.....	AS 35
RU 6420-45.....	TS 4	RU 6505-30.....	AS 2	RU 6552-22.....	AS 13	RU 6632-23.....	AS 35
RU 6420-46.....	TS 4	RU 6506-15.....	AS 2	RU 6552-25.....	AS 13	RU 6640-01.....	AS 36
RU 6420-47.....	TS 4	RU 6508-15.....	AS 2	RU 6552-28.....	AS 13	RU 6640-02.....	AS 36
RU 6420-48.....	TS 4	RU 6509-16.....	AS 2	RU 6553-22.....	AS 13	RU 6640-03.....	AS 36
RU 6420-49.....	TS 4	RU 6509-20.....	AS 2	RU 6553-25.....	AS 13	RU 6640-04.....	AS 36
RU 6420-50.....	TS 4	RU 6510-20.....	AS 3	RU 6553-28.....	AS 13	RU 6642-00.....	AS 31
RU 6420-51.....	TS 4	RU 6512-15.....	AS 3	RU 6557-15.....	AS 14	RU 6642-01.....	AS 31
RU 6420-56.....	TS 5	RU 6512-19.....	AS 3	RU 6558-15.....	AS 14	RU 6642-02.....	AS 31
RU 6420-58.....	TS 5	RU 6513-18.....	AS 3	RU 6558-20.....	AS 14	RU 6644-21.....	AS 32
RU 6420-60.....	TS 5	RU 6514-16.....	AS 6	RU 6559-12.....	AS 14	RU 6657-23.....	AS 32
RU 6420-62.....	TS 5	RU 6515-20.....	AS 3	RU 6562-21.....	AS 15	RU 6658-23.....	AS 32
RU 6420-65.....	TS 5	RU 6517-16.....	AS 4	RU 6562-29.....	AS 15	RU 6665-00.....	AS 33
RU 6420-76.....	TS 5	RU 6517-20.....	AS 4	RU 6562-35.....	AS 15	RU 6665-01.....	AS 33
RU 6420-78.....	TS 5	RU 6518-16.....	AS 4	RU 6570-30.....	AS 16	RU 6665-02.....	AS 33
RU 6420-80.....	TS 5	RU 6518-18.....	AS 4	RU 6571-30.....	AS 16	RU 6665-03.....	AS 33
RU 6420-82.....	TS 5	RU 6518-20.....	AS 4	RU 6580-00.....	AS 17	RU 6665-04.....	AS 33
RU 6420-85.....	TS 5	RU 6518-24.....	AS 4	RU 6580-05.....	AS 17	RU 6665-05.....	AS 33
RU 6421-06.....	TS 5	RU 6519-16.....	AS 4	RU 6580-07.....	AS 17	RU 6665-06.....	AS 33
RU 6421-07.....	TS 5	RU 6519-20.....	AS 4	RU 6580-10.....	AS 17	RU 6665-07.....	AS 33
RU 6421-08.....	TS 5	RU 6520-18.....	AS 5	RU 6580-20.....	AS 17	RU 6665-08.....	AS 33
RU 6421-09.....	TS 5	RU 6520-20.....	AS 5	RU 6580-23.....	AS 17	RU 6665-09.....	AS 33
RU 6421-10.....	TS 5	RU 6521-18.....	AS 5	RU 6590-22.....	AS 20	RU 6665-10.....	AS 33
RU 6421-11.....	TS 5	RU 6521-20.....	AS 5	RU 6591-20.....	AS 20	RU 6665-11.....	AS 33
RU 6421-12.....	TS 5	RU 6521-23.....	AS 5	RU 6592-15.....	AS 20	RU 6665-12.....	AS 33
RU 6421-15.....	TS 5	RU 6522-20.....	AS 6	RU 6593-15.....	AS 20	RU 6665-13.....	AS 33
RU 6421-34.....	TS 4	RU 6522-23.....	AS 6	RU 6595-08.....	AS 21	RU 6665-50.....	AS 33
RU 6424-20.....	TS 9	RU 6523-20.....	AS 6	RU 6596-19.....	AS 21	RU 6665-71.....	AS 33
RU 6424-21.....	TS 9	RU 6525-25.....	AS 6	RU 6597-17.....	AS 21	RU 6670-02.....	AS 33
RU 6424-22.....	TS 9	RU 6525-26.....	AS 6	RU 6598-15.....	AS 22	RU 6670-03.....	AS 33
RU 6424-40.....	TS 9	RU 6530-18.....	AS 7	RU 6604-00.....	AS 23	RU 6670-04.....	AS 33
RU 6424-41.....	TS 9	RU 6530-21.....	AS 7	RU 6605-01.....	AS 23	RU 6675-02.....	AS 34
RU 6426-21.....	TS 5	RU 6530-23.....	AS 7	RU 6605-02.....	AS 23	RU 6675-03.....	AS 34
RU 6426-50.....	TS 6	RU 6531-18.....	AS 7	RU 6605-03.....	AS 23	RU 6675-04.....	AS 34
RU 6426-51.....	TS 6	RU 6531-21.....	AS 7	RU 6605-04.....	AS 23	RU 6675-05.....	AS 34
RU 6426-52.....	TS 6	RU 6531-23.....	AS 7	RU 6606-01.....	AS 23	RU 6675-06.....	AS 34
RU 6426-53.....	TS 6	RU 6534-13.....	AS 8	RU 6606-02.....	AS 23	RU 6675-08.....	AS 34
RU 6426-54.....	TS 6	RU 6534-16.....	AS 8	RU 6608-00.....	AS 24	RU 6675-11.....	AS 34
RU 6426-55.....	TS 6	RU 6534-18.....	AS 8	RU 6608-01.....	AS 24	RU 6675-15.....	AS 34
RU 6426-56.....	TS 6	RU 6534-21.....	AS 8	RU 6608-20.....	AS 24	RU 6690-21.....	AS 39
RU 6426-57.....	TS 6	RU 6534-23.....	AS 8	RU 6608-27.....	AS 24	RU 6691-22.....	AS 39
RU 6426-60.....	TS 6	RU 6535-13.....	AS 8	RU 6610-28.....	AS 25	RU 6692-22.....	AS 39
RU 6426-61.....	TS 6	RU 6535-16.....	AS 8	RU 6610-35.....	AS 25	RU 6693-22.....	AS 39
RU 6426-62.....	TS 6	RU 6535-18.....	AS 8	RU 6610-42.....	AS 25	RU 6696-80.....	AS 40
RU 6426-63.....	TS 6	RU 6535-21.....	AS 8	RU 6611-28.....	AS 25	RU 6696-81.....	AS 40
RU 6426-64.....	TS 6	RU 6535-23.....	AS 8	RU 6611-35.....	AS 25	RU 6700-00.....	AS 40
RU 6426-65.....	TS 6	RU 6540-21.....	AS 9	RU 6611-42.....	AS 25	RU 6702-00.....	AS 37
RU 6426-66.....	TS 6	RU 6540-23.....	AS 9	RU 6616-20.....	AS 26	RU 6703-00.....	AS 38
RU 6426-67.....	TS 6	RU 6540-25.....	AS 10	RU 6616-20.....	GO 34	RU 6706-00.....	AS 38
RU 6427-01.....	TS 7	RU 6541-21.....	AS 9				
RU 6427-02.....	TS 7	RU 6541-23.....	AS 9				

Nummernverzeichnis

Numerical Index



RU 6710-08.....AS 41	RU 7025-05.....GO 5	RU 7078-11.....GO 7	RU 7100-06.....GO 22
RU 6710-10.....AS 41	RU 7026-01.....GO 5	RU 7078-12.....GO 7	RU 7100-07.....GO 22
RU 6710-12.....AS 41	RU 7026-02.....GO 5	RU 7078-21.....GO 7	RU 7100-08.....GO 22
RU 6710-14.....AS 41	RU 7026-03.....GO 5	RU 7078-22.....GO 7	RU 7100-09.....GO 22
RU 6710-16.....AS 41	RU 7040-00.....GO 5	RU 7080-01.....GO 16	RU 7100-10.....GO 22
RU 6710-18.....AS 41	RU 7049-01.....GO 6	RU 7080-02.....GO 16	RU 7100-11.....GO 22
RU 6710-20.....AS 41	RU 7049-02.....GO 6	RU 7080-03.....GO 16	RU 7100-12.....GO 22
RU 6710-22.....AS 41	RU 7049-03.....GO 6	RU 7080-11.....GO 15	RU 7100-13.....GO 22
RU 6710-24.....AS 41	RU 7050-00.....GO 6	RU 7080-12.....GO 15	RU 7100-14.....GO 22
RU 6710-26.....AS 41	RU 7050-01.....GO 6	RU 7080-13.....GO 15	RU 7100-15.....GO 22
RU 6710-28.....AS 41	RU 7050-02.....GO 6	RU 7081-01.....GO 16	RU 7100-16.....GO 22
RU 6710-30.....AS 41	RU 7050-03.....GO 6	RU 7081-02.....GO 16	RU 7100-17.....GO 22
RU 6710-32.....AS 41	RU 7055-01.....GO 7	RU 7081-03.....GO 16	RU 7100-18.....GO 22
RU 6710-34.....AS 41	RU 7055-02.....GO 7	RU 7081-04.....GO 16	RU 7100-19.....GO 22
RU 6710-36.....AS 41	RU 7055-03.....GO 7	RU 7082-01.....GO 16	RU 7100-20.....GO 22
RU 6715-08.....AS 41	RU 7056-01.....GO 7	RU 7082-02.....GO 16	RU 7100-21.....GO 22
RU 6715-10.....AS 41	RU 7056-02.....GO 7	RU 7082-03.....GO 16	RU 7100-22.....GO 22
RU 6715-12.....AS 41	RU 7056-03.....GO 7	RU 7082-04.....GO 16	RU 7100-23.....GO 22
RU 6715-14.....AS 41	RU 7060-00.....GO 8	RU 7083-01.....GO 17	RU 7100-24.....GO 22
RU 6716-08.....AS 41	RU 7060-01.....GO 9	RU 7083-02.....GO 17	RU 7100-25.....GO 22
RU 6716-10.....AS 41	RU 7060-02.....GO 9	RU 7083-03.....GO 17	RU 7100-26.....GO 22
RU 6716-12.....AS 41	RU 7060-03.....GO 9	RU 7084-01.....GO 17	RU 7100-27.....GO 22
RU 6716-14.....AS 41	RU 7060-11.....GO 9	RU 7084-02.....GO 17	RU 7100-28.....GO 22
RU 6716-16.....AS 41	RU 7060-12.....GO 9	RU 7084-03.....GO 17	RU 7100-29.....GO 22
RU 6716-18.....AS 41	RU 7060-13.....GO 9	RU 7085-01.....GO 17	RU 7100-30.....GO 22
RU 6718-39.....AS 42	RU 7060-21.....GO 9	RU 7085-02.....GO 17	RU 7101-01.....GO 22
RU 6719-35.....AS 42	RU 7060-22.....GO 9	RU 7085-03.....GO 17	RU 7101-02.....GO 22
RU 6723-01.....AS 42	RU 7060-23.....GO 9	RU 7086-01.....GO 19	RU 7101-03.....GO 22
RU 6725-08.....AS 42	RU 7060-30.....GO 8	RU 7086-02.....GO 19	RU 7101-04.....GO 22
RU 6725-11.....AS 42	RU 7060-40.....GO 8	RU 7086-25.....GO 19	RU 7101-05.....GO 22
RU 6725-13.....AS 42	RU 7065-01.....GO 10	RU 7088-00.....GO 20	RU 7101-06.....GO 22
RU 6725-16.....AS 42	RU 7065-02.....GO 10	RU 7088-10.....GO 20	RU 7101-07.....GO 22
RU 6725-21.....AS 42	RU 7065-11.....GO 10	RU 7088-51.....GO 20	RU 7101-08.....GO 22
RU 6725-26.....AS 42	RU 7065-12.....GO 10	RU 7088-52.....GO 20	RU 7101-09.....GO 22
RU 6725-32.....AS 42	RU 7065-21.....GO 10	RU 7090-20.....GO 18	RU 7101-10.....GO 22
RU 6727-20.....AS 43	RU 7065-22.....GO 10	RU 7090-25.....GO 18	RU 7101-11.....GO 22
RU 6730-00.....AS 43	RU 7070-01.....GO 11	RU 7090-30.....GO 18	RU 7101-12.....GO 22
RU 6732-00.....AS 43	RU 7070-02.....GO 11	RU 7090-35.....GO 18	RU 7101-13.....GO 22
RU 6735-26.....AS 43	RU 7070-03.....GO 11	RU 7090-40.....GO 18	RU 7101-14.....GO 22
RU 6735-26.....GO 37	RU 7070-11.....GO 11	RU 7091-20.....GO 18	RU 7101-15.....GO 22
RU 7000-01.....GO 3	RU 7070-12.....GO 11	RU 7091-25.....GO 18	RU 7101-16.....GO 22
RU 7000-02.....GO 3	RU 7070-13.....GO 11	RU 7091-30.....GO 18	RU 7101-17.....GO 22
RU 7000-03.....GO 3	RU 7070-21.....GO 11	RU 7091-35.....GO 18	RU 7101-18.....GO 22
RU 7001-01.....GO 3	RU 7070-22.....GO 11	RU 7091-40.....GO 18	RU 7101-19.....GO 22
RU 7001-02.....GO 3	RU 7070-23.....GO 11	RU 7092-20.....GO 18	RU 7102-02.....GO 22
RU 7001-03.....GO 3	RU 7072-01.....GO 12	RU 7092-25.....GO 18	RU 7102-04.....GO 22
RU 7002-00.....GO 2	RU 7072-02.....GO 12	RU 7092-30.....GO 18	RU 7102-06.....GO 22
RU 7003-00.....GO 2	RU 7072-03.....GO 12	RU 7092-35.....GO 18	RU 7102-08.....GO 22
RU 7004-01.....GO 2	RU 7072-11.....GO 12	RU 7092-40.....GO 18	RU 7102-10.....GO 22
RU 7004-02.....GO 2	RU 7072-12.....GO 12	RU 7093-20.....GO 18	RU 7102-12.....GO 22
RU 7004-03.....GO 2	RU 7072-13.....GO 12	RU 7093-25.....GO 18	RU 7102-14.....GO 22
RU 7020-01.....GO 1	RU 7072-21.....GO 12	RU 7093-30.....GO 18	RU 7102-16.....GO 22
RU 7020-02.....GO 1	RU 7072-22.....GO 12	RU 7093-35.....GO 18	RU 7102-18.....GO 22
RU 7020-03.....GO 1	RU 7072-23.....GO 12	RU 7093-40.....GO 18	RU 7102-20.....GO 22
RU 7020-10.....GO 1	RU 7073-01.....GO 13	RU 7095-00.....GO 21	RU 7102-22.....GO 22
RU 7020-11.....GO 1	RU 7073-02.....GO 13	RU 7095-01.....GO 21	RU 7102-24.....GO 22
RU 7022-01.....GO 4	RU 7073-03.....GO 13	RU 7095-02.....GO 21	RU 7102-26.....GO 22
RU 7022-02.....GO 4	RU 7073-04.....GO 13	RU 7095-03.....GO 21	RU 7102-30.....GO 22
RU 7022-03.....GO 4	RU 7073-05.....GO 13	RU 7095-04.....GO 21	RU 7102-40.....GO 22
RU 7023-01.....GO 4	RU 7073-11.....GO 13	RU 7095-05.....GO 21	RU 7120-34.....GO 23
RU 7023-02.....GO 4	RU 7073-12.....GO 13	RU 7095-10.....GO 21	RU 7123-00.....GO 23
RU 7023-03.....GO 4	RU 7073-13.....GO 13	RU 7095-12.....GO 21	RU 7124-00.....GO 23
RU 7024-01.....GO 5	RU 7073-14.....GO 13	RU 7095-14.....GO 21	RU 7125-00.....GO 23
RU 7024-02.....GO 5	RU 7073-15.....GO 13	RU 7100-01.....GO 22	RU 7125-01.....GO 23
RU 7024-03.....GO 5	RU 7074-00.....GO 14	RU 7100-02.....GO 22	RU 7128-00.....GO 24
RU 7025-01.....GO 5	RU 7075-00.....GO 14	RU 7100-03.....GO 22	RU 7128-10.....GO 24
RU 7025-02.....GO 5	RU 7078-01.....GO 7	RU 7100-04.....GO 22	RU 7130-32.....GO 24
RU 7025-03.....GO 5	RU 7078-02.....GO 7	RU 7100-05.....GO 22	RU 7131-32.....GO 24

Nummernverzeichnis

Numerical Index



RU 7133-32	GO 24	RU 7263-21	GO 48	RU 7302-01	GO 56	RU 7322-07	GO 57
RU 7134-32	GO 24	RU 7263-58	GO 49	RU 7302-02	GO 56	RU 7322-08	GO 57
RU 7135-25	GO 24	RU 7264-00	GO 49	RU 7302-03	GO 56	RU 7322-09	GO 57
RU 7138-27	GO 24	RU 7264-10/20	GO 50	RU 7302-04	GO 56	RU 7322-11	GO 57
RU 7150-00	GO 25	RU 7264-10/25	GO 50	RU 7302-05	GO 56	RU 7322-12	GO 57
RU 7153-00	GO 25	RU 7264-10/30	GO 50	RU 7302-06	GO 56	RU 7322-14	GO 57
RU 7157-24	GO 26	RU 7265-00	GO 50	RU 7304-01	GO 56	RU 7322-15	GO 57
RU 7158-27	GO 26	RU 7265-00P	GO 50	RU 7304-02	GO 56	RU 7322-16	GO 57
RU 7159-03	GO 26	RU 7265-06	GO 50	RU 7304-03	GO 56	RU 7322-19	GO 57
RU 7160-25	GO 26	RU 7265-06P	GO 50	RU 7304-04	GO 56	RU 7322-20	GO 57
RU 7162-25	GO 27	RU 7266-00	GO 50	RU 7304-05	GO 56	RU 7322-21	GO 57
RU 7164-25	GO 27	RU 7266-00P	GO 50	RU 7304-06	GO 56	RU 7322-23	GO 57
RU 7165-26	GO 27	RU 7267-00	GO 50	RU 7306-01	GO 56	RU 7322-25	GO 57
RU 7166-28	GO 27	RU 7267-00P	GO 50	RU 7306-02	GO 56	RU 7322-30	GO 57
RU 7167-20	GO 28	RU 7270-00	GO 51	RU 7306-03	GO 56	RU 7322-35	GO 57
RU 7168-24	GO 28	RU 7270-00P	GO 51	RU 7306-04	GO 56	RU 7322-40	GO 57
RU 7170-26	GO 28	RU 7270-50	GO 51	RU 7306-05	GO 56	RU 7324-05	GO 57
RU 7175-20	GO 28	RU 7270-50P	GO 51	RU 7306-06	GO 56	RU 7324-06	GO 57
RU 7178-26	GO 29	RU 7271-00	GO 52	RU 7310-05	GO 56	RU 7324-07	GO 57
RU 7180-20	GO 30	RU 7272-00	GO 52	RU 7310-06	GO 56	RU 7324-08	GO 57
RU 7180-24	GO 30	RU 7273-00	GO 52	RU 7310-07	GO 56	RU 7324-09	GO 57
RU 7181-20	GO 30	RU 7275-00	GO 53	RU 7310-08	GO 56	RU 7324-11	GO 57
RU 7181-24	GO 30	RU 7275-10	GO 53	RU 7310-09	GO 56	RU 7324-12	GO 57
RU 7182-20	GO 30	RU 7275-11	GO 53	RU 7310-11	GO 56	RU 7324-14	GO 57
RU 7182-24	GO 30	RU 7275-70	GO 53	RU 7310-12	GO 56	RU 7324-15	GO 57
RU 7189-20	GO 31	RU 7275-71	GO 53	RU 7310-14	GO 56	RU 7324-16	GO 57
RU 7190-06	GO 31	RU 7275-80	GO 53	RU 7310-15	GO 56	RU 7324-19	GO 57
RU 7190-08	GO 31	RU 7275-81	GO 53	RU 7310-16	GO 56	RU 7324-20	GO 57
RU 7190-10	GO 31	RU 7280-01	GO 54	RU 7314-05	GO 56	RU 7324-21	GO 57
RU 7191-06	GO 32	RU 7280-02	GO 54	RU 7314-06	GO 56	RU 7324-23	GO 57
RU 7191-08	GO 32	RU 7280-03	GO 54	RU 7314-07	GO 56	RU 7324-25	GO 57
RU 7191-10	GO 32	RU 7280-04	GO 54	RU 7314-08	GO 56	RU 7324-30	GO 57
RU 7197-16	GO 29	RU 7280-05	GO 54	RU 7314-09	GO 56	RU 7324-35	GO 57
RU 7200-23	GO 32	RU 7280-06	GO 54	RU 7314-11	GO 56	RU 7324-40	GO 57
RU 7210-21	GO 32	RU 7281-01	GO 55	RU 7314-12	GO 56	RU 7330-27	GO 57
RU 7212-24	GO 33	RU 7281-02	GO 55	RU 7314-14	GO 56	RU 7350-00	GO 59
RU 7214-26	GO 33	RU 7281-03	GO 55	RU 7314-15	GO 56	RU 7350-01	GO 59
RU 7215-32	GO 33	RU 7281-04	GO 55	RU 7314-16	GO 56	RU 7350-02	
RU 7216-24	GO 33	RU 7281-05	GO 55	RU 7316-05	GO 56 GO 59, GO 60	
RU 7218-25	GO 34	RU 7282-01	GO 54	RU 7316-06	GO 56	RU 7350-03	
RU 7219-27	GO 34	RU 7282-02	GO 54	RU 7316-07	GO 56 GO 59, GO 60	
RU 7222-27	GO 35	RU 7282-03	GO 54	RU 7316-08	GO 56	RU 7350-04	
RU 7223-23	GO 35	RU 7282-04	GO 54	RU 7316-09	GO 56 GO 59, GO 60	
RU 7224-25	GO 35	RU 7283-01	GO 55	RU 7316-11	GO 56	RU 7350-05	
RU 7225-28	GO 35	RU 7283-02	GO 55	RU 7316-12	GO 56 GO 59, GO 60	
RU 7226-18	GO 36	RU 7283-03	GO 55	RU 7316-14	GO 56	RU 7350-06	
RU 7226-20	GO 36	RU 7283-04	GO 55	RU 7316-15	GO 56 GO 59, GO 60	
RU 7230-22	GO 37	RU 7283-05	GO 55	RU 7316-16	GO 56	RU 7360-00	GO 60
RU 7231-22	GO 37	RU 7283-06	GO 55	RU 7318-05	GO 57	RU 7410-01	GO 66
RU 7239-17	GO 37	RU 7284-00	GO 25	RU 7318-06	GO 57	RU 7410-02	GO 66
RU 7243-04	GO 44	RU 7286-24	GO 55	RU 7318-07	GO 57	RU 7410-03	GO 66
RU 7245-01	GO 44	RU 7287-24	GO 55	RU 7318-08	GO 57	RU 7411-01	GO 66
RU 7245-02	GO 44	RU 7289-04	GO 58	RU 7318-09	GO 57	RU 7411-02	GO 66
RU 7245-03	GO 44	RU 7289-06	GO 58	RU 7318-11	GO 57	RU 7411-03	GO 66
RU 7245-04	GO 44	RU 7289-08	GO 58	RU 7318-12	GO 57	RU 7413-25	GO 67
RU 7245-51	GO 44	RU 7289-10	GO 58	RU 7318-14	GO 57	RU 7414-27	GO 67
RU 7246-30	GO 45	RU 7289-12	GO 58	RU 7318-15	GO 57	RU 7415-27	GO 67
RU 7246-51	GO 45	RU 7289-14	GO 58	RU 7318-16	GO 57	RU 7418-21	GO 68
RU 7247-30	GO 45	RU 7289-50	GO 58	RU 7318-19	GO 57	RU 7419-26	GO 61
RU 7252-24	GO 46	RU 7290-05	GO 58	RU 7318-20	GO 57	RU 7420-19	GO 61
RU 7255-21	GO 46	RU 7290-07	GO 58	RU 7318-21	GO 57	RU 7425-28	GO 61
RU 7255-29	GO 46	RU 7290-09	GO 58	RU 7318-23	GO 57	RU 7432-25	GO 62
RU 7256-26	GO 46	RU 7300-01	GO 56	RU 7318-25	GO 57	RU 7436-29	GO 62
RU 7257-27	GO 47	RU 7300-02	GO 56	RU 7318-30	GO 57	RU 7440-36	GO 64
RU 7258-01	GO 47	RU 7300-03	GO 56	RU 7318-35	GO 57	RU 7440-40	GO 64
RU 7258-25	GO 47	RU 7300-04	GO 56	RU 7318-40	GO 57	RU 7442-28	GO 63
RU 7261-24	GO 47	RU 7300-05	GO 56	RU 7322-05	GO 57	RU 7445-23	GO 63
RU 7262-24	GO 47	RU 7300-06	GO 56	RU 7322-06	GO 57	RU 7445-30	GO 63

Nummernverzeichnis

Numerical Index



RU 7446-36.....	GO 64	RU 8125-18.....	BS 58	RU 8984-01.....	HS 5
RU 7447-36.....	GO 63	RU 8206-16.....	BS 20	RU 8984-02.....	HS 5
RU 7460-41.....	GO 64	RU 8210-19.....	BS 20	RU 8984-03.....	HS 5
RU 7463-36.....	GO 64	RU 8253-02.....	BS 3	RU 8984-04.....	HS 5
RU 7472-44.....	GO 65	RU 8253-04.....	BS 3	RU 8984-05.....	HS 5
RU 7474-43.....	GO 65	RU 8253-06.....	BS 3	RU 8984-06.....	HS 5
RU 7580-01T.....	FC 22	RU 8253-07.....	BS 3	RU 8984-07.....	HS 5
RU 7580-02T.....	FC 22	RU 8253-09.....	BS 3	RU 8985-01.....	HS 5
RU 7580-03T.....	FC 22	RU 8253-12.....	BS 3	RU 8985-02.....	HS 5
RU 7580-16.....	FC 22	RU 8258-04.....	BS 3	RU 8985-03.....	HS 5
RU 7580-16T.....	FC 22	RU 8258-06.....	BS 3	RU 8985-04.....	HS 5
RU 7580-20.....	FC 22	RU 8258-07.....	BS 3	RU 8985-05.....	HS 5
RU 7580-20T.....	FC 22	RU 8258-09.....	BS 3	RU 8985-06.....	HS 5
RU 7580-24.....	FC 22	RU 8258-12.....	BS 3	RU 8985-10.....	HS 5
RU 7580-24T.....	FC 22	RU 8450-16.....	CF 57	RU 8985-11.....	HS 5
RU 7580-30.....	FC 22	RU 8906-31.....	HS 15	RU 8986-12.....	HS 6
RU 7581-01T.....	FC 22	RU 8906-32.....	HS 15	RU 8986-14.....	HS 6
RU 7581-02T.....	FC 22	RU 8906-33.....	HS 15	RU 8986-16.....	HS 6
RU 7581-03T.....	FC 22	RU 8906-34.....	HS 15	RU 8987-01.....	HS 6
RU 7581-16.....	FC 22	RU 8906-35.....	HS 15	RU 8987-02.....	HS 6
RU 7581-20.....	FC 22	RU 8906-36.....	HS 15	RU 8987-03.....	HS 6
RU 7581-24.....	FC 22	RU 8906-37.....	HS 15	RU 8987-04.....	HS 6
RU 7581-30.....	FC 22	RU 8906-38.....	HS 15	RU 8987-05.....	HS 6
RU 7582-01T.....	FC 22	RU 8906-39.....	HS 15	RU 8987-06.....	HS 6
RU 7582-02T.....	FC 22	RU 8941-55.....	HS 1	RU 8988-01.....	HS 6
RU 7582-03T.....	FC 22	RU 8945-20.....	HS 1	RU 8988-02.....	HS 6
RU 7582-16.....	FC 22	RU 8945-30.....	HS 1	RU 8988-03.....	HS 6
RU 7582-16T.....	FC 22	RU 8947-27.....	HS 1	RU 8988-04.....	HS 6
RU 7582-20.....	FC 22	RU 8948-20.....	HS 1	RU 8988-05.....	HS 6
RU 7582-20T.....	FC 22	RU 8950-01.....	HS 1	RU 8988-06.....	HS 6
RU 7582-24.....	FC 22	RU 8950-02.....	HS 1	RU 8988-07.....	HS 6
RU 7582-24T.....	FC 22	RU 8950-03.....	HS 1	RU 8988-08.....	HS 6
RU 7582-30.....	FC 22	RU 8960-05.....	HS 2	RU 8988-09.....	HS 6
RU 7583-16.....	FC 22	RU 8961-01.....	HS 2	RU 8989-00.....	HS 8
RU 7583-20.....	FC 22	RU 8961-02.....	HS 2		
RU 7583-24.....	FC 22	RU 8964-02.....	HS 3		
RU 7583-30.....	FC 22	RU 8964-05.....	HS 3		
RU 7584-16.....	FC 22	RU 8964-10.....	HS 3		
RU 7584-20.....	FC 22	RU 8964-15.....	HS 3		
RU 7584-24.....	FC 22	RU 8964-20.....	HS 3		
RU 7584-30.....	FC 22	RU 8970-01.....	HS 3		
RU 7585-12.....	FC 12	RU 8970-02.....	HS 3		
RU 7585-15.....	FC 12	RU 8970-03.....	HS 3		
RU 7845-03.....	TS 7	RU 8972-01.....	HS 4		
RU 7845-05.....	TS 7	RU 8972-02.....	HS 4		
RU 7845-07.....	TS 7	RU 8972-03.....	HS 4		
RU 7845-20.....	TS 7	RU 8972-04.....	HS 4		
RU 7845-22.....	TS 7	RU 8975-05.....	HS 4		
RU 7845-24.....	TS 7	RU 8975-10.....	HS 4		
RU 7860-11.....	FC 24	RU 8975-10/10.....	HS 4		
RU 7860-12.....	FC 24	RU 8975-10/25.....	HS 4		
RU 7860-15.....	FC 24	RU 8976-20.....	HS 4		
RU 7860-18.....	FC 24	RU 8977-01.....	HS 7		
RU 7861-12.....	FC 24	RU 8977-02.....	HS 7		
RU 7862-14.....	FC 23	RU 8977-03.....	HS 7		
RU 7862-24.....	FC 23	RU 8977-04.....	HS 7		
RU 7863-14.....	FC 23	RU 8977-05.....	HS 7		
RU 7863-15.....	FC 23	RU 8977-06.....	HS 7		
RU 7864-16.....	FC 23	RU 8978-01.....	HS 7		
RU 7864-18.....	FC 23	RU 8978-02.....	HS 7		
RU 7864-20.....	FC 23	RU 8978-04.....	HS 7		
RU 7864-26.....	FC 23	RU 8979-00.....	HS 7		
RU 7864-28.....	FC 23	RU 8980-01.....	HS 8		
RU 7864-30.....	FC 23	RU 8980-02.....	HS 8		
RU 7865-16.....	FC 23	RU 8980-03.....	HS 8		
RU 7865-20.....	FC 23	RU 8980-04.....	HS 8		
RU 7866-12.....	FC 24	RU 8980-05.....	HS 8		
RU 7921-15.....	BS 15	RU 8980-06.....	HS 8		



RUDOLF Medical GmbH + Co. KG
 Zollerstraße 1, 78567 Fridingen, Germany
 Tel +49 7463 9956-0, Fax +49 7463 9956-56
 sales@rudolf-med.com, www.rudolf-med.com



Produkt Kennzeichen	<i>Product Characteristics</i>	SC 1 – 5, 51
Mikro Federscheren	<i>Micro Spring Scissors</i>	SC 7 – 10
Feine Scheren	<i>Delicate Scissors</i>	SC 11 – 15
Feine chirurgische Scheren	<i>Delicate Surgical Scissors</i>	SC 16 – 17
Chirurgische Scheren	<i>Surgical Scissors</i>	SC 18 – 21
Feine Präparierscheren	<i>Delicate Dissecting Scissors</i>	SC 22 – 25
Präparierscheren	<i>Dissecting Scissors</i>	SC 26 – 36, 38 – 45
Bipolare Scheren	<i>Bipolar Scissors</i>	SC 46
Nasenscheren	<i>Nasal Scissors</i>	SC 47 – 48
Gefäßscheren	<i>Vascular Scissors</i>	SC 49 – 51, 53 – 54
Neurochirurgische Scheren	<i>Neurosurgical Scissors</i>	SC 55
Tonsillen-Scheren	<i>Tonsil Scissors</i>	SC 56 – 57
Darmscheren	<i>Enterotomy Scissors</i>	SC 58
Ligaturscheren	<i>Ligature Scissors</i>	SC 45, 59 – 60
Gynäkologische Scheren	<i>Gynecological Scissors</i>	SC 61 – 63
Nabelschnurscheren	<i>Umbilical Scissors</i>	SC 64
Damm-(Episiotomie-) Scheren	<i>Perineum (Episiotomy) Scissors</i>	SC 65
Parametriumscheren	<i>Parametrium Scissors</i>	SC 66
Kronenscheren	<i>Crown Scissors</i>	SC 67
Zahnfleischscheren	<i>Gum Scissors</i>	SC 68
Nagelscheren	<i>Nail Scissors</i>	SC 69
Drahtscheren	<i>Wire Cutting Scissors</i>	SC 70
Verbandscheren	<i>Bandage Scissors</i>	SC 71 – 74
Gippscheren	<i>Plaster Shears</i>	SC 75
Knochenscheren	<i>Bone Scissors</i>	SC 75
Rippenschere	<i>Rib Shears</i>	SC 76



Standard-Schere

- hergestellt aus hochwertigem Edelstahl



Standard Scissors

- manufactured of high grade stainless steel

SuperCut-Schere

- unteres Blatt mit rasiermesserscharfer Schneide
- oberes Blatt mikrofein gezahnt

Erkennungsmerkmale:

- + schwarze Ringe und
- + zusätzlich endet die Artikelnummer mit dem Buchstaben "M"



SuperCut Scissors

- lower blade with razor-sharp cutting edge
- microfine serrated upper blade

Identifying features:

- + black rings
- + the article number ends with the letter "M"



Hartmetallschere

- Schneiden mit aufgeschweißtem Hartmetall

Erkennungsmerkmale:

- + vergoldete Ringe



Hard Metal Scissors

- blades with welded hard metal

Identifying features:

- + gold plated rings





Hartmetall-SuperCut-Schere

- Schneiden mit aufgeschweißtem Hartmetall
- unteres Blatt mit rasiermesserscharfer Schneide und oberes Blatt mikrofein gezahnt (MC)

Erkennungsmerkmale:

- + lang vergoldete Ringe
- + die Artikelnummer endet mit dem Buchstaben "M"



Hard Metal SuperCut Scissors

- blades with welded hard metal
- lower blade with razor-sharp cutting edge and microfine serrated upper blade (MC)

Identifying features:

- + long gold plated rings
- + the article number ends with the letter "M"



Schere mit Keramikbeschichtung

- Keramikbeschichtung

Erkennungsmerkmale:

- + schwarze Keramikbeschichtung
- + vergoldete Schraube
- + die Artikelnummer endet mit dem Buchstaben "C"



Scissors with Ceramic Coating

- ceramic coating

Identifying features:

- + black ceramic coating
- + gold plated screw
- + the article number ends with the letter "C"





SuperCut-Schere mit Keramikbeschichtung

- unteres Blatt mit rasiermesserscharfer Schneide und oberes Blatt mikrofein gezahnt (MC)
- Keramikbeschichtung (CC)

Erkennungsmerkmale:

- + schwarze Keramikbeschichtung
- + vergoldete Schraube
- + die Artikelnummer endet mit dem Buchstaben "N"



SuperCut Scissors with Ceramic Coating

- lower blade with razor-sharp cutting edge and microfine serrated upper blade (MC)
- ceramic coating (CC)

Identifying features:

- + black ceramic coating,
- + gold plated screw
- + the article number ends with the letter "N"



Hartmetallschere mit Keramikbeschichtung

- Schneiden mit aufgeschweißtem Hartmetall
- Keramikbeschichtung (CC)

Erkennungsmerkmale:

- + schwarze Keramikbeschichtung
- + vergoldete Ringe
- + vergoldete Schraube
- + die Artikelnummer endet mit dem Buchstaben "C"



Hard Metal Scissors with Ceramic Coating

- blades with welded hard metal
- ceramic coating (CC)

Identifying features:

- + black ceramic coating
- + gold plated rings
- + gold plated screw and
- + the article number ends with the letter "C"





Hartmetall-SuperCut-Scheren mit Keramikbeschichtung

- Schneiden mit aufgeschweißtem Hartmetall
- unteres Blatt mit rasiermesserscharfer Schneide und oberes Blatt mikrofein gezahnt (MC)
- Keramikbeschichtung (CC)

Erkennungsmerkmale:

- + schwarze Keramikbeschichtung,
- + lang vergoldete Ringe
- + vergoldete Schraube
- + die Artikelnummer endet mit dem Buchstaben "N"



Hard Metal SuperCut Scissors with Ceramic Coating

- blades with welded hard metal
- lower blade with razor-sharp cutting edge and microfine serrated upper blade (MC)
- ceramic coating (CC)

Identifying features:

- + black ceramic coating
- + long gold plated rings
- + gold plated screw
- + the article number ends with the letter "N"



MASTERCUT

- RUDOLF Schliff - unteres Blatt mit speziell eingesetzter und rasiermesserscharfer Schneide, oberes Blatt mikrofein gezahnt
- schwarzbeschichtete Schraube
- Oberfläche mit spezieller Hartbeschichtung
- besonders feines Finish und sehr weicher Gang

Erkennungsmerkmale:

- + grüne Oberflächenbeschichtung
- + schwarzbeschichtete Schraube
- + DataMatrix Code
- + RUDOLF Signet
- + MASTERCUT Logo auf dem unteren Scherenblatt
- + die Artikelnummer endet mit dem Buchstaben „G“

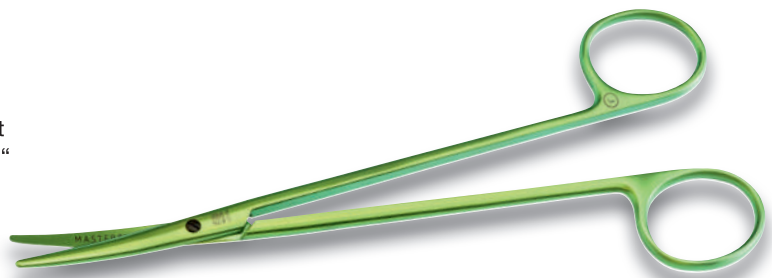

MASTERCUT

- RUDOLF Sharpening – lower blade with special tapered and razor-sharp cutting edge, upper blade with microfine serration
- black coated screw
- surface with special hard coating
- extremely fine finish and very smooth movement

Identifying features:

- + green surface coating
- + black coated screw
- + DataMatrix Code
- + RUDOLF signet
- + MASTERCUT logo on the lower cutting blade
- + the article number ends with the letter "G"



Standard-Schere

- hergestellt aus hochwertigem Edelstahl
- mit hochglanzpolierter Oberfläche



Standard Scissors

- *manufactured of high grade stainless steel*
- *high polished surface*



RUDOLF Supreme-Line

- hergestellt aus hochwertigem Edelstahl
- besonderes feines Finish in der Schneide und extrem weicher Gang

Erkennungsmerkmale:

- + hochglanzpolierte Arbeitsenden
- + die Artikelnummer endet mit dem Buchstaben "S"



RUDOLF Supreme-Line

- *manufactured of high grade stainless steel*
- *extremely fine finish of the cutting edges and very smooth movement*

Identifying features:

- + *highly polished working ends*
- + *the article number ends with the letter "S"*



Hartmetallschere mit Wellenschliff

- Schneiden mit aufgeschweißtem Hartmetall
- unteres Blatt mit feinem Wellenschliff (W)

Erkennungsmerkmale:

- + vergoldete Ringe und
- + die Artikelnummer endet mit dem Buchstaben "W"



Hard Metal Scissors with Wavecut

- *blades with welded hard metal*
- *lower blade with fine wavecut (W)*

Identifying features:

- + *gold plated rings*
- + *the article number ends with the letter "W"*







Sehnenschere
Tenotomy scissors

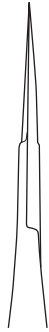

spitz / spitz
gerade
*sharp / sharp
straight*

11,5 cm – 4½"

RU 2240-11

1:1
WESTCOTT



Sehnenschere
Tenotomy scissors

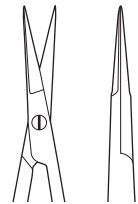

spitz / spitz
gerade
*sharp / sharp
straight*

9,5 cm – 3¾"

RU 2244-09

1:1



1:1
VANNAS



spitz / spitz
gerade
*sharp / sharp
straight*



spitz / spitz
gebogen
*sharp / sharp
curved*

8,5 cm – 3¼"

RU 2260-08

RU 2261-08



Hornhautschere
Corneal scissors



links
left

10 cm – 4"

RU 2338-10



Hornhautschere
Corneal scissors



rechts
right

10 cm – 4"

RU 2339-10



Venenschere

- kein Abgleiten des Gefäßes
- glatte, saubere Durchtrennung

Vein scissors

- vessel cannot slip off
- clean, smooth cut



13 cm – 5"

RU 2370-01

1:1
BIEMER



Mikro-Federscheren Micro Spring Scissors



Sehnenschere
Tenotomy scissors

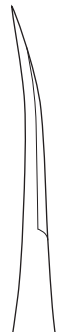

spitz / spitz
gebogen
*sharp / sharp
curved*

11 cm – 4¼"

RU 2330-11

1:1
WESTCOTT



Sehnenschere
Tenotomy scissors



stumpf / stumpf
gebogen
*blunt / blunt
curved*

11 cm – 4¼"

RU 2335-11

1:1
WESTCOTT



Sehnenschere für Linkshänder
Tenotomy scissors for left-hander



stumpf / stumpf
gebogen
*blunt / blunt
curved*

11 cm – 4¼"

RU 2336-11

1:1
WESTCOTT



gerade
straight



gebogen
curved

20 cm – 8"	RU 2252-42	RU 2252-43
22,5 cm – 9"	RU 2253-52	RU 2253-53
24,5 cm – 9¾"	RU 2253-62	RU 2253-63



gerade
straight



gebogen
curved

19 cm – 7½"

RU 2360-19	RU 2361-19
-------------------	-------------------





Feine Scheren Delicate Scissors



Augenschere
Eye scissors



KNAPP

			
stumpf / stumpf blunt / blunt	spitz / spitz sharp / sharp	stumpf / stumpf blunt / blunt	spitz / spitz sharp / sharp
gerade straight		gebogen curved	
10,5 cm – 4¼"		10,5 cm – 4¼"	
RU 2404-01	RU 2404-03	RU 2405-01	RU 2405-03



Iris- und Fadenschere
Iris and suture scissors



				
	gerade straight	gebogen curved	gerade straight	gebogen curved
			FINO	
9,5 cm – 3¾"	RU 2420-09	RU 2421-09	RU 2422-09	RU 2423-09
10,5 cm – 4¼"	RU 2420-10	RU 2421-10	RU 2422-10	RU 2423-10
11,5 cm – 4½"	RU 2420-11	RU 2421-11	RU 2422-11	RU 2423-11



große Ringe
large rings

	
gerade straight	gebogen curved
10 cm – 4"	
RU 2426-10	RU 2427-10

Irisschere mit flachen Branchen
Iris scissors »Ribbon Type«



spitz / spitz
gebogen
*sharp / sharp
curved*

9,5 cm – 3¾"

RU 2476-03

Irisschere mit flachen Branchen
Iris scissors »Ribbon Type«



stumpf / stumpf
gerade
*blunt / blunt
straight*

9,5 cm – 3¾"

RU 2477-02



stumpf / stumpf
gebogen
*blunt / blunt
curved*

RU 2477-03

Irisschere mit flachen Branchen
Iris scissors »Ribbon Type«



spitz / spitz
gerade
*sharp / sharp
straight*

9,5 cm – 3¾"

RU 2478-02



gerade
straight

11 cm – 4¼"

RU 2480-11



stumpf / stumpf
gebogen
*blunt / blunt
curved*

11,5 cm – 4½"

RU 2518-11

Feine Scheren Delicate Scissors



Strabismus Scheren
Strabismus scissors



stumpf / stumpf
gebogen
blunt / blunt
curved

11,5 cm – 4½"

RU 2572-11



spitz / spitz
gerade
sharp / sharp
straight

11 cm – 4¼"

RU 2598-11



gerade
straight



gebogen
curved

Typ / Type

9 cm – 3½"

	RU 1630-09	RU 1631-09
MC	RU 1630-09M	RU 1631-09M
TC	RU 2406-09	RU 2407-09
TC/MC	RU 2406-09M	RU 2407-09M
TC/MC/CC	RU 2406-09N	RU 2407-09N



gerade
straight



gebogen
curved



extra flach
extra flat

10,5 cm – 4¼"

RU 1630-10 **RU 1631-10** **RU 1632-10**

Feine Scheren Delicate Scissors







 gerade
straight



 gebogen
curved

10,5 cm – 4¼"

RU 2418-10	RU 2419-10
-------------------	-------------------



 gerade
straight

 gebogen
curved

11,5 cm – 4½"

RU 2418-11	RU 2419-11
-------------------	-------------------

FINO







stumpf / stumpf
blunt / blunt

gebogen
curved

11,5 cm – 4½"

RU 2397-01





MC
SuperCut

CC
Ceramic Coating

TC
Hard Metal

 gerade
straight

 gebogen
curved

 sichelförmig
sickle shaped

11,5 cm – 4½"

Typ / Type	RU 1630-11	RU 1631-11	RU 2416-11
MC	RU 1630-11M	RU 1631-11M	–
TC	RU 2406-11	RU 2407-11	–
TC/MC	RU 2406-11M	RU 2407-11M	–
TC/MC/CC	RU 2406-11N	RU 2407-11N	–



gewinkelt
angled

9 cm – 3½"

RU 1636-09



gebogen
curved

10 cm – 4"

RU 1638-10

WALTON



gerade
straight

14,5 cm – 5¾"

RU 1640-14

SANVENERO



gebogen
curved

14,5 cm – 5¾"

RU 1641-14

SANVENERO

Feine chirurgische Scheren Delicate Surgical Scissors



stumpf / stumpf
blunt / blunt

gerade
straight

gebogen
curved

12 cm – 4¾"	RU 1501-12	RU 1511-12
-------------	-------------------	-------------------



spitz / spitz
sharp / sharp

Typ
Type

gerade
straight

gebogen
curved

12 cm – 4¾"		RU 1503-12	RU 1513-12
	HP	RU 1503-12HP	RU 1513-12HP
	MC	RU 1503-12M	RU 1513-12M



gerade
straight

gebogen
curved

11,5 cm – 4½"	MC	RU 1518-11M	RU 1519-11M
---------------	-----------	--------------------	--------------------



WAGNER

			
		spitz / spitz sharp / sharp	
Typ Type		gerade straight	gebogen curved
12 cm – 4¾"		RU 1523-12	RU 1526-12
	MC	RU 1523-12M	RU 1526-12M



WAGNER



stumpf / stumpf
gerade
blunt / blunt
straight

12 cm – 4¾"

RU 1521-12



BROPHY (SULLIVAN)



spitz / spitz
gerade
sharp / sharp
straight

14,5 cm – 5¾"

RU 1550-14

Chirurgische Scheren Surgical Scissors



stumpf / stumpf
blunt / blunt
gerade / straight



stumpf / stumpf
blunt / blunt
gebogen / curved

TC Hard Metal	Typ Type	gerade straight	gebogen curved
10,5 cm – 4¼"		RU 1001-10	–
11,5 cm – 4½"		RU 1001-11	RU 1011-11
13 cm – 5"		RU 1001-13	RU 1011-13
14,5 cm – 5¾"		RU 1001-14	RU 1011-14
	TC	RU 1004-14	RU 1014-14
15,5 cm – 6"		RU 1001-15	RU 1011-15
16,5 cm – 6½"		RU 1001-16	RU 1011-16
17,5 cm – 7"		RU 1001-17	–
18,5 cm – 7¼"		RU 1001-18	RU 1011-18
20 cm – 8"		RU 1001-20	RU 1011-20



spitz / stumpf
sharp / blunt
gerade / straight



spitz / stumpf
sharp / blunt
gebogen / curved



TC Hard Metal	Typ Type	gerade straight	gebogen curved
10,5 cm – 4¼"		RU 1002-10	–
11,5 cm – 4½"		RU 1002-11	RU 1012-11
13 cm – 5"		RU 1002-13	RU 1012-13
14,5 cm – 5¾"		RU 1002-14	RU 1012-14
	HP	RU 1002-14HP	–
	MC	RU 1002-14M	RU 1012-14M
	TC	RU 1006-14	RU 1016-14
15,5 cm – 6"		RU 1002-15	RU 1012-15
16,5 cm – 6½"		RU 1002-16	RU 1012-16
18,5 cm – 7¼"		RU 1002-18	RU 1012-18

Chirurgische Scheren Surgical Scissors



spitz / spitz
sharp / sharp
gerade / straight



spitz / spitz
sharp / sharp
gebogen / curved

TC Hard Metal	Typ Type	gerade straight	gebogen curved
	10,5 cm – 4¼"		RU 1003-10
11,5 cm – 4½"		RU 1003-11	RU 1013-11
13 cm – 5"		RU 1003-13	RU 1013-13
14,5 cm – 5¾"		RU 1003-14	RU 1013-14
	TC	RU 1008-14	RU 1018-14
15,5 cm – 6"		RU 1003-15	–
16,5 cm – 6½"		RU 1003-16	RU 1013-16
17,5 cm – 7"		–	–
18,5 cm – 7¼"		RU 1003-18	–
20 cm – 8"		RU 1003-20	–



schlankes Modell
slender pattern



stumpf / stumpf
blunt / blunt



spitz / stumpf
sharp / blunt



spitz / spitz
sharp / sharp

	gerade straight	gebogen curved	gerade straight	gebogen curved	gerade straight	gebogen curved
14,5 cm – 5¾"	RU 1021-14	RU 1031-14	RU 1022-14	RU 1032-14	RU 1023-14	RU 1033-14

GRAZIL

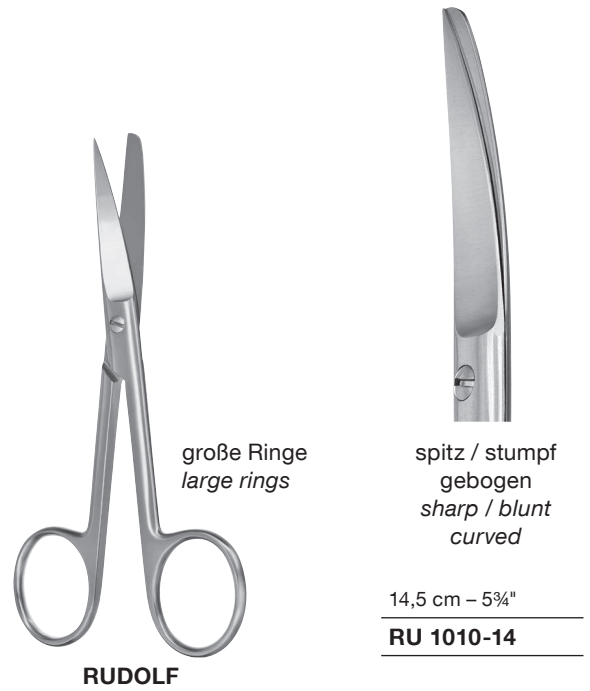
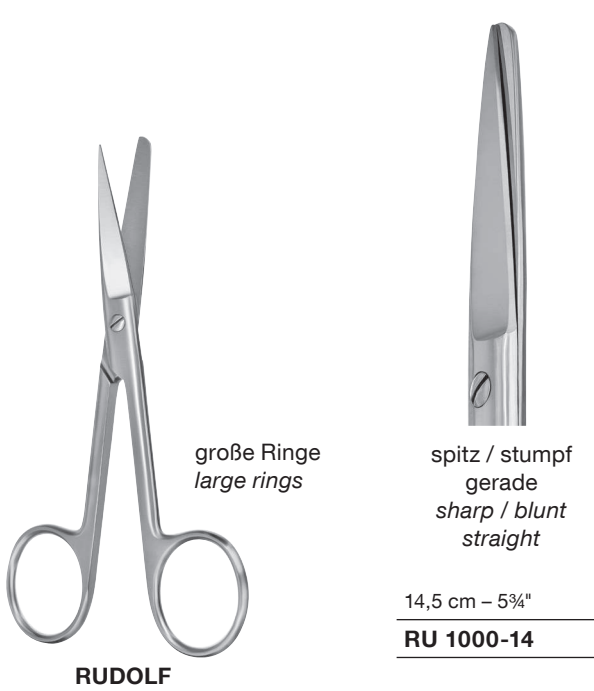



NEW SUTURE



Typ / Type

14,5 cm – 5¾"

RU 1132-14

HP

RU 1132-14HP



spitz / spitz
gebogen
*sharp / sharp
curved*

Inzisionsschere
Incision scissors



gerade
straight

13 cm – 5"

RU 1110-13

Feine Präparierscheren Delicate Dissecting Scissors



Sehnenscherer
Tenotomy scissors



STEVENS



gerade
straight



gebogen
curved



gerade
straight



gebogen
curved

Typ Type	spitz sharp		stumpf blunt	
	RU 2430-10	RU 2431-10	RU 2440-10	RU 2441-10
10,5 cm – 4¼"	MC	–	RU 2440-10M	RU 2441-10M
11,5 cm – 4½"	HP	–	RU 2440-11HP	RU 2441-11HP
	MC	RU 2430-11M	RU 2440-11M	RU 2441-11M

Sehnenscherer
Tenotomy scissors



KLEINERT-KUTZ



stumpf / stumpf
gebogen
blunt / blunt
curved

12,5 cm – 5"

RU 2433-12

Sehnenscherer
Tenotomy scissors



STEVENS- RUDOLF



stumpf
leicht gebogen
blunt
slightly curved



Typ / Type

9,5 cm – 3¾"

MC

RU 2441-09M

Feine Präparierscheren Delicate Dissecting Scissors



**MODELL BONN
BONN PATTERN**



Typ / Type

HP



gerade
straight



gebogen
curved

8 cm – 3¼"

	RU 2450-08	RU 2451-08
HP	RU 2450-08HP	RU 2451-08HP



GRAEFE



gewinkelt
angled

10,5 cm – 4¼"

RU 2455-10



WILMER



Typ / Type

TC



gewinkelt
angled

10 cm – 4"

11,5 cm – 4½"

	RU 2457-10	–
TC	–	RU 2458-10

Strabismusschere
Strabismus scissors



Typ / Type

TC

TC/MC

TC/MC/CC



gerade
straight



gebogen
curved

11,5 cm – 4½"

	RU 2460-11	RU 2461-11
TC	RU 2462-11	RU 2463-11
TC/MC	–	RU 2463-11M
TC/MC/CC	–	RU 2463-11N

Feine Präparierscheren Delicate Dissecting Scissors



Zahnfleissschere
Gum scissors



GOLDMANN-FOX



gerade
straight



gebogen
curved

oberes Blatt
mikrofein gezahnt
microfine serrated
upper blade

Typ / Type

13 cm – 5"

	RU 2900-13	RU 2901-13
TC	–	RU 2903-13
MC	–	RU 2901-13M



REYNOLDS



gerade
straight



gebogen
curved



gebogen
curved

Typ / Type

15,5 cm – 6"

	RU 1580-15	RU 1581-15	RU 1581-18
MC	RU 1580-15M	RU 1582-15M	RU 1581-18M



JAMESON

MC
SuperCut



gebogen
curved



gebogen
curved

Typ / Type	14,5 cm – 5¾"	18 cm – 7"
	RU 1583-15	–
MC	RU 1583-15M	RU 1583-18M



JAMESON-WERBER



gebogen
curved



gebogen
curved

Typ / Type	13 cm – 5"	15 cm – 6"
	RU 1584-13	RU 1584-15



LEXER



gerade
straight



gebogen
curved

Typ / Type

16 cm – 6¼"

	RU 1100-16	RU 1101-16
TC	RU 1102-16	RU 1103-16



LEXER-FINO



gerade
straight



gebogen
curved

Typ / Type

16 cm – 6¼"

	RU 1104-16	RU 1105-16
TC	–	RU 1107-16



MAYO



	gerade straight	gerade straight	gerade straight
Typ / Type	14,5 cm – 5¾"	15 cm – 6"	17 cm – 6¾"
	RU 1250-14	RU 1250-15	RU 1250-17
S	RU 1250-14S	–	–
MC	RU 1250-14M	–	RU 1250-17M
TC	RU 1252-14	–	RU 1252-17
TC/MC	RU 1252-14M	–	RU 1252-17M



MAYO



	gerade straight	gerade straight
Typ / Type	20 cm – 8"	23 cm – 9"
	RU 1250-20	RU 1250-23
HP	RU 1250-20HP	RU 1250-23HP
MC	–	RU 1250-23M
TC	–	RU 1252-23



MAYO



gebogen
curved



gebogen
curved



gebogen
curved

Typ / Type	14 cm – 5½"	15 cm – 6"	17 cm – 6¾"
	RU 1251-14	RU 1251-15	RU 1251-17
S	RU 1251-14S	–	–
MC	RU 1251-14M	–	RU 1251-17M
TC	RU 1253-14	–	RU 1253-17
TC/MC	–	–	RU 1253-17M

MASTERCUT



MAYO



gebogen
curved



14 cm – 5½"	RU 1251-14G
17 cm – 6¾"	RU 1251-17G

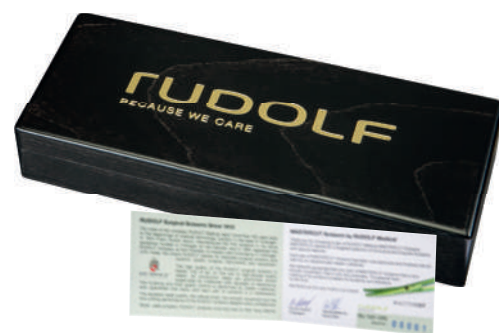

Jede MasterCut-Schere wird mit individuellem Zertifikat und in einer edlen Holzbox geliefert.

Each pair of MasterCut scissors comes with an individual certificate and in an exclusive wooden box.



MasterCut Video

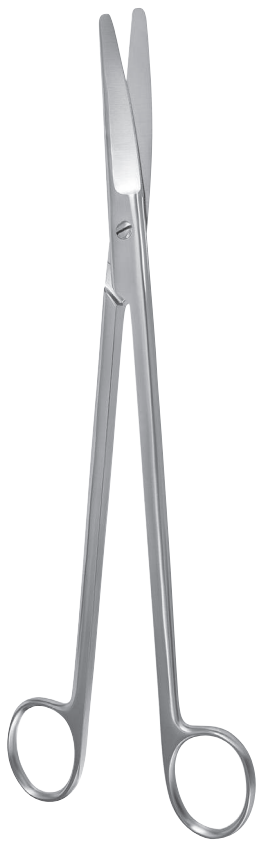

MAYO



gebogen
curved

gebogen
curved

gebogen
curved

Typ / Type	20 cm – 8"	23 cm – 9"	28 cm – 11"
	RU 1251-20	RU 1251-23	RU 1251-28
HP	RU 1251-20HP	RU 1251-23HP	RU 1251-28HP
MC	–	RU 1251-23M	–
TC	–	RU 1253-23	–



MAYO-STILLE



gerade
straight

gerade
straight

Typ / Type	14,5 cm – 5¾"	17 cm – 6¾"
	RU 1260-15	RU 1260-17
HP	RU 1260-15HP	RU 1260-17HP
MC	RU 1260-15M	RU 1260-17M
TC	RU 1262-15	RU 1262-17
TC/MC	–	RU 1262-17M



MAYO-STILLE



gebogen
curved

Typ / Type	14,5 cm – 5¾"	17 cm – 6¾"	19 cm – 7½"	21 cm – 8¼"
	RU 1261-15	RU 1261-17	RU 1261-19	RU 1261-21
HP	–	RU 1261-17HP	–	–
MC	RU 1261-15M	RU 1261-17M	–	–
TC	RU 1263-15	RU 1263-17	–	–
TC/MC	–	RU 1263-17M	–	–



MAYO-NOBLE



gerade
straight

gebogen
curved

Typ / Type	17 cm – 6¾"	
	RU 1270-17	RU 1271-17
HP	RU 1270-17HP	–



BABY-METZENBAUM



gerade
straight



gebogen
curved



gerade
straight



gebogen
curved

Typ / Type

9 cm – 3½"

11,5 cm – 4½"

	9 cm – 3½"		11,5 cm – 4½"	
	–	–	RU 1280-11	RU 1281-11
S	–	–	–	RU 1281-11S
MC	–	–	RU 1280-11M	RU 1281-11M
TC	RU 1280-49	RU 1281-49	RU 1280-51	RU 1281-51



METZENBAUM-FINO



stumpf / stumpf
blunt / blunt



gebogen
curved



spitz / spitz
sharp / sharp

gebogen
curved

Typ / Type

14,5 cm – 5¾"

	RU 1290-14	RU 1291-14	RU 1293-14
MC	RU 1290-14M	RU 1291-14M	–
TC	RU 1306-14	RU 1316-14	RU 1318-14
TC/MC	–	RU 1316-14M	–



METZENBAUM



stumpf / stumpf
blunt / blunt

Typ / Type	13 cm – 5"		14,5 cm – 5¾"	
	gebogen curved	gerade straight	gebogen curved	gebogen curved
	RU 1311-13	RU 1301-14	RU 1311-14	
S	–	–	RU 1311-14S	
MC	–	RU 1301-14M	RU 1311-14M	
TC	–	RU 1304-14	RU 1314-14	
TC/MC	–	–	RU 1314-14M	
TC/CC	–	–	RU 1314-14C	
TC/MC/CC	–	–	RU 1314-14N	

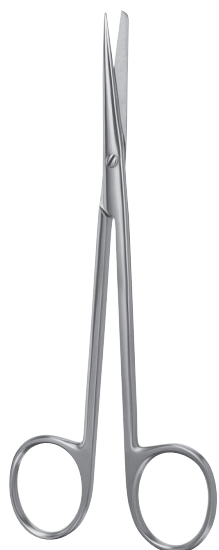

METZENBAUM



spitz / stumpf
sharp / blunt

spitz / spitz
sharp / sharp

Typ / Type	14,5 cm – 5¾"			
	gerade straight	gebogen curved	gerade straight	gebogen curved
	RU 1302-14	RU 1312-14	RU 1303-14	RU 1313-14
TC	–	–	RU 1308-14	–

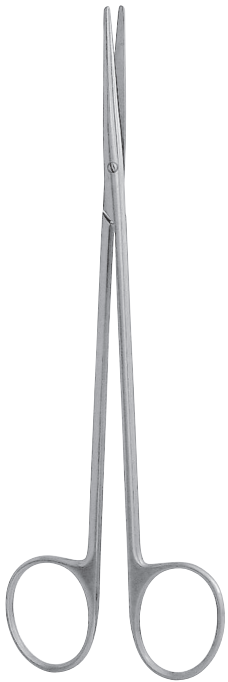

METZENBAUM-FINO



gerade
straight



gebogen
curved



gerade
straight



gebogen
curved

Typ / Type	18 cm – 7"		20 cm – 8"	
	RU 1320-18	RU 1330-18	RU 1320-20	RU 1330-20
MC	–	RU 1330-18M	–	–
TC	RU 1326-18	RU 1336-18	–	RU 1336-20
TC/MC	–	RU 1336-18M	–	–

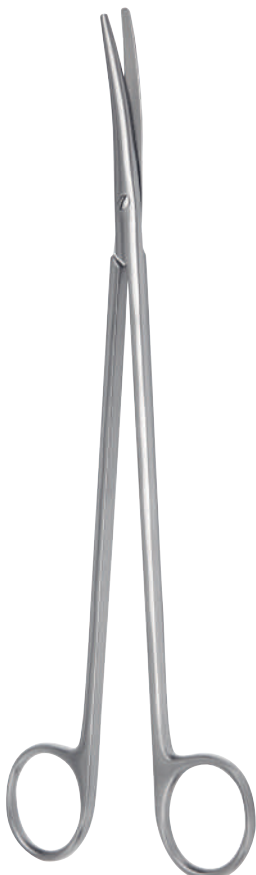

METZENBAUM-FINO



gerade
straight



gebogen
curved



gebogen
curved



gebogen
curved

Typ / Type	23 cm – 9"		25 cm – 10"	28 cm – 11"
	–	RU 1330-23	RU 1330-25	RU 1330-28
MC	–	RU 1330-23M	–	–
TC	RU 1326-23	RU 1336-23	RU 1336-25	RU 1336-28
TC/MC	–	RU 1336-23M	–	–



METZENBAUM



gerade
straight

gebogen
curved

gerade
straight

gebogen
curved

Typ / Type	18 cm – 7"		20 cm – 8"	
	RU 1321-18	RU 1331-18	RU 1321-20	RU 1331-20
MC	RU 1321-18M	RU 1331-18M	–	RU 1331-20M
CC	–	RU 1331-18C	–	–
MC/CC	–	RU 1331-18N	–	–
TC	RU 1324-18	RU 1334-18	RU 1324-20	RU 1334-20
TC/MC	–	RU 1334-18M	–	RU 1334-20M
TC/MC/CC	–	RU 1334-18N	–	–
TC/CC	–	RU 1334-18C	–	RU 1334-20C
TC/W	–	RU 1334-18W	–	–

MASTERCUT



METZENBAUM



gebogen
curved



14,5 cm – 5¾"	RU 1311-14G
18 cm – 7"	RU 1331-18G
20 cm – 8"	RU 1331-20G

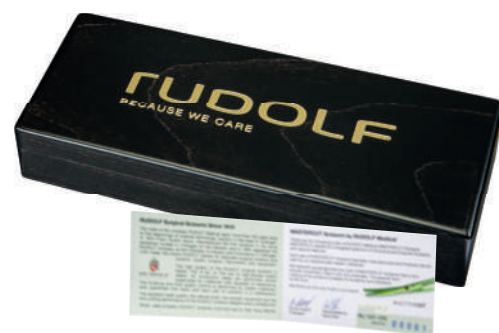

Jede MasterCut-Schere wird mit individuellem Zertifikat und in einer edlen Holzbox geliefert.

Each pair of MasterCut scissors comes with an individual certificate and in an exclusive wooden box.



MasterCut Video



METZENBAUM



Typ / Type	18 cm – 7"
S	RU 1331-18S



gebogen
curved



METZENBAUM



spitz / spitz
sharp / sharp

gebogen
curved

18 cm – 7"	RU 1333-18
20 cm – 8"	RU 1333-20

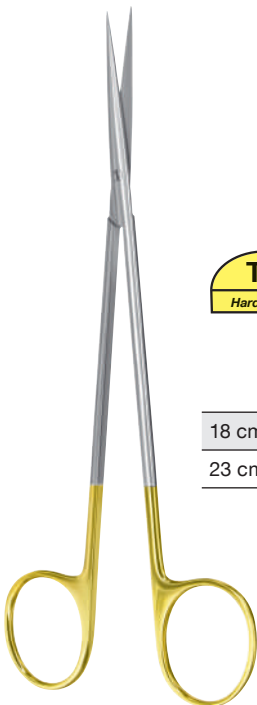

METZENBAUM



	Typ Type	gerade straight	gebogen curved
18 cm – 7"	TC	RU 1328-18	RU 1338-18
23 cm – 9"	TC	RU 1328-23	RU 1338-23



spitz / spitz
sharp / sharp



METZENBAUM-S



S-gebogen
S-curved



Typ Type	18 cm – 7"
TC	RU 1339-18



METZENBAUM



gerade
straight

gebogen
curved

gerade
straight

gebogen
curved

Typ / Type	23 cm – 9"		25 cm – 10"	
	RU 1321-23	RU 1331-23	RU 1321-25	RU 1331-25
MC	–	RU 1331-23M	–	RU 1331-25M
CC	–	–	–	–
TC	RU 1324-23	RU 1334-23	–	RU 1334-25
TC/MC	–	RU 1334-23M	–	–



gebogen
curved

gebogen
curved



Typ / Type	28 cm – 11"	30 cm – 11¾"
	RU 1331-28	RU 1331-30
MC	RU 1331-28M	–
TC	RU 1334-28	RU 1334-30

Facelift- und Nasenscheren Facelift and Nasal Scissors



HP
High polished



gerade
straight



gebogen
curved

Typ / Type	10 cm – 4"	
	RU 1650-10	RU 1651-10
HP	RU 1650-10HP	-

BABY-LEXER (KNAPP)



gerade
straight



gebogen
curved

13 cm – 5"

RU 1654-13	RU 1655-13
-------------------	-------------------

Blepharoplastik Schere
Blepharoplasty scissors



TC
Hard Metal

W
Wavecut



gebogen
curved

Typ / Type	11,5 cm – 4½"
TC/W	RU 1659-61W



MC
SuperCut

TC
Hard Metal

W
Wavecut



gebogen
curved

Typ / Type	11,5 cm – 4½"
MC	RU 1661-11M
TC/W	RU 1661-61W

KAYE



JOSEPH



gerade
straight



gebogen
curved

Typ / Type	14 cm – 5½"	
	RU 1670-14	RU 1671-14
MC	RU 1670-14M	RU 1671-14M
HP	RU 1670-14HP	RU 1671-14HP



KILNER

Schwedisches Modell
Swedish pattern



gebogen
curved

Typ / Type	12,5 cm – 5"
MC	RU 1674-12M
HP	RU 1674-12HP



KILNER



gebogen
curved

Typ / Type	12,5 cm – 5"	13,5 cm – 5¼"	15,5 cm – 6"
	RU 1675-12	RU 1675-13	RU 1675-15
MC	RU 1675-12M	–	–



RUDOLF



Typ / Type

MC



stumpf / stumpf
blunt / blunt

gebogen
curved

11 cm – 4¼"

RU 1676-11M



RUDOLF



Typ / Type

MC



stumpf / stumpf
blunt / blunt

gebogen
curved

14,5 cm – 5¾"

RU 1676-14M



REYNOLDS



Typ / Type

MC



gebogen
curved

13 cm – 5"

RU 1677-13M

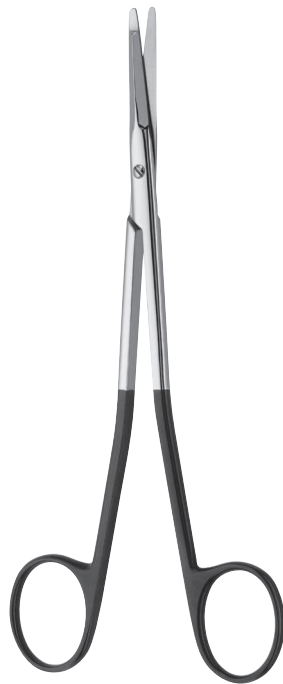

FREEMAN-KAYE



gerade
straight



gebogen
curved

Typ / Type

18 cm – 7"

MC	RU 1680-18M	RU 1681-18M
-----------	--------------------	--------------------

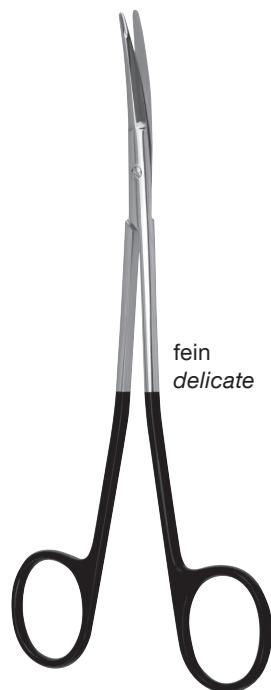

FREEMAN-KAYE

fein
delicate



gebogen
curved

Typ / Type

18 cm – 7"

MC	RU 1681-28M
TC/MC/CC	RU 1681-78N



FREEMAN-GORNEY



gerade
straight



gebogen
curved

Typ / Type

19 cm – 7½"

MC

RU 1682-19M

RU 1683-19M



KAYE



gebogen
curved



Typ / Type

15 cm – 6"

19 cm – 7½"

MC

RU 1685-15M

RU 1685-19M

HP

–

RU 1685-19HP



CASTANARES



gerade
straight

Typ / Type	16 cm – 6¼"
MC	RU 1687-16M



GORNEY



gerade
straight



gebogen
curved

Typ / Type	18,5 cm – 7¼"	
MC	RU 1688-19M	RU 1689-19M



fein
delicate



GORNEY



gerade
straight



gebogen
curved

Typ / Type

19 cm – 7½"

MC	RU 1688-29M	RU 1689-29M
TC/MC/CC	RU 1688-79N	RU 1689-79N

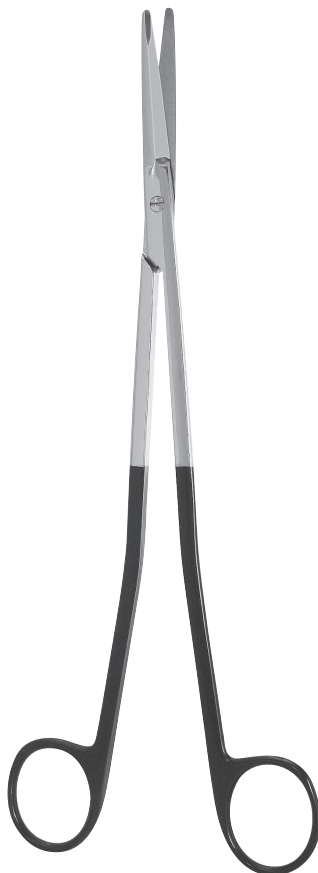

GORNEY



gerade
straight

Typ / Type

23 cm – 9"

MC	RU 1690-23M
-----------	--------------------



FREEMAN



gebogen
curved

Typ / Type	18 cm – 7"
MC	RU 1693-18M

Präparier- und Ligaturscheren Dissecting- and Ligature Scissors



Speziell zum Schneiden von Nahtmaterial:

- Schneiden mit aufgeschweißtem Hartmetall für erhöhte Standzeit
- fein gezahntes Blatt verhindert ein Herausrutschen des Nahtmaterials
- weit auslaufender Schluss verhindert ein Einklemmen oder Verfangen des Nahtmaterials
- weit ausgestellte Griffbranchen für optimierte Handhabung

Especially for the cutting of suture material:

- blades with welded hard metal for extended lifetime
- fine serrated blade prevents the slipping of suture material
- smoothly widening lock design prevents the suture material from getting caught in the parts of the scissors
- flared shanks for optimized handling



gebogen
curved

Typ / Type	14,5 cm – 5¾"	18 cm – 7"	23 cm – 9"
TC	RU 1314-14RS	RU 1334-18RS	RU 1334-23RS

Bipolare Scheren

Bipolar Scissors



Allgemein

Merkmale unserer bipolaren Scheren:

- RUDOLF Bipolare Scheren ermöglichen das Schneiden und Präparieren bei gleichzeitiger bipolarer Koagulation.
- Präzises punkt- oder flächenförmiges Koagulieren von Gefäßen und Gewebeflächen möglich.
- Besonders anwenderfreundlich, da das Anschlusskabel nur an einem Ring befestigt wird.

General information

Features of our bipolar scissors:

- RUDOLF bipolar scissors enable cutting and dissection with simultaneous bipolar coagulation.
- Precise pinpoint or zone coagulation of blood vessels and tissue possible.
- Very user-friendly, because the connection cable is attached only to one ring.

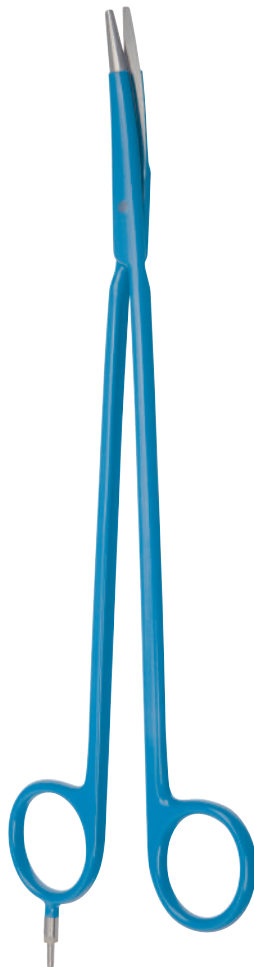

METZENBAUM



Länge Length	gebogen schlank curved slim
18 cm – 7"	RU 1382-18
23 cm – 9"	RU 1382-23

Bipolare Anschlusskabel für die abgebildeten Scheren finden Sie im Katalog GENERAL SURGERY (ZK 300) auf Seite HF 6.

Bipolar connection cables for the illustrated scissors can be found in the GENERAL SURGERY (ZK 300) catalog on page HF 6.

Nasenscheren Nasal Scissors

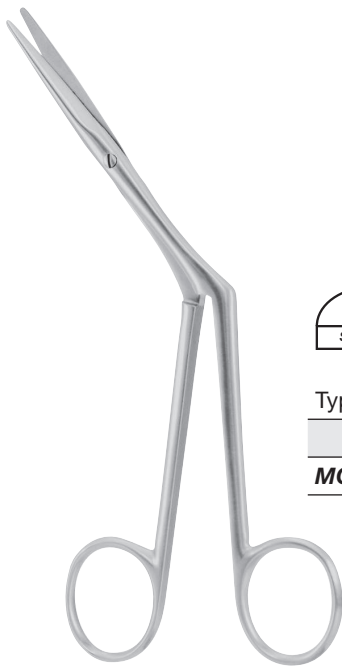

HEYMANN



seitlich gewinkelt
angled sideways

Typ / Type	18 cm – 7"
	RU 2115-18
MC	RU 2115-18M

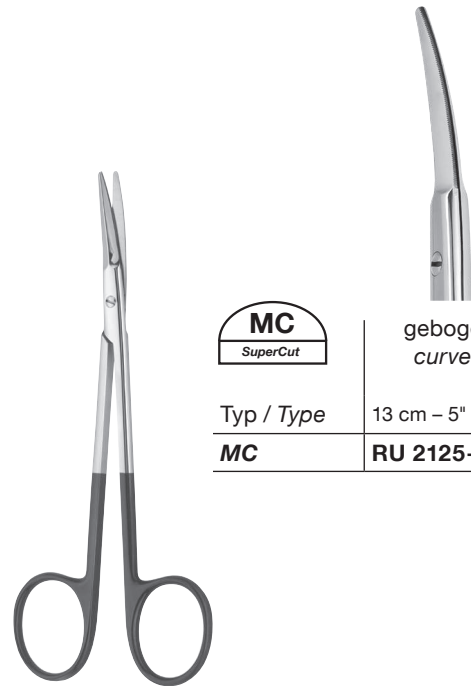

FOMON-SABER-BACK



gebogen
curved

Typ / Type	13 cm – 5"
MC	RU 2125-13M



FOMON



abgewinkelt
angled down

Typ / Type	13 cm – 5"
TC	RU 2129-13



FOMON



abgewinkelt
angled down

Typ / Type	13 cm – 5"
TC	RU 2130-13



schlankes Modell
slender pattern



abgewinkelt
angled down

Typ / Type	13,5 cm – 5¼"
MC	RU 2131-13M

FOMON

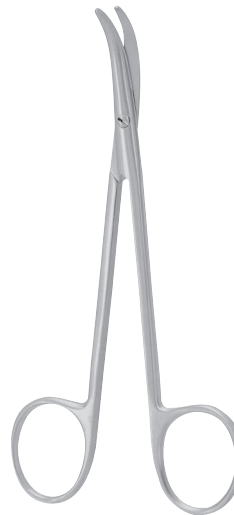

gebogen
curved

Typ / Type	13,5 cm – 5¼"
MC	RU 2132-13M

FOMON



COTTLE



abgewinkelt
angled down

Typ / Type	16 cm – 6¼"
TC	RU 2136-16
MC	RU 2135-16M



Gefäßschere
mit Knopf
Vascular scissors
probe-pointed



gerade
straight

11,5 cm – 4½"

RU 1705-11

Endarterektomie-Schere
Endarterectomy scissors



stumpf / stumpf
gebogen
blunt / blunt
curved

Typ / Type

17 cm – 6¾"

MC

RU 1718-17M



gerade
straight

19 cm – 7½"

RU 1730-19

1:3

MC INDOE



POTTS-SMITH

MC
SuperCut



gewinkelt
angled

Typ / Type	18,5 cm – 7¼"		18 cm – 7"
	RU 1720-19	RU 1721-19	RU 1722-19
MC	RU 1720-19M	RU 1721-19M	RU 1722-19M



DE BAKEY

HP
High polished



gewinkelt
angled

Typ / Type	17 cm – 6¾"	16 cm – 6¼"
	RU 1750-16	RU 1754-16
HP	–	RU 1754-16HP



gewinkelt
angled

HEGEMANN-DIETRICH

		25°		45°	
		Typ / Type 13,5 cm – 5¼"			
		-		RU 1761-13	
		Typ / Type 15,5 cm – 6"			
		-		RU 1761-16	
		Typ / Type 18 cm – 7"			
		RU 1760-19		RU 1761-19	
MC		RU 1760-19M		RU 1761-19M	

		60°		90°		125°	
		Typ / Type 17,5 cm – 7"		17 cm – 6¾"			
		RU 1762-19		RU 1763-19		RU 1764-19	
MC		RU 1762-19M		RU 1763-19M		RU 1764-19M	



mit Führungsschiene
with stabilising bar

HEGEMANN-DIETRICH

		125° gewinkelt angled	
		Typ / Type 17 cm – 6¾"	
		RU 1765-19	
MC		RU 1765-19M	

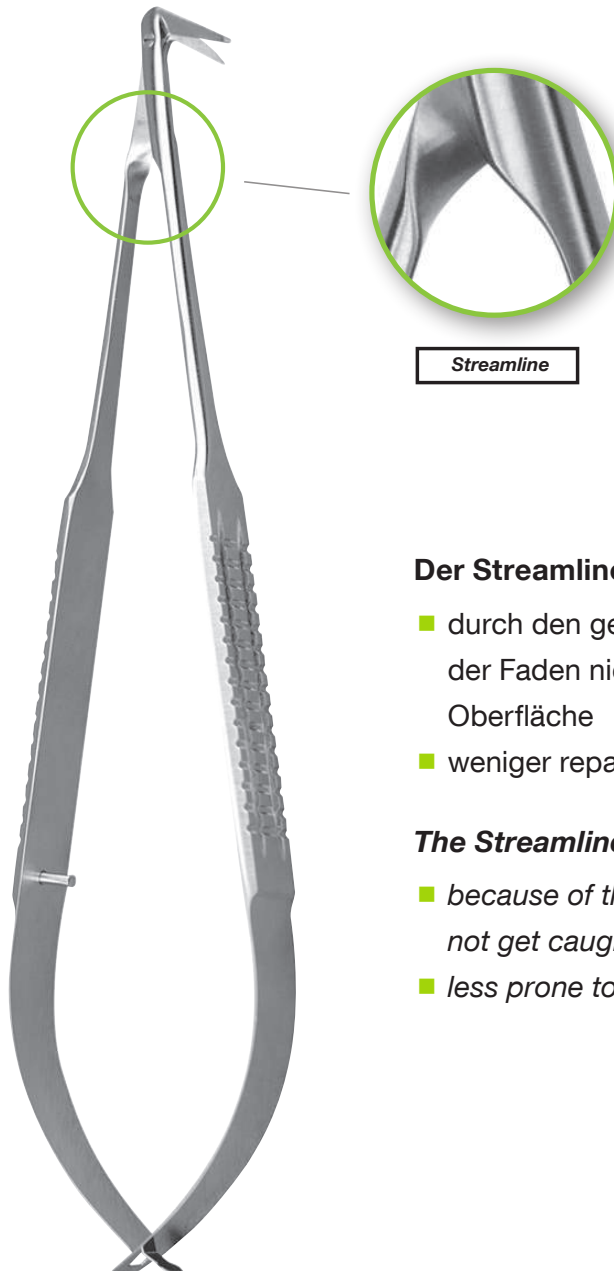

Streamline

Der Streamline-Schluss bietet Vorteile:

- durch den geschwungenen Schluss verfängt sich der Faden nicht mehr, sondern gleitet über die Oberfläche
- weniger reparaturanfällig

The Streamline lock offers advantages:

- *because of the curved lock design the suture does not get caught and slides over the surface*
- *less prone to repairs*

Gefäßscheren, Flachgriff Vascular Scissors, Flat Handle

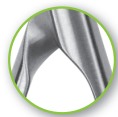

Streamline



25°



45°



60°



90°



125°

Mit Knopf, spitz, gewinkelt
probe-pointed, sharp, angled

18 cm – 7"

RU 1770-25R	RU 1770-45R	RU 1770-60R	RU 1770-90R	RU 1770-99R
-------------	-------------	-------------	-------------	-------------



Streamline



25°



45°



60°



90°



125°

spitz, gewinkelt
sharp, angled

18 cm – 7"

RU 1771-25R	RU 1771-45R	RU 1771-60R	RU 1771-90R	RU 1771-99R
-------------	-------------	-------------	-------------	-------------

Gefäßscheren, Rundgriff Vascular Scissors, Round Handle



Streamline



25°



45°



60°



90°



125°

Mit Knopf, spitz, gewinkelt
probe-pointed, sharp, angled

17,5 cm – 7"		17 cm – 6¾"	16,5 cm – 6½"	
RU 1772-25R	RU 1772-45R	RU 1772-60R	RU 1772-90R	RU 1772-99R



Streamline



25°



45°



60°



90°



125°

spitz, gewinkelt
sharp, angled

17,5 cm – 7"		17 cm – 6¾"	16,5 cm – 6½"	
RU 1773-25R	RU 1773-45R	RU 1773-60R	RU 1773-90R	RU 1773-99R

Nerv-Präparierschere
Nerve dissecting scissors



gebogen
curved

15,5 cm – 6"

RU 1792-15

Tonsillen-Scheren Tonsil Scissors



Arteriotomie Schere
Arteriotomy scissors



TÖNNIS-ADSON FINO



gebogen
curved

17,5 cm – 7"

RU 1819-17

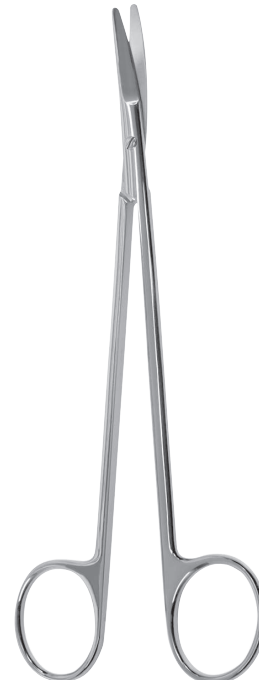

TÖNNIS



gebogen
curved

18 cm – 7"

RU 1821-18

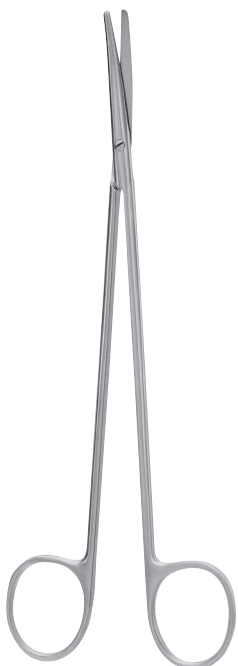

TÖNNIS-ADSON



gebogen
curved



Typ / Type 17,5 cm – 7"

RU 1825-17

TC **RU 1829-17**



BÖTTCHER



stumpf / stumpf
gebogen
*blunt / blunt
curved*

18 cm – 7"

RU 1810-18



GOOD



gebogen
curved

19 cm – 7½"

RU 1845-19

Darmscheren
Enterotomy Scissors



Ligaturscheren Ligature Scissors



Speziell zum Schneiden von Nahtmaterial:

- Schneiden mit aufgeschweißtem Hartmetall für erhöhte Standzeit
- fein gezahntes Blatt verhindert ein Herausrutschen des Nahtmaterials
- weit auslaufender Schluss verhindert ein Einklemmen oder Verfangen des Nahtmaterials
- weit ausgestellte Griffbranchen für optimierte Handhabung

Especially for the cutting of suture material:

- blades with welded hard metal for extended lifetime
- fine serrated blade prevents the slipping of suture material
- smoothly widening lock design prevents the suture material from getting caught in the parts of the scissors
- flared shanks for optimized handling



gebogen
curved

Typ / Type	14,5 cm – 5¾"	18 cm – 7"	23 cm – 9"
TC	RU 1314-14RS	RU 1334-18RS	RU 1334-23RS



SPENCER



Typ / Type

	9 cm – 3½"	RU 2510-09
HP	9 cm – 3½"	RU 2510-09HP
	10,5 cm – 4¼"	RU 2510-10
	12 cm – 4¾"	RU 2510-12



gerade
straight



SPENCER-FINO



gerade
straight

11 cm – 4¼"
RU 2512-11

Ligaturscheren Ligature Scissors



LITTAUER



gerade
straight

14 cm – 5½"

RU 2500-14



SHORTBENT



gebogen
curved

9 cm – 3½"

RU 2520-09



NORTHBENT



gebogen
curved

12,5 cm – 5"

RU 2520-12



gewinkelt
angled

12,5 cm – 5"

RU 2522-11

Präparierschere mit Fadenbohrung
Dissecting scissors with suture hole



LITTLER



gebogen
curved

11,5 cm – 4½"

RU 2526-11



SIMS



stumpf / stumpf
blunt / blunt

Typ
Type

gerade
straight

gebogen
curved

20 cm – 8"		RU 1401-20	RU 1411-20
	MC	RU 1401-20M	–
23 cm – 9"		–	RU 1411-23



SIMS



stumpf / stumpf
blunt / blunt

Typ
Type

gebogen
curved

20 cm – 8"	TC	RU 1414-20
23 cm – 9"	TC	RU 1414-23

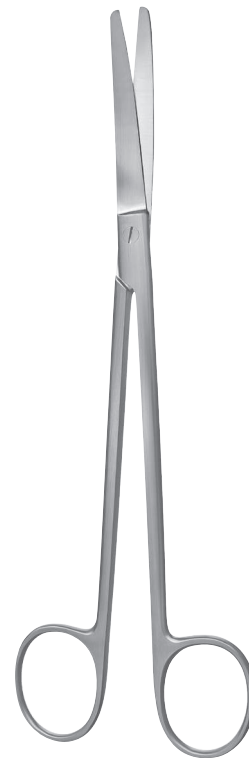

WERTHEIM



gebogen
curved

22,5 cm – 8¾"
RU 1415-22



DOYEN



				
Typ / Type		spitz / stumpf sharp / blunt	stumpf / stumpf blunt / blunt	
		gerade straight	gerade straight	gebogen curved
16 cm – 6¼"		RU 1428-16	RU 1430-16	RU 1431-16
18 cm – 7"		–	RU 1430-18	–
18 cm – 7"	HP	–	RU 1430-18HP	–

Fistelschere
Fistula scissors



KELLY



		
Typ / Type		gebogen curved
	16 cm – 6¼"	RU 1441-16
TC		RU 1445-16



Uterusschere
Uterine scissors



SIEBOLD

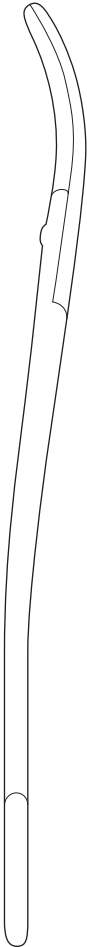

S-gebogen
S-curved



S-gebogen
S-curved

24 cm – 9½"

RU 1455-24



BUSCH



gebogen
curved

16 cm – 6¼"

RU 2000-16



SCHUMACHER

16 cm – 6¼"

RU 2010-16



**MODELL USA
USA PATTERN**

10,5 cm – 4¼"

RU 2020-10

Damm-(Episiotomie-) Scheren Perineum (Episiotomy) Scissors



Typ / Type	14 cm – 5½"	22 cm – 8¾"
	RU 2050-14	RU 2055-22
MC	–	RU 2055-22M

BRAUN-STADLER



gewinkelt
angled



Typ / Type	18 cm – 7"
	RU 2085-18
MC	RU 2085-18M

WALDMANN



geknöpft
gezahnt
probe-pointed
serrated



Typ / Type	19 cm – 7½"
	RU 2086-19
MC	RU 2086-19M
TC	RU 2087-19



gezahnt
serrated

Parametriumscheren
Parametrium Scissors



TC
Hard Metal



gebogen
curved

TC	23 cm – 9"	RU 2090-11	RU 2090-14
-----------	------------	-------------------	-------------------



BEEBEE



spitz / spitz
gerade
sharp / sharp
straight

10,5 cm – 4¼"

RU 2870-10



BEEBEE



stumpf / stumpf
gerade, gezahnt
blunt / blunt
straight, serrated



stumpf / stumpf
gebogen, gezahnt
blunt / blunt
curved, serrated

12 cm – 4¾"

RU 2890-12

RU 2891-12



DEAN



gewinkelt, gezahnt
angled, serrated

17 cm – 6¾"

RU 2913-17



LOCKLIN



gewinkelt, gezahnt
angled, serrated

16,5 cm – 6½"

RU 2918-16



LA GRANGE

S-gebogen
S-curved



S-gebogen, gezahnt
S-curve, serrated

11,5 cm – 4½"

RU 2932-11



gerade
straight



gebogen
curved

Typ / Type

11 cm – 4¼"

	RU 2940-11	RU 2941-11
HP	RU 2940-11HP	RU 2941-11HP

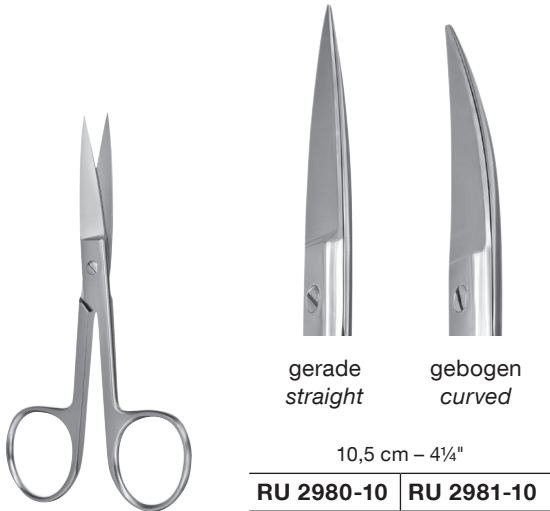

Nagelspaltschere
Nail splitting scissors





Drahtschere
Wire cutting scissors



HP
High polished

TC
Hard Metal



gewinkelt
angled

Typ / Type	12,5 cm - 5"
	RU 2600-12
HP	RU 2600-12HP
TC	RU 2601-12



RUDOLF

geknöpft
gewinkelt
probe-pointed
angled

	16 cm – 6¼"
schwarz <i>black</i>	RU 2602-16





geknöpft
gewinkelt
probe-pointed
angled

	18 cm – 7"
schwarz <i>black</i>	RU 2602-18



LISTER

	 	Typ Type	geknöpft gewinkelt <i>probe-pointed</i> <i>angled</i>
11 cm – 4¼"			RU 2650-11
14,5 cm – 5¾"			RU 2650-14
15,5 cm – 6"		MC	RU 2650-14M
			RU 2650-15
			RU 2650-18
18 cm – 7"		MC	RU 2650-18M
		TC	RU 2651-18
20 cm – 8"			RU 2650-20
		MC	RU 2650-20M



LISTER

		geknöpft gewinkelt <i>probe-pointed</i> <i>angled</i>
Typ / Type		21 cm – 8¼"
		RU 2652-21
TC		RU 2653-21



Obere Schneide gezahnt
upper blade serrated

geknöpft
gewinkelt
*probe-pointed
angled*

16 cm – 6¼"	RU 2654-16
19 cm – 7½"	RU 2654-19

LISTER-EXCENTRIC



geknöpft
gewinkelt
*probe-pointed
angled*

20 cm – 8"	22 cm – 8¾"
RU 2655-20	RU 2655-22

ESMARCH



geknöpft
gewinkelt
*probe-pointed
angled*

23 cm – 9"
RU 2660-23

BERGMANN

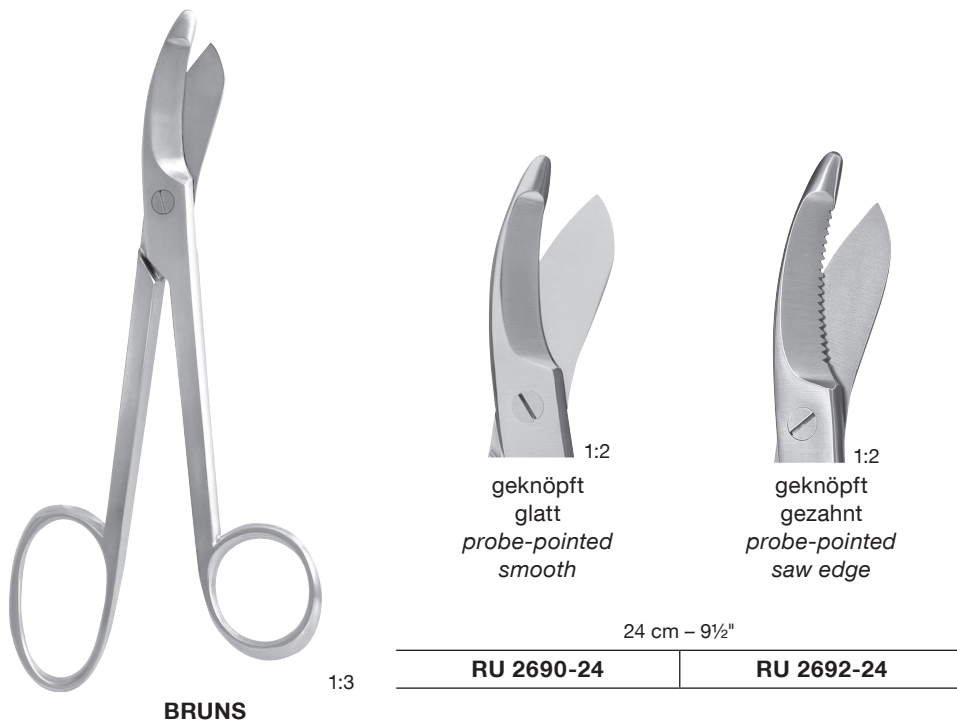

Gipsscheren
Plaster Shears



STILLE

23 cm – 9"	RU 2840-23
26 cm – 10¼"	RU 2840-26
37 cm – 14½"	RU 2840-37

Knochenscheren
Bone Scissors



SEUTIN

geknöpft
kniegebogen
gezahnt
probe-pointed
curved to side
serrated

23 cm – 9"

RU 2715-23



COLLIN

22 cm – 8¾"

RU 2805-22



Skalpelle	<i>Scalpels</i>	SK 1 - 4
Rasierklingen, Rasierklingenbrecher und -halter	<i>Razor Blades, Razor Blade Breaker and -Holder</i>	SK 5 - 6
Anatomische Skalpelle	<i>Dissecting Knives</i>	SK 7
Amputationsmesser	<i>Amputation Knives</i>	SK 8
Resektions- und Seziermesser	<i>Resection- and Autopsy Knives</i>	SK 9
Dermatome	<i>Dermatomes</i>	SK 10

Mini-Klingen-System
Mini-Blade-System

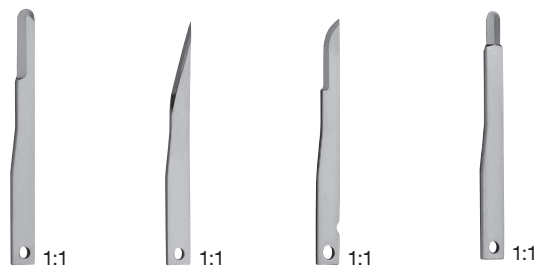

steril, Verpackungseinheit à 10 Klingen
sterile, Packing unit 10 blades

Fig. 64	Fig. 65	Fig. 67	Fig. 69
RU 4853-64	RU 4853-65	RU 4853-67	RU 4853-69



10 cm – 4"

RU 4853-33



13,5 cm – 5¼"

RU 4853-34



15,5 cm – 6"

RU 4853-35



CASPAR

18 cm – 7"

RU 4854-03



20 cm – 8"

RU 4854-04

Verpackungseinheit à 100 Klengen
Packing unit 100 blades

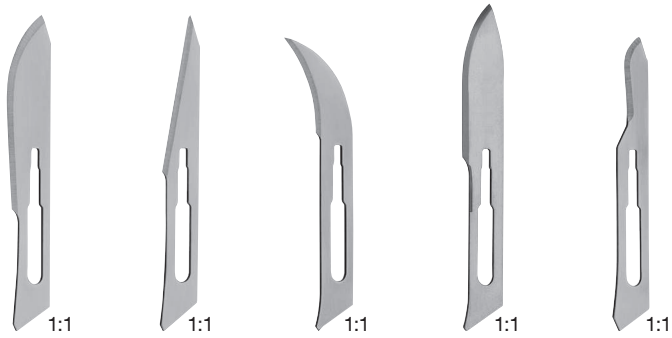

	Fig. 10	Fig. 11	Fig. 12	Fig. 13	Fig. 15
unsteril <i>non-sterile</i>	RU 4851-10	RU 4851-11	RU 4851-12	RU 4851-13	RU 4851-15
steril <i>sterile</i>	RU 4852-10	RU 4852-11	RU 4852-12	RU 4852-13	RU 4852-15



No. 3

12,5 cm – 5"

RU 4850-03



No. 3

12,5 cm – 5"

RU 4850-13



No. 7

16 cm – 6¼"

RU 4850-07



No. 7 K

12 cm – 4¾"

RU 4850-17

Verpackungseinheit à 100 Klagen
Packing unit 100 blades

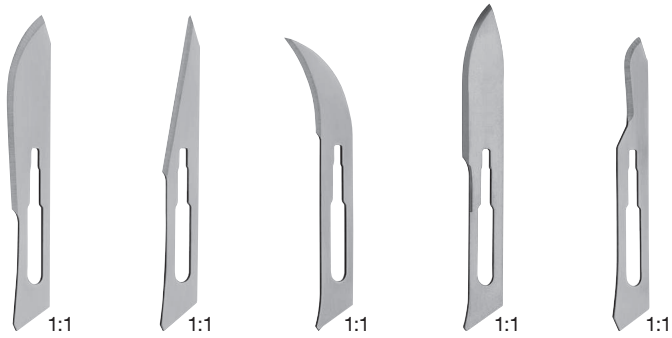

	Fig. 10	Fig. 11	Fig. 12	Fig. 13	Fig. 15
unsteril <i>non-sterile</i>	RU 4851-10	RU 4851-11	RU 4851-12	RU 4851-13	RU 4851-15
steril <i>sterile</i>	RU 4852-10	RU 4852-11	RU 4852-12	RU 4852-13	RU 4852-15



No. 3 L

21 cm – 8¼"

RU 4850-31



No. 3 LA

21 cm – 8¼"

RU 4850-32

abgewinkelt
angled



No. 5

15 cm – 6"

RU 4850-50



No. 5 A

15 cm – 6"

RU 4850-51

abgewinkelt
angled

Verpackungseinheit à 100 Klungen
Packing unit 100 blades



	Fig. 18	Fig. 19	Fig. 20	Fig. 21	Fig. 22	Fig. 23
unsteril <i>non-sterile</i>	RU 4851-18	RU 4851-19	RU 4851-20	RU 4851-21	RU 4851-22	RU 4851-23
steril <i>sterile</i>	RU 4852-18	RU 4852-19	RU 4852-20	RU 4852-21	RU 4852-22	RU 4852-23



No. 4
13,5 cm – 5¼"
RU 4850-04



No. 4
13,5 cm – 5¼"
RU 4850-14



No. 4 L
21 cm – 8¼"
RU 4850-41



No. 4 LA
21 cm – 8¼"
RU 4850-42

abgewinkelt
angeld

Rasierklingen, Rasierklingenbrecher und -halter Razor Blades, Razor Blade Breaker and Holder



Öffnen durch
Zurückschieben
der Hülse
*To open push
back the sleeve*



RU 4874-00

Rasierklingen,
Verpackungseinheit
à 10 Klingen
*Razor Blades,
Packing unit
10 blades*



Griffdurchmesser
Handle diameter
Ø 5,5 mm

TROUTMAN-CHRIS



gerade
straight



gewinkelt
angled

9 cm – 3½"

RU 4876-09 | **RU 4877-09**



CASTROVIEJO

Rasierklingenhalter
mit Riegelschloss
*Razor blade holder
with slide catch*

Griffdurchmesser
Handle diameter
Ø 8 mm



gerade
straight

12,5 cm – 5"

RU 4878-13



CASTROVIEJO

Schweizer Modell
Swiss pattern



gerade, glatt
straight, smooth

12 cm – 4¾"

RU 4878-33

Rasierklingen, Rasierklingenbrecher und -halter Razor Blades, Razor Blade Breaker and Holder



Öffnen durch
Zurückschieben
der Hülse
*To open push
back the sleeve*



RU 4874-00

Rasierklingen,
Verpackungseinheit
à 10 Klingen
*Razor Blades,
Packing unit
10 blades*

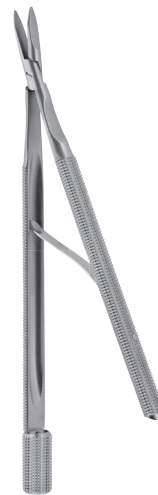

Maulinnenseite:
konkav/konvex
*Jaw inside:
concave/convex*

gerade
straight

13 cm – 5"

RU 4878-23



Rasierklingenbrecher
Razor blade breaker



gerade
straight

18,5 cm – 7¼"

RU 4879-18



Rasierklingenhalter
mit Sperre
*Razor blade holder
with ratchet*



gerade
straight

11 cm – 4¼"

RU 4878-53

BARRAQUER

Anatomische Skalpelle Dissecting Knives



mit Metallheft
with metal handle



Fig. 1	Fig. 2	Fig. 3	Fig. 4	Fig. 5
RU 4858-01	RU 4858-02	RU 4858-03	RU 4858-04	RU 4858-05

spitz
pointed



Fig. 6	Fig. 7	Fig. 8	Fig. 9	Fig. 10
RU 4858-06	RU 4858-07	RU 4858-08	RU 4858-09	RU 4858-10

Amputationsmesser Amputation Knives

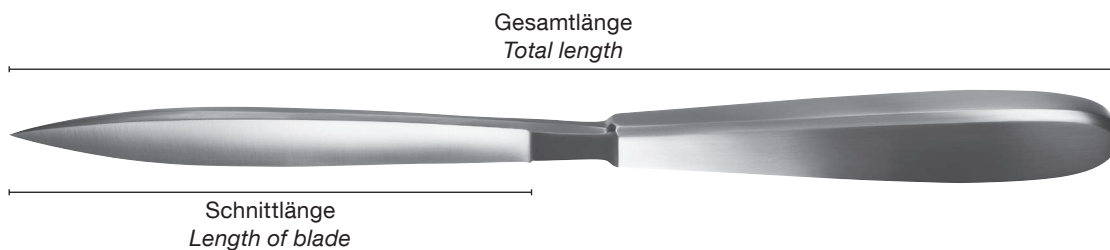

LISTON

Gesamtlänge <i>Total length</i>	Schnittlänge <i>Length of blade</i>	
26 cm – 10¼"	13 cm – 5"	RU 4880-13
29 cm – 11½"	16 cm – 6¼"	RU 4880-16
32 cm – 12½"	19 cm – 7½"	RU 4880-19
35 cm – 13¾"	22 cm – 8¾"	RU 4880-22



LISTON

Gesamtlänge <i>Total length</i>	Schnittlänge <i>Length of blade</i>	
31 cm – 12¼"	17 cm – 6¾"	RU 4881-17
34 cm – 13½"	20 cm – 8"	RU 4881-20

Resektions- und Seziermesser Resection- and Autopsy Knives

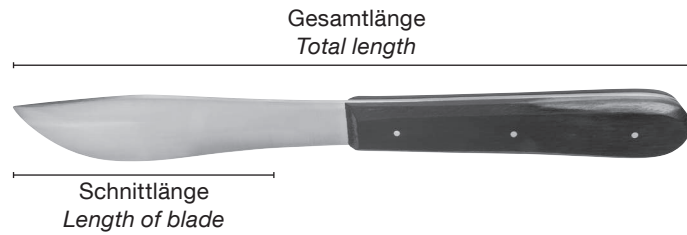

Resektionsmesser
Resection knife

Gesamtlänge Total length	Schnittlänge Length of blade	
18 cm – 7"	5,5 cm – 2¼"	RU 4888-05

LANGENBECK



Seziermesser
Autopsy knife

Gesamtlänge Total length	Schnittlänge Length of blade	
27 cm – 10½"	12 cm – 4¾"	RU 4892-11

1:3



Seziermesser
Autopsy knife

Gesamtlänge Total length	Schnittlänge Length of blade	
23 cm – 9"	9 cm – 3½"	RU 4894-09

1:3

VIRCHOW



Dermatom **SCHINK**, einstellbar von 0,1 mm - 2,0 mm,
komplett mit 1 x auswechselbarer Klinge RU 4899-01 und
2 Spannplatten RU 4899-02
*Dermatome **SCHINK**, adjustable from 0.1 mm - 2.0 mm,
complete with 1 exchangeable blade RU 4899-01 and
2 straightening plates RU 4899-02*

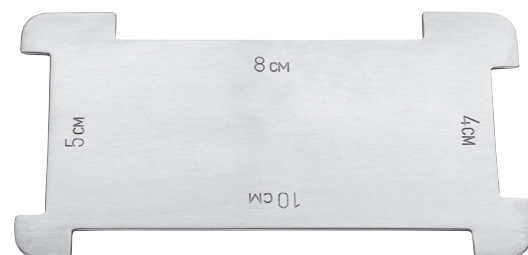

Spannplatte allein für alle Dermatome verwendbar
Skin straightening plate only usable for all dermatomes

RU 4899-02



Mikro-Uhrmacher Pinzetten	<i>Micro Jewelers Forceps</i>	FC 1
Mikro-Nahtpinzetten	<i>Micro Suture Forceps</i>	FC 2 - 3
Anatomische Mikro-Pinzetten	<i>Dissecting Micro Forceps</i>	FC 4 - 7
Mikro-Tumorfaßpinzetten	<i>Micro Tumor Grasping Forceps</i>	FC 8 - 9
Mikro-Pinzetten, Rundgriff	<i>Micro Forceps, Round Handle</i>	FC 10
Feine anatomische Pinzetten	<i>Delicate Dissecting Forceps</i>	FC 11 - 18
Anatomische Pinzetten	<i>Dissecting Forceps</i>	FC 19 - 21
Atraumatische Pinzetten	<i>Atraumatic Forceps</i>	FC 22
Ohrpinzetten	<i>Ear Dressing Forceps</i>	FC 23 - 24
Feine chirurgische Pinzetten	<i>Delicate Tissue Forceps</i>	FC 25 - 32
Chirurgische Pinzetten	<i>Tissue Forceps</i>	FC 33 - 36
Hautpinzetten	<i>Skin Forceps</i>	FC 37
Darm- und Lungenpinzetten	<i>Intestinal and Lung Forceps</i>	FC 38
Fasspinzetten	<i>Grasping Forceps</i>	FC 39
Splitterpinzetten	<i>Splinter Forceps</i>	FC 40
Splitterzangen	<i>Splinter Forceps</i>	FC 41
Cilienpinzetten	<i>Cilia Forceps</i>	FC 42

Mikro-Uhrmacher-Pinzetten Micro Jewelers Forceps

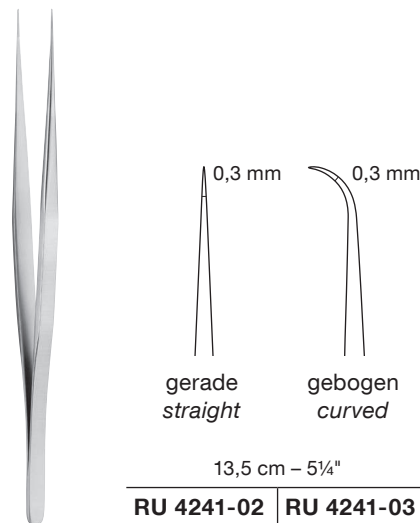
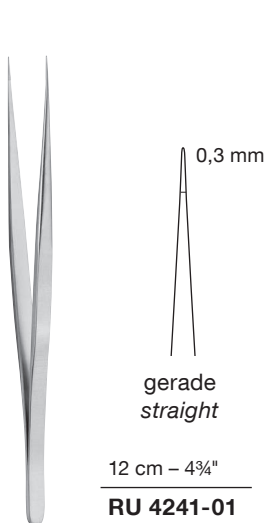
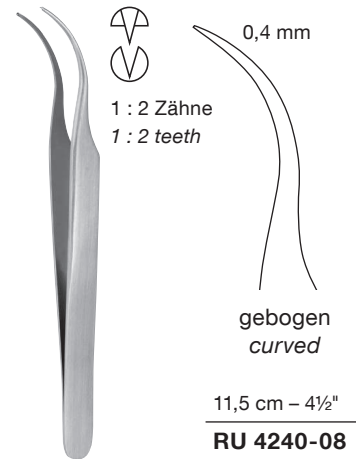
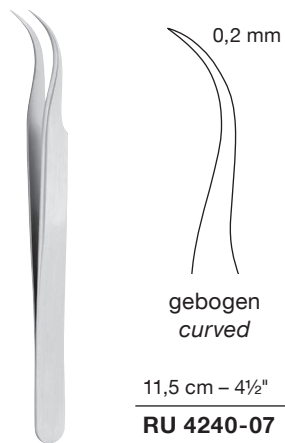
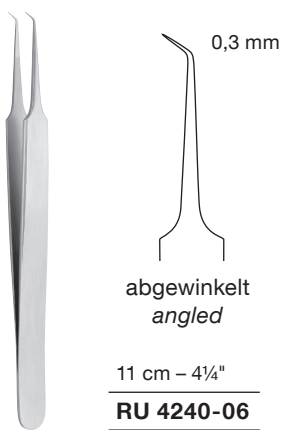
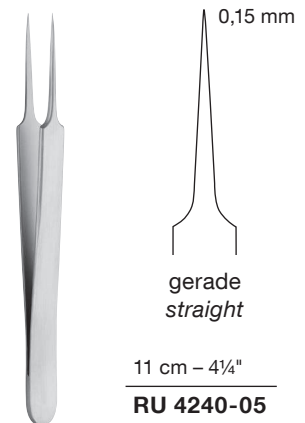
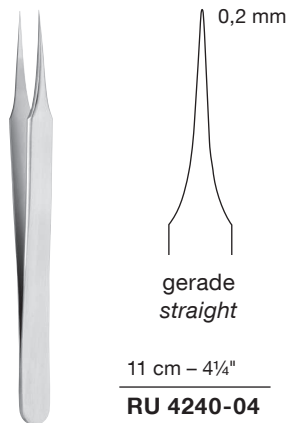
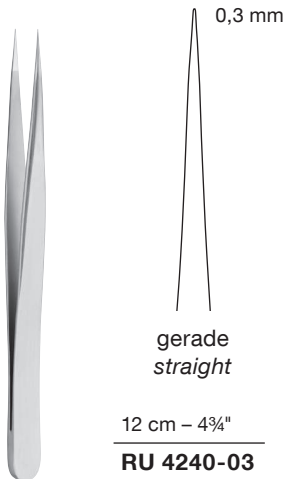

WISE

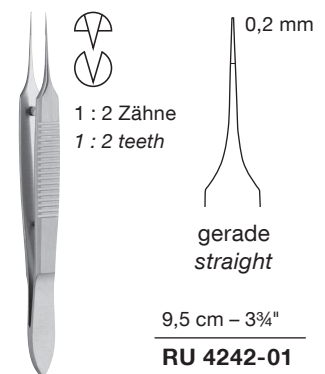

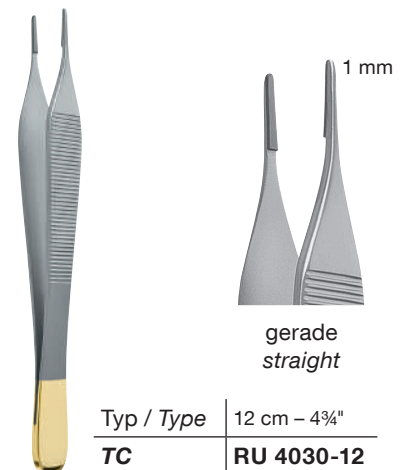
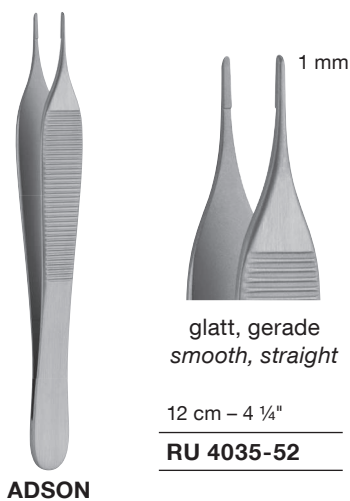
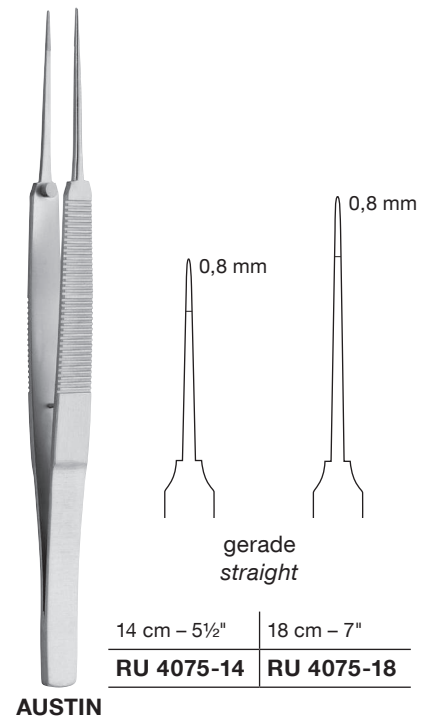
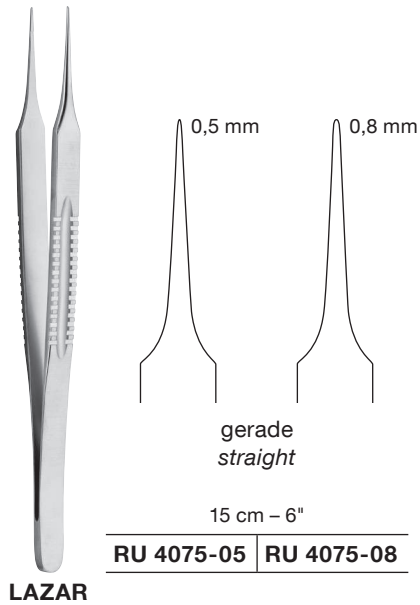
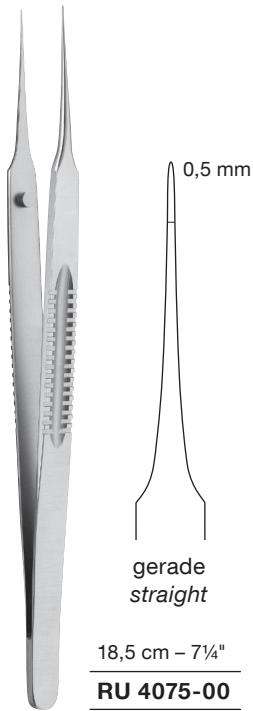

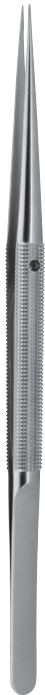

gerade
straight



gebogen
curved



gerade
straight



1 : 2 Zähne
1 : 2 teeth

	Spitze Tip	mit Fadenplatte, 6 mm with tying platform, 6 mm		
12 cm – 4¾"	0,4 mm	RU 4068-12	RU 4069-12	–
15 cm – 6"	0,4 mm	RU 4068-15	RU 4069-15	RU 4068-32
18 cm – 7"	0,4 mm	RU 4068-18	RU 4069-18	RU 4068-42
	0,8 mm	RU 4068-19	RU 4069-19	RU 4068-44
21 cm – 8¼"	0,8 mm	RU 4068-21	RU 4069-21	RU 4068-46

gerade
straight

gebogen
curved

gerade
straight

	Type	Spitze Tip	mit Fadenplatte, 6 mm with tying platform, 6 mm		
18 cm – 7"	TI	0,4 mm	RU 4068-18T	RU 4069-18T	RU 4068-42T
	TI	0,8 mm	RU 4068-19T	RU 4069-19T	RU 4068-44T
21 cm – 8¼"	MC	0,8 mm	RU 4068-22U	RU 4069-22U	–

Mikro-Nahtpinzetten Micro Suture Forceps



0,6 mm



0,6 mm



0,6 mm



1 : 2 Zähne
1 : 2 teeth

Typ Spitze
Type Tip

gerade
straight

gebogen
curved

gerade
straight

15 cm – 6"	MG	0,6 mm	RU 4068-51G	RU 4068-52G	RU 4068-63G
18 cm – 7"	MG	0,6 mm	RU 4068-53G	RU 4068-54G	–
21 cm – 8¼"	MG	0,6 mm	RU 4068-55G	RU 4068-56G	–

Anatomische Mikro-Pinzetten

Dissecting Micro Forceps



bajonettförmig
bayonet-shaped

YASARGIL

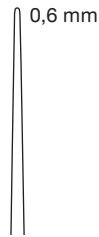

glatt, gerade
smooth, straight

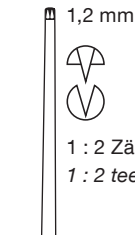
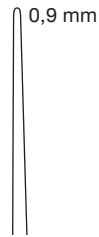

gerade
straight

16 cm – 6¼"	RU 4063-22	RU 4063-24	–
18 cm – 7"	RU 4063-32	RU 4063-34	RU 4063-36
20 cm – 8"	RU 4063-42	RU 4063-44	–
22 cm – 8¾"	RU 4063-52	RU 4063-54	–
24 cm – 9½"	RU 4063-62	RU 4063-64	–

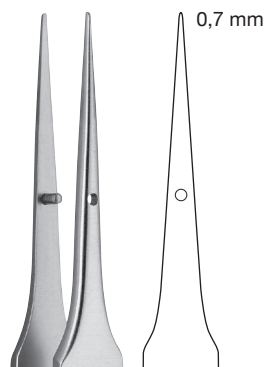

gerade
straight

15 cm – 6"	RU 4065-15
18 cm – 7"	RU 4065-18

JACOBSON



bajonettförmig
bayonet-shaped



gerade
straight

16 cm – 6¼"	RU 4078-16
-------------	-------------------



21 cm – 8¼"

RU 4078-25

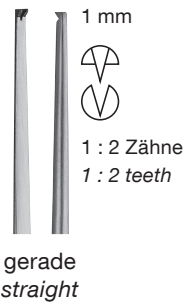

16 cm – 6¼"

RU 4296-01 **RU 4296-02**



18,5 cm – 7¼"

RU 4296-06

Anatomische Mikro-Pinzetten

Dissecting Micro Forceps



bajonettförmig
bayonet-shaped

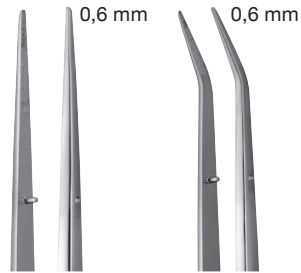

gerade
straight

gewinkelt, 40°
angled, 40°

Typ / Type	19 cm – 7½"	
MG	RU 4078-30G	RU 4078-31G



bajonettförmig
bayonet-shaped

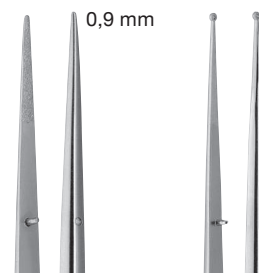

gerade
straight

gerade
straight

A = Ø 1 mm
B = Ø 0,5 mm



Ring-Spitze
glatt
Ring tip
smooth



Typ / Type	22 cm – 8¾"	
MG	RU 4078-40G	RU 4078-41G



Mikro-Tumorfasspinzetten

Micro Tumor Grasping Forceps





bajonettförmig
bayonet-shaped

			
	Maul löffelförmig Jaw spoon shaped	Maul flach gezahnt Jaw flat serrated	Maul kürettenförmig Jaw curette shaped
22 cm – 8¾"	RU 4078-01	RU 4078-03	RU 4078-05

			
	Maul löffelförmig Jaw spoon shaped	Maul flach gezahnt Jaw flat serrated	Maul kürettenförmig Jaw curette shaped
22 cm – 8¾"	RU 4078-02	RU 4078-04	RU 4078-06



bajonettförmig
bayonet-shaped

			
	Maul löffelförmig Jaw spoon shaped	Maul flach gezahnt Jaw flat serrated	Maul abgewinkelt Jaw curette angled
20 cm – 8"	RU 4078-10	RU 4078-11	RU 4078-60

HUNT



Mikro-Tumorfasspinzetten



Micro Tumor Grasping Forceps



YASARGIL

leichter Lochgriff,
bajonettförmig
*light perforated handle,
bayonet-shaped*

	 Ø 3 mm	 Ø 5 mm	 Ø 7 mm
22 cm – 8¾"	RU 4064-51	RU 4064-52	–
24 cm – 9½"	RU 4064-61	RU 4064-62	RU 4064-63

	 Ø 3 mm	 Ø 3 mm
22 cm – 8¾"	RU 4064-54	RU 4064-55

	 Ø 5 mm	 Ø 5 mm
22 cm – 8¾"	RU 4064-57	RU 4064-58

Mikro-Pinzetten, Rundgriff Micro Forceps, Round Handle

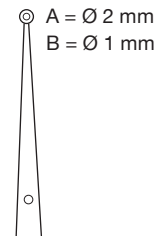
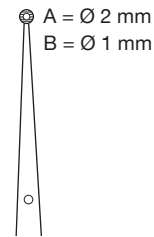
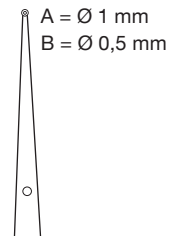
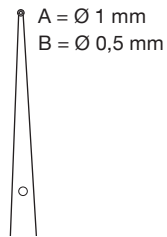
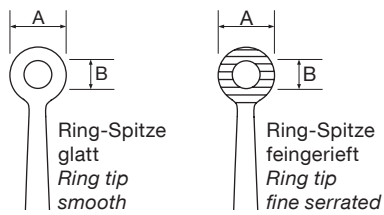

Typ
Type

feingerieft
fine serrated

glatt
smooth

feingerieft
fine serrated

glatt
smooth

15 cm – 6"	TI	RU 4079-12	RU 4079-14	–	–
18 cm – 7"		–	–	RU 4079-36	RU 4079-38
18 cm – 7"	TI	RU 4079-32T	RU 4079-34T	RU 4079-36T	RU 4079-38T
22 cm – 8¾"		RU 4079-52	RU 4079-54	RU 4079-56	RU 4079-58

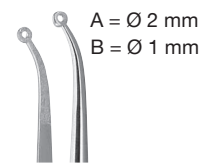
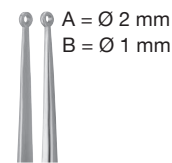
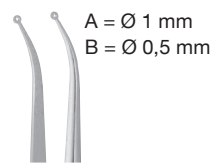
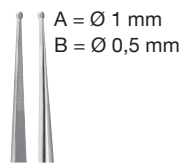

Typ
Type

gerade
straight

gebogen
curved

gerade
straight

gebogen
curved

15 cm – 6"	MG	RU 4068-74G	RU 4068-75G	–	–
15 cm – 6"	MG/TI	RU 4079-12U	–	RU 4079-16U	–
18 cm – 7"	MG	RU 4079-32G	RU 4079-33G	RU 4079-36G	RU 4079-37G
18 cm – 7"	MG/TI	RU 4079-32U	–	RU 4079-36U	–
21 cm – 8¼"	MG	RU 4079-42G	RU 4079-43G	RU 4079-46G	RU 4079-47G

Feine anatomische Pinzetten Delicate Dissecting Forceps



0,4 mm
glatt, gerade
smooth, straight

12 cm – 4¾"	RU 4033-12
15,5 cm – 6"	RU 4033-15

JACOBSON-ADSON



0,8 mm
fein, glatt,
gerade
*delicate, smooth,
straight*

Typ / Type	12 cm – 4¾"
TC	RU 4130-32

MICRO ADSON



1 mm
gerade
straight

12 cm – 4¾"	RU 4034-12
15 cm – 6"	RU 4034-15

MICRO ADSON

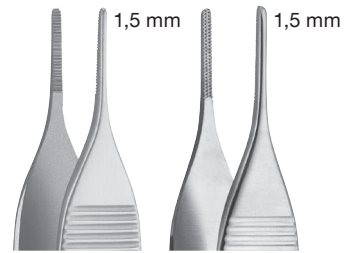

1,5 mm
gerade,
kreuzgerieft
*straight,
cross serrated*

12 cm – 4¾"	RU 4035-12	RU 4035-32
15 cm – 6"	RU 4035-15	–

ADSON STANDARD



1,7 mm
gerade
straight

12 cm – 4¾"	RU 4032-12
-------------	-------------------

EWALD



kreuzgerieft
cross serrated



1,5 mm
gerade
straight

12 cm – 4¾"	TC	RU 4036-12
15 cm – 6"	TC	RU 4036-15

ADSON

Feine anatomische Pinzetten Delicate Dissecting Forceps



DE BAKEY Zahnung
DE BAKEY Serration



gerade
straight

12,5 cm – 5"	RU 7585-12
15 cm – 6"	RU 7585-15

ADSON



gerade
straight

RU 4250-10



leicht gebogen
slightly curved

RU 4251-10



stark gebogen
strongly curved

RU 4252-10

10 cm – 4"



gerade
straight

12,5 cm – 5"	RU 4040-12	RU 4041-12
15 cm – 6"	RU 4040-15	RU 4041-15

SEMKEN



gebogen
curved



kreuzgerieft
cross serrated



gerade
straight

Typ / Type	15 cm – 6"
TC	RU 4042-15

SEMKEN



gerade
straight

15 cm – 6"	RU 4038-15
------------	-------------------

MC INDOE



gerade
straight

Typ / Type	15 cm – 6"
TC	RU 4039-15

MC INDOE

Feine anatomische Pinzetten Delicate Dissecting Forceps



gerade
straight

17,5 cm – 7"

RU 4048-18

BRAIN



gerade
straight

15 cm – 6"

RU 4055-15

18 cm – 7"

RU 4055-18

20 cm – 8"

RU 4055-20

WAUGH



glatt, gerade
smooth, straight

18 cm – 7"

RU 4056-18

20 cm – 8"

RU 4056-20

Feine anatomische Pinzetten Delicate Dissecting Forceps

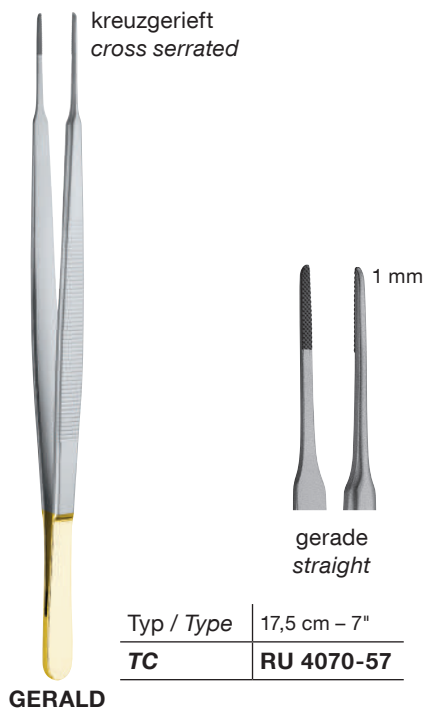
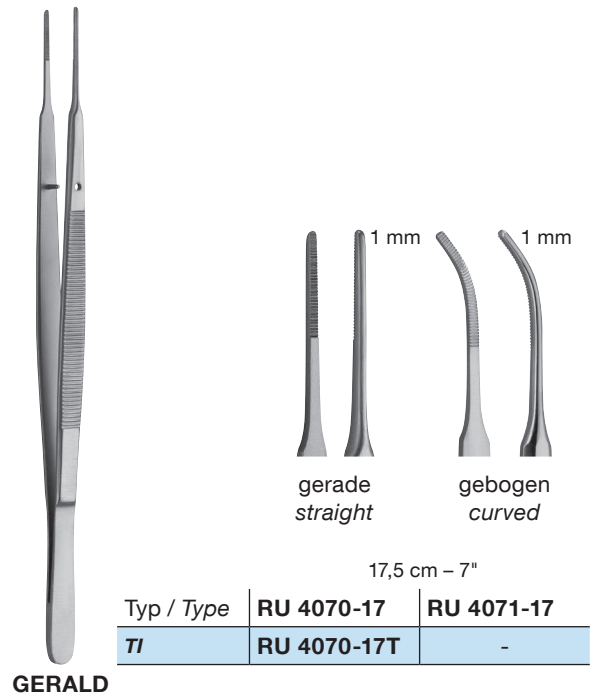
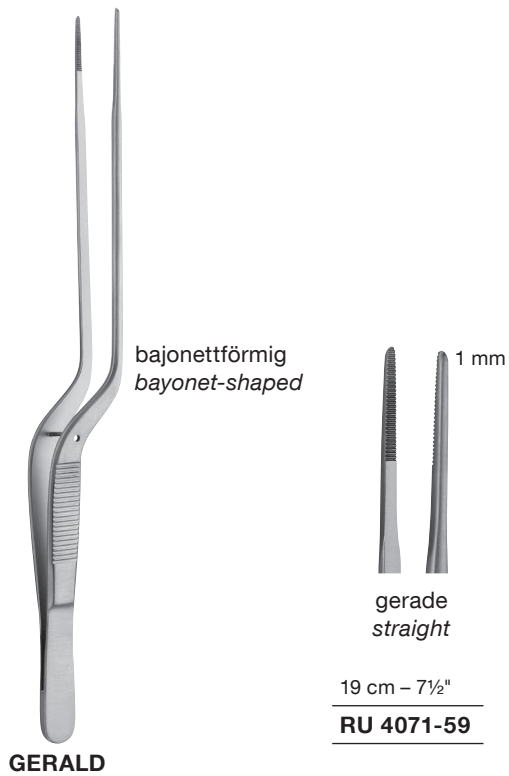

Feine anatomische Pinzetten Delicate Dissecting Forceps

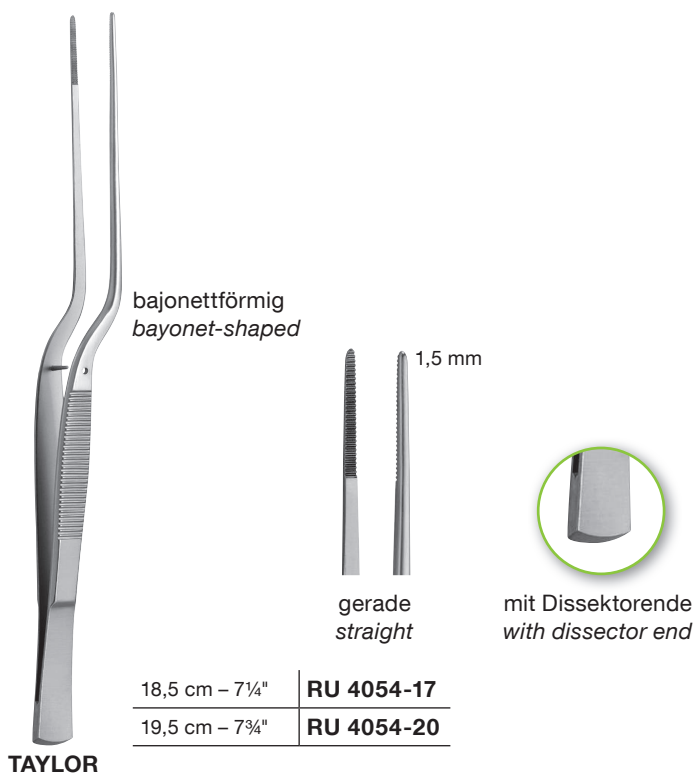
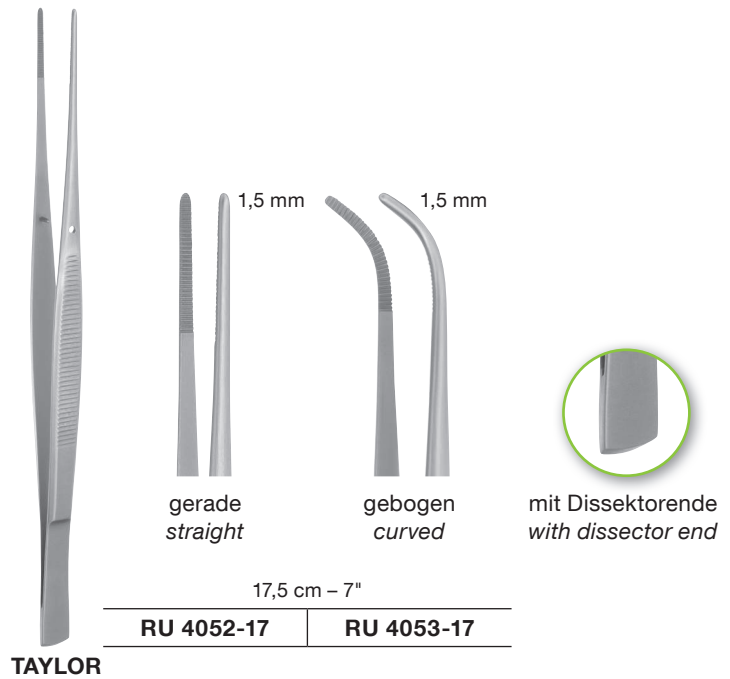
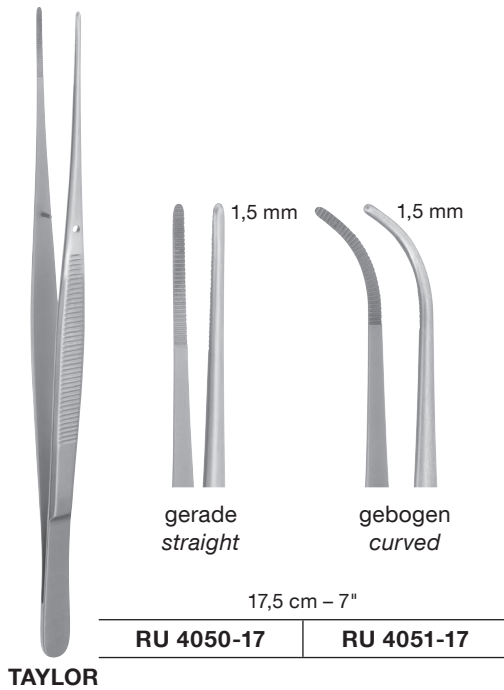

Feine anatomische Pinzetten Delicate Dissecting Forceps

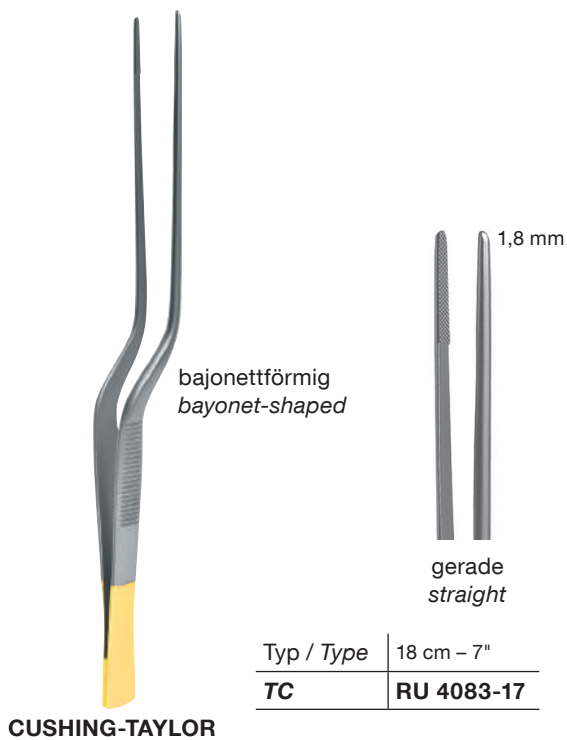
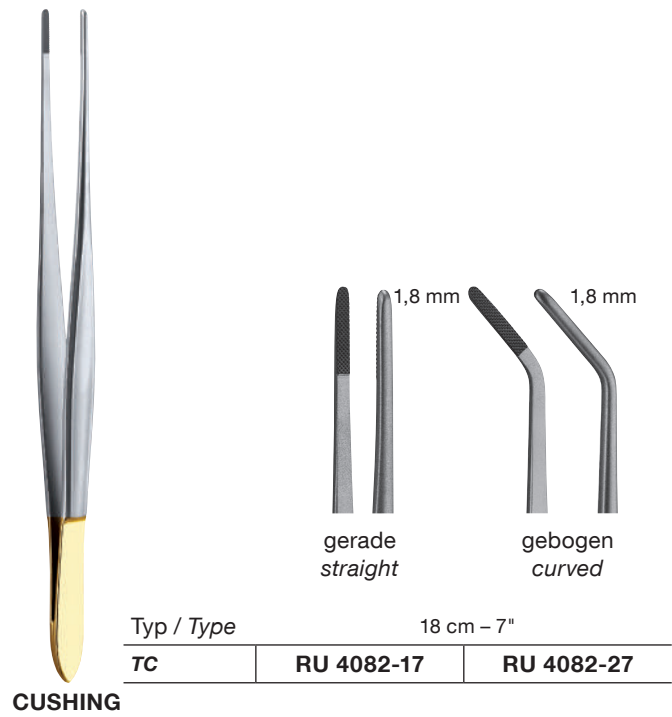
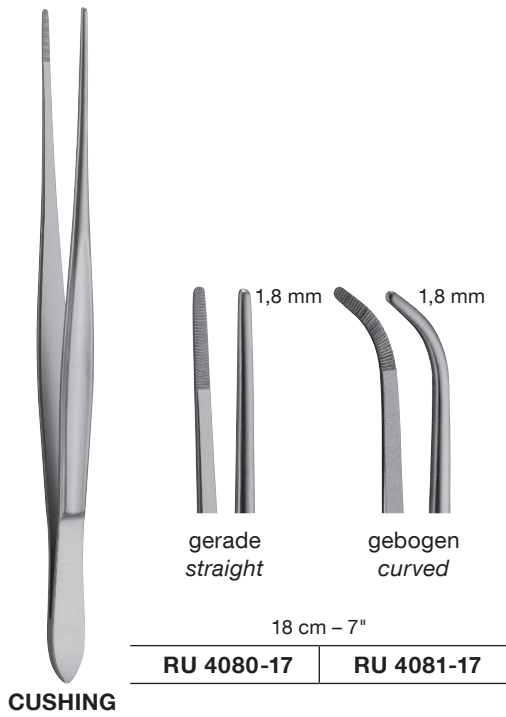

Feine anatomische Pinzetten Delicate Dissecting Forceps

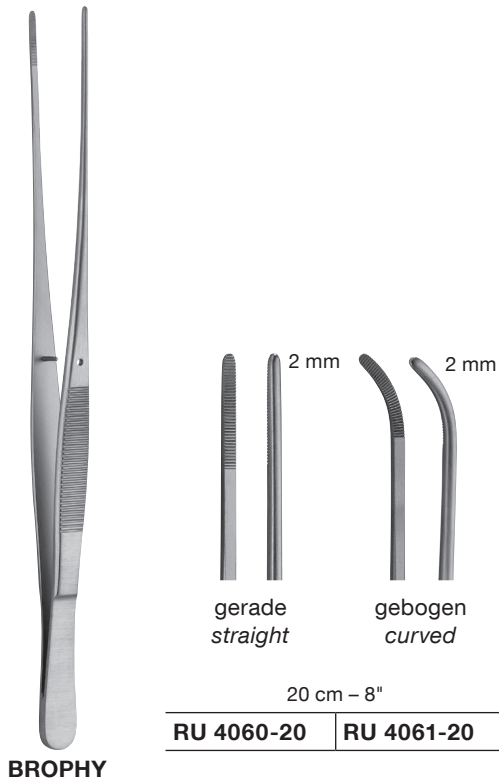

Feine anatomische Pinzetten Delicate Dissecting Forceps



POTTS-SMITH

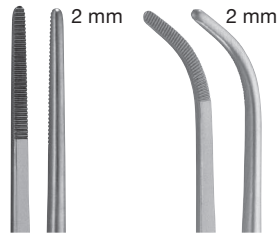

gerade
straight gebogen
curved

18 cm – 7"	RU 4090-18	RU 4091-18
21 cm – 8¼"	RU 4090-21	RU 4091-21
25 cm – 10"	RU 4090-25	RU 4091-25



POTTS-SMITH



Typ
Type gerade
straight

15 cm – 6"	TC	RU 4092-15
18 cm – 7"	TC	RU 4092-18
20 cm – 8"	TC	RU 4092-20
23 cm – 9"	TC	RU 4092-23
25 cm – 10"	TC	RU 4092-25



GRÜNWALD

bajonettförmig
bayonet-shaped



gerade
straight

Typ / <i>Type</i>	19 cm – 7½"
TC	RU 4084-18

Anatomische Pinzetten Dissecting Forceps



Standard







gerade
straight



gebogen
curved



2 mm
mittelbreit, gerade
medium, straight



2 mm
mittelbreit, gebogen
medium, curved

10,5 cm – 4¼"	RU 4000-10	–	–	–
11,5 cm – 4½"	RU 4000-11	RU 4001-11	RU 4010-11	RU 4011-11
13 cm – 5"	RU 4000-13	RU 4001-13	RU 4010-13	RU 4011-13
14,5 cm – 5¾"	RU 4000-14	RU 4001-14	RU 4010-14	RU 4011-14
15,5 cm – 6"	RU 4000-15	–	–	–
16 cm – 6¼"	RU 4000-16	RU 4001-16	RU 4010-16	RU 4011-16
18 cm – 7"	RU 4000-18	RU 4001-18	RU 4010-18	RU 4011-18
20 cm – 8"	RU 4000-20	RU 4001-20	RU 4010-20	RU 4011-20
25 cm – 10"	RU 4000-25	RU 4001-25	RU 4010-25	RU 4011-25
30 cm – 11¼"	RU 4000-30	RU 4001-30	RU 4010-30	RU 4011-30

Standard







2 mm
gerade
straight

	Typ <i>Type</i>	
14,5 cm – 5¾"	TC	RU 4002-14
16 cm – 6¼"	TC	RU 4002-16
18 cm – 7"	TC	RU 4002-18
20 cm – 8"	TC	RU 4002-20
25 cm – 10"	TC	RU 4002-25

Schwedisches Modell
Swedish pattern





gerade
straight

13 cm – 5"	RU 4013-13
15 cm – 6"	RU 4013-15
17 cm – 6¾"	RU 4013-17
20 cm – 8"	RU 4013-20

STILLE

Anatomische Pinzetten Dissecting Forceps

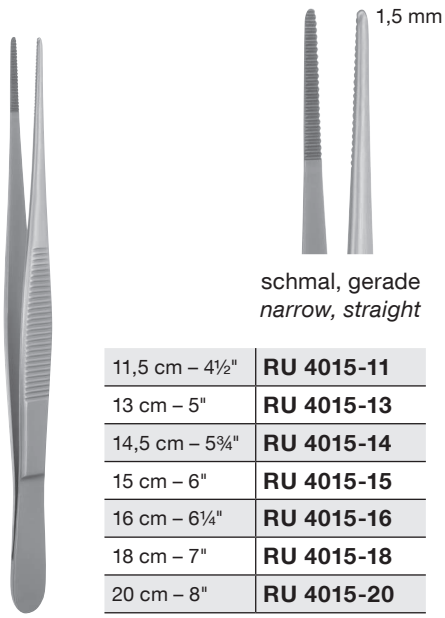

*schmal, gerade
narrow, straight*

11,5 cm – 4½"	RU 4015-11
13 cm – 5"	RU 4015-13
14,5 cm – 5¾"	RU 4015-14
15 cm – 6"	RU 4015-15
16 cm – 6¼"	RU 4015-16
18 cm – 7"	RU 4015-18
20 cm – 8"	RU 4015-20

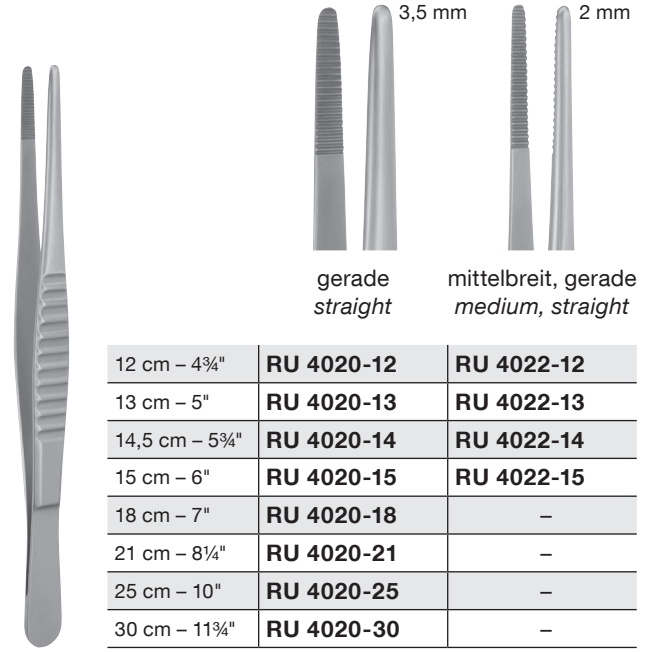

*gerade
straight*

*mittelbreit, gerade
medium, straight*

12 cm – 4¾"	RU 4020-12	RU 4022-12
13 cm – 5"	RU 4020-13	RU 4022-13
14,5 cm – 5¾"	RU 4020-14	RU 4022-14
15 cm – 6"	RU 4020-15	RU 4022-15
18 cm – 7"	RU 4020-18	–
21 cm – 8¼"	RU 4020-21	–
25 cm – 10"	RU 4020-25	–
30 cm – 11¾"	RU 4020-30	–

**MODELL USA
USA PATTERN**



*gerade
straight*

18 cm – 7"
RU 4059-18

BONNEY



2,5 mm
*Fadenpinzette
Suture forceps*

*gerade
straight*

14,5 cm – 5¾"
RU 4368-14

OCHSNER

Anatomische Pinzetten Dissecting Forceps



Typ
Type gerade
straight

15 cm – 6"	TC	RU 4085-15
23 cm – 9"	TC	RU 4085-23
25 cm – 10"	TC	RU 4085-25

WANGENSTEEN



gerade
straight

23 cm – 9"
RU 4086-23



Hypophysenpinzette
Pituitary forceps

bajonettförmig
bayonet-shaped



gerade
straight

23 cm – 9"
RU 4078-20

ADSON

Atraumatische Pinzetten Atraumatic Forceps



DE BAKEY Zahnung
DE BAKEY Serration

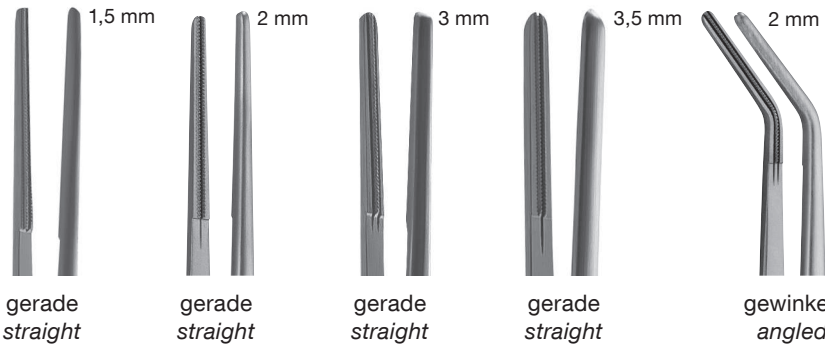

15 cm – 6"	RU 7580-16	RU 7581-16	RU 7582-16	RU 7583-16	RU 7584-16
20 cm – 8"	RU 7580-20	RU 7581-20	RU 7582-20	RU 7583-20	RU 7584-20
24 cm – 9½"	RU 7580-24	RU 7581-24	RU 7582-24	RU 7583-24	RU 7584-24
30 cm – 11¾"	RU 7580-30	RU 7581-30	RU 7582-30	RU 7583-30	RU 7584-30

DE BAKEY



DE BAKEY Zahnung
DE BAKEY Serration

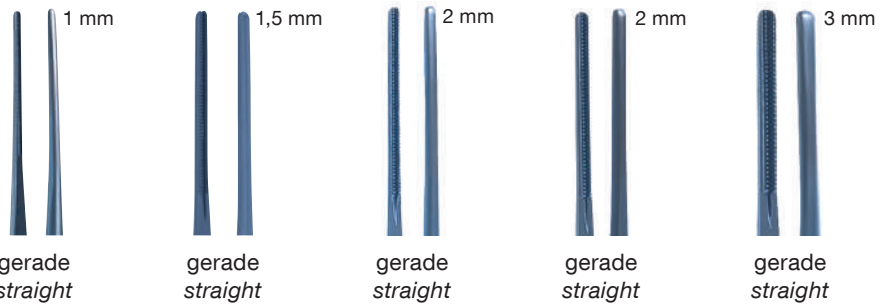

15 cm – 6"	TI	RU 7580-01T	RU 7580-16T	RU 7581-01T	RU 7582-01T	RU 7582-16T
20 cm – 8"	TI	RU 7580-02T	RU 7580-20T	RU 7581-02T	RU 7582-02T	RU 7582-20T
24 cm – 9½"	TI	RU 7580-03T	RU 7580-24T	RU 7581-03T	RU 7582-03T	RU 7582-24T

DE BAKEY

Ohrpinzetten Ear Dressing Forceps



bajonettförmig
bayonet-shaped

1 : 2 Zähne
1 : 2 teeth

14 cm – 5½"

1 mm	RU 7862-24	RU 7863-14
2 mm	RU 7862-14	–

LUCAE

Fixierpinzette
Fixing forceps

bajonettförmig
bayonet-shaped

2 mm

gerade, gezahnt,
gerieft
straight, toothed,
serrated

14 cm – 5½"

RU 7863-15

COTTLE

bajonettförmig
bayonet-shaped

1 : 2 Zähne
1 : 2 teeth

	2,2 mm	1 mm
16 cm – 6¼"	RU 7864-16	RU 7864-26
19,5 cm – 7¾"	RU 7864-18	RU 7864-28
21 cm – 8¼"	RU 7864-20	RU 7864-30

JANSSEN-GRUENWALD

bajonettförmig
bayonet-shaped

2 mm

16 cm – 6¼"	RU 7865-16
20 cm – 8"	RU 7865-20

JANSSEN

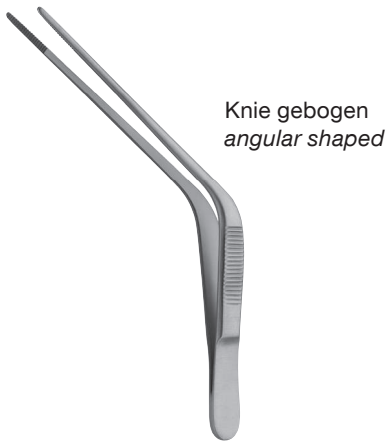

TROELTSCH (WILDE)

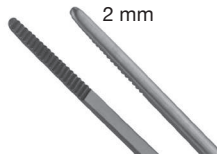

10,5 cm – 4¼"	RU 7860-11
11,5 cm – 4½"	RU 7860-12
15 cm – 6"	RU 7860-15
18 cm – 7"	RU 7860-18

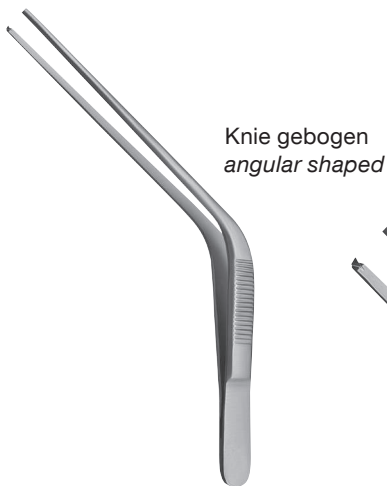

TROELTSCH

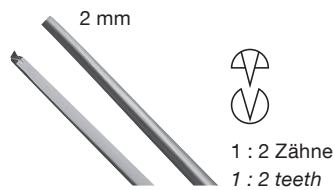

12 cm – 4¾"
RU 7861-12

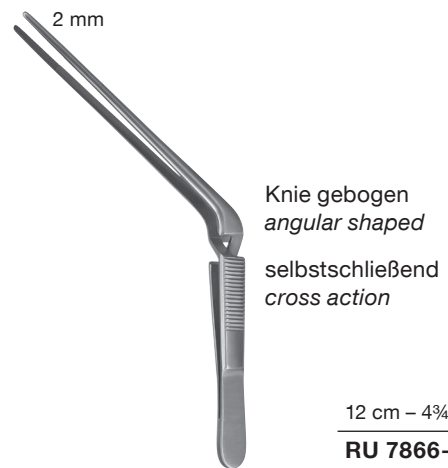

TROELTSCH

12 cm – 4¾"
RU 7866-12

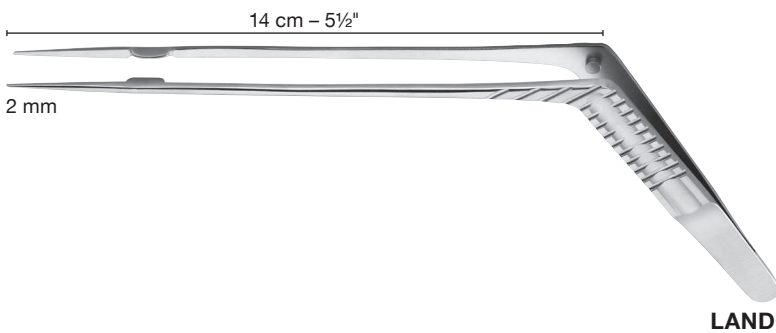

LANDOLT

21,5 cm – 8½"
RU 4095-00

Feine chirurgische Pinzetten Delicate Tissue Forceps



1 : 2 Zähne
1 : 2 teeth

gerade <i>straight</i>	leicht gebogen <i>slightly curved</i>	stark gebogen <i>strongly curved</i>
sehr fein <i>very delicate</i>	sehr fein <i>very delicate</i>	sehr fein <i>very delicate</i>
10 cm – 4"		
RU 4260-10	RU 4261-10	RU 4262-10

1 : 2 Zähne
1 : 2 teeth

gerade, kreuzgerieft <i>straight, cross serrated</i>	1 mm	gerade <i>straight</i>	
12 cm – 4¾"			
RU 4133-01	RU 4133-02	RU 4133-03	RU 4133-04

ADSON

1 : 2 Zähne
1 : 2 teeth

1 : 2 Zähne
1 : 2 teeth

15 cm – 6"	gerade <i>straight</i>	gerade <i>straight</i>
RU 4133-10	12 cm – 4¾" RU 4130-12	TC RU 4130-22
	15 cm – 6" RU 4130-15	TC RU 4130-25

ADSON **MICRO ADSON**

Feine chirurgische Pinzetten Delicate Tissue Forceps

1 : 2 Zähne
1 : 2 teeth



1 mm

kniegebogen
curved

12 cm – 4¾"

RU 4135-72

STANDARD ADSON



1 : 2 Zähne
1 : 2 teeth



1,5 mm
kreuzgerieft
cross serrated

12 cm – 4¾"

RU 4136-12

ADSON



12 cm – 4¾"

15 cm – 6"

1,5 mm

1 : 2 Zähne
1 : 2 teeth

2 mm

2 : 3 Zähne
2 : 3 teeth

RU 4135-12

RU 4135-15

RU 4135-52

RU 4135-55

STANDARD ADSON



1 : 2 Zähne
1 : 2 teeth



2 mm

12 cm – 4¾"

RU 4132-12

ADSON-EWALD



1 : 2 Zähne
1 : 2 teeth



1,5 mm

Typ
Type

gerade
straight

12 cm – 4¾"

15 cm – 6"

TC

RU 4134-12

TC

RU 4134-15

STANDARD ADSON

Feine chirurgische Pinzetten Delicate Tissue Forceps

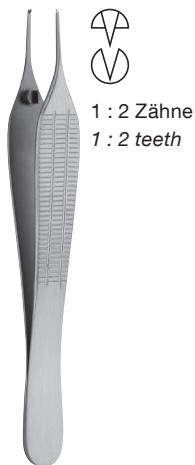

1 : 2 Zähne
1 : 2 teeth



0,8 mm

Zähne schräggestellt
Teeth in oblique position

12 cm – 4¾"

RU 4131-12

MICRO-ADSON-BIEMER



1 : 2 Zähne
1 : 2 teeth



1 mm

Zähne schräggestellt
Teeth in oblique position
Standard
Standard

kreuzgerieft
cross serrated

12 cm – 4¾"

RU 4136-72

ADSON



1 : 2 Zähne
1 : 2 teeth



1 mm

12 cm – 4¾"

RU 4135-82

ADSON



1 : 2 Zähne
1 : 2 teeth



0,6 mm

gerade
straight



0,8 mm

gerade
straight



1 mm

gerade
straight

15 cm – 6"

RU 4147-01

RU 4147-02

RU 4147-03

Feine chirurgische Pinzetten Delicate Tissue Forceps

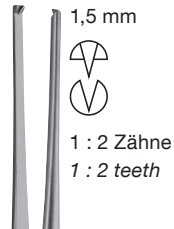

SEMKEN



SEMKEN

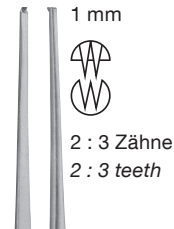

MICRO-SEMKEN

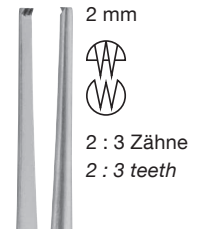

MICRO-SEMKEN

12,5 cm – 5"	RU 4140-12	RU 4141-12	RU 4140-30	RU 4142-12
15 cm – 6"	RU 4140-15	RU 4141-15	RU 4140-31	RU 4142-15

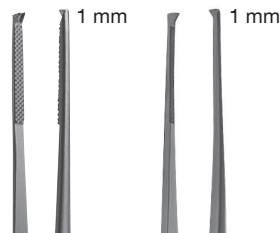

Typ
Type gerade
straight gerade
straight

14,5 cm – 5"	TC	RU 4140-24	–
16 cm – 6¼"	TC	–	RU 4140-26
18 cm – 7"	TC	RU 4140-28	–

MICRO-SEMKEN

Feine chirurgische Pinzetten Delicate Tissue Forceps



1 : 2 Zähne
1 : 2 teeth



gerade
straight

Typ / Type	15,5 cm – 6"
	RU 4138-15
TI	RU 4138-15T

GILLIES



1 : 2 Zähne
1 : 2 teeth



gerade
straight

Typ / Type	15,5 cm – 6"
	RU 4138-65
TC	

GILLIES



1 : 2 Zähne
1 : 2 teeth



gerade
straight

	15 cm – 6"
	RU 4138-75

MC INDOE



1 : 2 Zähne
1 : 2 teeth



gerade
straight

	17,5 cm – 7"
	RU 4148-18

BRAIN

Feine chirurgische Pinzetten Delicate Tissue Forceps

1 : 2 Zähne
1 : 2 teeth



1,5 mm

Typ
Type

gerade
straight

14,5 cm – 5¾"	TC	RU 4101-14
16 cm – 6¼"	TC	RU 4101-16
18 cm – 7"	TC	RU 4101-18
20 cm – 8"	TC	RU 4101-20
25 cm – 10"	TC	RU 4101-25
30 cm – 11¾"	TC	RU 4101-30

OEHLER



1 : 2 Zähne
1 : 2 teeth



1,5 mm

gerade
straight

15 cm – 6"	RU 4155-15
18 cm – 7"	RU 4155-18
20 cm – 8"	RU 4155-20
25 cm – 10"	RU 4155-25
30 cm – 11¾"	RU 4155-30

WAUGH



1 : 2 Zähne
1 : 2 teeth

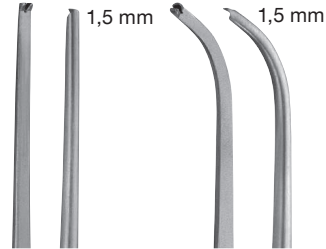

1,5 mm 1,5 mm

gerade
straight

gebogen
curved

18 cm – 7"	RU 4190-18	RU 4191-18
21 cm – 8¼"	RU 4190-21	RU 4191-21
25 cm – 10"	RU 4190-25	RU 4191-25

POTTS-SMITH



1 : 2 Zähne
1 : 2 teeth

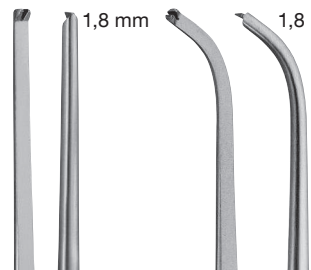

1,8 mm 1,8 mm

gerade
straight

gebogen
curved

18 cm – 7"	
RU 4180-17	RU 4181-17

CUSHING

Feine chirurgische Pinzetten Delicate Tissue Forceps

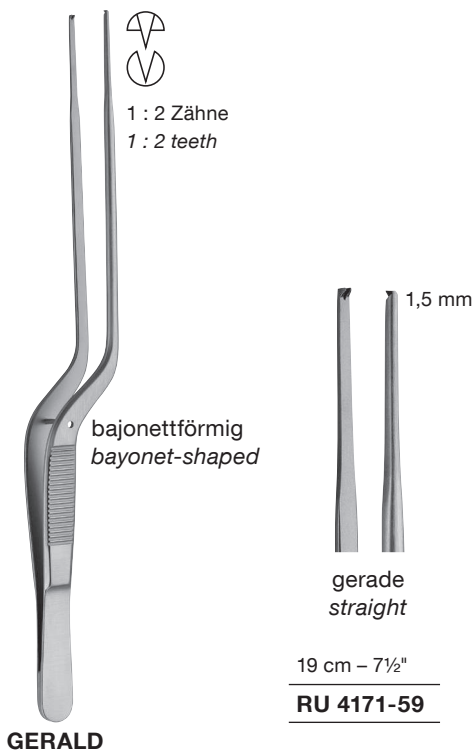
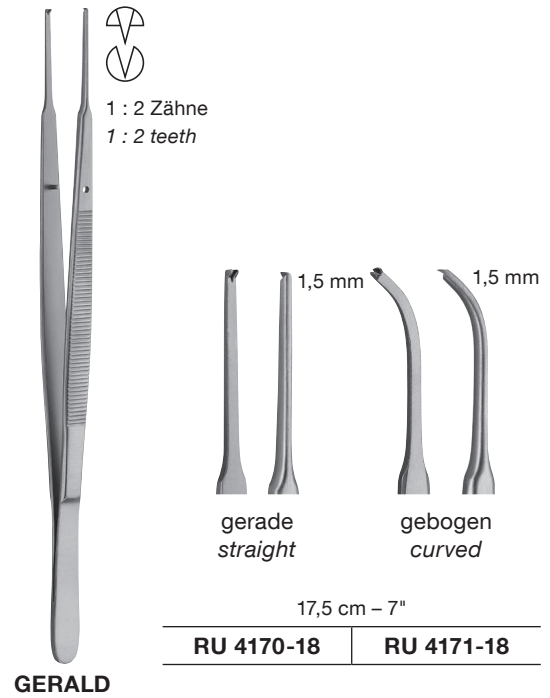
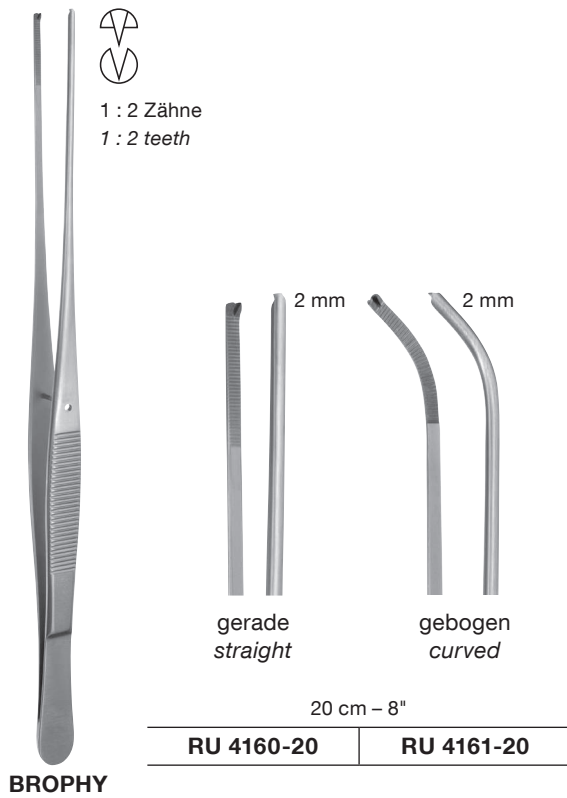

Feine chirurgische Pinzetten

Delicate Tissue Forceps

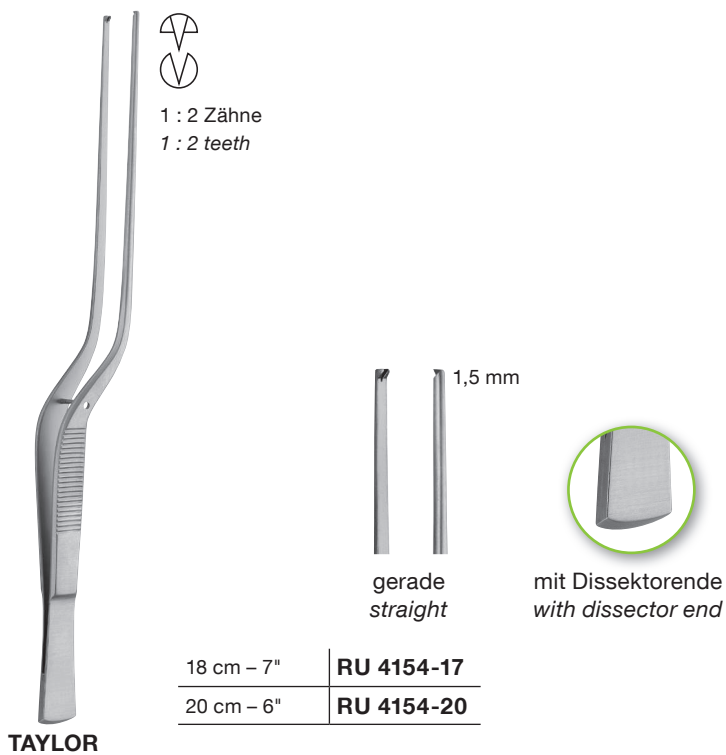
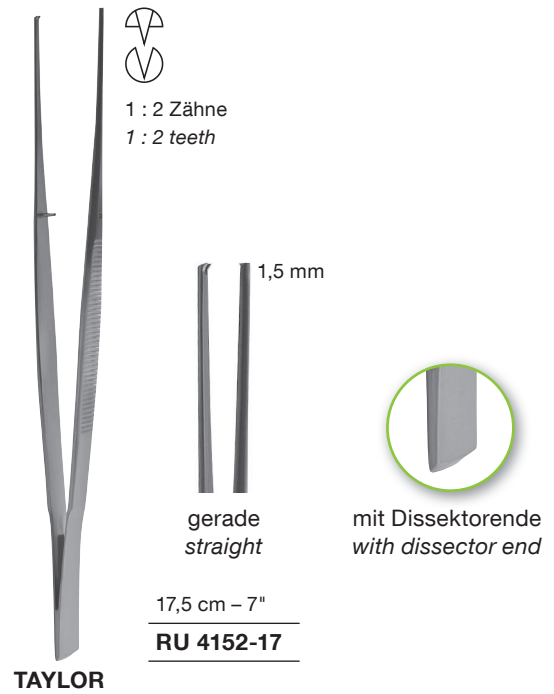
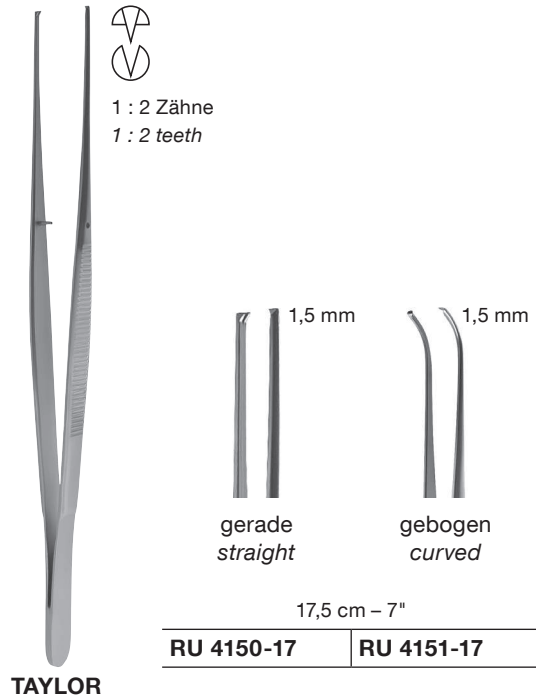

Chirurgische Pinzetten

Tissue Forceps



1 : 2 Zähne
1 : 2 teeth

Standard Modell
Standard pattern



gerade
straight

10,5 cm – 4¼"	RU 4100-10
11,5 cm – 4½"	RU 4100-11
13 cm – 5"	RU 4100-13
14,5 cm – 5¾"	RU 4100-14
15,5 cm – 6"	RU 4100-15
16 cm – 6¼"	RU 4100-16
18 cm – 7"	RU 4100-18
20 cm – 8"	RU 4100-20
25 cm – 10"	RU 4100-25
30 cm – 11¾"	RU 4100-30



1 : 2 Zähne
1 : 2 teeth

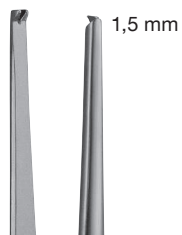

mittelbreit, gerade
medium, straight



mittelbreit, gebogen
medium, curved

11,5 cm – 4½"	RU 4110-11	–
13 cm – 5"	RU 4110-13	–
14,5 cm – 5¾"	RU 4110-14	RU 4111-14
15,5 cm – 6"	–	–
16 cm – 6¼"	RU 4110-16	–
18,5 cm – 7¼"	RU 4110-18	–
20 cm – 8"	RU 4110-20	–
25 cm – 10"	RU 4110-25	–



1 : 2 Zähne
1 : 2 teeth



gerade
straight

16 cm – 6¼"

RU 4109-16

Chirurgische Pinzetten

Tissue Forceps



Standard Modell
Standard pattern

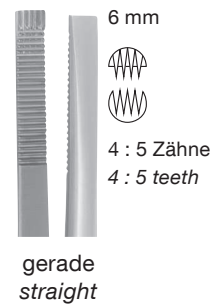
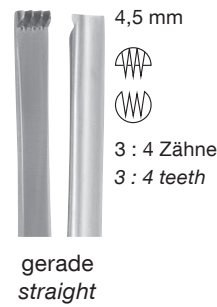
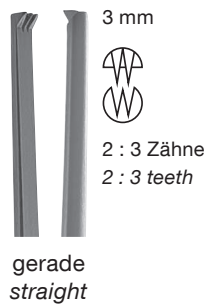

11,5 cm – 4½"	–	RU 4103-13	–
13 cm – 5"	RU 4102-13	RU 4103-14	RU 4104-13
14,5 cm – 5¾"	RU 4102-14	–	RU 4104-14
15,5 cm – 6"	–	RU 4103-16	–
16 cm – 6¼"	RU 4102-16	–	RU 4104-16
18 cm – 7"	RU 4102-18	–	–
20 cm – 8"	RU 4102-20	RU 4103-20	–
25 cm – 10"	RU 4102-25	–	–
30 cm – 11¾"	RU 4102-30	–	–



MODELL USA
USA PATTERN

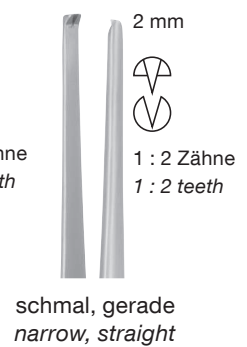
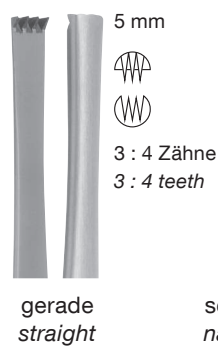
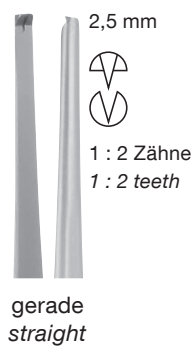

12 cm – 4¾"	RU 4120-12	RU 4122-12	–	–
13 cm – 5"	RU 4120-13	RU 4122-13	–	RU 4126-13
14,5 cm – 5¾"	RU 4120-14	RU 4122-14	RU 4123-14	RU 4126-14
15,5 cm – 6"	RU 4120-15	–	–	RU 4126-15
18,5 cm – 7¼"	RU 4120-18	RU 4122-18	–	–
21 cm – 8¼"	RU 4120-21	RU 4122-21	–	–
25 cm – 10"	RU 4120-25	RU 4122-25	–	–
31 cm – 12¼"	RU 4120-31	RU 4122-31	–	–

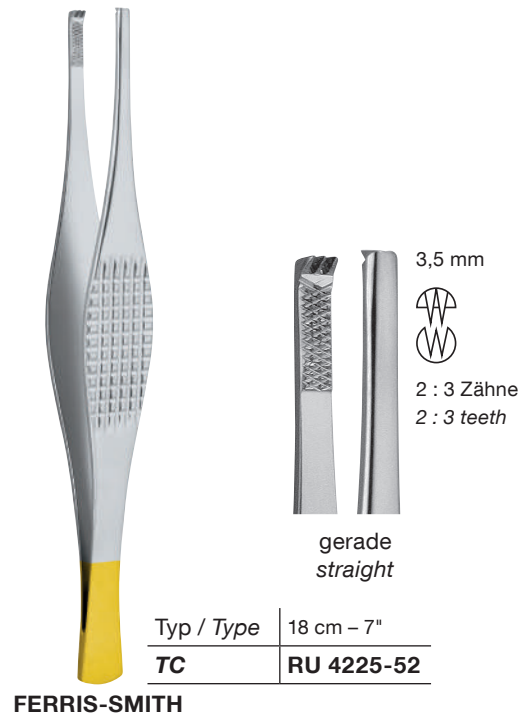
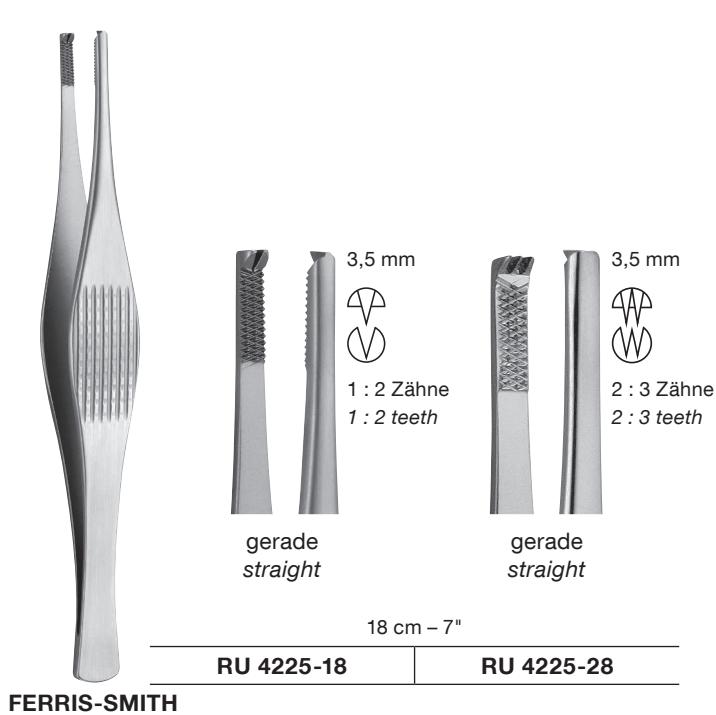
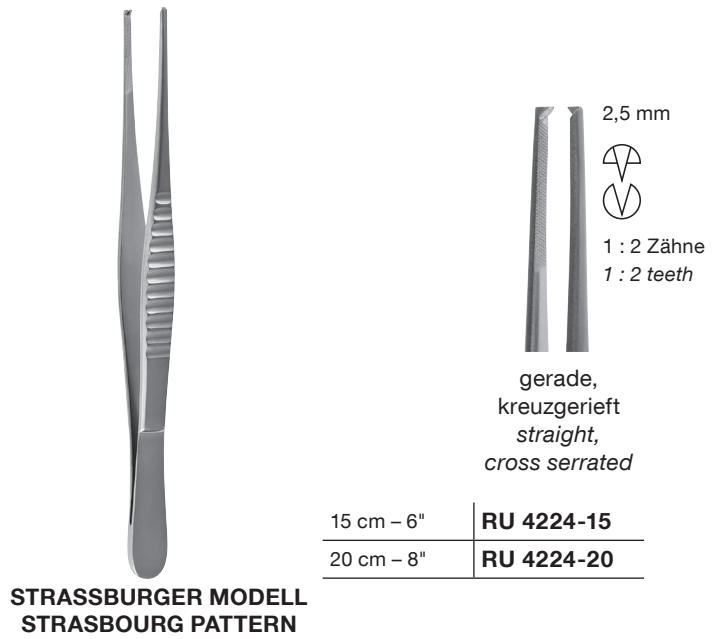
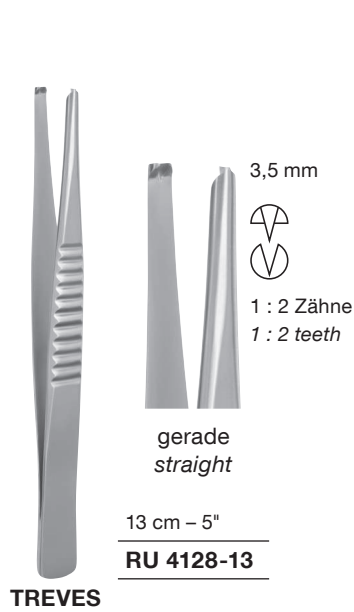

Chirurgische Pinzetten Tissue Forceps



LANE

	 4 mm 1 : 2 Zähne 1 : 2 teeth gerade straight	 4,5 mm 2 : 3 Zähne 2 : 3 teeth gerade straight
14,5 cm – 5¾"	RU 4226-14	RU 4227-14
20 cm – 8"	RU 4226-20	RU 4227-20



STILLE-BARRAYA

	 3 mm 3 : 4 Zähne 3 : 4 teeth gerade, kreuzgerieft straight, cross serrated
18 cm – 7"	RU 4228-18
20 cm – 8"	RU 4228-20
25 cm – 10"	RU 4228-25



BONNEY

	 4 mm 1 : 2 Zähne 1 : 2 teeth	 4 mm 2 : 3 Zähne 2 : 3 teeth
17 cm – 6¾"	RU 4229-18	RU 4230-18

	 2,5 mm 2 : 3 Zähne 2 : 3 teeth gerade straight	 4,0 mm 4 : 5 Zähne 4 : 5 teeth gerade straight
--	--	--

15 cm – 6"	RU 4144-15	RU 4145-15
20 cm – 8"	RU 4144-20	RU 4145-20
25 cm – 10"	RU 4144-25	RU 4145-25

NEW ORLEANS

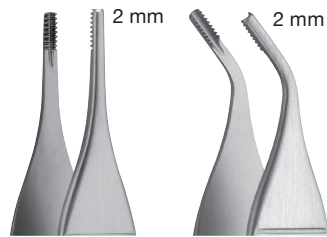

gerade
straight

gebogen
curved

12 cm – 4¾"	RU 4137-12	RU 4137-72
15 cm – 6"	RU 4137-15	–

ADSON-BROWN



gerade
straight

Typ / Type	12 cm – 4¾"
TC	RU 4137-62

ADSON-BROWN



gerade
straight

15 cm – 6"	RU 4026-15
------------	-------------------

COTTLE



gerade
straight

15 cm – 6"	RU 4139-15
20 cm – 6"	RU 4139-20
25 cm – 10"	RU 4139-25

BROWN



gerade
straight

12 cm – 4¾"	RU 4137-82
-------------	-------------------

ADSON-GRAEFER

Darm- und Lungenpinzetten Intestinal and Lung Forceps

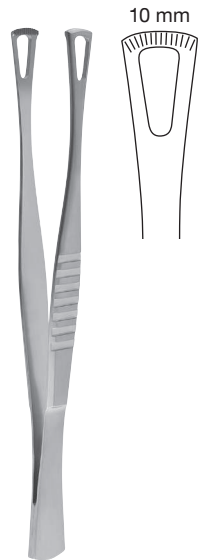

DUVAL

gerade
straight

14,5 cm – 5¾"
RU 4215-14

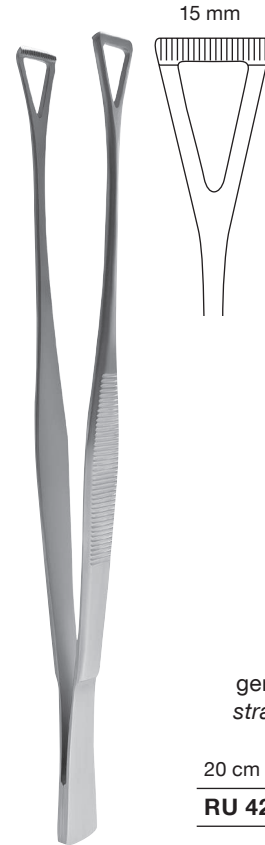

COLLIN-DUVAL

gerade
straight

20 cm – 8"
RU 4216-20



NELSON



gerade
straight

15 cm – 6"	RU 4235-15
18 cm – 7"	RU 4235-18
23 cm – 9"	RU 4235-23



SINGLEY-TUTTLE

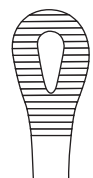

gerade
straight

18 cm – 7"	RU 4236-18
23 cm – 9"	RU 4236-23

Fasspinzetten Grasping Forceps



DURANTE



gerade
straight

14,5 cm – 5¾"	RU 4219-14
16 cm – 6¼"	RU 4219-16
20 cm – 8"	RU 4219-20



**RUSSISCHES MODELL
RUSSIAN PATTERN**



gerade
straight

15 cm – 6"	RU 4220-15
20 cm – 8"	RU 4220-20
25 cm – 10"	RU 4220-25



MAYO



gerade
straight

23 cm – 9"	RU 4221-23
------------	-------------------

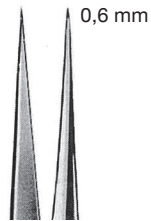

gerade, glatt
straight, smooth



gebogen, glatt
curved, smooth

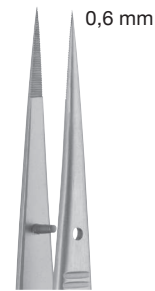

gerade
straight



gebogen
curved

8 cm – 3¼"	RU 4290-08	RU 4291-08	RU 4292-08	RU 4293-08
9 cm – 3½"	RU 4290-09	RU 4291-09	RU 4292-09	RU 4293-09
10,5 cm – 4¼"	RU 4290-10	RU 4291-10	RU 4292-10	RU 4293-10
11,5 cm – 4½"	RU 4290-11	RU 4291-11	RU 4292-11	RU 4293-11
12,5 cm – 5"	RU 4290-12	RU 4291-12	RU 4292-12	RU 4293-12
14,5 cm – 5¾"	–	–	RU 4270-05	RU 4270-15



FEILCHENFELD



gerade
straight

7,5 cm – 3"	RU 4320-07
9 cm – 3½"	RU 4320-09
11,5 cm – 4½"	RU 4320-11



HUNTER



gerade
straight



gebogen
curved

10,5 cm – 4¼"

RU 4340-10	RU 4341-10
-------------------	-------------------



WALTER-CARMALT



gerade
straight



gebogen
curved

10,5 cm – 4¼"

RU 4350-10	RU 4351-10
-------------------	-------------------

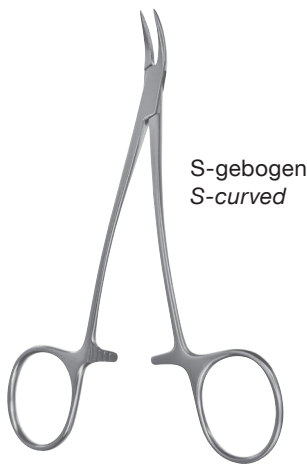

S-gebogen
S-curved

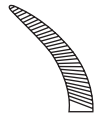

11 cm – 4¼"

RU 4358-11

PEET



STIEGLITZ



gerade,
ohne Sperre
straight,
without ratchet

gerade,
mit Sperre
straight,
with ratchet



gebogen,
ohne Sperre
curved,
without ratchet

gebogen,
mit Sperre
curved,
with ratchet

13,5 cm – 5¼"

RU 4359-13

RU 4360-13

RU 4362-13

RU 4361-13



RALK

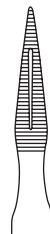

gerade
straight

15 cm – 6"

RU 4364-15



RALK

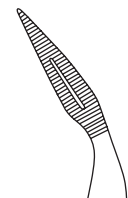

abgewinkelt 45°
angled 45°

15 cm – 6"

RU 4365-15

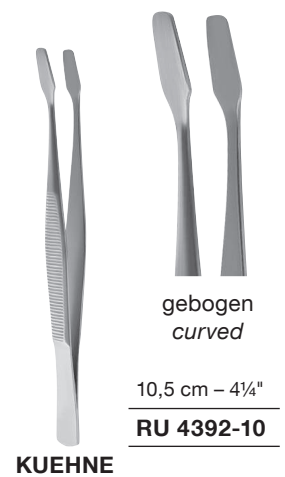
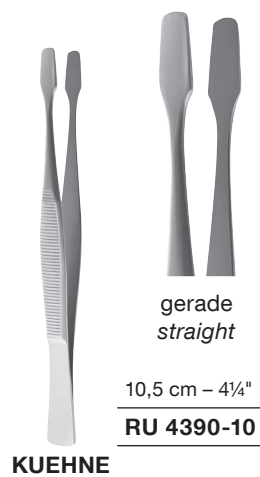
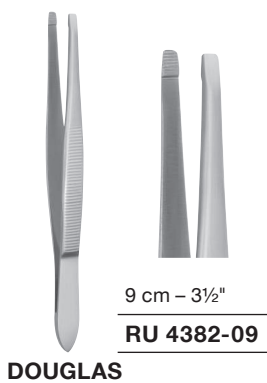
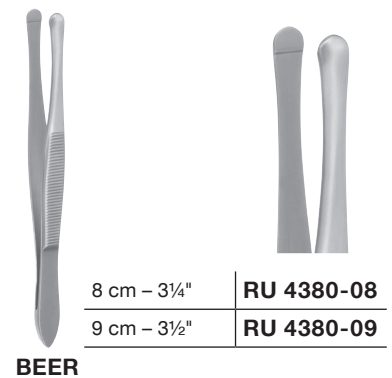
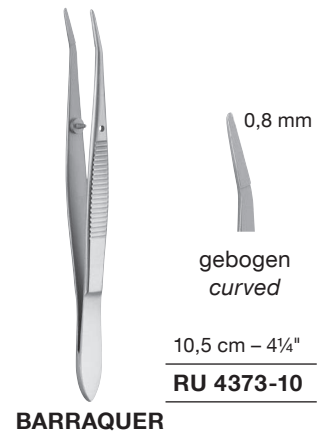
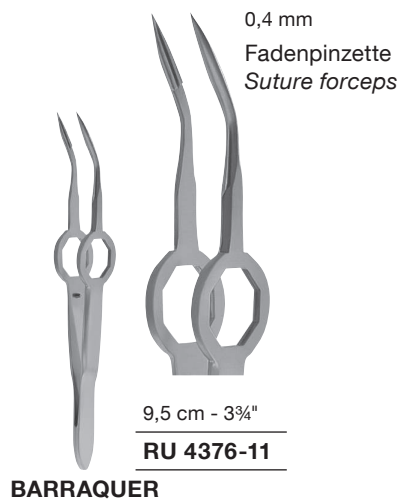

Cilienpinzetten Cilia Forceps





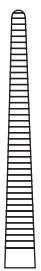
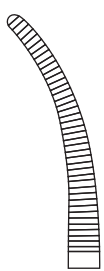

Arterienklemmen	<i>Hemostatic forceps</i>	CF 1 - 25
Ligaturklemmen	<i>Ligature Forceps</i>	CF 26 - 39
Klemmzangen	<i>Clamp Forceps</i>	CF 40 - 41
Peritoneumklemmen	<i>Peritoneal Forceps</i>	CF 42 - 44
Tuchklemmen	<i>Towel Forceps</i>	CF 45 - 48
Schlauchklemmen	<i>Tubing Forceps</i>	CF 49 - 50
Kornzangen	<i>Dressing Forceps</i>	CF 51 - 53
Tupferzangen	<i>Cotton Swab Forceps</i>	CF 54 - 55
Schwammzangen	<i>Sponge Holding Forceps</i>	CF 56 - 57
Bulldogklemmen	<i>Bulldog Clamps</i>	CF 58 - 61

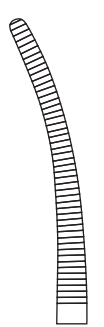

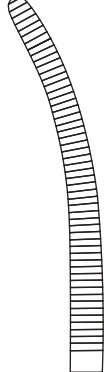

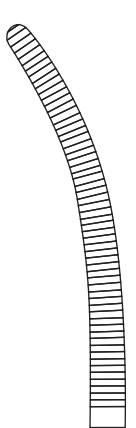
			
gerade straight	gebogen curved	gerade straight	gebogen curved
13 cm – 5"		14 cm – 5½"	
RU 3000-13	RU 3001-13	RU 3000-14	RU 3001-14

			
gerade straight	gebogen curved	gerade straight	gebogen curved
16 cm – 6¼"		18 cm – 7"	
RU 3000-16	RU 3001-16	RU 3000-18	RU 3001-18

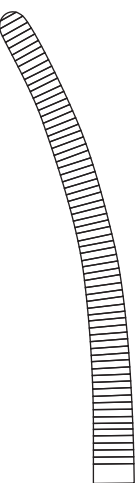

ROCHESTER-PEAN

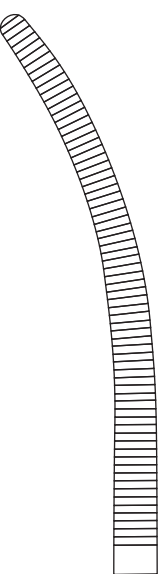
			
gerade straight	gebogen curved	gerade straight	gebogen curved
20 cm – 8"		22 cm – 8¾"	
RU 3000-20	RU 3001-20	RU 3000-22	RU 3001-22



ROCHESTER-PEAN

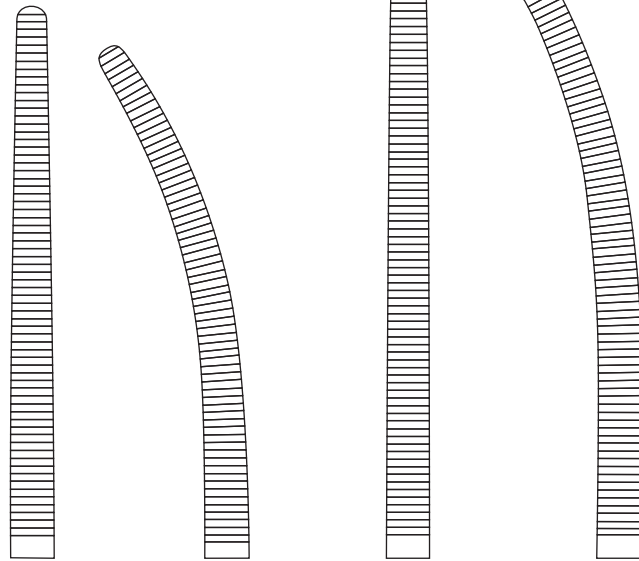

gerade <i>straight</i>	gebogen <i>curved</i>	gerade <i>straight</i>	gebogen <i>curved</i>
24 cm – 9½"		26 cm – 10¼"	
RU 3000-24	RU 3001-24	RU 3000-26	RU 3001-26



ROCHESTER-PEAN

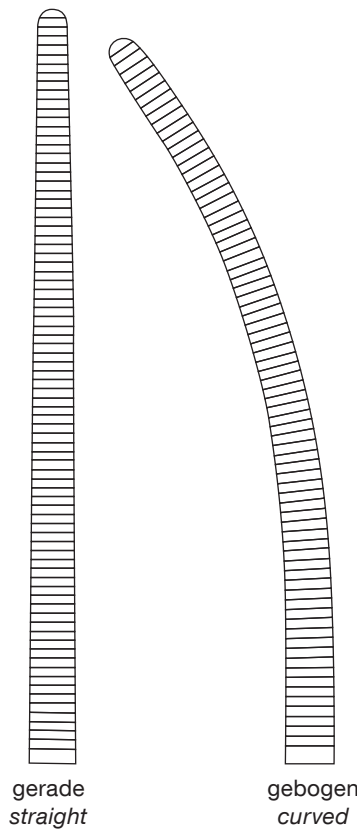

gerade <i>straight</i>	gebogen <i>curved</i>
30 cm – 11¾"	
RU 3000-30	RU 3001-30



gerade
straight



gebogen
curved



gerade
straight



gebogen
curved

13 cm – 5"

RU 3010-13

RU 3011-13

14 cm – 5½"

RU 3010-14

RU 3011-14



1 : 2 Zähne
1 : 2 teeth

OCHSNER-KOCHER



gerade
straight



gebogen
curved

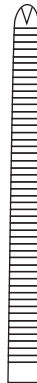

gerade
straight

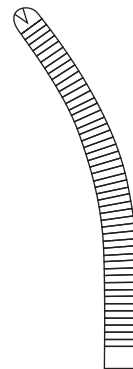

gebogen
curved

16 cm – 6¼"

RU 3010-16

RU 3011-16

18 cm – 7"

RU 3010-18

RU 3011-18

Arterienklemmen Hemostatic Forceps



1 : 2 Zähne
1 : 2 teeth

OCHSNER-KOCHER



gerade
straight

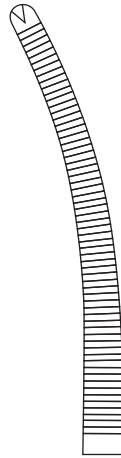

gebogen
curved



gerade
straight

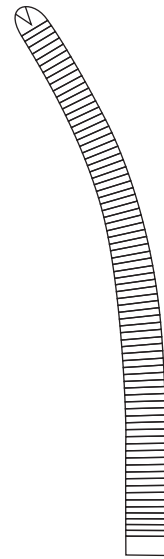

gebogen
curved

20 cm – 8"

22 cm – 8¾"

RU 3010-20

RU 3011-20

RU 3010-22

RU 3011-22



1 : 2 Zähne
1 : 2 teeth

OCHSNER-KOCHER



gerade
straight

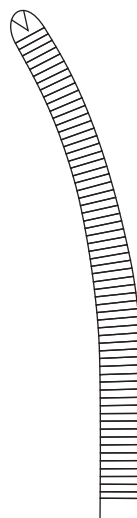

gebogen
curved



gerade
straight

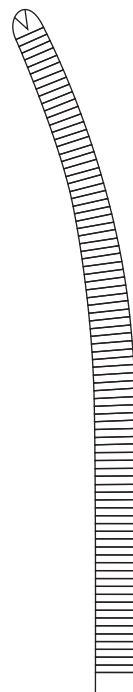

gebogen
curved

24 cm – 9½"

26 cm – 10¼"

RU 3010-24

RU 3011-24

RU 3010-26

RU 3011-26



1 : 2 Zähne
1 : 2 teeth

OCHSNER-KOCHER



gerade
straight

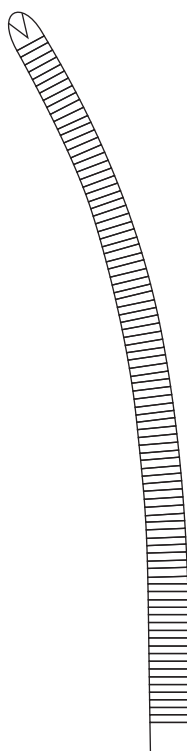

gebogen
curved





30 cm – 11 $\frac{3}{4}$ "

RU 3010-30	RU 3011-30
-------------------	-------------------

Arterienklemmen Hemostatic Forceps





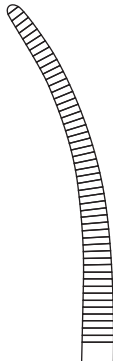



PEAN

					
gerade straight	gebogen curved	gerade straight	gebogen curved	gerade straight	gebogen curved
13 cm – 5"		14 cm – 5½"		16 cm – 6¼"	
RU 3020-13	RU 3021-13	RU 3020-14	RU 3021-14	RU 3020-16	RU 3021-16



KOCHER

 1 : 2 Zähne
 1 : 2 teeth

					
gerade straight	gebogen curved	gerade straight	gebogen curved	gerade straight	gebogen curved
13 cm – 5"		14 cm – 5½"		16 cm – 6¼"	
RU 3030-13	RU 3031-13	RU 3030-14	RU 3031-14	RU 3030-16	RU 3031-16

Arterienklemmen Hemostatic Forceps



KELLY



gerade
straight



gebogen
curved

14,5 cm – 5¾"

RU 3050-14	RU 3051-14
-------------------	-------------------



KELLY-RANKIN



gerade
straight



gebogen
curved

16 cm – 6¼"

RU 3050-16	RU 3051-16
-------------------	-------------------



CRILE



gerade
straight



gebogen
curved



gerade
straight



1 : 2 Zähne
1 : 2 teeth



gebogen
curved



1 : 2 Zähne
1 : 2 teeth

14,5 cm – 5¾"

RU 3070-14	RU 3071-14	RU 3074-14	RU 3075-14
-------------------	-------------------	-------------------	-------------------



CRILE-RANKIN



gerade
straight

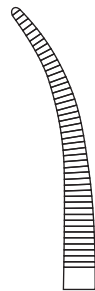

gebogen
curved



gerade
straight



1 : 2 Zähne
1 : 2 teeth

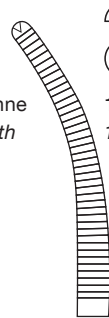

gebogen
curved



1 : 2 Zähne
1 : 2 teeth

16 cm – 6¼"

RU 3070-16	RU 3071-16	RU 3074-16	RU 3075-16
-------------------	-------------------	-------------------	-------------------



BABY-CRILE

gerade
straight



gebogen
curved

14,5 cm – 5¾"

RU 3072-14	RU 3073-14
-------------------	-------------------



BABY-CRILE



1 : 2 Zähne
1 : 2 teeth



gerade
straight



gebogen
curved

14,5 cm – 5¾"

RU 3076-14	RU 3077-14
-------------------	-------------------



COLLER-CRILE



gerade
straight



gebogen
curved



gerade
straight



gebogen
curved

14 cm – 5½"

RU 3078-14

RU 3079-14

16 cm – 6¼"

RU 3078-16

RU 3079-16



COLLER-CRILE

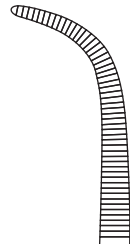

gebogen
curved

16 cm – 6¼"

RU 3979-36



LERICHE



gerade
straight

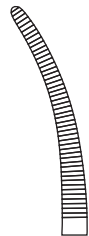

gebogen
curved

15 cm – 6"

RU 3080-15

RU 3081-15



LERICHE



1 : 2 Zähne
1 : 2 teeth



gerade
straight



gebogen
curved

15 cm – 6"

RU 3082-15

RU 3083-15



PROVIDENCE



gerade
straight



gebogen
curved

14,5 cm – 5¾"

RU 3090-14 | **RU 3091-14**



Ligaturklemme
Ligature forceps



gerade, glatt
straight, smooth

9,5 cm – 3¾"

RU 3097-09



HALSTED-MOSQUITO



gerade
straight



gebogen
curved

12,5 cm – 5"

RU 3100-12 | **RU 3101-12**



HALSTED-MOSQUITO



1 : 2 Zähne
1 : 2 teeth



gerade
straight



gebogen
curved

12,5 cm – 5"

RU 3110-12 | **RU 3111-12**



HALSTED-MOSQUITO



gerade
straight



gebogen
curved

14 cm – 5½"

RU 3100-14 | **RU 3101-14**



HALSTED-MOSQUITO



1 : 2 Zähne
1 : 2 teeth



gerade
straight



gebogen
curved

14 cm – 5½"

RU 3110-14 | **RU 3111-14**



HALSTED-MOSQUITO



gerade
straight



gebogen
curved

18 cm – 7"

RU 3100-18

RU 3101-18



gerade
straight



1 : 2 Zähne
1 : 2 teeth



gebogen
curved



1 : 2 Zähne
1 : 2 teeth

18 cm – 7"

RU 3110-18

RU 3111-18



HALSTED-MOSQUITO



gerade
straight

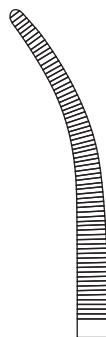

gebogen
curved

21 cm – 8¼"

RU 3100-21

RU 3101-21



gerade
straight



1 : 2 Zähne
1 : 2 teeth



gebogen
curved



1 : 2 Zähne
1 : 2 teeth

21 cm – 8¼"

RU 3110-21

RU 3111-21

Arterienklemmen Hemostatic Forceps



JACOBSON



gerade
straight



gebogen
curved

13 cm – 5"

RU 3114-13

RU 3115-13



MICRO-MOSQUITO



gerade
straight



gebogen
curved

10 cm – 4"

RU 3120-10

RU 3121-10



gerade
straight

1 : 2 Zähne
1 : 2 teeth

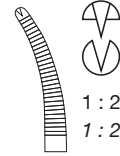

gebogen
curved

1 : 2 Zähne
1 : 2 teeth

10 cm – 4"

RU 3122-10

RU 3123-10



MICRO-MOSQUITO



gerade
straight



gebogen
curved

12,5 cm – 5"

RU 3120-12

RU 3121-12



gerade
straight

1 : 2 Zähne
1 : 2 teeth

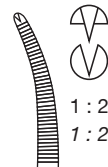

gebogen
curved

1 : 2 Zähne
1 : 2 teeth

12,5 cm – 5"

RU 3122-12

RU 3123-12

Arterienklemmen Hemostatic Forceps

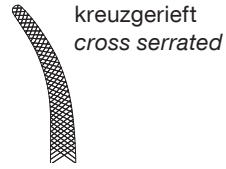

kreuzgerieft
cross serrated

gebogen
curved

12 cm – 4¾"

RU 3137-12



HARTMANN



gerade
straight



gebogen
curved

10 cm – 4"

RU 3140-10

RU 3141-10



gerade
straight

1 : 2 Zähne
1 : 2 teeth



gebogen
curved

1 : 2 Zähne
1 : 2 teeth

10 cm – 4"

RU 3142-10

RU 3143-10



CARREL



gerade
straight

10 cm – 4"

RU 3147-10



CHAPUT

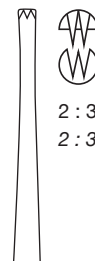

gerade
straight

2 : 3 Zähne
2 : 3 teeth

13 cm – 5"

RU 3148-13

Arterienklemmen Hemostatic Forceps



TUFFIER



gerade
straight

13 cm – 5"

RU 3149-13



PENNINGTON

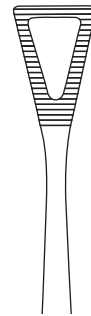

15 cm – 6"

RU 3152-15

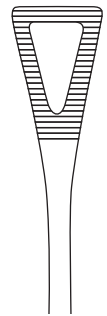

20 cm – 8"

RU 3152-20



PEAN

kurzfassende Maulteile
short gripping jaws



gerade
straight

14 cm – 5½"

RU 3153-14



gerade
straight

16 cm – 6¼"

RU 3153-16



COLLIN

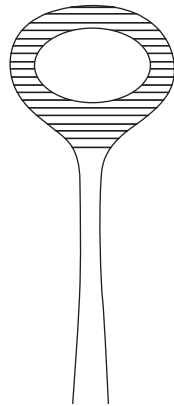

gerade
straight

15,5 cm – 6"

RU 3155-16



COLLIN

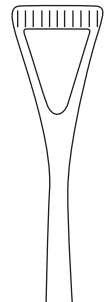

gerade
straight

14 cm – 5½"

RU 3156-14



COLLIN

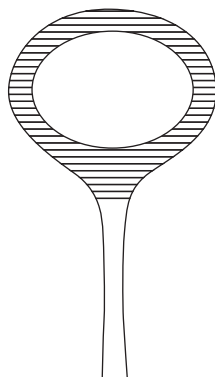

gerade
straight

16,5 cm – 6½"

RU 3157-16



DUNHILL



gebogen
curved

13 cm – 5"

RU 3159-13



CAIRNS



gerade
straight



gebogen
curved

15 cm – 6"

RU 3162-15 | **RU 3163-15**



MOYNIHAN



seitlich gebogen
curved sideways

13,5 cm – 5¼"

RU 3164-01



MOYNIHAN

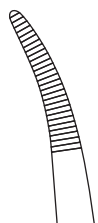

gebogen
curved

15 cm – 6"

RU 3164-02



seitlich gebogen
curved sideways

18 cm – 7"

RU 3165-18

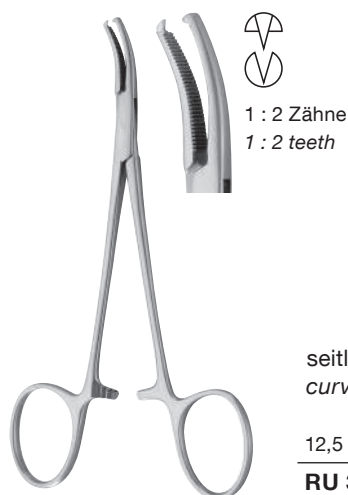

seitlich gebogen
curved sideways

12,5 cm – 5"

RU 3166-13

RAIMONDI



seitlich gebogen
curved sideways

14 cm – 5½"

RU 3167-13

HOEN

Arterienklemmen Hemostatic Forceps



ROCHESTER-CARMALT



gerade
straight



gebogen
curved



gerade
straight



gebogen
curved

16 cm – 6¼"

RU 3170-16

RU 3171-16

20 cm – 8"

RU 3170-20

RU 3171-20



MOSQUITO-DANDY



kreuzgerieft
cross serrated

seitlich gebogen
curved sideways

12 cm – 4¾"

RU 3179-12

RU 3181-12



DANDY



1 : 2 Zähne
1 : 2 teeth

seitlich gebogen
curved sideways

14 cm – 5½"

RU 3182-14

RU 3183-14

Arterienklemmen Hemostatic Forceps



1 : 2 Zähne
1 : 2 teeth

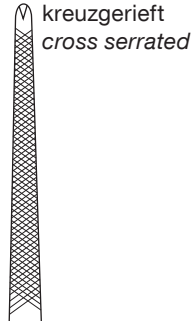

kreuzgerieft
cross serrated

gerade
straight

15,5 cm – 6"

RU 3185-15

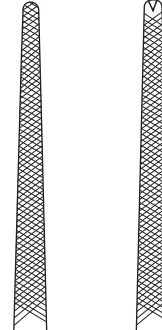

1 : 2 Zähne
1 : 2 teeth

gerade, kreuzgerieft
straight, cross serrated

16 cm – 6¼"

RU 3186-16

RU 3187-16

LOVELACE

DIXON-LOVELACE



gerade
straight

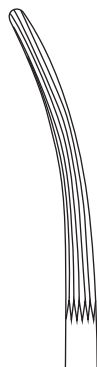

gebogen
curved



gerade
straight

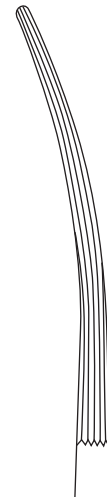

gebogen
curved

15 cm – 6"

RU 3190-15

RU 3191-15

18 cm – 7"

RU 3190-18

RU 3191-18

BAINBRIDGE



FUCHSIG



gebogen
curved

19 cm – 7½"

RU 3198-19



ADSON



gerade
straight

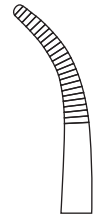

gebogen
curved

18,5 cm – 7¼"

RU 3200-18

RU 3201-18



NISSEN



gebogen
curved

18,5 cm – 7¼"

RU 3204-18



22 cm – 8¾"

RU 3204-22



BABY-ADSON

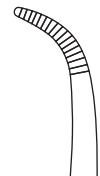

leicht gebogen
slightly curved

14 cm – 5½"

RU 3205-14

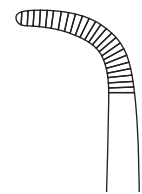

stark gebogen
strongly curved

18 cm – 7"

RU 3205-18



gerade
straight



gebogen
curved

20 cm – 8"

RU 3240-20

RU 3241-20



gerade
straight



gebogen
curved

22 cm – 8¾"

RU 3240-22

RU 3241-22



kreuzgerieft
cross serrated

BENGOLEA



gerade
straight



gebogen
curved

24 cm – 9½"

RU 3240-24

RU 3241-24



gerade
straight



gebogen
curved

26 cm – 10¼"

RU 3240-26

RU 3241-26

Arterienklemmen
Hemostatic Forceps



BIRKETT

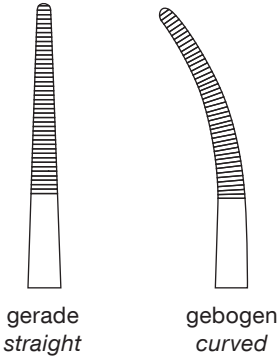

19 cm – 7½"

RU 3210-19	RU 3211-19
-------------------	-------------------



ROBERTS

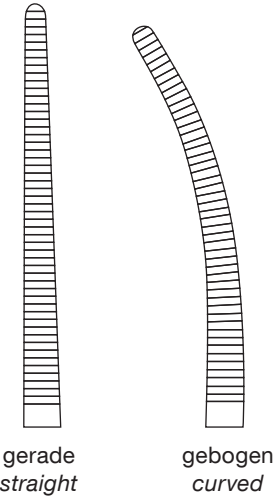

22 cm – 8¾"

RU 3250-22	RU 3251-22
-------------------	-------------------

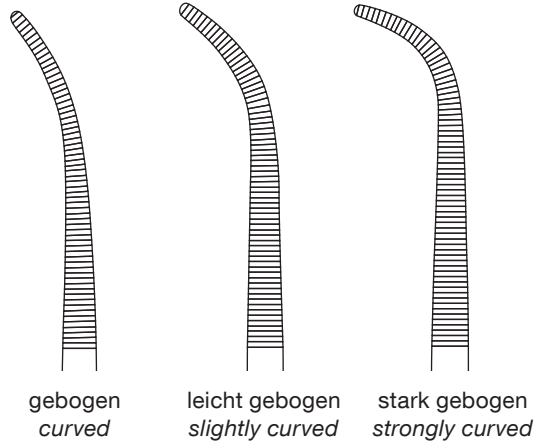

19 cm – 7½"

RU 3253-41	RU 3253-42	RU 3253-43
-------------------	-------------------	-------------------

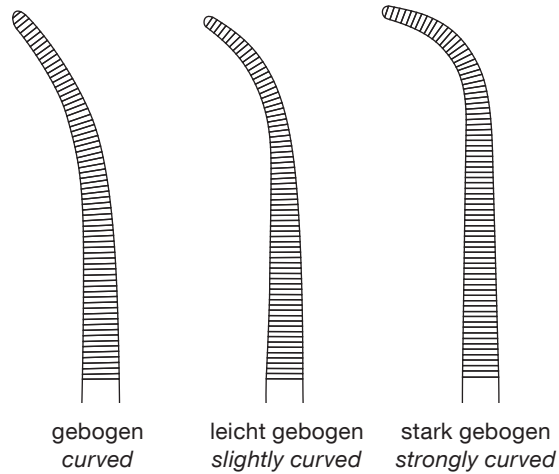

22 cm – 8¾"

RU 3253-61	RU 3253-62	RU 3253-63
-------------------	-------------------	-------------------

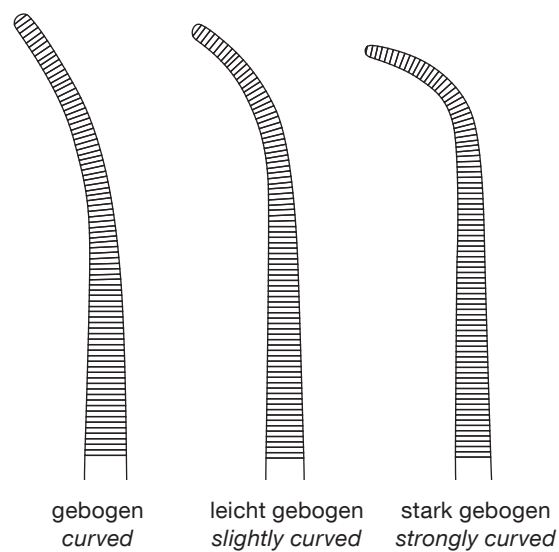

24 cm – 9½"

RU 3253-71	RU 3253-72	RU 3253-73
-------------------	-------------------	-------------------



KELLY



SAROT

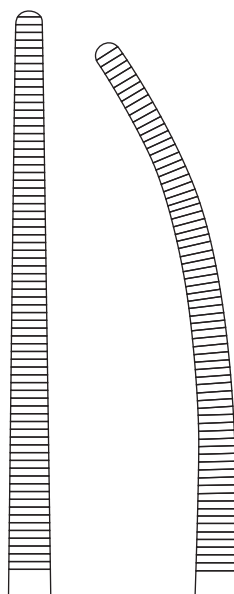

gerade
straight

gebogen
curved

24 cm – 9½"

RU 3270-24

RU 3271-24

Arterienklemmen Hemostatic Forceps



CRAFOORD

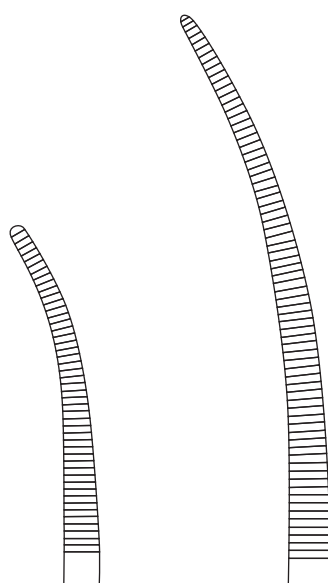

gebogen
curved

18 cm – 7"	24 cm – 9½"
RU 3275-18	RU 3275-24



Ligaturklemme
Ligature forceps

KANTROWITZ

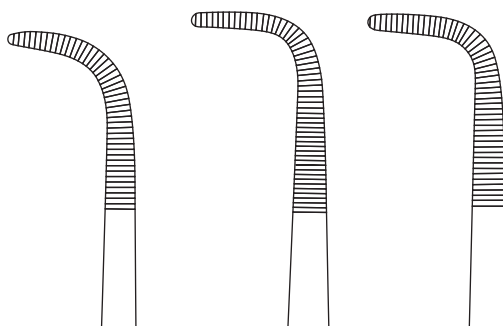

gebogen
curved

stark gebogen
strongly curved

stark gebogen
strongly curved

19 cm – 7½"	24 cm – 9½"	26,5 cm – 10½"
RU 3279-19	RU 3279-24	RU 3279-26



JOHNS-HOPKINS

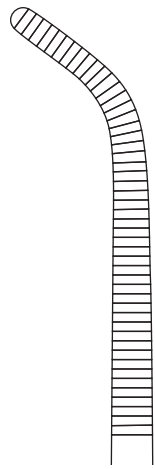

gebogen
curved

20 cm – 8"

RU 3285-20



RUMEL

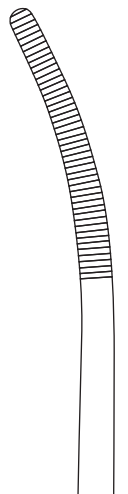

gebogen
curved

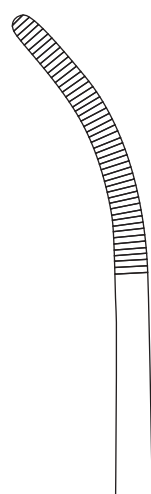

gebogen
curved

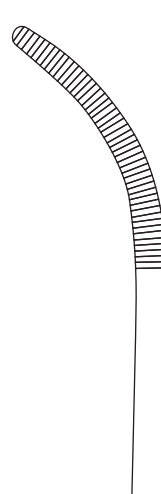

gebogen
curved

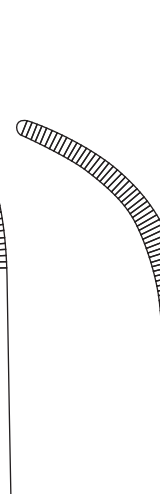

gebogen
curved

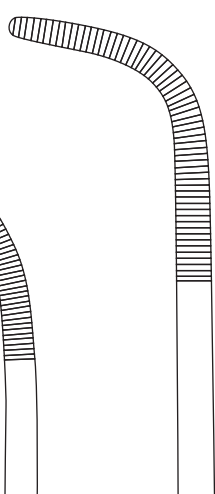

gebogen
curved

23 cm – 9"

RU 3280-01

RU 3280-02

RU 3280-03

RU 3280-04

RU 3280-05



ZENKER



gerade
straight

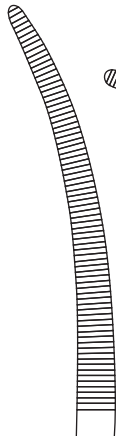

leicht gebogen
slightly curved

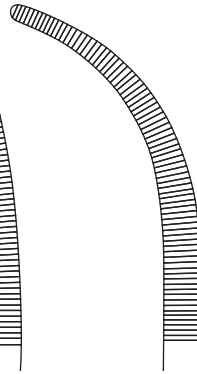

stark gebogen
strongly curved

29,5 cm – 11½"

RU 3286-00	RU 3286-01	RU 3286-02
-------------------	-------------------	-------------------



BABY-OVERHOLT

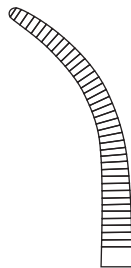

gebogen
curved

13,5 cm – 5¼"

RU 3289-14

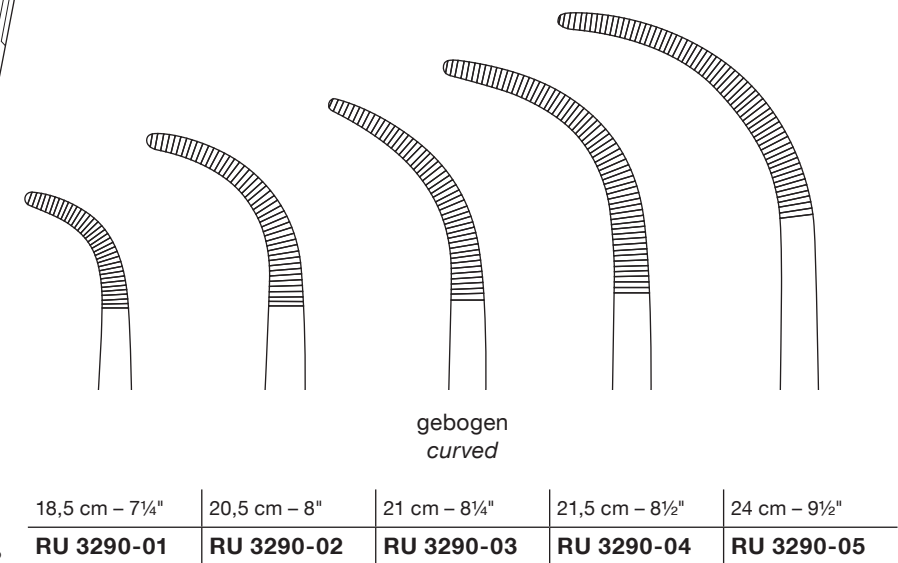
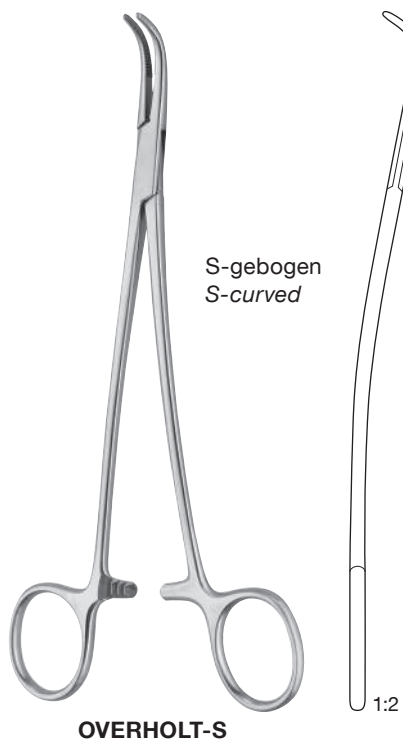
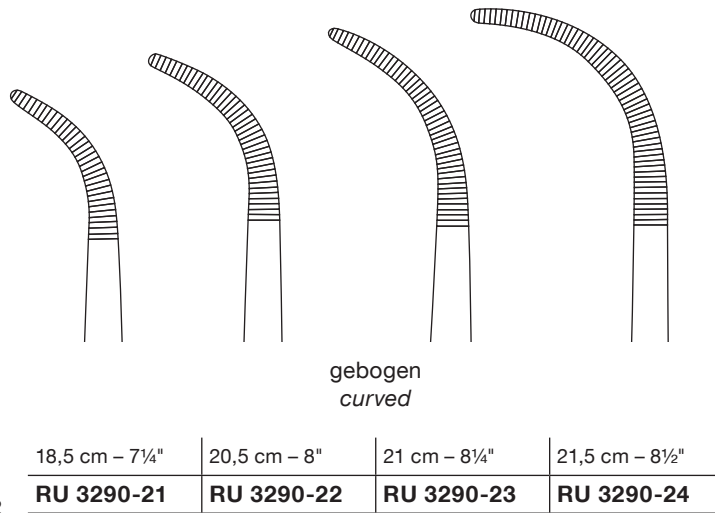
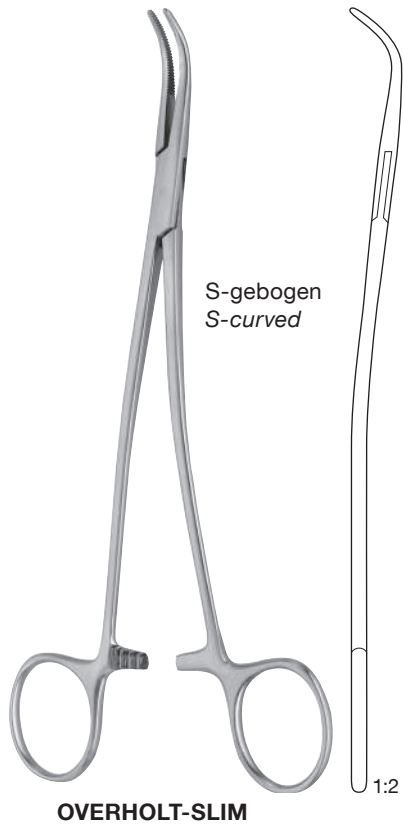



OVERHOLT-GEISSENDÖRFER

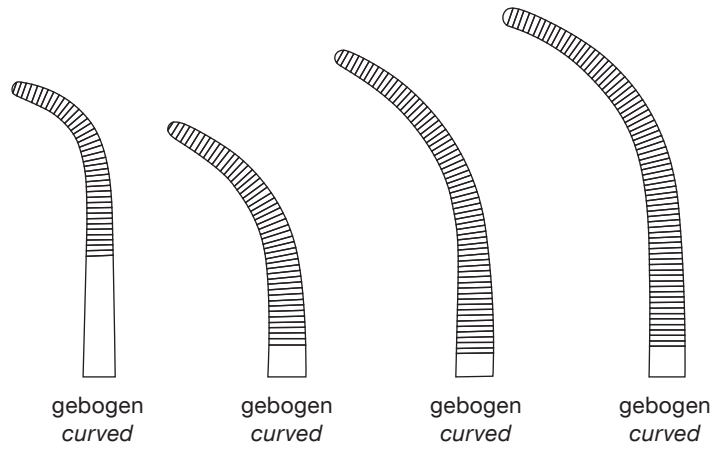

21 cm – 8¼"

RU 3291-21	RU 3292-21	RU 3293-21	RU 3294-21
-------------------	-------------------	-------------------	-------------------

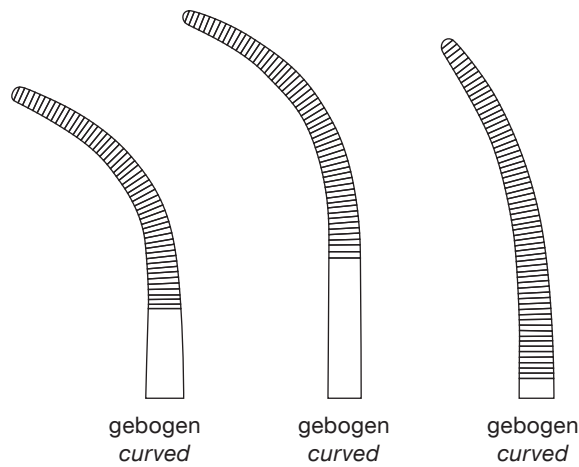

21 cm – 8¼"

RU 3295-21	RU 3296-21	RU 3297-21
-------------------	-------------------	-------------------



OVERHOLT-GEISSENDÖRFER

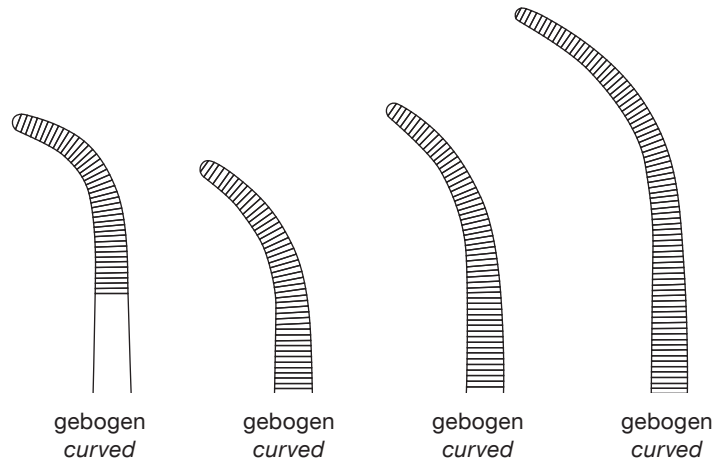

27 cm – 10½"

RU 3291-27	RU 3292-27	RU 3293-27	RU 3294-27
-------------------	-------------------	-------------------	-------------------

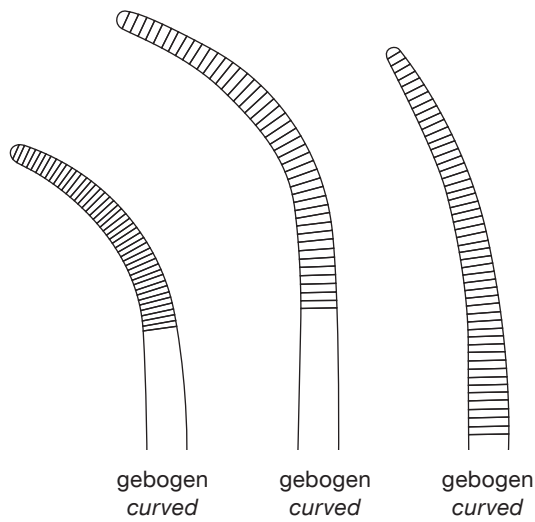

27 cm – 10½"

RU 3295-27	RU 3296-27	RU 3297-27
-------------------	-------------------	-------------------



OVERHOLT-MIXTER

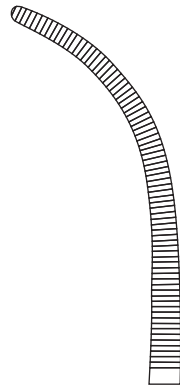

gebogen
curved

21 cm – 8¼"

RU 3298-21



HEISS



gerade
straight

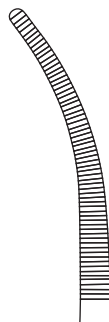

leicht gebogen
slightly curved

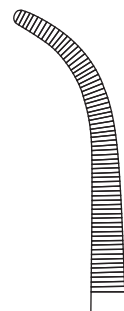

stark gebogen
strongly curved

20 cm – 8"

RU 3301-20

RU 3302-20

RU 3303-20



1 : 2 Zähne
1 : 2 teeth



gerade
straight

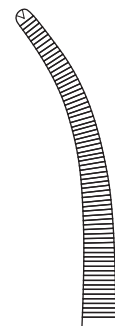

gebogen
curved

20 cm – 8"

RU 3305-20

RU 3306-20



MEEKER

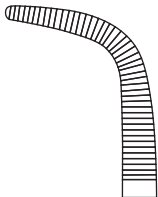

gebogen
curved

27 cm – 10½"

RU 3308-27



Gallenkanalklemme
Gall duct forceps

LOWER

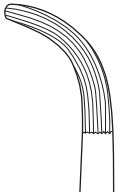

gebogen
curved

18 cm – 7"

RU 3325-18

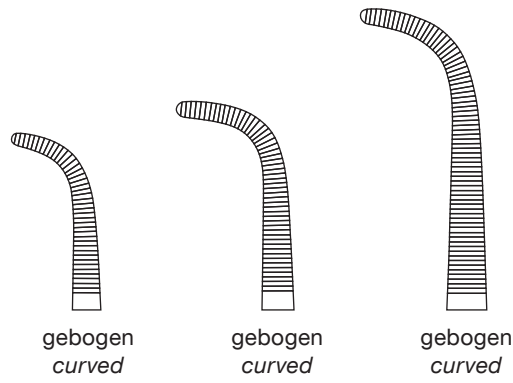

13 cm – 5"	18 cm – 7"	20 cm – 8"
RU 3326-13	RU 3326-18	RU 3326-20



GEMINI

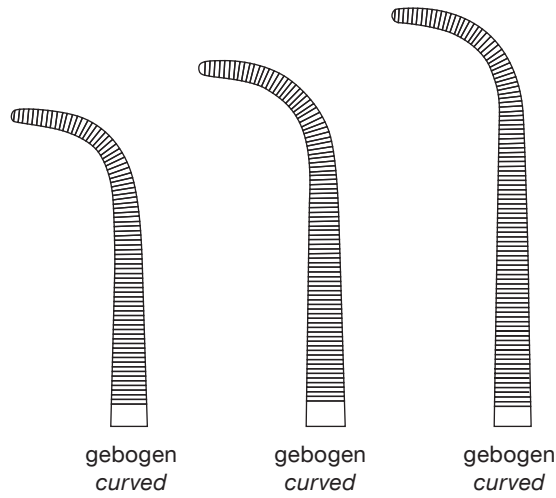

23 cm – 9"	25 cm – 10"	27 cm – 10½"
RU 3326-23	RU 3326-25	RU 3326-27



MINI-GEMINI

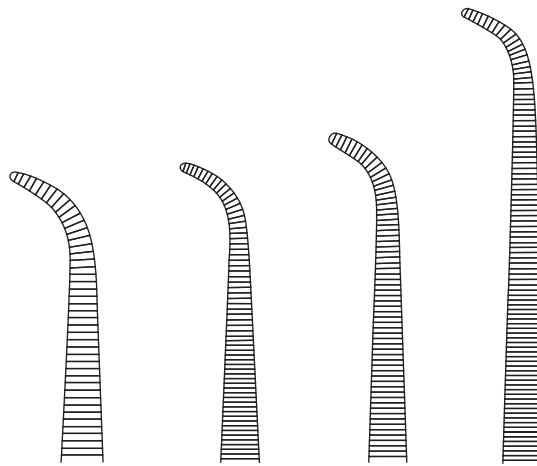

gebogen
curved

18 cm - 7"	22 cm - 8¾"	25 cm - 10"	28 cm - 11"
RU 3327-18	RU 3327-22	RU 3327-25	RU 3327-28



BABY-MIXTER

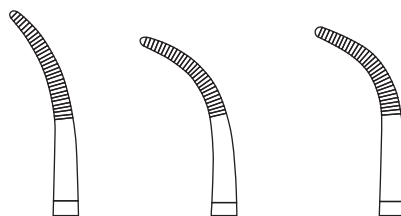

gebogen
curved

14 cm - 5½"	14 cm - 5½"	18 cm - 7"
RU 3328-01	RU 3328-14	RU 3328-18

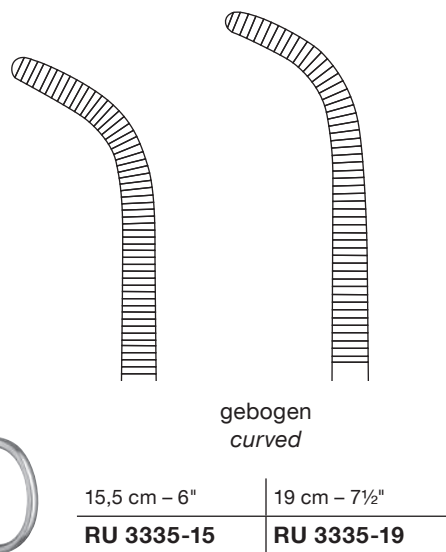
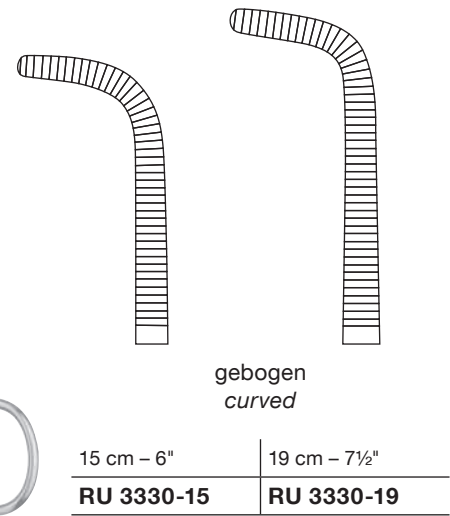
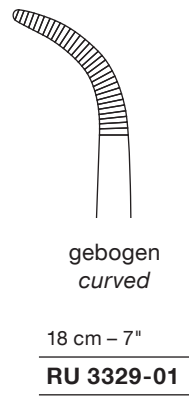
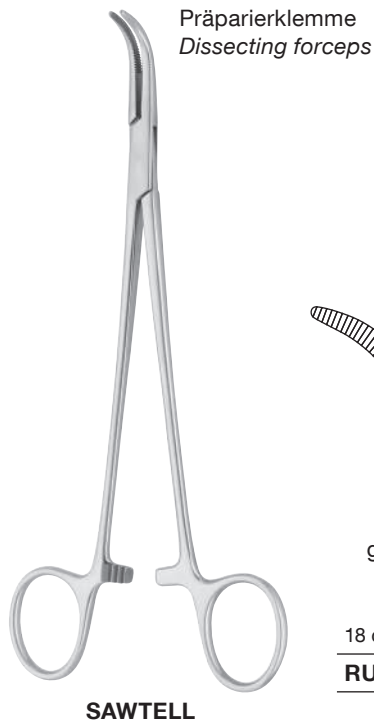



MIXTER-SLIM

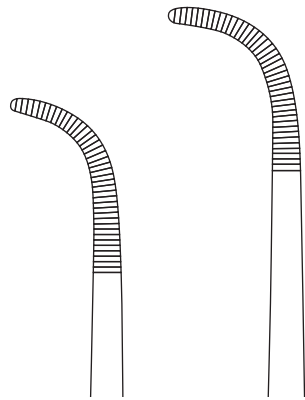

gebogen
curved

18 cm – 7"	23 cm – 9"
RU 3336-18	RU 3336-23



MIXTER

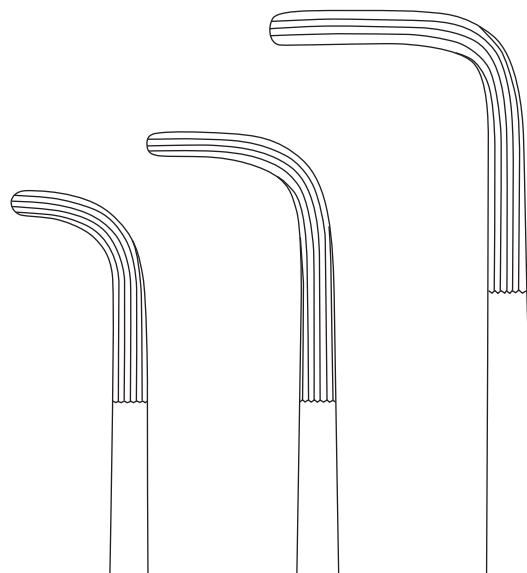

gebogen
curved

gebogen
curved

gebogen
curved

22 cm – 8¾"	25 cm – 10"	28 cm – 11"
RU 3341-22	RU 3342-25	RU 3343-28



MIXTER

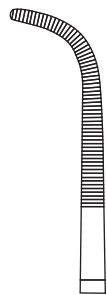

gebogen
curved

22 cm – 8¾"

RU 3350-22



WICKSTROEM

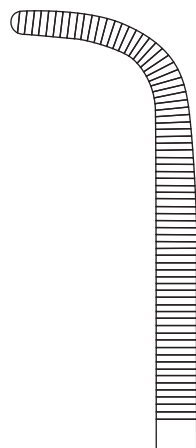

gebogen
curved

20 cm – 8"

RU 3351-20



FINOCCHIETTO

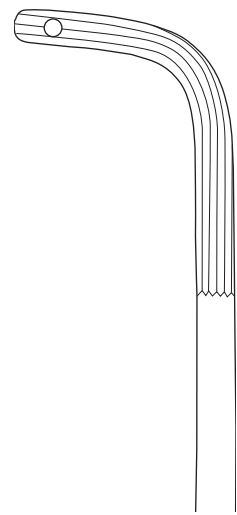

gebogen
curved

24 cm – 9½"

RU 3352-24



LAWRENCE

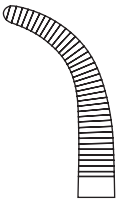

gebogen
curved

27,5 cm – 10¾"

RU 3355-27



LAHEY

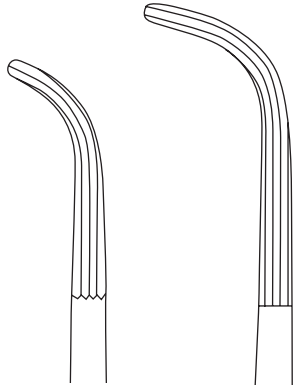

gebogen
curved

19 cm – 7½"

RU 3361-19

23 cm – 9"

RU 3361-23



SPENCER-WELLS

gerade straight	gerade straight	gerade straight	gerade straight	gerade straight
13 cm – 5"	14 cm – 5½"	15 cm – 6"	18 cm – 7"	20 cm – 8"
RU 3380-13	RU 3380-14	RU 3380-15	RU 3380-18	RU 3380-20

gebogen curved	gebogen curved	gebogen curved	gebogen curved	gebogen curved
13 cm – 5"	14 cm – 5½"	15 cm – 6"	18 cm – 7"	20 cm – 8"
RU 3381-13	RU 3381-14	RU 3381-15	RU 3381-18	RU 3381-20

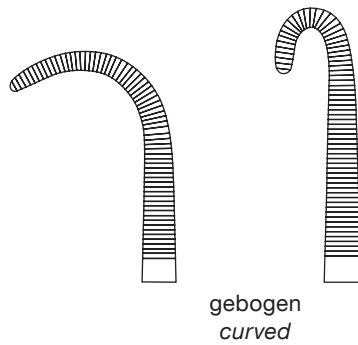

19 cm – 7½"

RU 3387-01	RU 3387-02
-------------------	-------------------

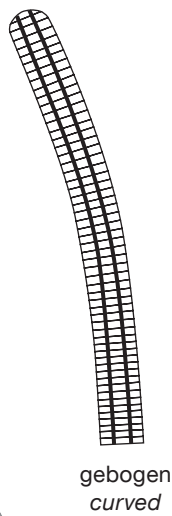

21 cm – 8¼"

RU 3392-21

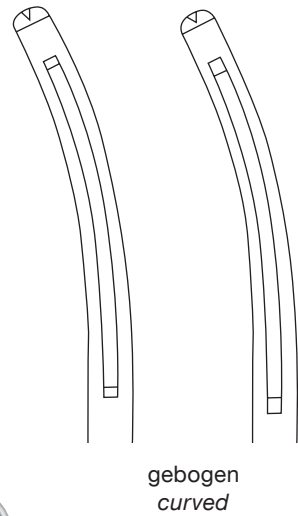

20,5 cm – 8"

25 cm – 10"

RU 3394-20	RU 3394-25
-------------------	-------------------



FAURE

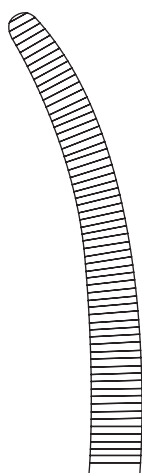

gebogen
curved

25 cm – 10"

RU 3433-45



WERTHEIM

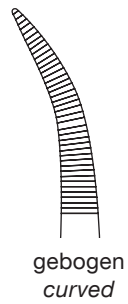

gebogen
curved

18 cm – 7"

RU 3438-18



BABY-MIKULICZ

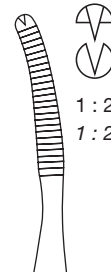

1 : 2 Zähne
1 : 2 teeth

gebogen
curved

14 cm – 5½"

RU 3492-14



MIKULICZ

1 : 2 Zähne
1 : 2 teeth

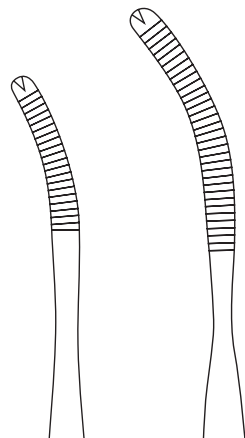

gebogen
curved

18 cm – 7"

20 cm – 8"

RU 3500-18 | **RU 3500-20**



MIKULICZ

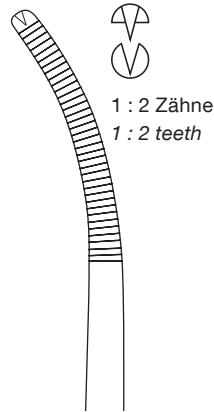

1 : 2 Zähne
1 : 2 teeth

gebogen
curved

20 cm – 8"

RU 3501-20



MIKULICZ

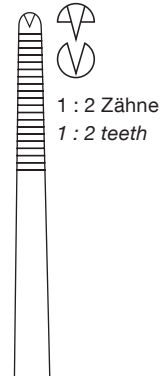

1 : 2 Zähne
1 : 2 teeth

seitlich gebogen
curved sideways

18,5 cm – 7¼"

RU 3502-18



MIKULICZ

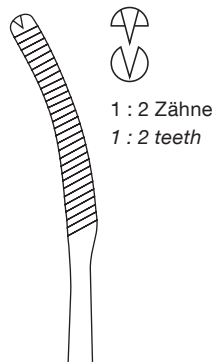

1 : 2 Zähne
1 : 2 teeth

gebogen
curved

18 cm – 7"

RU 3504-18



MIKULICZ

1 : 2 Zähne
1 : 2 teeth

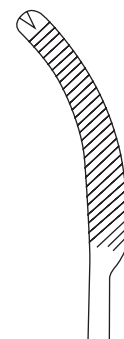

gebogen
curved

20 cm – 8"

RU 3505-20 | **RU 3506-20**

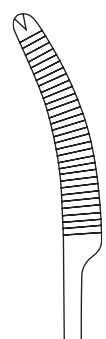

Peritoneumklemmen Peritoneal Forceps



1 : 2 Zähne
1 : 2 teeth

FAURE



leicht gebogen
slightly curved



gebogen
curved

20 cm – 8"

RU 3511-20

RU 3512-20

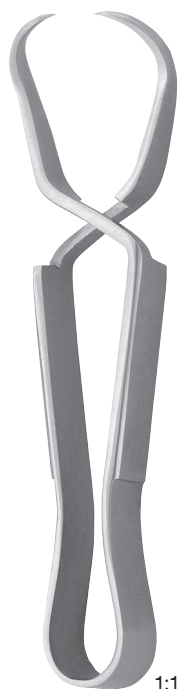

1:1
SCHÄDEL

gebogen
curved

9 cm – 3½"

RU 3550-09



1:1
JONES

gebogen
curved

6 cm – 2½"

RU 3552-05



1:1
JONES

gebogen
curved

9 cm – 3½"

RU 3552-09



1:1
**ENGLISHES MODELL
ENGLISH PATTERN**

gebogen
curved

9 cm – 3½"

RU 3553-09



BACKHAUS

9 cm – 3½"	RU 3600-09
11 cm – 4¼"	RU 3600-11
13 cm – 5"	RU 3600-13
15 cm – 6"	RU 3600-15



Tuchklemme
mit Schlauch-
oder Kabelhalter
*Towel forceps
with clip for tubing
or cable*

11 cm – 4¼"	RU 3602-11
13 cm – 5"	RU 3602-13



PEERS-BERTRAM



14,5 cm – 5¾"	RU 3604-14
---------------	-------------------



TOHOKU



10 cm – 4"	RU 3605-10
13 cm – 5"	RU 3605-13



Tuchklemme
für Papiertücher
*Towel forceps
for paper tissues*



11 cm – 4¼"	RU 3617-11
14 cm – 5½"	RU 3617-13



LORNA



10 cm – 4"	RU 3618-10
13 cm – 5"	RU 3618-13



BERNHARD

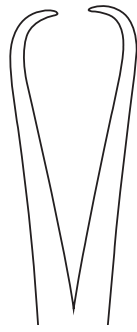

16,5 cm – 6½"

RU 3620-16



LANE



13 cm – 5"

RU 3622-13



15,5 cm – 6"

RU 3622-15



20 cm – 8"

RU 3622-20

Schlauchklemmen Tubing Forceps

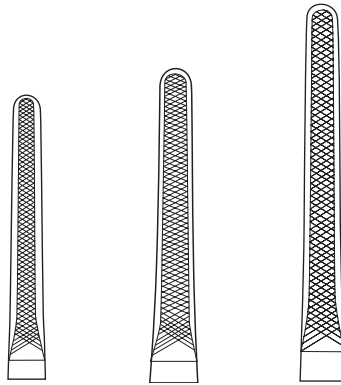

15 cm - 6"	18 cm - 7"	20 cm - 8"
RU 3680-15	RU 3680-18	RU 3680-20



14,5 cm - 5¾"
RU 3682-14

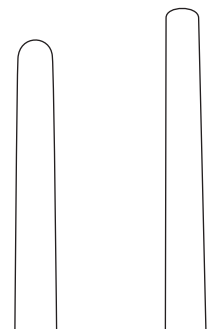

glatt
smooth

16,5 cm - 6½"	18 cm - 7"
RU 3684-16	RU 3684-18

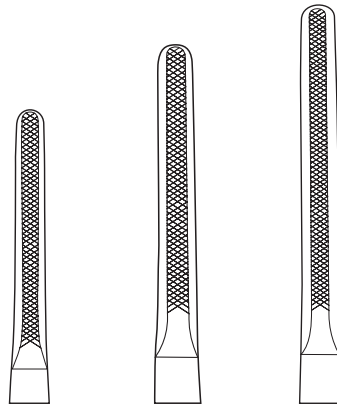

15 cm – 6"	18 cm – 7"	20 cm – 8"
RU 3686-15	RU 3686-18	RU 3686-20



max. Schlauch-Durchmesser <i>max. tubing diameter</i>	
8 mm	RU 3692-13
10 mm	RU 3692-17
12 mm	RU 3692-20
15 mm	RU 3692-25
18 mm	RU 3692-30
25 mm	RU 3692-40



ULRICH

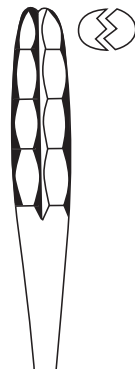

gerade
straight

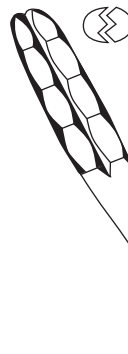

gebogen
curved

22 cm – 8¾"	RU 3800-22
25 cm – 10"	RU 3800-25
27 cm – 10½"	RU 3800-27

22 cm – 8¾"	RU 3801-22
25 cm – 10"	RU 3801-25
27 cm – 10½"	RU 3801-27



LISTER

Sinusklemmen
Sinus forceps



gerade
straight



gerade
straight

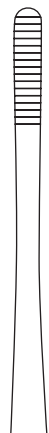

gerade
straight

12,5 cm – 5"	16 cm – 6¼"	18 cm – 7"
RU 3810-12	RU 3810-16	RU 3810-18

Korn-(Polypen) Zange
Dressing and polypus forceps



BRYANT

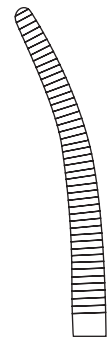

gebogen
curved

13 cm – 5"
RU 3812-13



GROSS-MAIER

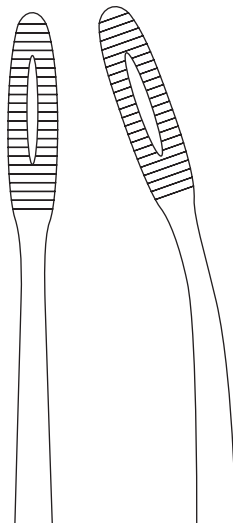

mit Sperre
with ratchet

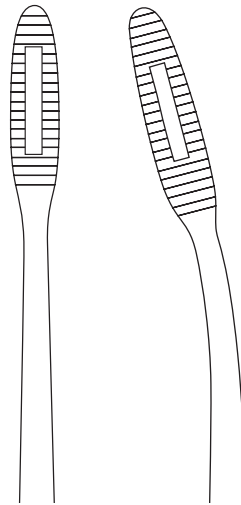

ohne Sperre
without ratchet

gerade <i>straight</i>	gebogen <i>curved</i>	gerade <i>straight</i>	gebogen <i>curved</i>
20 cm – 8"		20 cm – 8"	
RU 3860-20	RU 3861-20	RU 3862-20	RU 3863-20



GROSS-MAIER

1:3

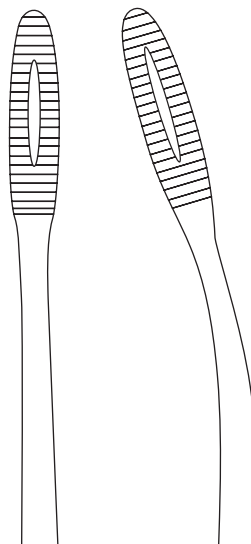

mit Sperre
with ratchet

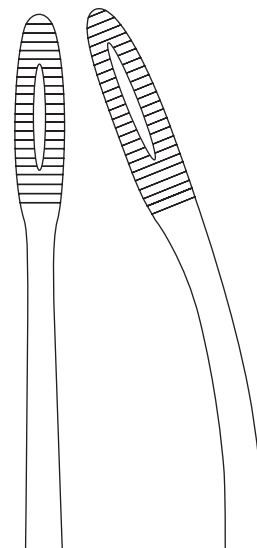

ohne Sperre
without ratchet

gerade <i>straight</i>	gebogen <i>curved</i>	gerade <i>straight</i>	gebogen <i>curved</i>
25 cm – 10"		25 cm – 10"	
RU 3860-25	RU 3861-25	RU 3862-25	RU 3863-25

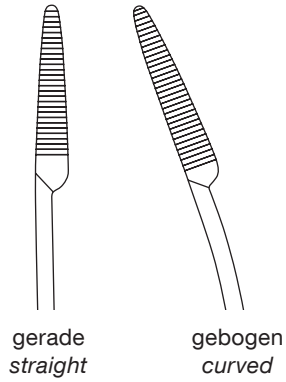

25 cm – 10"

RU 3872-25

RU 3873-25

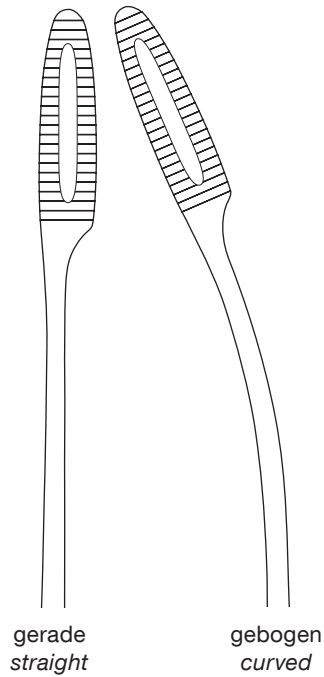

28 cm – 11"

RU 3874-28

RU 3875-28

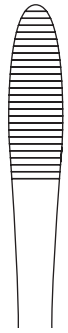

gerade
straight

25 cm – 10"

RU 3887-25

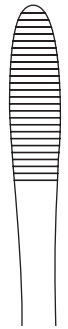

gebogen
curved

25 cm – 10"

RU 3888-25



gerade
straight

21 cm – 8¼"

RU 3889-21



gerade
straight

26 cm – 10¼"

RU 3890-26

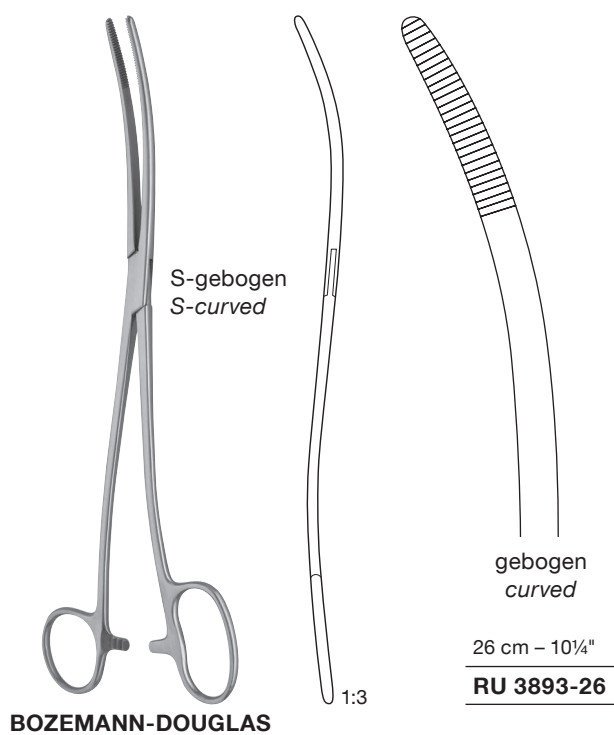
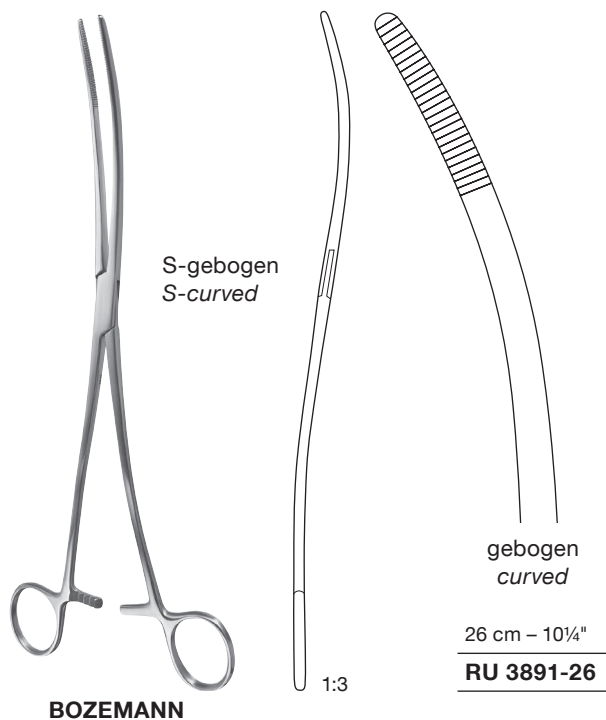

Schwammzangen Sponge Holding Forceps



FÖRSTER-BALLENGER

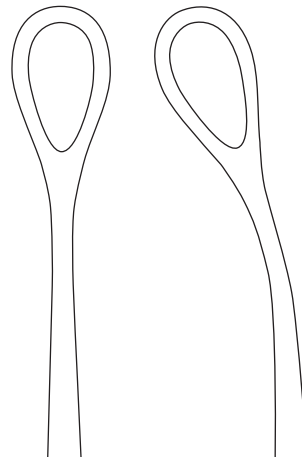

gerade, glatt
straight, smooth

gebogen, glatt
curved, smooth

18 cm – 7"	RU 3900-18	RU 3901-18
25 cm – 10"	RU 3900-25	RU 3901-25



FÖRSTER-BALLENGER

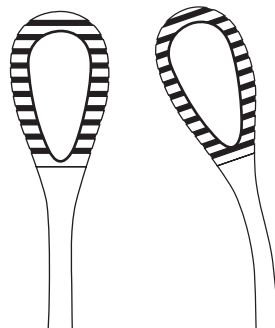

gerade, gerieft
straight, serrated

gebogen, gerieft
curved, serrated

18 cm – 7"	RU 3910-18	RU 3911-18
25 cm – 10"	RU 3910-25	RU 3911-25

Schwammzangen
Sponge Holding Forceps



RAMPLAY

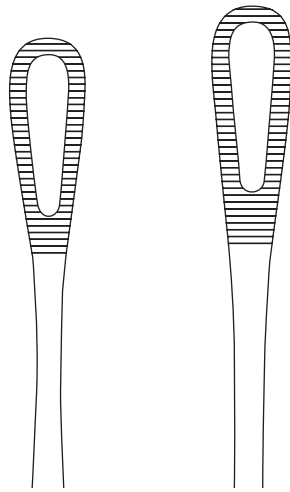

gerade
straight

18 cm – 7"	25 cm – 10"
RU 3896-18	RU 3896-25



COLLIN

Zungenzange
Tongue holding forceps

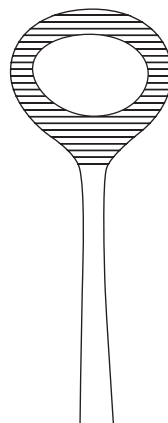

16 cm – 6¼"
RU 8450-16

Bulldogklemmen

Bulldog Clamps

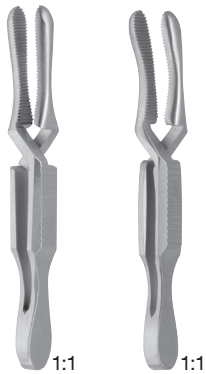

DIEFFENBACH

	gerade <i>straight</i>	gebogen <i>curved</i>
3,5 cm – 1½"	RU 3144-03	RU 3145-03
5 cm – 2"	RU 3144-05	RU 3145-05



DIEFFENBACH

	gerade <i>straight</i>	gebogen <i>curved</i>
6 cm – 2½"	RU 3144-06	RU 3145-06



JOHNS-HOPKINS

	gerade <i>straight</i>	gebogen <i>curved</i>
3,8 cm – 1½"	RU 3146-11	RU 3146-01
4,8 cm – 2"	RU 3146-12	RU 3146-02
5,7 cm – 2¼"	RU 3146-13	RU 3146-03
6,3 cm – 2½"	RU 3146-14	RU 3146-04
7 cm – 2¾"	RU 3146-15	RU 3146-05
7,5 cm – 3"	RU 3146-16	RU 3146-06
9 cm – 3½"	RU 3146-17	RU 3146-07

Bulldogklemmen

Bulldog Clamps



Mikro-Clips
Micro clips



gerade
straight

2,7 cm – 1¼"

RU 3930-01



SCHWARTZ

leicht gebogen
slightly curved

2,7 cm – 1¼"

RU 3930-02



stark gebogen
strongly curved

2,5 cm – 1"

RU 3930-03



Anlegezange
für SCHWARTZ Mikro-Clips
Applying forceps
for SCHWARTZ micro clips

gebogen
curved

19 cm – 7½"

RU 3930-80

SCHWARTZ



1:1
DE BAKEY-HESS

gewinkelt
angled

4,5 cm – 1¾"

RU 3936-20



1:1
DE BAKEY-HESS

gewinkelt
angled

5,5 cm – 2¼"



RU 3936-30

Bulldogklemmen

Bulldog Clamps

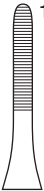

1:1

		
10 mm	14 mm	18 mm
3 cm – 1¼"	3,5 cm – 1½"	4 cm – 1½"
RU 3932-00	RU 3932-04	RU 3932-08



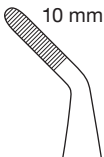
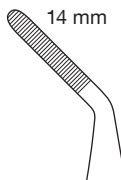
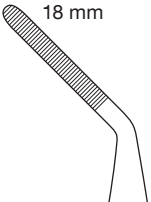

1:1

		
10 mm	14 mm	18 mm
3 cm – 1¼"	3,5 cm – 1½"	4 cm – 1½"
RU 3932-10	RU 3932-14	RU 3932-18

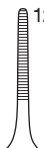
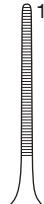

1:1

		
8 mm	12 mm	16 mm
4,9 cm – 2"	5,3 cm – 2"	5,6 cm – 2¼"
RU 3934-08	RU 3934-12	RU 3934-16

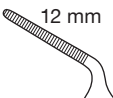
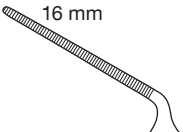
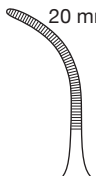
			
8 mm	12 mm	16 mm	20 mm
4,3 cm – 1½"	4,5 cm – 1½"	5,6 cm – 2¼"	5,4 cm – 2"
RU 3935-08	RU 3935-12	RU 3935-16	RU 3935-21

DIETRICH





1:1

DIETRICH

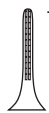
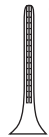
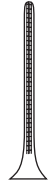

DE BAKEY Zahnung
DE BAKEY Serration

 10 mm	 14 mm	 20 mm	 20 mm
4,7 cm – 2"	5,1 cm – 2"	5,7 cm – 2¼"	5,4 cm – 2"
RU 3934-60	RU 3934-64	RU 3934-70	RU 3934-71

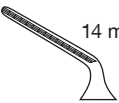
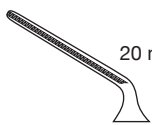
 10 mm	 14 mm	 20 mm
4,4 cm – 1½"	4,6 cm – 1½"	4,9 cm – 2"
RU 3935-60	RU 3935-64	RU 3935-70





Feine Wundhäkchen	<i>Fine Wound Retractors</i>	RE 1 - 2
Wund- und Trachealhäkchen	<i>Wound and Trachea Retractors</i>	RE 3 - 6
Wundhaken	<i>Retractors</i>	RE 7 - 29
Spatel	<i>Spatulas</i>	RE 30
Wundspreizer	<i>Self-retaining Retractors</i>	RE 31 - 47, RE 49
Spezialwundspreizer	<i>Special Retractors</i>	RE 48
Bauchdeckenhalter	<i>Abdominal Retractors</i>	RE 50 - 64

Feine Wundhäkchen
Fine Wound Retractors

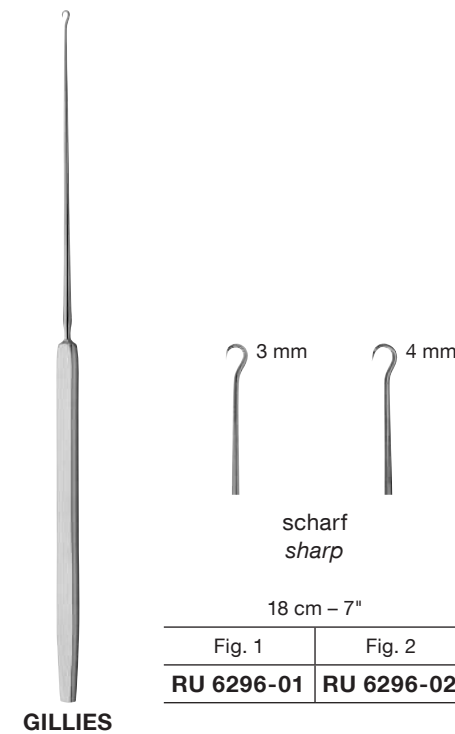
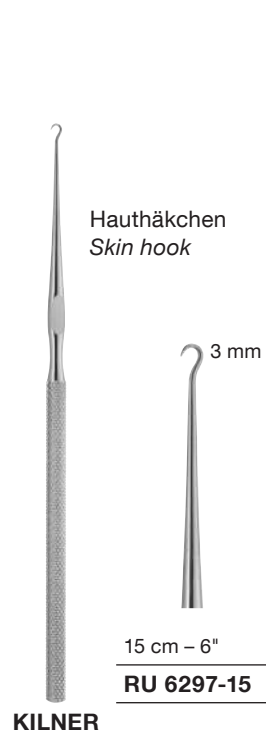
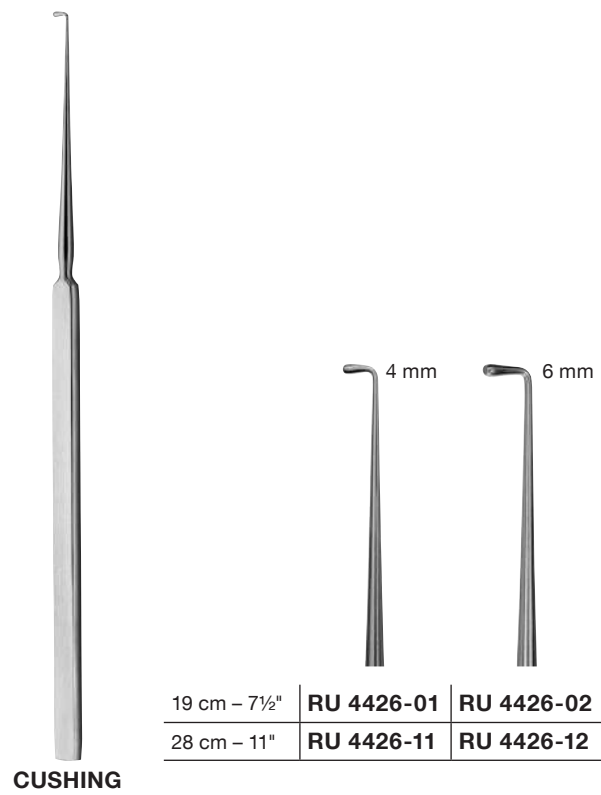

Feine Wundhäkchen Fine Wound Retractors

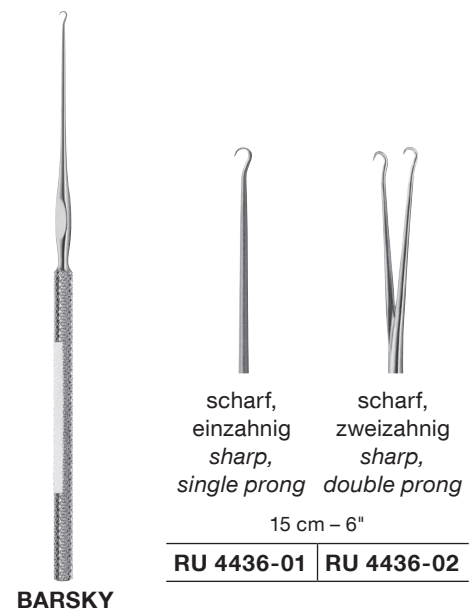
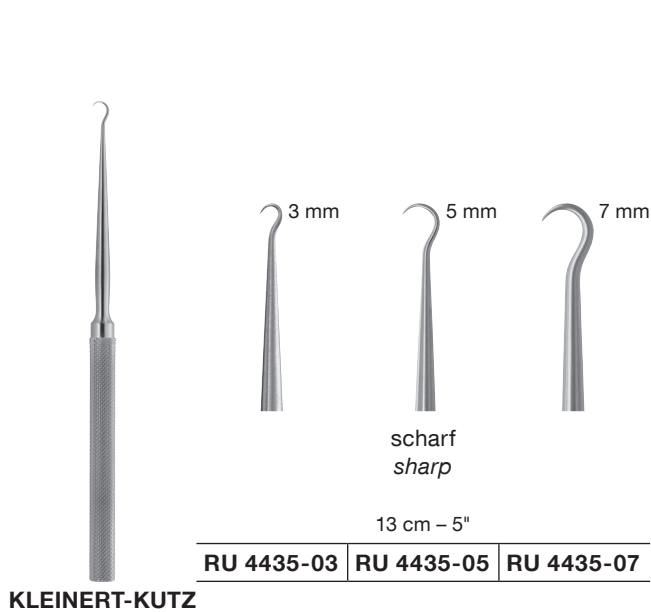
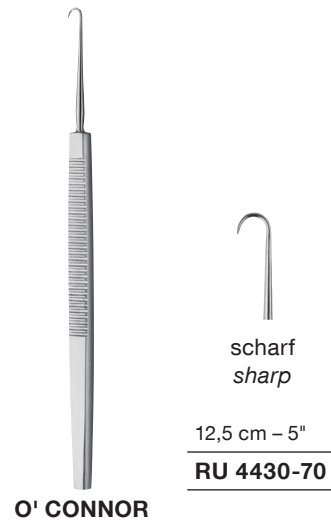
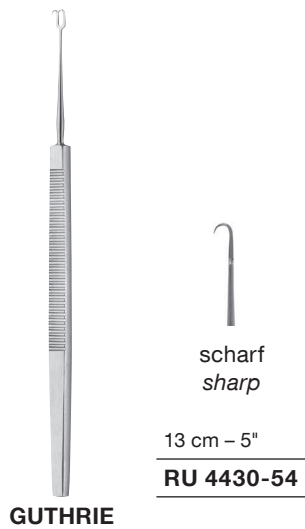
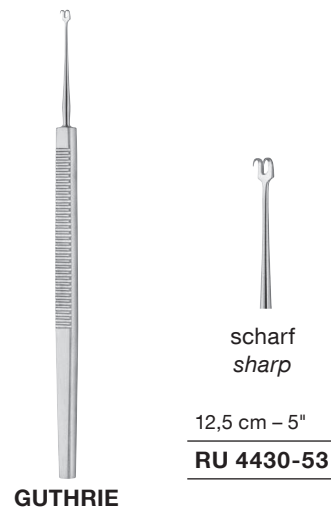
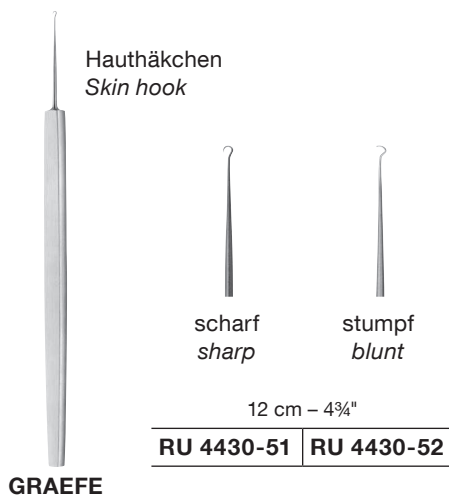

Wund- und Trachealhäkchen Wound and Trachea Retractors

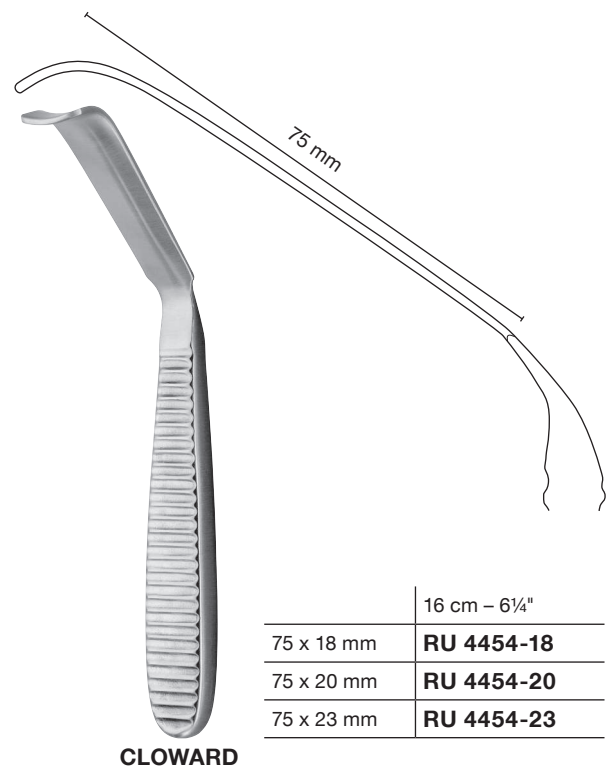
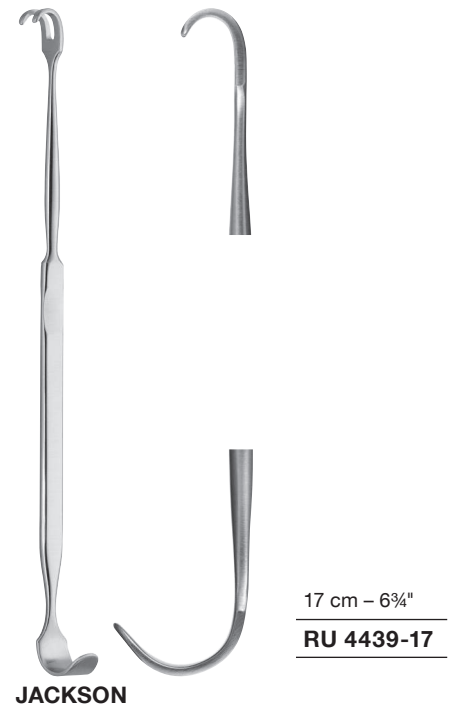
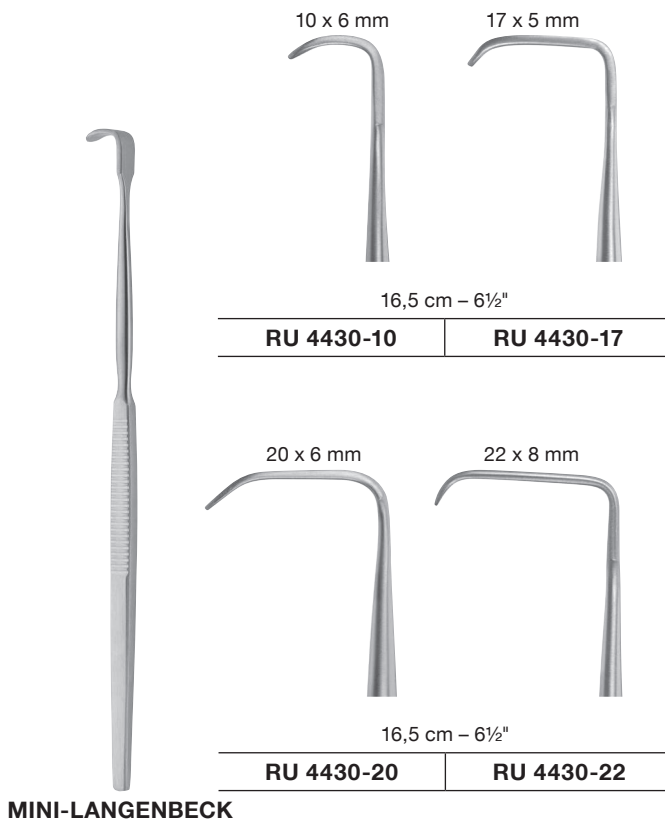

Wund- und Trachealhäkchen Wound and Trachea Retractors



scharf
sharp

16,5 cm – 6½"

RU 4460-01	RU 4460-02	RU 4460-03	RU 4460-04
------------	------------	------------	------------



stumpf
blunt

16,5 cm – 6½"

RU 4461-01	RU 4461-02	RU 4461-03	RU 4461-04
------------	------------	------------	------------



scharf
sharp

16 cm – 6¼"

RU 4462-01	RU 4462-02	RU 4462-03	RU 4462-04
------------	------------	------------	------------



stumpf
blunt

16 cm – 6¼"

RU 4463-01	RU 4463-02	RU 4463-03	RU 4463-04
------------	------------	------------	------------

Wund- und Trachealhäkchen Wound and Trachea Retractors



scharf
sharp

15,5 cm – 6"

RU 4464-01	RU 4464-02	RU 4464-03	RU 4464-04
-------------------	-------------------	-------------------	-------------------



flexibel
flexible



stumpf
blunt

15,5 cm – 6"

RU 4465-01	RU 4465-02	RU 4465-03	RU 4465-04
-------------------	-------------------	-------------------	-------------------



scharf
sharp



stumpf
blunt

16 cm – 6¼"

RU 4466-01	RU 4466-02
-------------------	-------------------



13 cm – 5"

RU 4468-13

JACKSON



14 cm – 5½"

RU 4469-14

BERGMANN

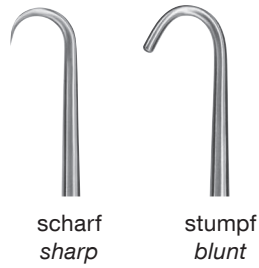
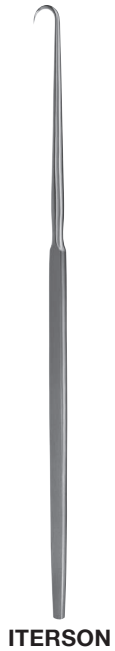

16 cm – 6¼"

Fig. 1	Fig. 2
RU 4471-01	RU 4471-02



scharf
sharp

11,5 cm – 4½"

RU 4472-02	RU 4472-03	RU 4472-04	RU 4472-06
-------------------	-------------------	-------------------	-------------------



stumpf
blunt

11,5 cm – 4½"

RU 4473-02	RU 4473-03	RU 4473-04	RU 4473-06
-------------------	-------------------	-------------------	-------------------

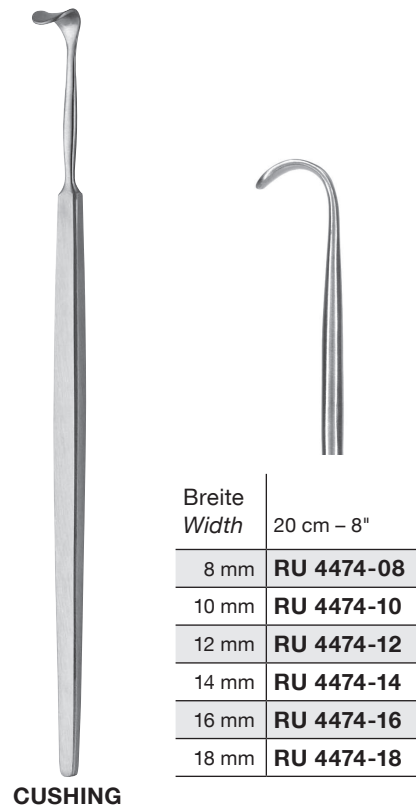
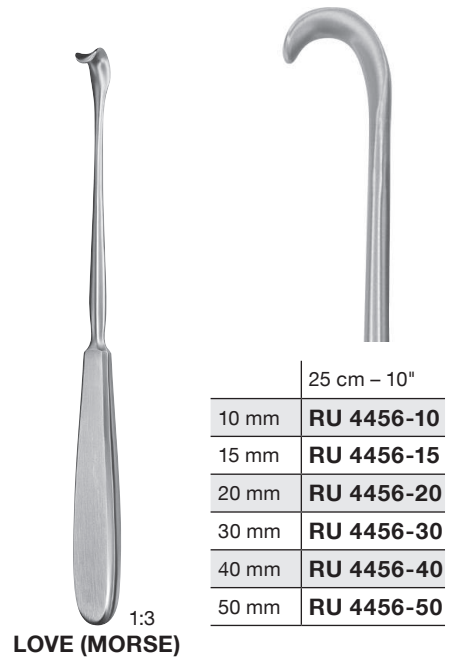



1:3

CUSHING

Breite Width	
	24 cm – 9½"
8 mm	RU 4474-58
10 mm	RU 4474-60
12 mm	RU 4474-62
14 mm	RU 4474-64
16 mm	RU 4474-66
18 mm	RU 4474-68

DESMARRES

Breite Width	
	14 cm – 5½"
8 mm	RU 4475-08
10 mm	RU 4475-10
11 mm	RU 4475-11
12 mm	RU 4475-12
13 mm	RU 4475-13
14 mm	RU 4475-14
15 mm	RU 4475-15
16 mm	RU 4475-16
18 mm	RU 4475-18

12 x 4 mm

20 x 6 mm

CRILE

	11 cm – 4¼"
	RU 4478-11

LUER

	11 cm – 4¼"
	RU 4479-11



	17 cm – 6¾"
6 x 25 mm	RU 4481-01
8 x 25 mm	RU 4481-02

LANGENBECK-GREEN



Dekompressionshaken
Decompression hook

CUSHING

20 cm – 8"
RU 4485-20

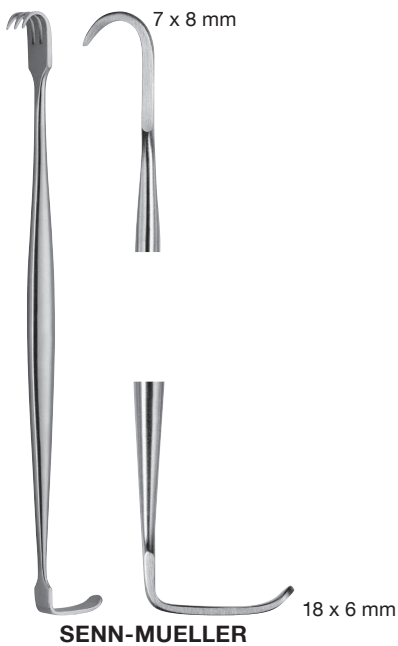

7 x 8 mm

18 x 6 mm

SENN-MUELLER

scharf <i>sharp</i>	stumpf <i>blunt</i>
16 cm – 6¼"	
RU 4486-01	RU 4486-02



7 x 8 mm

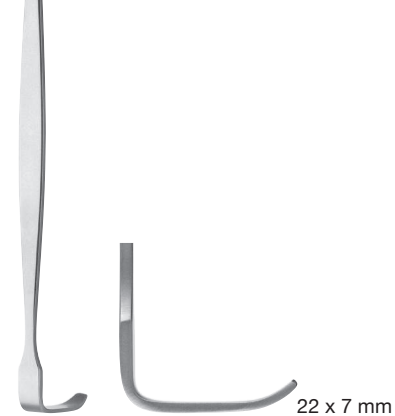

22 x 7 mm

BABY-SENN-MUELLER

scharf <i>sharp</i>	stumpf <i>blunt</i>
15,5 cm – 6"	
RU 4487-01	RU 4487-02



7 x 3,5 mm

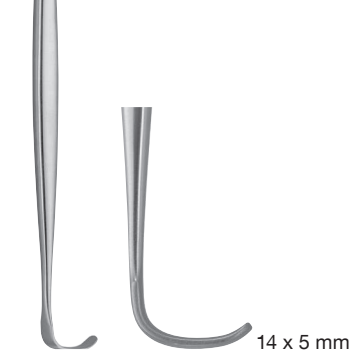

14 x 5 mm

RAGNELL-DAVIS

15 cm – 6"
RU 4488-14



10 x 6 mm



20 x 6 mm



16 cm – 6¼"

RU 4489-01	RU 4489-02
-------------------	-------------------

SENN-GREEN



LANGENBECK-GREEN



scharf
sharp

16 cm – 6¼"

RU 4490-01	RU 4490-02	RU 4490-03
-------------------	-------------------	-------------------

11 x 13 mm



16 x 6 mm



25 x 6 mm



16 cm – 6¼"

RU 4490-13	RU 4490-16	RU 4490-25
-------------------	-------------------	-------------------



ROUX

RU 4492-00

Satz bestehend aus:
RU 4492-01, RU 4492-02, RU 4492-03
Set consisting of:
RU 4492-01, RU 4492-02, RU 4492-03

14 cm – 5½"	Fig. 1	RU 4492-01
15 cm – 6"	Fig. 2	RU 4492-02
17 cm – 6¾"	Fig. 3	RU 4492-03



BABY-ROUX

17 x 16 mm

18 x 22 mm

13 cm – 5"

RU 4492-13

30 x 31 mm



GOELET

37 x 40 mm

19 cm – 7½"

RU 4493-19

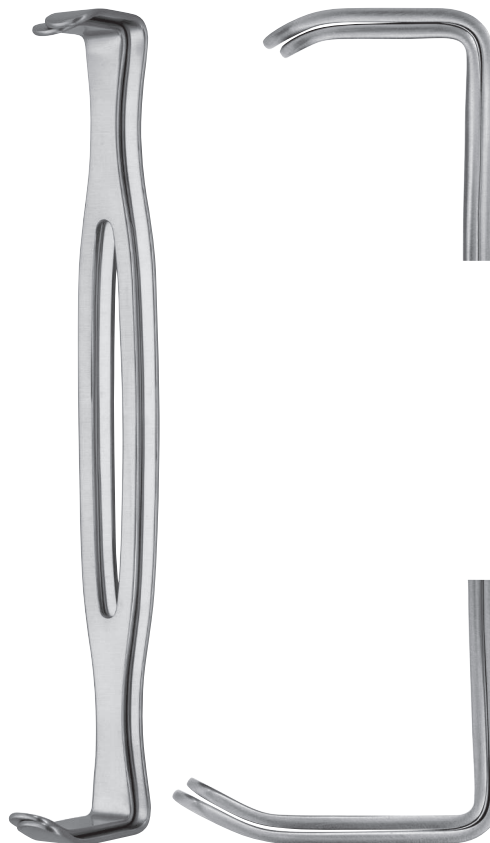

PARKER-LANGENBECK

Satz
Set

21 cm – 8¼"

RU 4494-21



Satz
Set
13,5 cm – 5¼"
RU 4495-13

PARKER



Satz
Set
18 cm – 7"
RU 4495-18

PARKER



Satz
Set
16 cm – 6¼"
RU 4496-00

PARKER-MOTT



FARABEUF

Satz
Set
12 cm – 4¾"
RU 4497-12



FARABEUF

Satz
Set
15 cm – 6"
RU 4497-15



COLLIN

Satz
Set
16,5 cm – 6½"
RU 4498-00



MATHIEU

Satz
Set
19 cm – 7½"
RU 4499-00



OLLIER



22,5 cm – 8¾"

RU 4510-03	RU 4510-04
-------------------	-------------------

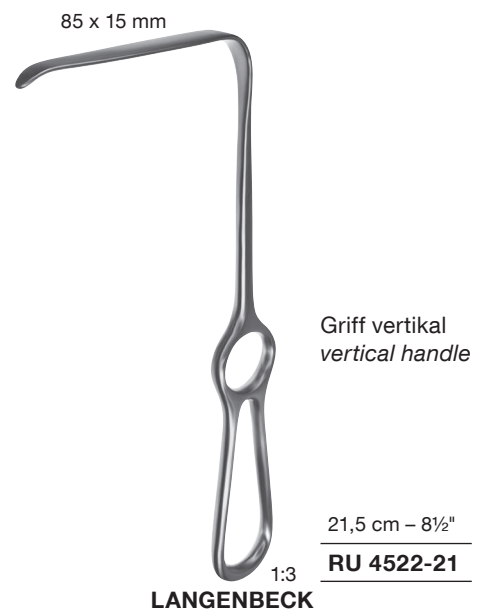
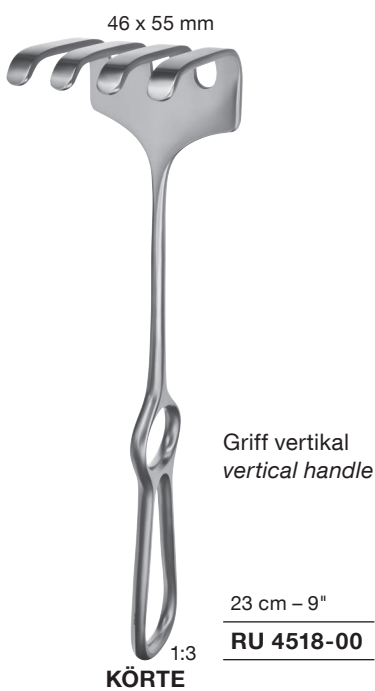
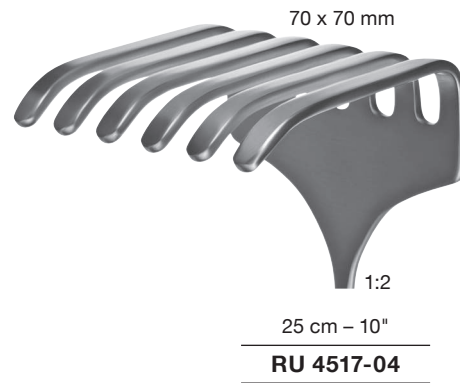
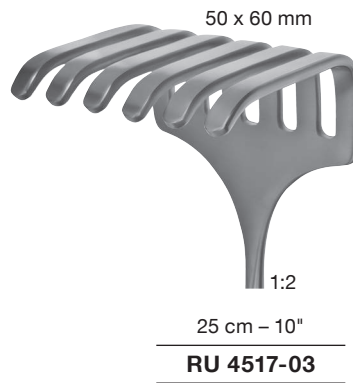
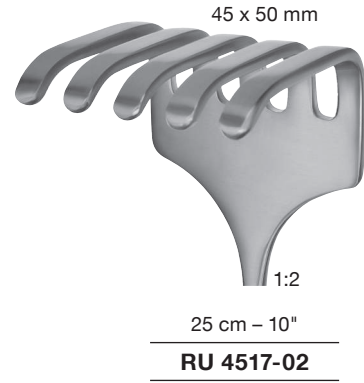
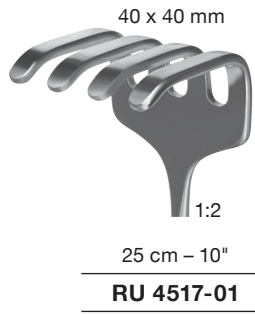
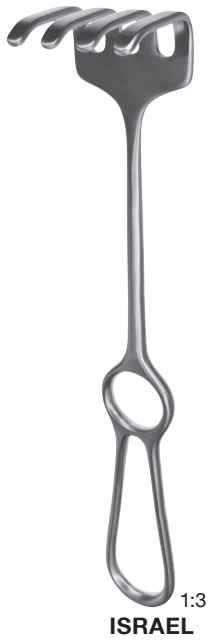



	21 cm – 8¼"
55 x 20 mm	RU 4522-01
63 x 20 mm	RU 4522-02
60 x 20 mm	RU 4522-05

LANGENBECK



	23 cm – 9"
35 x 7 mm	RU 4523-01
35 x 10 mm	RU 4523-02
35 x 15 mm	RU 4523-03
60 x 20 mm	RU 4523-04

LANGENBECK

28 x 6 mm



	19 cm – 7½"
	RU 4525-19

LAHEY



	22,5 cm – 8¾"
45 x 15 mm	RU 4526-01
55 x 23 mm	RU 4526-02
72 x 20 mm	RU 4526-03

SAUERBRUCH



	21 cm – 8¼"
30 x 11 mm	RU 4530-01
30 x 14 mm	RU 4530-02
33 x 14 mm	RU 4530-03
30 x 16 mm	RU 4530-04
40 x 11 mm	RU 4530-05
42 x 13 mm	RU 4530-06
50 x 11 mm	RU 4530-07

LANGENBECK

38 x 20 mm



KOCHER

	22 cm – 8¾"
	RU 4535-01



Hohlheftgriff
Hollow handle

	22 cm – 8¾"
30 x 11 mm	RU 4531-01
40 x 11 mm	RU 4531-05
42 x 13 mm	RU 4531-06

LANGENBECK



KOCHER



	19 cm – 7½"
19 x 12 mm	RU 4536-01
21 x 12 mm	RU 4536-02



KOCHER-LANGENBECK

	21,5 cm – 8½"
25 x 6 mm	RU 4538-11
25 x 8 mm	RU 4538-12
35 x 8 mm	RU 4538-13
35 x 11 mm	RU 4538-14
35 x 15 mm	RU 4538-15
40 x 11 mm	RU 4538-16
55 x 11 mm	RU 4538-17
70 x 14 mm	RU 4538-18
80 x 12 mm	RU 4538-19
80 x 16 mm	RU 4538-20



CASPAR

	21,5 cm – 8½"
	RU 4537-21



KOCHER

	23 cm – 9"
40 x 18 mm	RU 4539-11
60 x 20 mm	RU 4539-12
60 x 25 mm	RU 4539-13
75 x 30 mm	RU 4539-14
75 x 40 mm	RU 4539-15



KOCHER-WAGNER

	28 cm – 11"
22 x 15 mm	RU 4540-01
38 x 20 mm	RU 4540-02
67 x 25 mm	RU 4540-03
100 x 35 mm	RU 4540-04

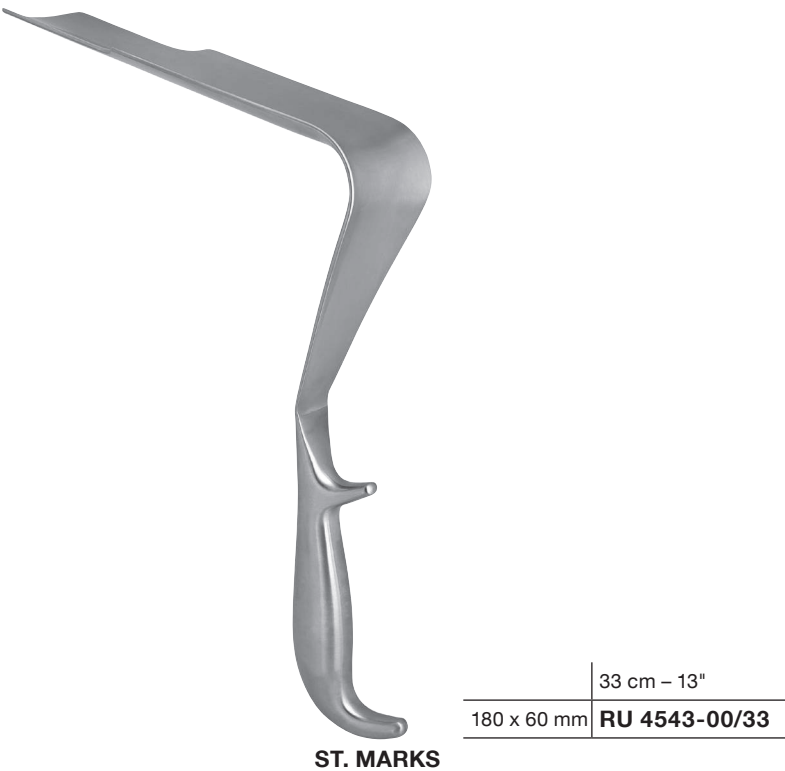
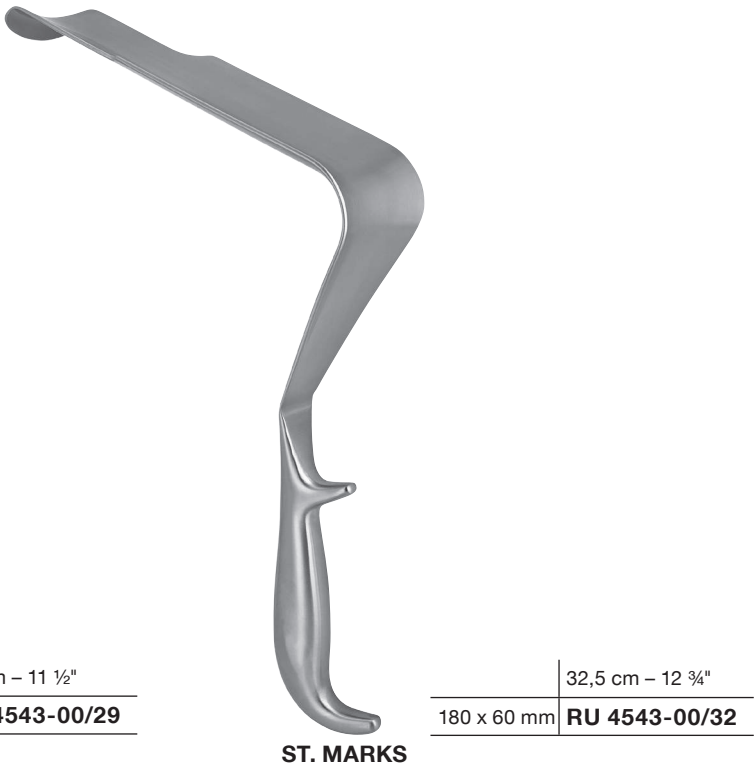
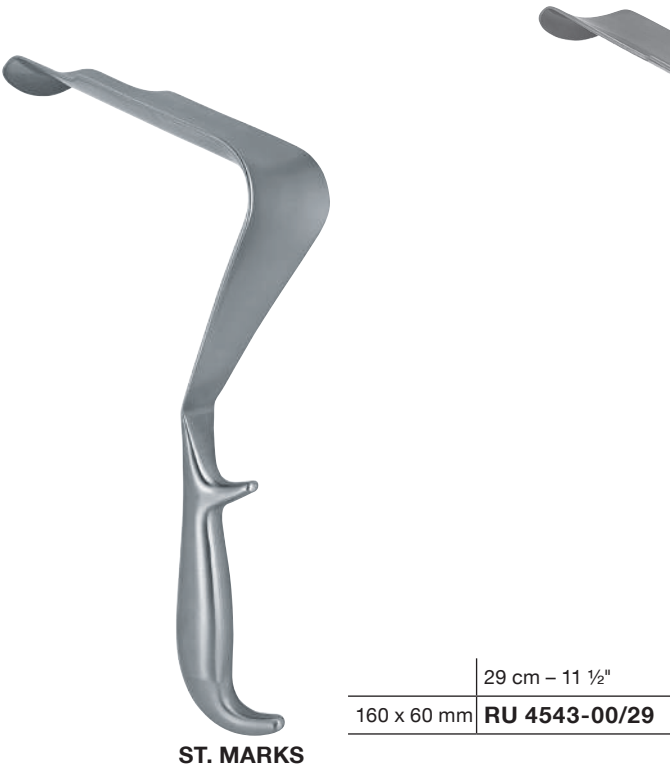



HÖSEL

	25 cm – 10"
60 x 20 mm	RU 4542-01
80 x 30 mm	RU 4542-02
100 x 30 mm	RU 4542-03
120 x 30 mm	RU 4542-04
140 x 30 mm	RU 4542-05
140 x 40 mm	RU 4542-06

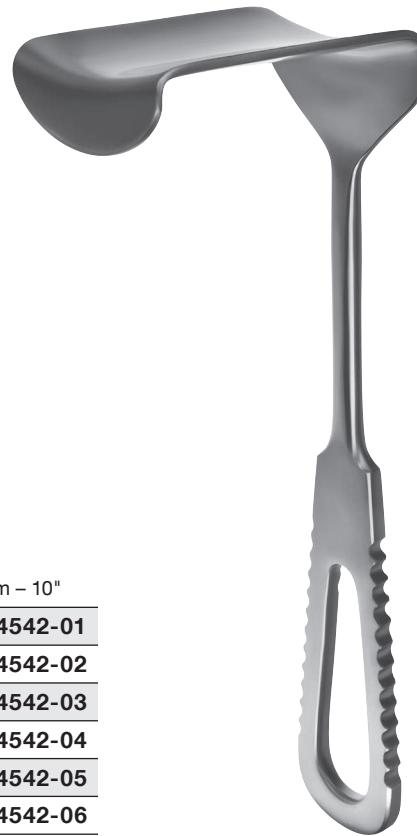

MORRIS

	21 cm – 8¼"
70 x 40 mm	RU 4544-40
70 x 50 mm	RU 4544-50
70 x 65 mm	RU 4544-65



CANNY-RYALL

19 cm – 7½"	16 mm	RU 4544-47
19 cm – 7½"	20 mm	RU 4544-48
20 cm – 8"	25 mm	RU 4544-49



MORRIS

	24 cm – 9½"
32 x 50 mm / 38 x 50 mm	RU 4544-01
45 x 50 mm / 50 x 50 mm	RU 4544-02
65 x 50 mm / 38 x 50 mm	RU 4544-03

Wundhaken
Retractors



1:3
WYLIE

30,5 cm – 12"	75 x 23 mm	RU 4548-30
33 cm – 13"	175 x 23 mm	RU 4548-33



GREEN

22 cm – 8¾"	RU 4549-22
-------------	-------------------



MIDDELDORPF

21,5 cm – 8½"	14 x 17 mm	RU 4551-01
22 cm – 8¾"	20 x 22 mm	RU 4551-02
23,5 cm – 9¼"	26 x 30 mm	RU 4551-03

1:3

MIDDELDORPF

	25,5 cm – 10"
45 x 45 mm	RU 4551-51
45 x 50 mm	RU 4551-52
55 x 70 mm	RU 4551-53



1:3
RICHARDSON

	24 cm – 9½"
28 x 20 mm	RU 4552-11
30 x 28 mm	RU 4552-12
38 x 37 mm	RU 4552-13
52 x 22 mm	RU 4552-14



1:3
RICHARDSON-EASTMAN

RU 4553-00

Satz bestehend aus:
RU 4553-01, RU 4553-02

Set consisting of:
RU 4553-01, RU 4553-02

25 cm – 10"	24 x 22 mm / 30 x 30 mm	Fig. 1	RU 4553-01
27 cm – 10½"	40 x 37 mm / 65 x 43 mm	Fig. 2	RU 4553-02



1:3
RICHARDSON

	23,5 cm – 9¼"
	RU 4552-55



1:3
RICHARDSON

	24 cm – 9½"
64 x 41 mm	RU 4552-51
25 x 19 mm	RU 4552-52
32 x 25 mm	RU 4552-53
38 x 38 mm	RU 4552-54



KELLY

1:3

	26 cm – 10¼"
40 x 50 mm	RU 4554-00
50 x 65 mm	RU 4554-01
65 x 75 mm	RU 4554-02
75 x 90 mm	RU 4554-03



KELLY

1:3

	25 cm – 10"
51 x 38 mm	RU 4554-50
64 x 51 mm	RU 4554-51
76 x 64 mm	RU 4554-52
89 x 76 mm	RU 4554-53



FRITSCH

1:3

	24 cm – 9½"
45 x 40 mm	RU 4555-01
45 x 50 mm	RU 4555-02
45 x 60 mm	RU 4555-03
45 x 75 mm	RU 4555-04
65 x 85 mm	RU 4555-05



DOYEN

1:3

50 x 85 mm	
	25 cm – 10"
	RU 4556-25



1:3
DOYEN-STILLE

	24 cm – 9½"
15 x 90 mm	RU 4557-01
20 x 90 mm	RU 4557-02
30 x 90 mm	RU 4557-03
35 x 110 mm	RU 4557-04
40 x 110 mm	RU 4557-05
55 x 120 mm	RU 4557-06



1:3
KOCHER

	22,5 cm – 8¾"
	RU 4557-22



1:3
KOCHER

	25 cm – 10"
80 x 42 mm	RU 4558-01
80 x 50 mm	RU 4558-02
80 x 60 mm	RU 4558-03



1:3
SIMON

	28 cm – 11"
115 x 22 mm	RU 4560-01
115 x 27 mm	RU 4560-02

Wundhaken Retractors



105 x 27 mm



1:3
MARTIN

26 cm – 10¼"
RU 4562-26



1:3
BRUNNER

	25 cm – 10"
80 x 20 mm	RU 4563-08
100 x 25 mm	RU 4563-10
120 x 25 mm	RU 4563-12
130 x 30 mm	RU 4563-13
140 x 30 mm	RU 4563-14
160 x 30 mm	RU 4563-16
180 x 30 mm	RU 4563-18

19 mm



DEAVER

18 cm – 7"
RU 4570-01

22 mm



DEAVER

21,5 cm – 8½"
RU 4570-02



25 mm

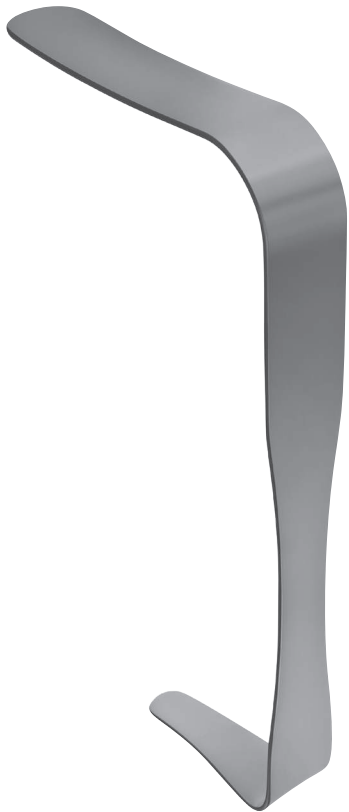

DEAVER

23 cm – 9"

RU 4570-03

25 mm



DEAVER

30 cm – 11¾"	RU 4570-04
33 cm – 13"	RU 4570-05
36 cm – 14¼"	RU 4570-06



DEAVER

	30 cm – 11¾"
38 mm	RU 4570-07
50 mm	RU 4570-08
75 mm	RU 4570-09



DEAVER

Hohlgriff
Hollow handle

	30 cm – 11¾"
25 mm	RU 4571-04
38 mm	RU 4571-07
50 mm	RU 4571-08
75 mm	RU 4571-09



1:3
HARRINGTON

	32 cm – 12½"
40 x 127 mm	RU 4572-01
62 x 127 mm	RU 4572-02



MEYERDING

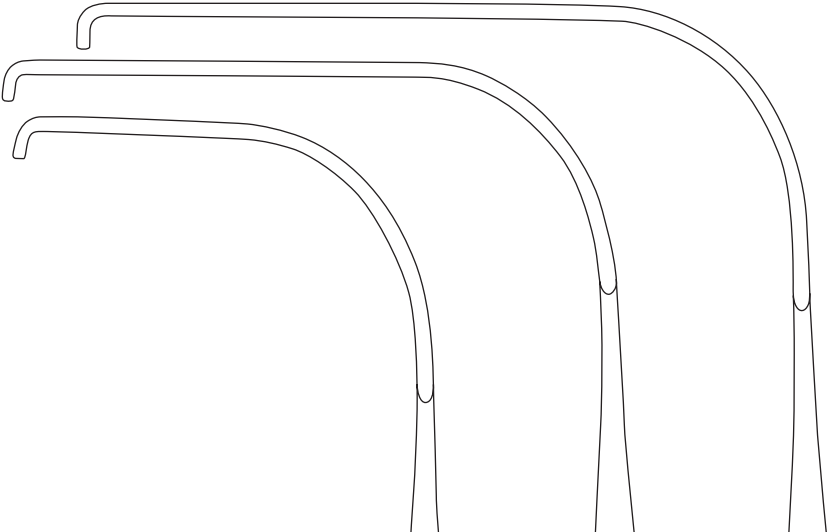

52 x 16 mm	76 x 25 mm	89 x 50 mm
23 cm – 9"	23 cm – 9"	25,5 cm – 10"
RU 4573-01	RU 4573-02	RU 4573-03



HIBBS

RU 4575-00

Satz bestehend aus:
RU 4575-01, RU 4575-02

Set consisting of:
RU 4575-01, RU 4575-02



Fig. 1

75 x 25 mm

24,5 cm – 9 $\frac{3}{4}$ "

RU 4575-01

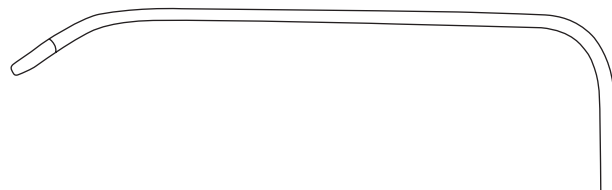
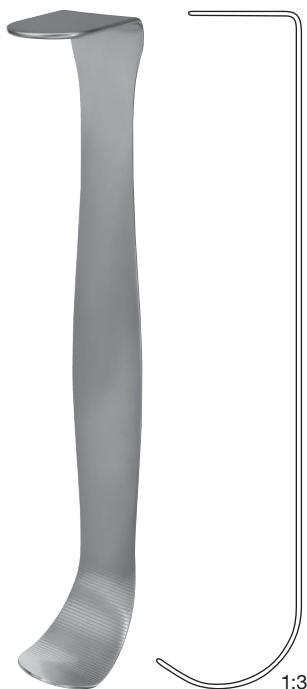

Fig. 2

80 x 25 mm

24,5 cm – 9 $\frac{3}{4}$ "

RU 4575-02



HEANEY

1:3

	27 cm – 10 $\frac{1}{2}$ "
45 x 25 mm	RU 4575-51
73 x 28 mm	RU 4575-52
82 x 28 mm	RU 4575-53



1:3

LERICHE

45 mm

25,5 cm – 10"

RU 4579-01

60 mm

27,5 cm – 10 $\frac{3}{4}$ "

RU 4579-02



1:3
BRUNNER

	25,5 cm – 10"
80 x 20 mm	RU 4564-01
100 x 20 mm	RU 4564-02
120 x 25 mm	RU 4564-03
140 x 25 mm	RU 4564-04

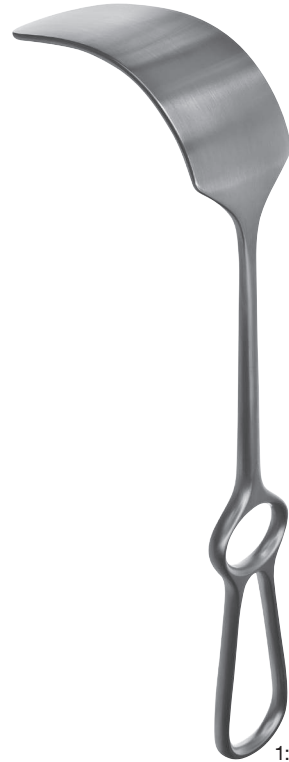

1:3
MIKULICZ

	26 cm – 10¼"
85 x 35 mm	RU 4565-01
120 x 50 mm	RU 4565-02
155 x 50 mm	RU 4565-03



1:3
MIKULICZ

	26 cm – 10¼"
	RU 4566-26



1:3
KELLY

	27 cm – 10½"
160 x 38 mm	RU 4567-01
160 x 57 mm	RU 4567-02
190 x 38 mm	RU 4567-51
190 x 57 mm	RU 4567-52



	16 cm – 6¼"
75 x 50 mm	RU 4590-01
75 x 90 mm	RU 4590-02



DAVIDSON



ROSS

		27 cm – 10½"
Fig. 1	15 x 16 mm	RU 4593-01
Fig. 2	13 x 23 mm	RU 4593-02
Fig. 3	17 x 23 mm	RU 4593-03
Fig. 4	13 x 27 mm	RU 4593-04
Fig. 5	29 x 29 mm	RU 4593-05
Fig. 6	40 x 21 mm	RU 4593-06



COOLEY



1:2

35 x 45 mm
21,5 cm – 8½"
RU 4591-01

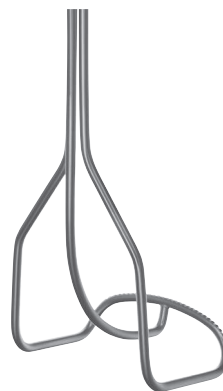

1:2

45 x 50 mm
21,5 cm – 8½"
RU 4591-02



1:2

20 x 50 mm
26 cm – 10¼"
RU 4591-03



biegsam
malleable

	33 cm – 13"
20 mm	RU 4580-20
25 mm	RU 4580-25
30 mm	RU 4580-30
35 mm	RU 4580-35
40 mm	RU 4580-40
45 mm	RU 4580-45
50 mm	RU 4580-50
64 mm	RU 4580-64
76 mm	RU 4580-76
102 mm	RU 4580-99

1:3



biegsam
malleable

17 / 25 mm
20 cm – 8"
RU 4582-20

TUFFIER



biegsam
malleable

20 cm – 8"	6 mm	RU 4584-06
	8 mm	RU 4584-08
	10 mm	RU 4584-10
	12 mm	RU 4584-12
	17 mm	RU 4584-17
25 cm – 10"	20 mm	RU 4584-20
	25 mm	RU 4584-25
25 cm – 10"	25 mm	RU 4584-29



biegsam
malleable

28 cm – 11"	25 / 30 mm	RU 4585-01
30 cm – 11¼"	37 / 45 mm	RU 4585-02
	40 / 50 mm	RU 4585-03

1:3

HABERER



28,5 cm – 11¼"
RU 4587-28

1:3

REVERDIN

Wundspreizer Self-retaining Retractors



2 : 3 Zähne
2 : 3 teeth

	scharf <i>sharp</i>	stumpf <i>blunt</i>
5 cm – 2"	RU 4640-05	RU 4641-05

FINSEN

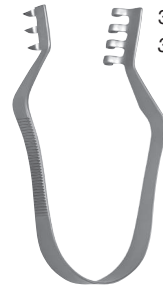

3 : 4 Zähne
3 : 4 teeth

	scharf <i>sharp</i>	stumpf <i>blunt</i>
7 cm – 2¾"	RU 4640-07	RU 4641-07

FINSEN

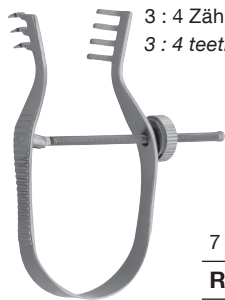

3 : 4 Zähne
3 : 4 teeth

scharf
sharp

7 cm – 2¾"
RU 4642-07

FINSEN

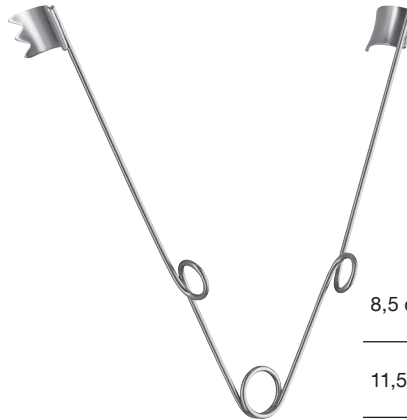

8,5 cm – 3¼"

Spreizweite: 60 mm
Spread: 60 mm

RU 4643-08

11,5 cm – 4½"

Spreizweite: 60 mm
Spread: 60 mm

RU 4643-11



ALM



scharf
sharp



stumpf
blunt

7 cm – 2¾"	RU 4650-07	RU 4651-07
10 cm – 4"	–	RU 4651-10



HEISS



scharf
sharp



stumpf
blunt

	10 cm – 4"	
RU 4655-00	RU 4655-10	

Wundspreizer Self-retaining Retractors

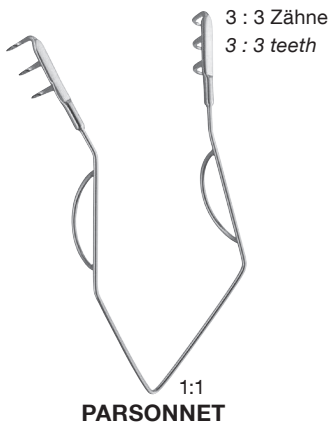

Größe Size	Epicardial Wundspreizer Epicardial retractors	
25 mm	Spreizweite: 15 mm Spread: 15 mm	RU 4660-01
33 mm	Spreizweite: 19 mm Spread: 19 mm	RU 4660-02
38 mm	Spreizweite: 24 mm Spread: 24 mm	RU 4660-03
52 mm	Spreizweite: 32 mm Spread: 32 mm	RU 4660-04



scharf
sharp



stumpf
blunt

10 cm – 4"

Spreizweite: 45 mm Spread: 45 mm	RU 4680-10	RU 4681-10
-------------------------------------	-------------------	-------------------

Wundspreizer Self-retaining Retractors

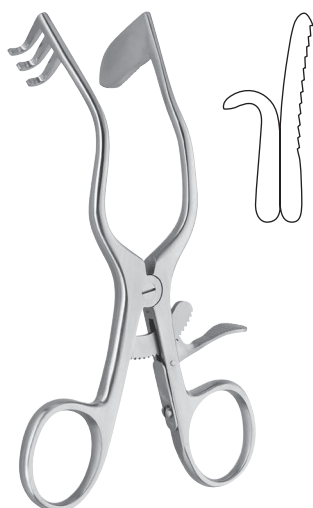

PERKINS

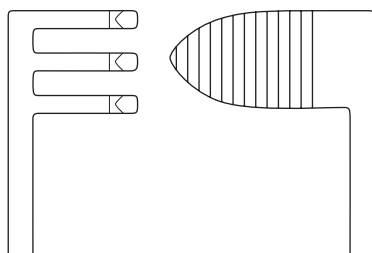

volles Blatt rechts,
scharf gezahnt
*solid blade right,
sharp serrated*

13 cm – 5"

RU 4688-01

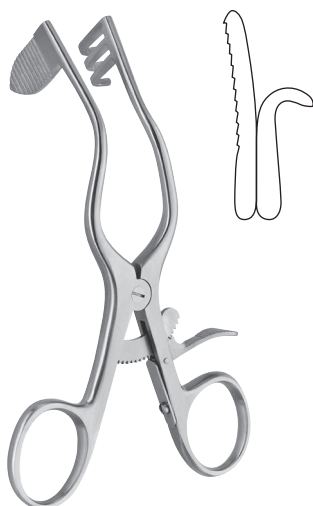

PERKINS

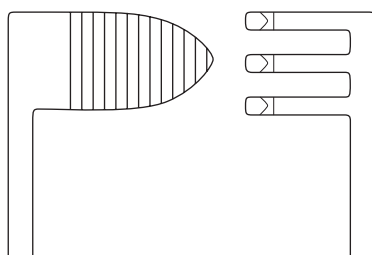

volles Blatt links,
scharf gezahnt
*solid blade left,
sharp serrated*

13 cm – 5"

RU 4688-02

Wundspreizer Self-retaining Retractors

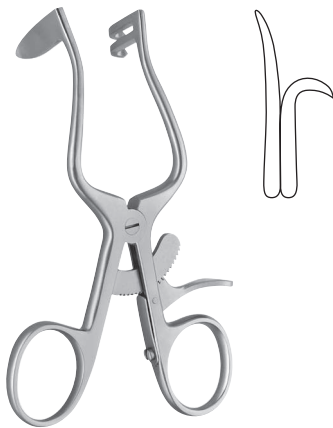

PLESTER

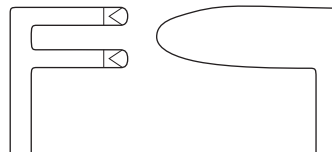

Spreizweite: 55 mm
Spread: 55 mm

Blatt links voll
Blatt rechts 2 Zähne, scharf
Blade left solid, sharp
Blade left 2 teeth, sharp

11 cm – 4¼"

RU 4690-01



PLESTER

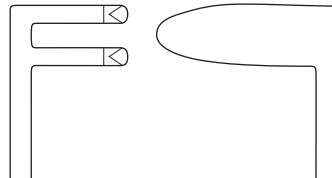

Spreizweite: 55 mm
Spread: 55 mm

Blatt rechts voll
Blatt links 2 Zähne, scharf
Blade right solid, sharp
Blade left 2 teeth, sharp

11 cm – 4¼"

RU 4690-02

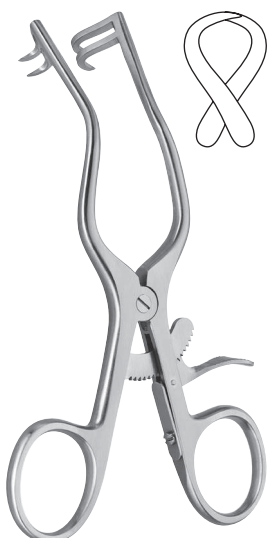

PLESTER

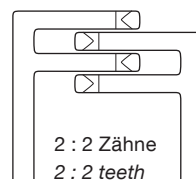

Spreizweite: 60 mm
Spread: 60 mm

scharf stumpf
sharp blunt

13 cm – 5"

RU 4691-01 | **RU 4691-02**

Wundspreizer Self-retaining Retractors



FISH

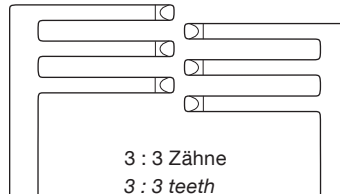

3 : 3 Zähne
3 : 3 teeth

stumpf
blunt

17 cm – 6¾"

RU 4694-11



WEITLANER

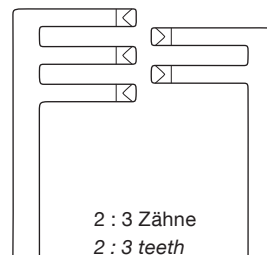

2 : 3 Zähne
2 : 3 teeth

scharf
sharp

stumpf
blunt

halbscharf
semi-sharp

10,5 cm – 4¼"

RU 4700-10

RU 4701-10

RU 4702-10



WEITLANER

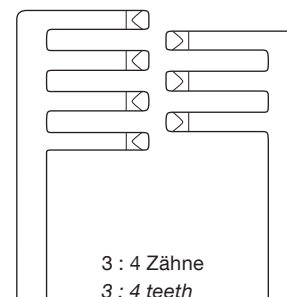

3 : 4 Zähne
3 : 4 teeth

scharf
sharp

stumpf
blunt

halbscharf
semi-sharp

13 cm – 5"

RU 4700-13

RU 4701-13

RU 4702-13

16,5 cm – 6½"

RU 4700-16

RU 4701-16

RU 4702-16

Wundspreizer Self-retaining Retractors

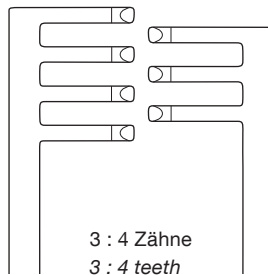
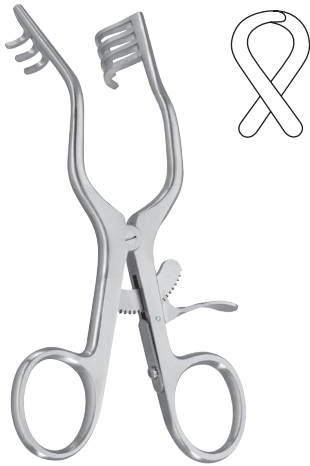

3 : 4 Zähne
3 : 4 teeth

stumpf
blunt

14 cm – 5½"

RU 4709-10

JEFFERSEN

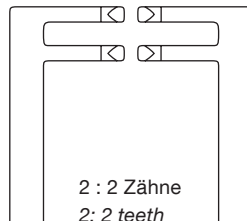
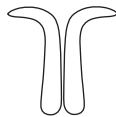
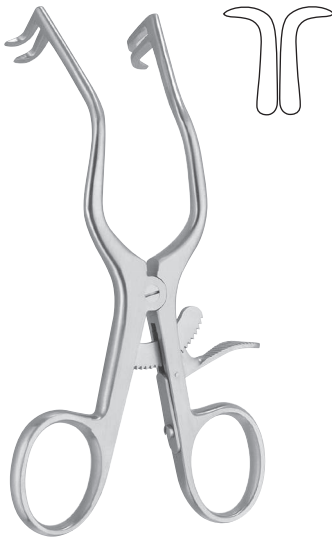

2 : 2 Zähne
2 : 2 teeth

scharf
sharp

14 cm – 5½"

RU 4709-20

MOLLISON

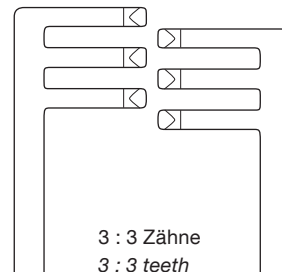
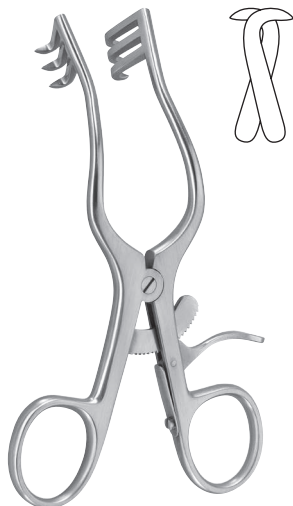

3 : 3 Zähne
3 : 3 teeth

scharf
sharp

stumpf
blunt

13 cm – 5"

Spreizweite: 45 mm
Spread: 45 mm

RU 4710-13

RU 4711-13

16,5 cm – 6½"

Spreizweite: 75 mm
Spread: 75 mm

RU 4710-16

RU 4711-16

WEITLANER-WULLSTEIN

Wundspreizer
Self-retaining Retractors

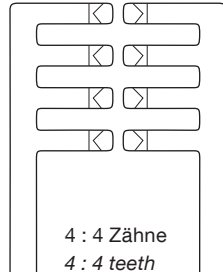

4 : 4 Zähne
4 : 4 teeth

scharf
sharp

15 cm – 6"

RU 4714-15

MOLLISON

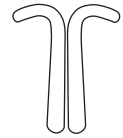

stumpf
blunt

14 cm – 5½"

RU 4715-14

CLOWARD

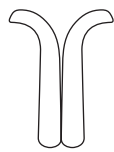

stumpf
blunt

16 cm – 6¼"

RU 4716-16

**TÜBINGER MODELL
TUEBINGEN PATTERN**



MAYO-ADAMS

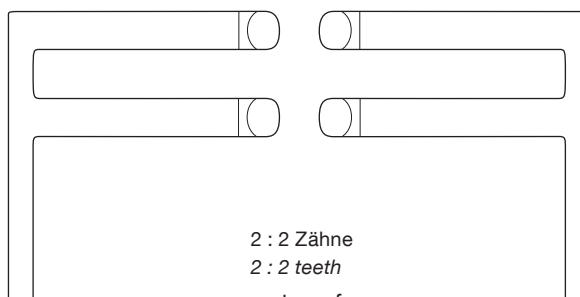

2 : 2 Zähne
2 : 2 teeth
stumpf
blunt

17 cm – 6¾"

RU 4755-17

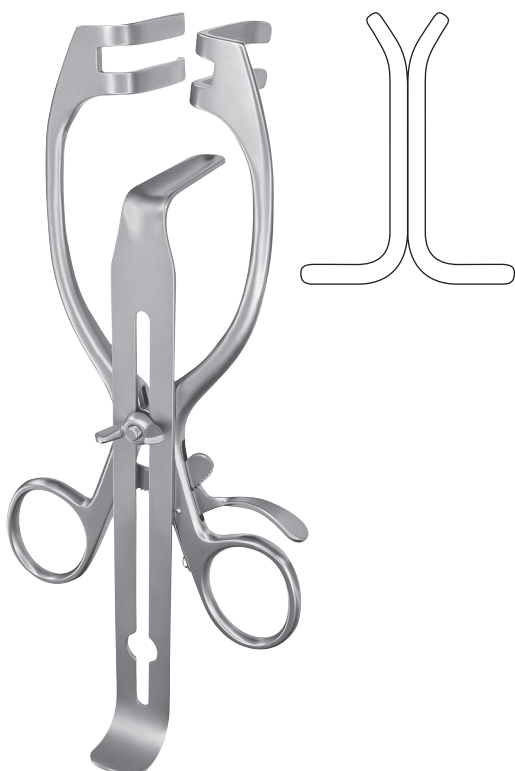

MAYO-ADAMS

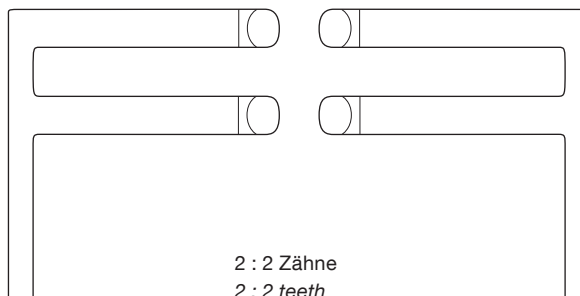

2 : 2 Zähne
2 : 2 teeth
stumpf
blunt

17 cm – 6¾"

RU 4756-17

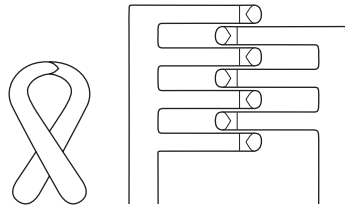

scharf
sharp

Wundsperrer komplett, bestehend aus:
Retractor complete, consisting of:

RU 4718-00

Sperrer
Retractor

3 Mittelvalven (RU 4718-19, -25, -32)

3 Central blades (RU 4718-19, -25, -32)

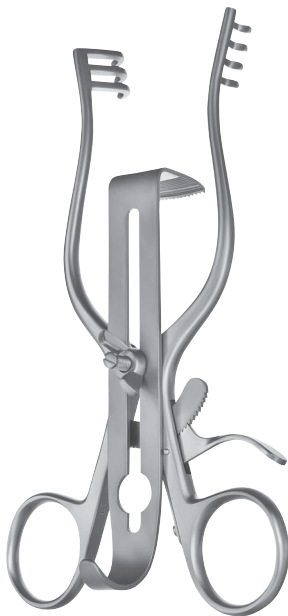

HENLEY

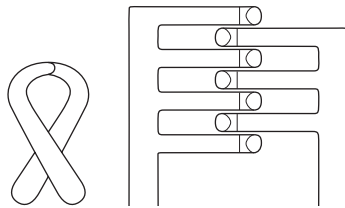

stumpf
blunt

Wundsperrer komplett, bestehend aus:
Retractor complete, consisting of:

RU 4718-01

Sperrer
Retractor

3 Mittelvalven (RU 4718-19, -25, -32)

3 Central blades (RU 4718-19, -25, -32)

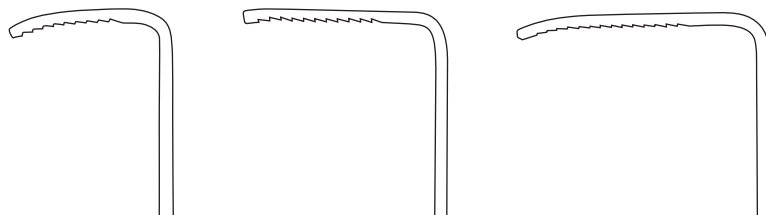

Mittelvalven
Central blades

19 x 16 mm	25 x 16 mm	32 x 16 mm
RU 4718-19	RU 4718-25	RU 4718-32

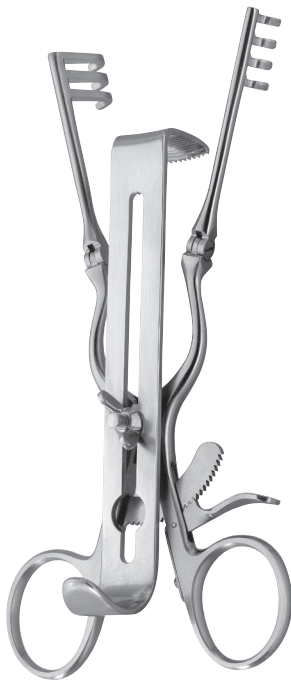

HENLEY

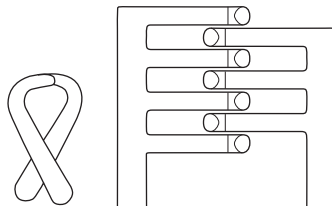

Standard

Sperrer, allein 17 cm – 6¾" <i>Retractor, only 17 cm – 6¾"</i>	RU 4719-17
---	-------------------

Wundsperrer komplett, bestehend aus: <i>Retractor complete, consisting of:</i>	RU 4719-20
---	-------------------

Sperrer allein (RU 4719-17)
Retractor only (RU 4719-17)
3 Mittelvalven (RU 4719-21, -22, -23)
3 Central blades (RU 4719-21, -22, -23)

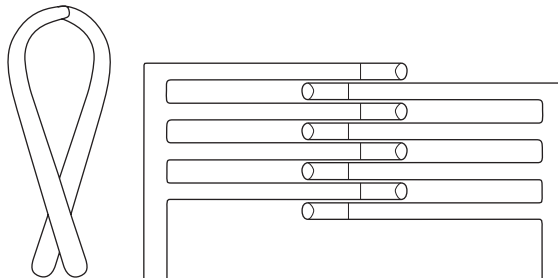

**Tiefes Modell
Deep Type**

Sperrer, allein 17 cm – 6¾" <i>Retractor, only 17 cm – 6¾"</i>	RU 4719-27
---	-------------------

Wundsperrer komplett, bestehend aus: <i>Retractor complete, consisting of:</i>	RU 4719-30
---	-------------------

Sperrer allein (RU 4719-27)
Retractor only (RU 4719-27)
3 Mittelvalven (RU 4719-21, -22, -23)
3 Central blades (RU 4719-21, -22, -23)

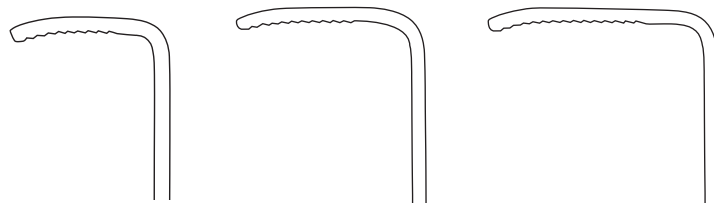

**Mittelvalven
Central blades**

Fig. 1	Fig. 2	Fig. 3
20 x 16 mm	25 x 16 mm	30 x 16 mm
RU 4719-21	RU 4719-22	RU 4719-23

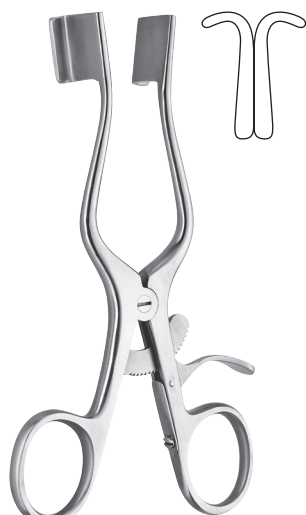

WEITLANER-BABY

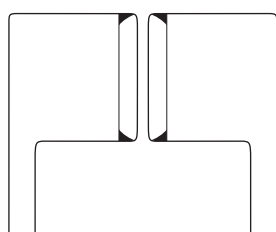

stumpf
blunt

13 cm – 5"

RU 4719-13



MILLIGAN

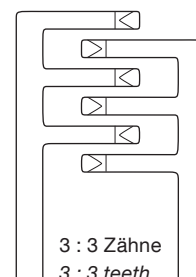

scharf
sharp

stumpf
blunt

13 cm – 5"

RU 4720-13

RU 4721-13



CONE (ADSON-BABY)

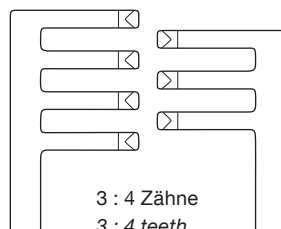

scharf
sharp

stumpf
blunt

3 : 4 Zähne
3 : 4 teeth

14 cm – 5½"

RU 4722-13

RU 4723-13

16 cm – 6¼"

RU 4722-16

RU 4723-16

Wundspreizer Self-retaining Retractors



WEITLANER

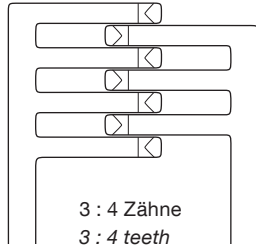

scharf stumpf
sharp blunt

20 cm – 8"

RU 4724-20 | **RU 4725-20**

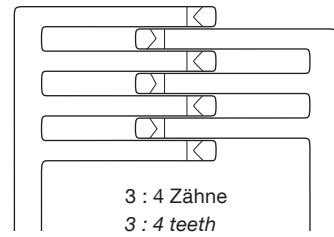

scharf stumpf
sharp blunt

24 cm – 9½"

RU 4724-25 | **RU 4725-25**

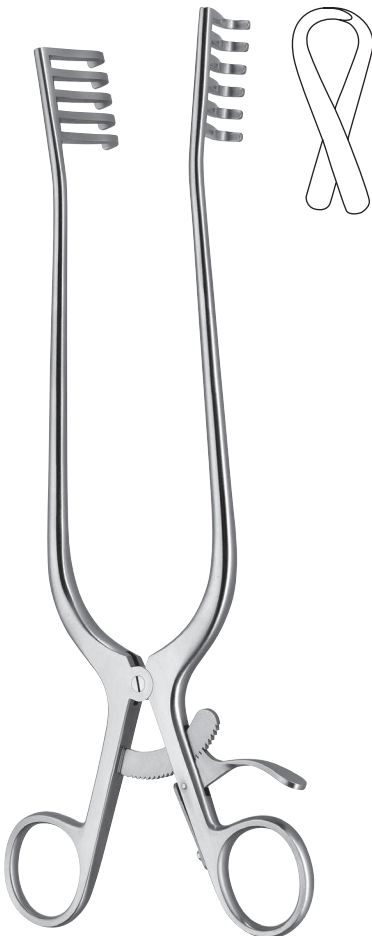

WEITLANER

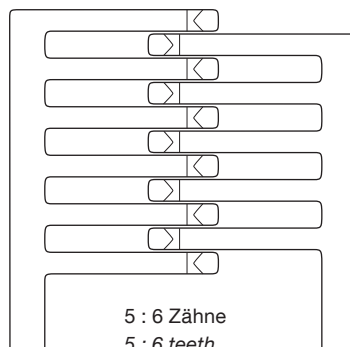

scharf stumpf
sharp blunt

25 cm – 10"

RU 4726-25 | **RU 4727-25**

Wundspreizer Self-retaining Retractors



ADSON

4 : 4 Zähne 4 : 4 teeth	
scharf sharp	stumpf blunt
19,5 cm – 7¾"	
RU 4728-20	RU 4729-20



ANDERSON-ADSON

scharf sharp	stumpf blunt
20 cm – 8"	
RU 4730-20	RU 4731-20

Wundspreizer Self-retaining Retractors

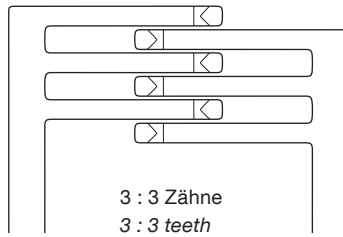

3 : 3 Zähne
3 : 3 teeth
scharf
sharp

24 cm – 9½"

RU 4732-24

ADSON

1:3

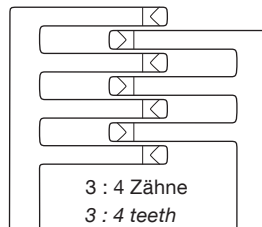

3 : 4 Zähne
3 : 4 teeth

scharf stumpf
sharp blunt

21 cm – 8¼"

RU 4734-20 | **RU 4735-20**

CONE

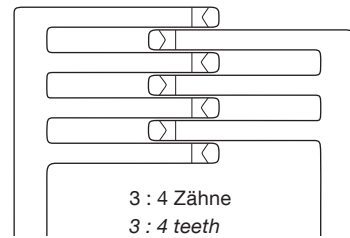

3 : 4 Zähne
3 : 4 teeth

scharf stumpf
sharp blunt

25 cm – 10"

RU 4734-26 | **RU 4735-26**

Wundspreizer Self-retaining Retractors



TRAVERS

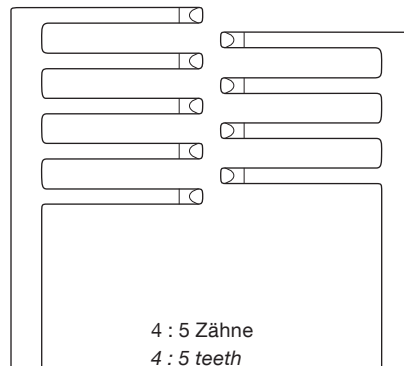
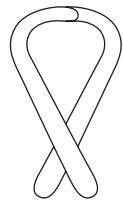

4 : 5 Zähne
4 : 5 teeth

stumpf
blunt

21 cm – 8¼"

RU 4738-21

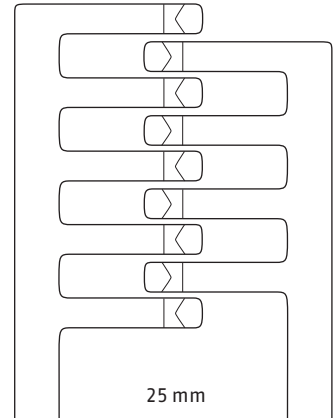

25 mm

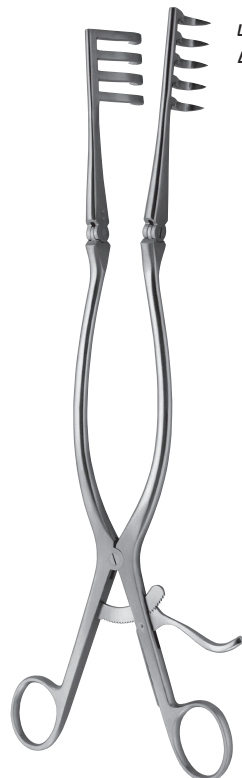

4 : 5 Zähne
4 : 5 teeth

1:3

BECKMANN-ADSON

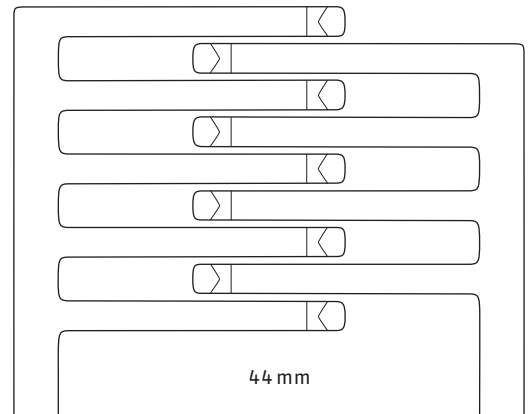

44 mm

scharf
sharp

stumpf
blunt

halbscharf
semi-sharp

31 cm – 12¼"

25mm	RU 4739-01	RU 4739-11	RU 4739-21
44mm	RU 4739-02	RU 4739-12	RU 4739-22

Wundspreizer Self-retaining Retractors

3 : 4 Zähne
3 : 4 teeth

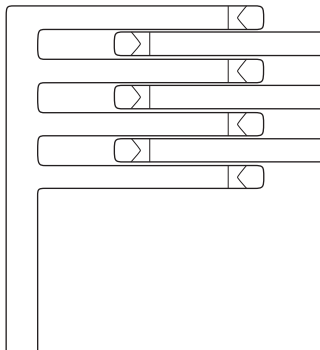

scharf
sharp stumpf
blunt

21 cm – 8¼"

RU 4740-27	RU 4741-27
------------	------------

ADSON



5 : 6 Zähne
5 : 6 teeth

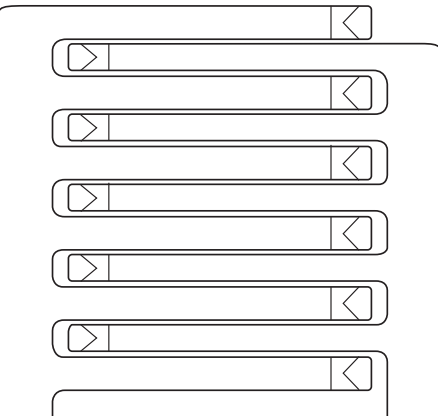

scharf
sharp stumpf
blunt

27 cm – 10½"

RU 4740-51	RU 4741-51
------------	------------

ADSON 1:3

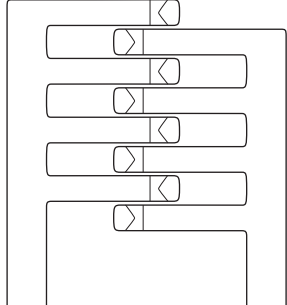

4 : 4 Zähne
4 : 4 teeth

4 : 4 Zähne
4 : 4 teeth

scharf
sharp stumpf
blunt halbscharf
semisharp

31 cm – 12¼"

RU 4742-31	RU 4743-31	RU 4743-41
------------	------------	------------

**BECKMANN-ADSON
(STANDARD)** 1:3

Wundspreizer Self-retaining Retractors

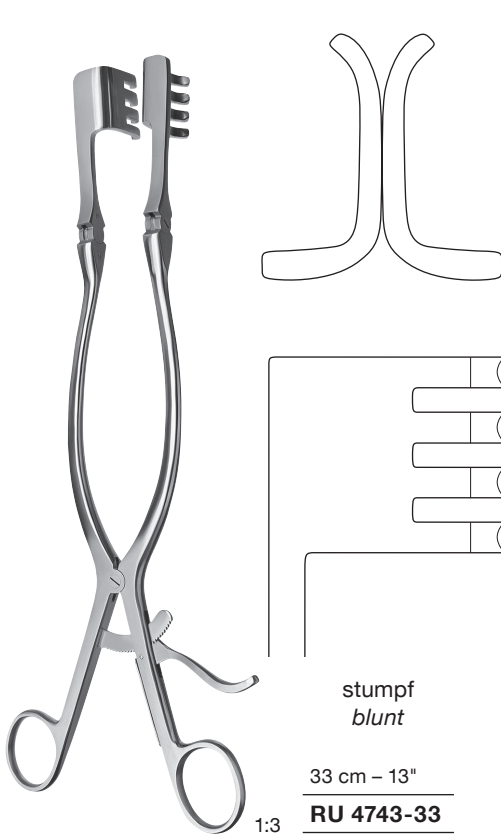

ADSON

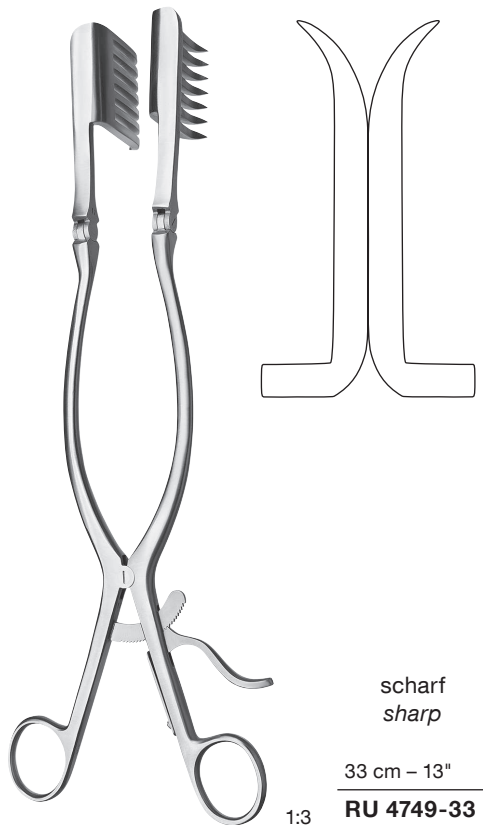
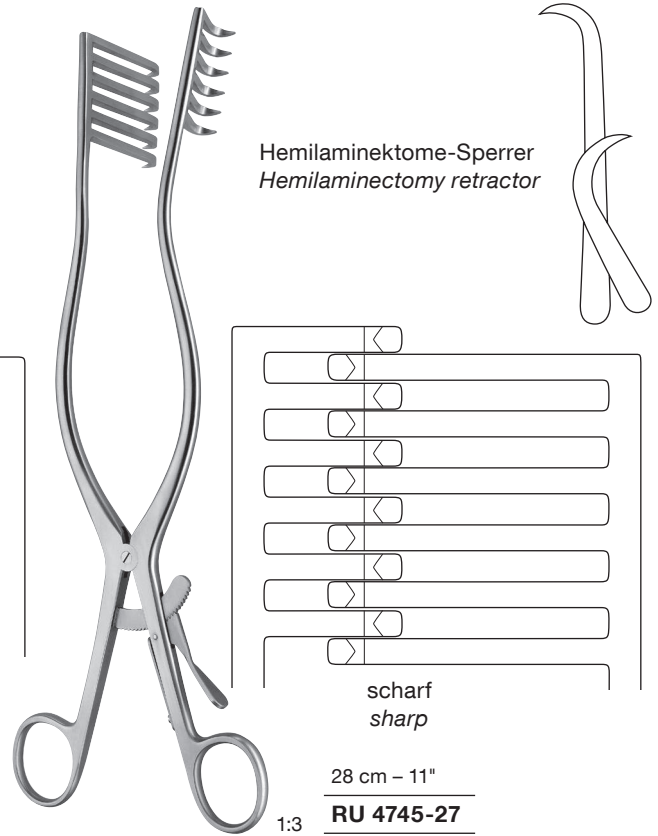

BECKMANN-EATON

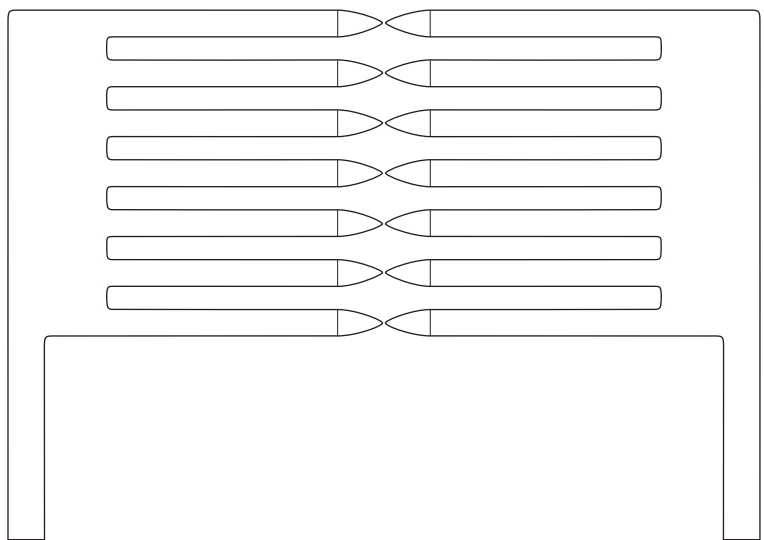



Wundspreizer
Self-retaining Retractors



MARHAM-MEYERDING

18 cm – 7"

RU 4765-01

RU 4765-02



RIGBY

19 cm – 7½"

RU 4767-19

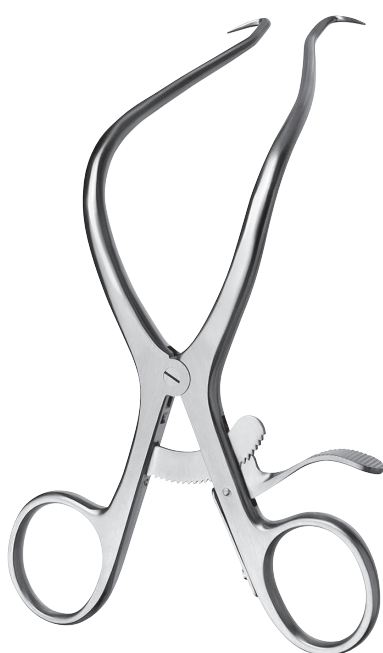

DE BAKEY

12 cm – 4¾"

RU 4768-12

17 cm – 6¾"

RU 4768-17

Bauchdeckenhalter Abdominal Retractors



COLLIN

Sperrer allein,
Spreizweite: 100 mm
*Retractor only,
spread: 100 mm*

RU 4750-50

Bauchdeckenhalter komplett mit
einem Paar Blätter RU 4750-51
*Abdominal retractor complete with
one pair of blades RU 4750-51*

RU 4750-00

Blätter seitlich, 1 Paar (38 x 60 mm)
Blades lateral, 1 pair (38 x 60 mm)

RU 4750-51



BABY-COLLIN

Bauchdeckenhalter (Spreizweite: 80 mm) komplett mit
2 Paar Blätter (28 x 42 mm, 18 x 42 mm)
*Abdominal retractor (spread: 80 mm) complete with
two pairs of blades (28 x 42 mm, 18 x 42 mm)*

RU 4751-00

Blätter seitlich, 1 Paar (18 x 42 mm)
Blades lateral, 1 pair (18 x 42 mm)

RU 4751-51

Blätter seitlich, 1 Paar (28 x 42 mm)
Blades lateral, 1 pair (28 x 42 mm)

RU 4751-52



COLLIN

Fig. 1

Sperrer allein, Spreizweite: 110 mm <i>Retractor only, spread: 110 mm</i>	RU 4752-50
Bauchdeckenhalter komplett, bestehend aus: <i>Abdominal retractor complete, consisting of:</i>	RU 4752-00
Sperrer allein (RU 4752-50) <i>Retractor only (RU 4752-50)</i>	
1 Paar Blätter seitlich, 38 x 62 mm (RU 4752-51) <i>1 pair of blades lateral, 38 x 62 mm (RU 4752-51)</i>	
1 Mittelblatt, 55 x 55 mm (RU 4752-55) <i>1 Central blade, 55 x 55 mm (RU 4752-55)</i>	

Fig. 2

Sperrer allein, Spreizweite: 110 mm <i>Retractor only, spread: 110 mm</i>	RU 4754-50
Bauchdeckenhalter komplett, bestehend aus: <i>Abdominal retractor complete, consisting of:</i>	RU 4754-00
Sperrer allein (RU 4754-50) <i>Retractor only (RU 4754-50)</i>	
1 Paar Blätter seitlich, 38 x 80 mm (RU 4754-51) <i>1 pair of blades lateral, 38 x 80 mm (RU 4754-51)</i>	

Fig. 3

Sperrer allein, Spreizweite: 110 mm <i>Retractor only, spread: 110 mm</i>	RU 4754-60
Bauchdeckenhalter komplett, bestehend aus: <i>Abdominal retractor complete, consisting of:</i>	RU 4754-10
Sperrer allein (RU 4754-60) <i>Retractor only (RU 4754-60)</i>	
1 Paar Blätter seitlich, 38 x 100 mm (RU 4754-61) <i>1 pair of blades lateral, 38 x 100 mm (RU 4754-61)</i>	
1 Mittelblatt, 55 x 75 mm (RU 4754-65) <i>1 Central blade, 55 x 75 mm (RU 4754-65)</i>	

Bauchdeckenhalter Abdominal Retractors

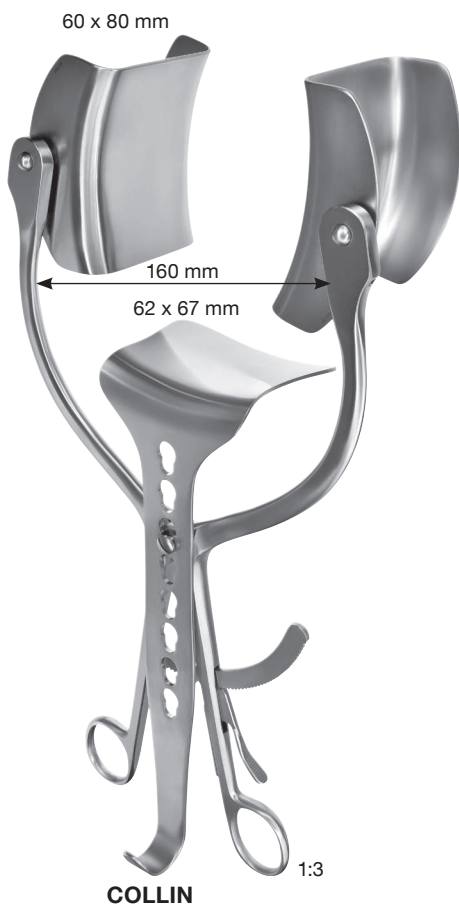

Sperrer allein
Retractor only

RU 4754-76

Bauchdeckenhalter komplett, bestehend aus:
Abdominal retractor complete, consisting of:

RU 4754-70

Sperrer allein (RU 4754-76)
Retractor only (RU 4754-76)

1 Paar Blätter seitlich, 60 x 80 mm (RU 4754-71)
1 pair of blades lateral, 60 x 80 mm (RU 4754-71)

1 Mittelblatt, 62 x 67 mm (RU 4754-75)
1 Central blade, 62 x 67 mm (RU 4754-75)

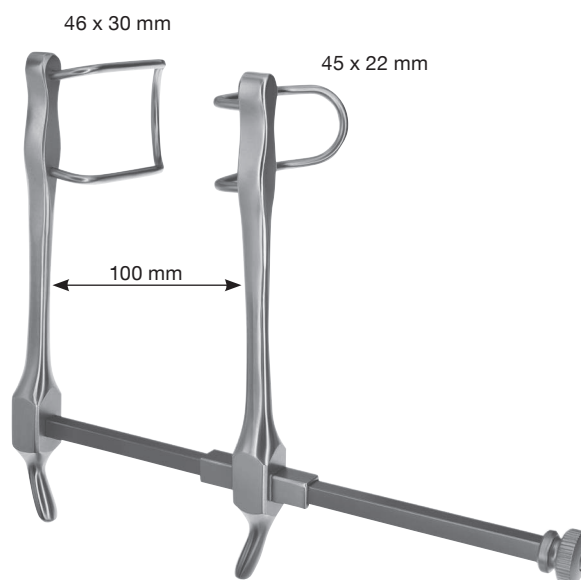

Fig. 1

Sperrer allein <i>Retractor only</i>	RU 4758-11
Bauchdeckenhalter komplett, bestehend aus: <i>Abdominal retractor complete, consisting of:</i>	RU 4758-01
Sperrer allein (RU 4758-11) <i>Retractor only (RU 4758-11)</i> 1 Paar Blätter seitlich, 60 x 80 mm (RU 4758-21) <i>1 pair of blades lateral, 60 x 80 mm (RU 4758-21)</i> 1 Mittelblatt, 53 x 70 mm (RU 4758-31) <i>1 Central blade, 53 x 70 mm (RU 4758-31)</i>	

Fig. 2

Sperrer allein <i>Retractor only</i>	RU 4758-11
Bauchdeckenhalter komplett, bestehend aus: <i>Abdominal retractor complete, consisting of:</i>	RU 4758-02
Sperrer allein (RU 4758-11) <i>Retractor only (RU 4758-11)</i> 1 Paar Blätter seitlich, 72 x 85 mm (RU 4758-22) <i>1 pair of blades lateral, 72 x 85 mm (RU 4758-22)</i> 1 Mittelblatt, 80 x 90 mm (RU 4758-32) <i>1 Central blade, 80 x 90 mm (RU 4758-32)</i>	



GOSSET
RU 4769-00

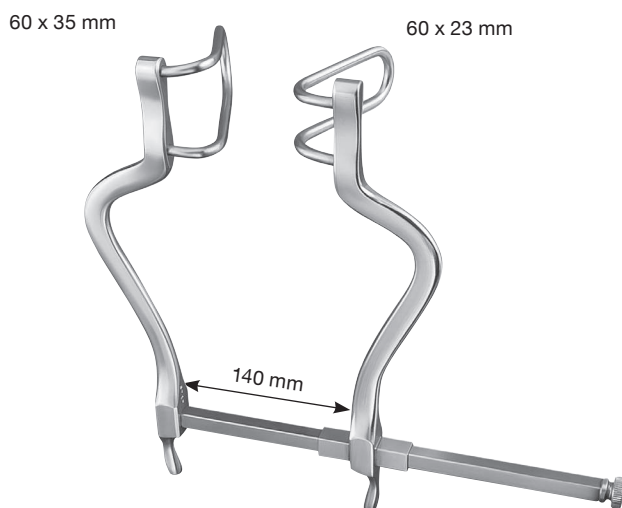

GOSSET
RU 4770-02

Bauchdeckenhalter Abdominal Retractors



GOSSET

Sperrer allein
Retractor only

RU 4771-11

Bauchdeckenhalter komplett, bestehend aus:
Abdominal retractor complete, consisting of:

RU 4771-00

Sperrer allein (RU 4771-11)
Retractor only (RU 4771-11)

1 Mittelblatt, 65 x 60 mm (RU 4771-21)

1 Central blade, 65 x 60 mm (RU 4771-21)



FRAZIER

RU 4774-00

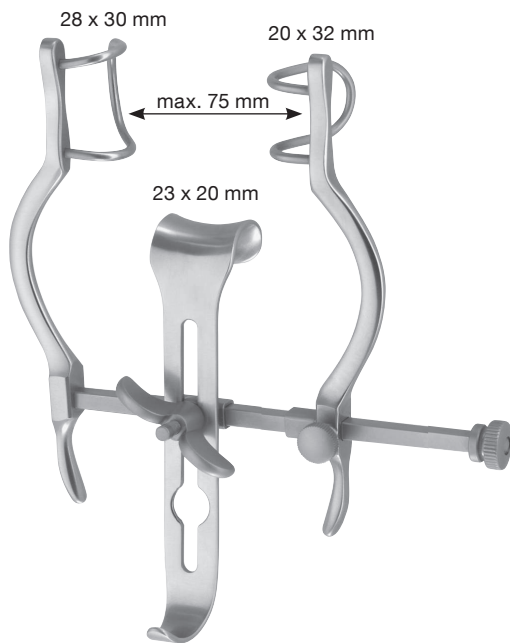

BABY-BALFOUR

Sperrer allein,
Spreizweite: 75 mm
Retractor only,
Spread: 75 mm

RU 4798-11

Sperrer komplett, bestehend aus:
Retractor complete, consisting of:

RU 4798-00

Sperrer allein (RU 4798-11)
Retractor only (RU 4798-11)
Mittelblatt (RU 4798-21)
Central blade (RU 4798-21)



BALFOUR

Sperrer allein,
Spreizweite: 150 mm
Retractor only,
Spread: 150 mm

RU 4800-11

Sperrer komplett, bestehend aus:
Retractor complete, consisting of:

RU 4800-00

Sperrer allein (RU 4800-11)
Retractor only (RU 4800-11)
Mittelblatt (RU 4800-21)
Central blade (RU 4800-21)

Bauchdeckenhalter Abdominal Retractors

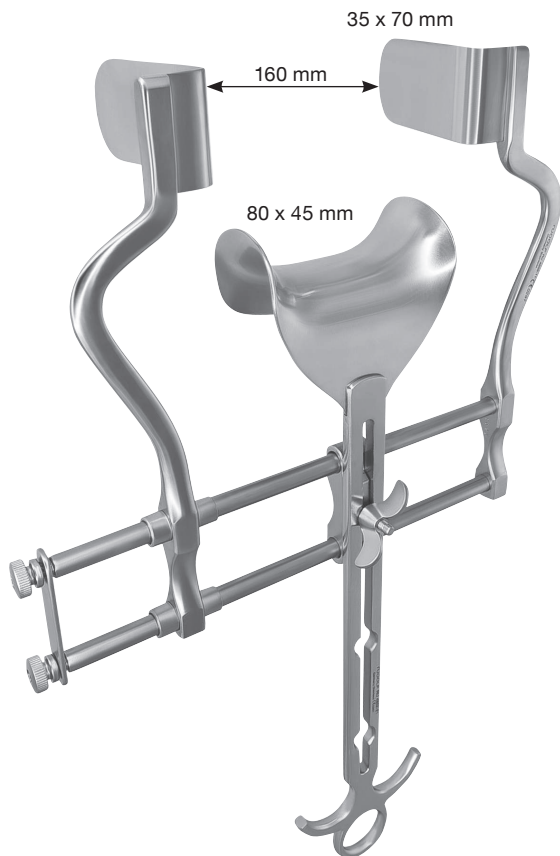

BALFOUR

Sperrer allein,
Spreizweite: 160 mm
*Retractor only,
spread: 160 mm*

RU 4802-11

Sperrer komplett, bestehend aus:
Retractor complete, consisting of:

RU 4802-00

Sperrer allein (RU 4802-11)
Retractor only (RU 4802-11)
Mittelblatt (RU 4802-21)
Central blade (RU 4802-21)

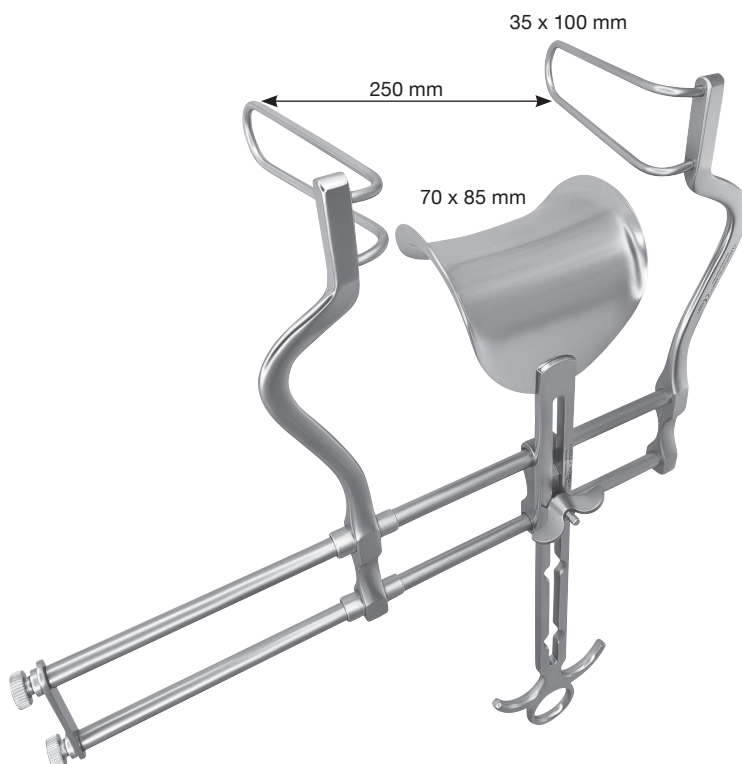

BALFOUR

Sperrer allein,
Spreizweite: 250 mm
*Retractor only,
spread: 250 mm*

RU 4804-11

Sperrer komplett, bestehend aus:
Retractor complete, consisting of:

RU 4804-00

Sperrer allein (RU 4804-11)
Retractor only (RU 4804-11)
Mittelblatt (RU 4804-21)
Central blade (RU 4804-21)

Bauchdeckenhalter Abdominal Retractors

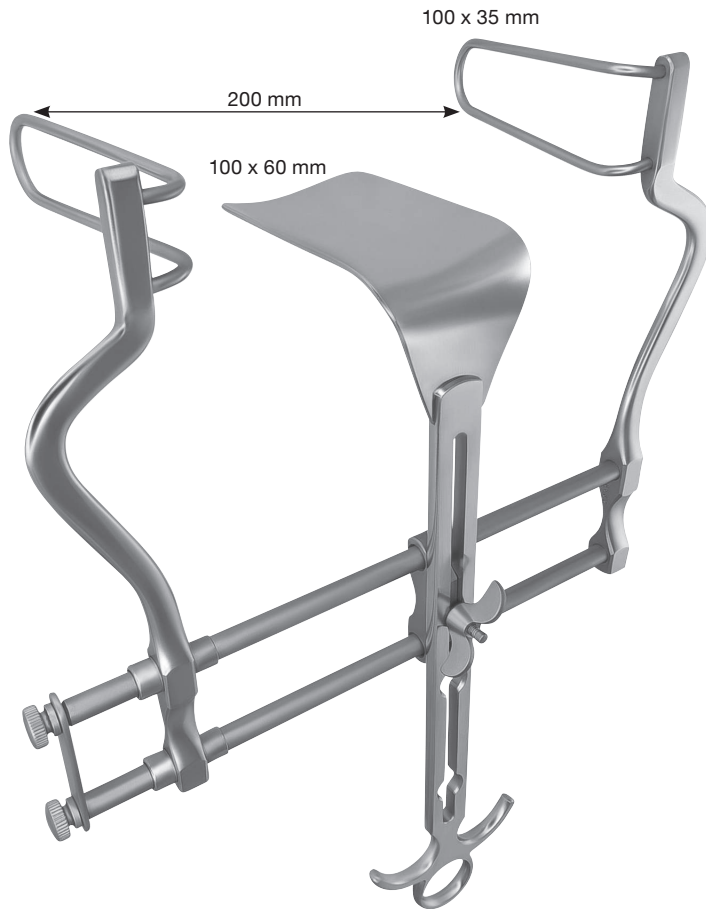

BALFOUR

Sperrer allein, Spreizweite: 200 mm <i>Retractor only, Spread: 200 mm</i>	RU 4806-11
Sperrer komplett, bestehend aus: <i>Retractor complete, consisting of:</i>	RU 4806-00
Sperrer allein (RU 4806-11) <i>Retractor only (RU 4806-11)</i> Mittelblatt (RU 4806-21) <i>Central blade (RU 4806-21)</i>	



BALFOUR USA-MODELL BALFOUR USA-PATTERN

Sperrer allein <i>Retractor only</i>	RU 4807-11
Sperrer komplett, bestehend aus: <i>Retractor complete, consisting of:</i>	RU 4807-00
Sperrer allein (RU 4807-11) <i>Retractor only (RU 4807-11)</i> 2 Blätter seitlich, 60 mm (RU 4807-31) <i>2 Blades lateral, 60 mm (RU 4807-31)</i> 2 Blätter seitlich, 80 mm (RU 4807-32) <i>2 Blades lateral, 80 mm (RU 4807-32)</i> 1 Mittelblatt, 45 x 68 mm (RU 4807-21) <i>1 Central blade, 45 x 68 mm (RU 4807-21)</i> 1 Mittelblatt, 68 x 85 mm (RU 4807-22) <i>1 Central blade, 68 x 85 mm (RU 4807-22)</i>	



SEMM

Bauchdeckenhalter komplett,
bestehend aus:
*Abdominal retractor complete,
consisting of:*

RU 4810-00

Rahmen (RU 4810-10)
Frame (RU 4810-10)

2 Blätter (RU 4810-01)
2 Blades (RU 4810-01)

1 Blätter (RU 4810-02)
1 Blades (RU 4810-02)

1 Blätter (RU 4810-03)
1 Blades (RU 4810-03)

1 Blätter (RU 4810-04)
1 Blades (RU 4810-04)

1 Blätter (RU 4810-05)
1 Blades (RU 4810-05)



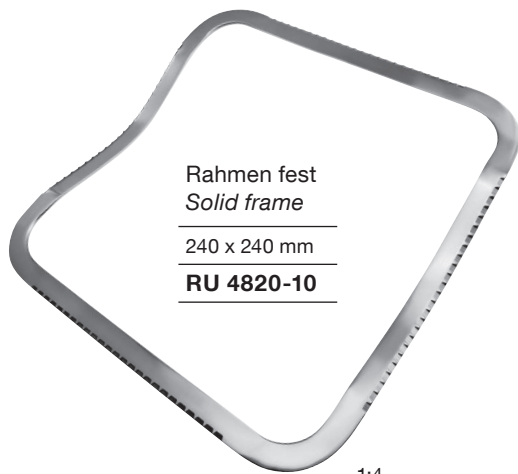

Rahmen fest
Solid frame
240 x 240 mm
RU 4820-10

1:4

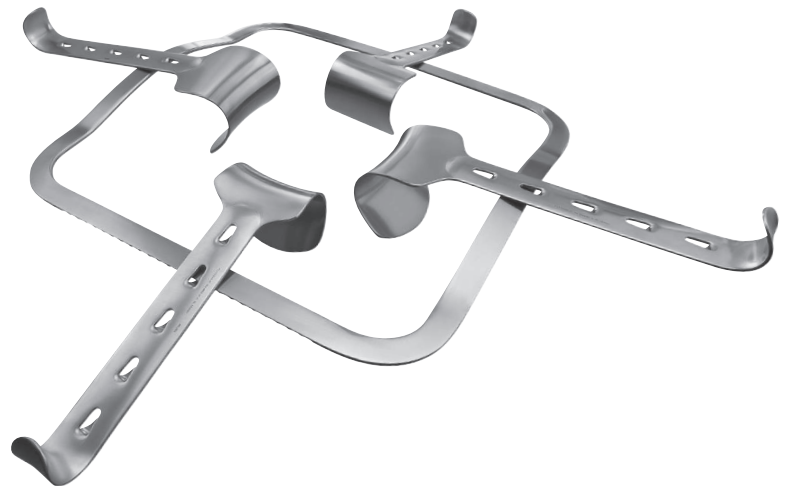

KIRSCHNER

Bauchdeckenhalter komplett, bestehend aus:
Abdominal retractor complete, consisting of:

RU 4820-00

Rahmen fest (RU 4820-10)
Solid frame (RU 4820-10)

2 Blätter, 40 x 55 mm (RU 4822-01)
2 Blades, 40 x 55 mm (RU 4822-01)

2 Blätter, 50 x 65 mm (RU 4822-02)
2 Blades, 50 x 65 mm (RU 4822-02)



Rahmen zusammenlegbar
Foldable frame
240 x 240 mm
RU 4821-10

1:4

KIRSCHNER

Bauchdeckenhalter komplett, bestehend aus:
Abdominal retractor complete, consisting of:

RU 4821-00

Rahmen zusammenlegbar (RU 4821-10)
Foldable frame (RU 4821-10)

2 Blätter, 40 x 55 mm (RU 4822-01)
2 Blades, 40 x 55 mm (RU 4822-01)

2 Blätter, 50 x 65 mm (RU 4822-02)
2 Blades, 50 x 65 mm (RU 4822-02)



1:3

	Blätter <i>Blades</i>
40 x 55 mm	RU 4822-01
50 x 65 mm	RU 4822-02
65 x 80 mm	RU 4822-03
80 x 80 mm	RU 4822-04
90 x 65 mm	RU 4822-05
90 x 90 mm	RU 4822-06



Rahmen
Frame

178 x 140 mm

RU 4826-10

DENIS-BROWN

Bauchdeckenhalter komplett, bestehend aus: <i>Abdominal retractor complete, consisting of:</i>	RU 4826-00
---	-------------------

Rahmen 178 x 140 mm (RU 4826-10)
Frame 178 x 140 mm (RU 4826-10)

2 Blätter, Fig. 1, 40 x 40 mm (RU 4828-01)
2 Blades, fig. 1, 40 x 40 mm (RU 4828-01)

2 Blätter, Fig. 2, 40 x 30 mm (RU 4828-02)
2 Blades, fig. 2, 40 x 30 mm (RU 4828-02)



1:3

40 x 40 mm

Blatt, Fig. 1
Blade, fig. 1

RU 4828-01



1:3

40 x 30 mm

Blatt, Fig. 2
Blade, fig. 2

RU 4828-02

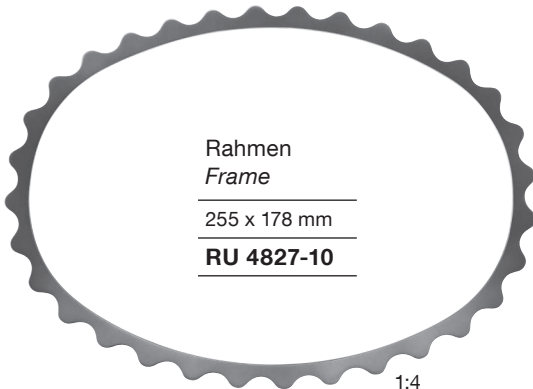

Rahmen
Frame

255 x 178 mm

RU 4827-10

1:4

DENIS-BROWN

Bauchdeckenhalter komplett, bestehend aus: <i>Abdominal retractor complete, consisting of:</i>	RU 4827-00
---	-------------------

Rahmen 255 x 178 mm (RU 4827-10)
Frame 255 x 178 mm (RU 4827-10)

2 Blätter, Fig. 1, 40 x 40 mm (RU 4828-01)
2 Blades, fig. 1, 40 x 40 mm (RU 4828-01)

2 Blätter, Fig. 2, 40 x 30 mm (RU 4828-02)
2 Blades, fig. 2, 40 x 30 mm (RU 4828-02)



1:3

40 x 40 mm

Blatt, Fig. 1
Blade, fig. 1

RU 4828-01



1:3

40 x 30 mm

Blatt, Fig. 2
Blade, fig. 2

RU 4828-02

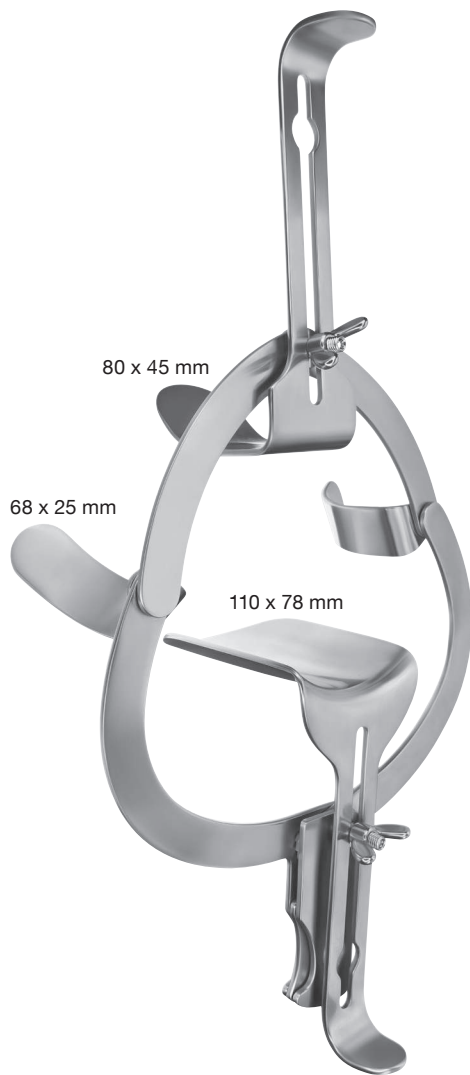

O'SULLIVAN-O'CONNOR

Bauchdeckenhalter komplett, bestehend aus: <i>Abdominal retractor complete, consisting of:</i>	RU 4829-00
---	-------------------

2 Mittelblätter, 80 x 45 mm (RU 4829-22)
2 *Central blades, 80 x 45 mm (RU 4829-22)*

1 Mittelblatt, 110 x 70 mm (RU 4829-23)
1 *Central blade, 110 x 70 mm (RU 4829-23)*



80 x 45 mm
RU 4829-22

110 x 70 mm
RU 4829-23

Bauchdeckenhalter Abdominal Retractors

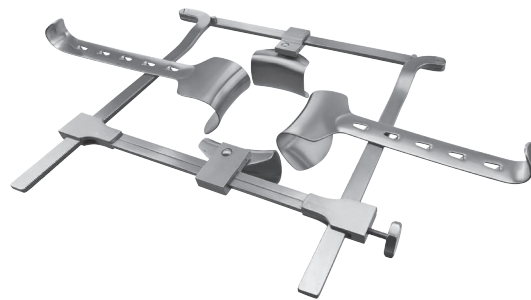

FRANZ

Bauchdeckenhalter komplett,
bestehend aus:

*Abdominal retractor complete,
consisting of:*

RU 4830-04

Rahmen zusammenlegbar (RU 4830-10)
Foldable frame (RU 4830-10)

2 Blätter, 38 x 60 mm (RU 4832-01)

2 Blades, 38 x 60 mm (RU 4832-01)

2 Blätter, 50 x 65 mm (RU 4833-01)

2 Blades, 50 x 65 mm (RU 4833-01)

FRANZ

Bauchdeckenhalter komplett,
bestehend aus:

*Abdominal retractor complete,
consisting of:*

RU 4830-08

Rahmen zusammenlegbar (RU 4830-10)
Foldable frame (RU 4830-10)

2 Blätter, 38 x 60 mm (RU 4832-01)

2 Blades, 38 x 60 mm (RU 4832-01)

2 Blätter, 50 x 65 mm (RU 4833-01)

2 Blades, 50 x 65 mm (RU 4833-01)

2 Blätter, 45 x 80 mm (RU 4832-02)

2 Blades, 45 x 80 mm (RU 4832-02)

2 Blätter, 60 x 85 mm (RU 4833-02)

2 Blades, 60 x 85 mm (RU 4833-02)

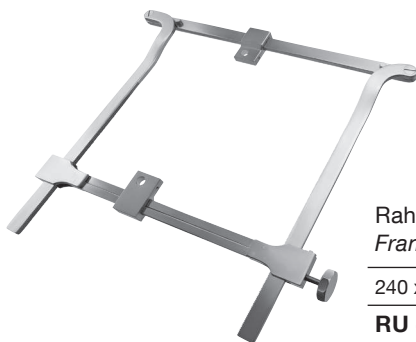

Rahmen
Frame

240 x 300 mm

RU 4830-10



1:3

Blätter
Blades

38 x 60 mm

RU 4832-01

45 x 80 mm

RU 4832-02



1:3

Blätter
Blades

50 x 65 mm

RU 4833-01

60 x 85 mm

RU 4833-02



Bauchdeckenhalter
Abdominal retractor

1:3

48 x 90 mm

RU 4834-01

48 x 105 mm

RU 4834-02

48 x 120 mm

RU 4834-03

48 x 135 mm

RU 4834-04

DOYEN

Bauchdeckenhalter
Abdominal Retractors

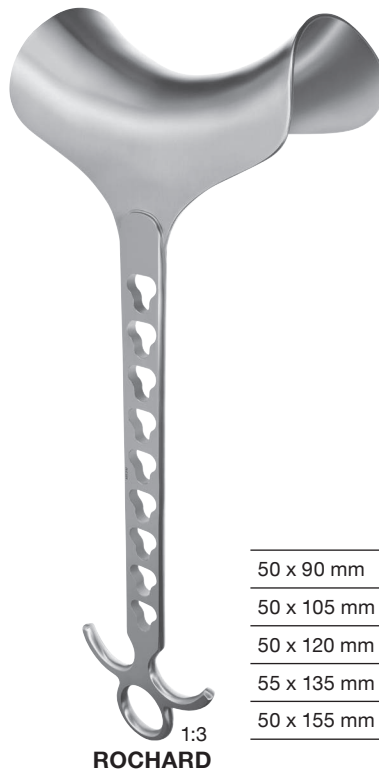
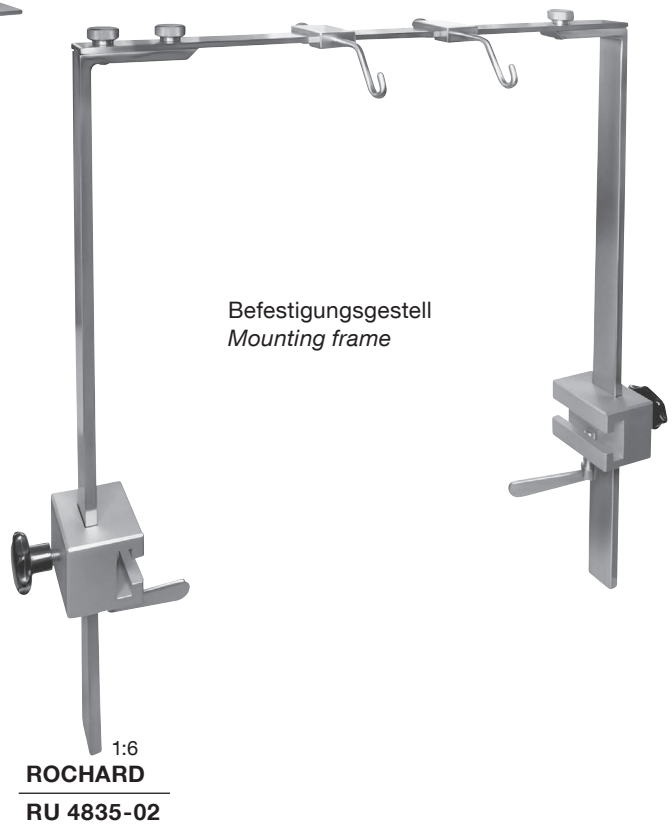

	Blätter Blades
50 x 90 mm	RU 4835-09
50 x 105 mm	RU 4835-10
50 x 120 mm	RU 4835-12
55 x 135 mm	RU 4835-13
50 x 155 mm	RU 4835-15

Trokare, Saug- und Spülinstrumente,
Sonden, Watteträger
Trocars, Suction and Irrigation Instruments,
Probes, Cotton Applicators



Trokare	<i>Trocars</i>	TS 1 - 2
Kanülen	<i>Cannulas</i>	TS 3 - 7
Saug-Raspatorien, Saug-Dissektoren	<i>Suction Raspatories, Suction Dissectors</i>	TS 8
Mikro-Saugkanülen	<i>Micro Suction Tubes</i>	TS 9
Katheterzangen	<i>Catheter Forceps</i>	TS 10
Spritzen	<i>Syringes</i>	TS 11
Luer-Lock Adapter	<i>Luer-Lock Adapter</i>	TS 12
Führungsnadeln	<i>Guide Needles</i>	TS 13
Sonden	<i>Probes</i>	TS 14 - 17
Watteträger	<i>Cotton Applicators</i>	TS 18 - 20

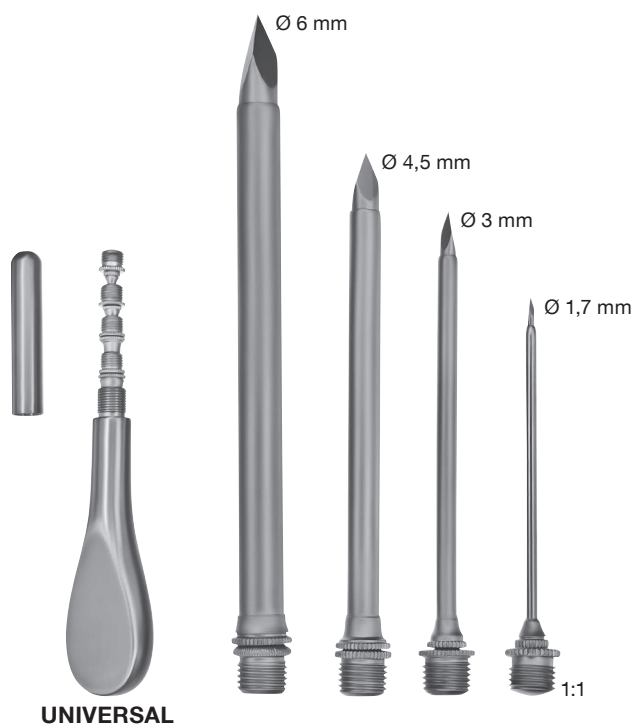

UNIVERSAL

Trokar-Set komplett, bestehend aus: <i>Trocar set complete, consisting of:</i>	RU 5212-04
---	-------------------

- 1 Griff, flach
1 Handle, flat
- 1 Trokar Ø 1,7 mm
1 Trocar Ø 1.7 mm
- 1 Trokar Ø 3 mm
1 Trocar Ø 3 mm
- 1 Trokar Ø 4,5 mm
1 Trocar Ø 4.5 mm
- 1 Trokar Ø 6 mm
1 Trocar Ø 6 mm

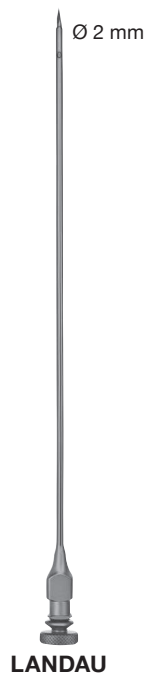

mit Luer-Lock Ansatz
with Luer-Lock hub

16 cm – 6¼"

RU 5220-16



14 cm – 5½"

RU 5232-16



Ø mm	15 cm – 6"
4	RU 5250-40
4,6	RU 5250-46
5,5	RU 5250-55
6,5	RU 5250-65

Ø 10 mm mit zentraler Bohrung Ø 2 mm
Ø 10 mm with central hole Ø 2 mm



27 cm – 10½"

RU 5260-27

1:3

YANKAUER-STANDARD



Ø 5 mm



22,5 cm – 8¾"

RU 5265-00

1:3

ANDREW-PYNCHON



Ø 10 mm

22 cm – 8¾"

RU 5280-22

1:3

POOLE



Ø 8 mm

22 cm – 8¾"

RU 5281-22

1:3

POOLE

Trokare, Saug- und Spülinstrumente,
Sonden, Watteträger
Trocars, Suction and Irrigation Instruments,
Probes, Cotton Applicators

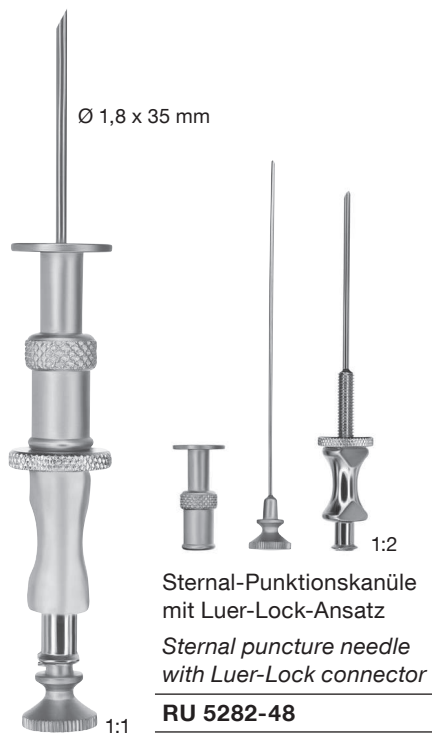

KLIMA-ROSEGGER

isoliert, mit Saugunterbrecher und Mandrel
insulated, with cut-off and stylet



FERGUSSON

		Arbeitslänge <i>Working length</i>
Ø mm	Charr./Fr.	90 mm – 3½"
4	12	RU 6421-34

		Arbeitslänge <i>Working length</i>		
Ø mm	Charr./Fr.	90 mm – 3½"	110 mm – 4¼"	130 mm – 5"
1,5	5	RU 6420-05	RU 6420-16	RU 6420-25
2	6	RU 6420-06	RU 6420-17	RU 6420-26
2,3	7	RU 6420-07	RU 6420-18	RU 6420-27
2,5	8	RU 6420-08	RU 6420-19	RU 6420-28
3	9	RU 6420-09	RU 6420-20	RU 6420-29
3,3	10	RU 6420-10	RU 6420-21	RU 6420-30
3,5	11	RU 6420-11	RU 6420-22	RU 6420-31
4	12	RU 6420-12	RU 6420-23	RU 6420-32
5	15	RU 6420-15	RU 6420-24	RU 6420-33

mit Saugunterbrecher und Mandrel
with cut-off and stylet



FRAZIER (FERGUSSON)

		Arbeitslänge <i>Working length</i>	
Ø mm	Charr./Fr.	150 mm – 6"	190 mm – 7½"
1,5	5	RU 6420-34	RU 6420-43
2	6	RU 6420-35	RU 6420-44
2,3	7	RU 6420-36	RU 6420-45
2,5	8	RU 6420-37	RU 6420-46
3	9	RU 6420-38	RU 6420-47
3,3	10	RU 6420-39	RU 6420-48
3,5	11	RU 6420-40	RU 6420-49
4	12	RU 6420-41	RU 6420-50
5	15	RU 6420-42	RU 6420-51



olivenförmig
olive-shaped



FRAZIER

		Arbeitslänge Working length
Ø mm	Charr./Fr.	100 mm – 4"
2	6	RU 6420-56
2,5	8	RU 6420-58
3,3	10	RU 6420-60
4	12	RU 6420-62
5	15	RU 6420-65

Abstandsmarkierungen bei 5 - 9 cm
Calibrations marked at 5 - 9 cm

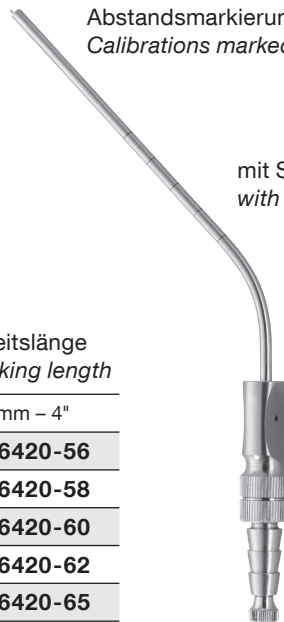

FRAZIER

mit Saugunterbrecher und Mandrel
with with cut-off and stylet

		Arbeitslänge Working length
Ø mm	Charr./Fr.	100 mm – 4"
2	6	RU 6420-76
2,5	8	RU 6420-78
3,3	10	RU 6420-80
4	12	RU 6420-82
5	15	RU 6420-85



FERGUSSON

mit Mandrel
with stylet

		Arbeitslänge Working length
Ø mm	Charr./Fr.	100 mm – 4"
2	6	RU 6421-06
2,3	7	RU 6421-07
2,5	8	RU 6421-08
3	9	RU 6421-09
3,3	10	RU 6421-10
3,5	11	RU 6421-11
4	12	RU 6421-12
5	15	RU 6421-15

mit Saugunterbrecher und Mandrel
with cut-off and stylet



ADSON

		Arbeitslänge Working length
Ø mm	Charr./Fr.	145 mm – 5¾"
4	12	RU 6426-21

mit Langloch Saugunterbrecher und Mandrel
with elongated cut-off and stylet



POP PEN

Ø mm	Charr./Fr.	Arbeitslänge <i>Working length</i>	
		90 mm – 3½"	145 mm – 5¾"
2	6	RU 6426-50	RU 6426-60
2,3	7	RU 6426-51	RU 6426-61
2,5	8	RU 6426-52	RU 6426-62
3	9	RU 6426-53	RU 6426-63
3,3	10	RU 6426-54	RU 6426-64
3,5	11	RU 6426-55	RU 6426-65
4	12	RU 6426-56	RU 6426-66
5	15	RU 6426-57	RU 6426-67

Saugrohr, keramikbeschichtet
suction tube, ceramic coated



Ø mm		Arbeitslänge <i>Working length</i>	
Charr./Fr.			
3	9	RU 6427-100	

Ø mm		Arbeitslänge <i>Working length</i>	
Charr./Fr.			
3	9	RU 6427-130	

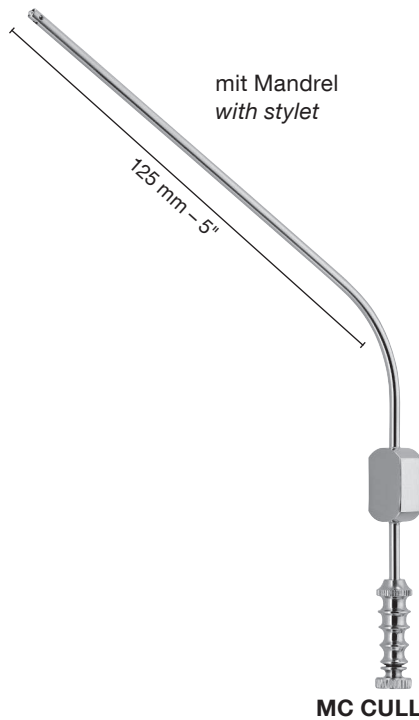

		Arbeitslänge Working length
Ø mm	Charr./Fr.	125 mm - 5"
1,5	5	RU 6427-01
2,3	7	RU 6427-02
3	9	RU 6427-03
4	12	RU 6427-04

MC CULLOCH



		Arbeitslänge Working length
Ø mm	Charr./Fr.	70 mm - 2¾"
1	3	RU 7845-03
1,5	5	RU 7845-05
2,3	7	RU 7845-07

BARON

Olive
Olive
Ø 8 mm



		Arbeitslänge Working length
Ø mm	Gauges	80 mm - 3¼"
0,9	20	RU 7845-20
0,7	22	RU 7845-22
0,5	24	RU 7845-24

SCHUKNECHT

Olive
Olive
Ø 8 mm

Saug-Raspatorien, Saug-Dissektoren Suction Raspatories, Suction Dissectors



Trokare, Saug- und Spülinstrumente,
Sonden, Watteträger
Trocars, Suction and Irrigation Instruments,
Probes, Cotton Applicators

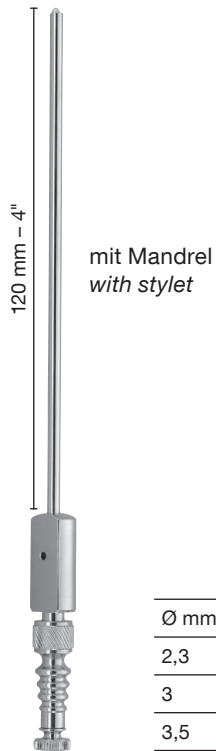

FRAZIER

Ø mm	Charr./Fr.	Arbeitslänge Working length
		120 mm - 4"
2,3	7	RU 6424-20
3	9	RU 6424-21
3,5	11	RU 6424-22

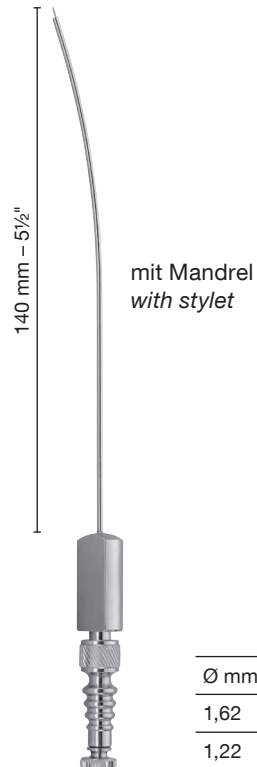

PRIBRAM

Ø mm	Gauges	Arbeitslänge Working length
		140 mm - 5 1/2"
1,62	16	RU 6424-40
1,22	18	RU 6424-41

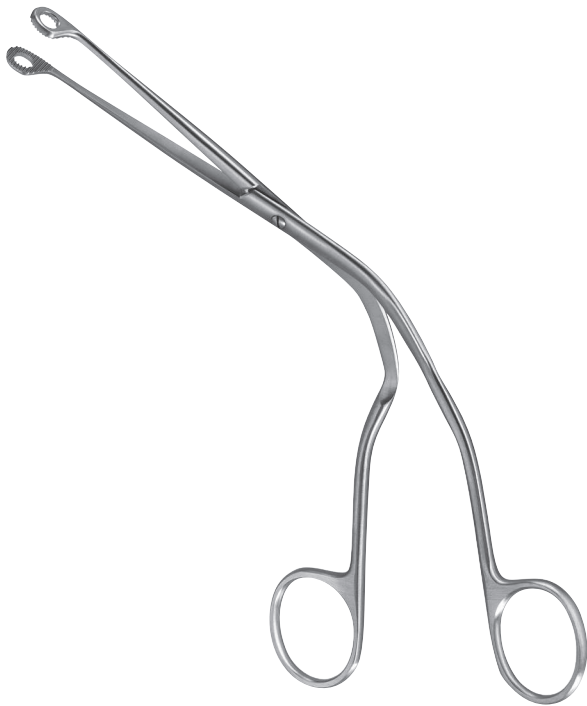

MAGILL



für Kleinkinder
for infants

15 cm – 6"

RU 5295-15



für Kinder
for children

20 cm – 8"

RU 5295-20

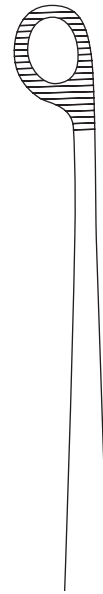

für Erwachsene
for adults

25 cm – 10"

RU 5295-25



Luer-Lock Ansatz
Luer Lock connector

ml cc	Dreiring-Spritze <i>3 ring syringe</i>
2	RU 5285-02
5	RU 5285-05
10	RU 5285-10

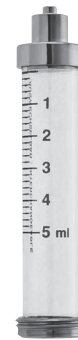

ml cc	Zylinder <i>Cylinder</i>
2	RU 5285-52
5	RU 5285-55
10	RU 5285-60



JANET

ml cc	Spritze mit 2 Kanülen <i>Syringe with 2 cannulas</i>	Spritze, allein <i>Syringe, only</i>	Zylinder, allein <i>Cylinder, only</i>
50	RU 5286-05	RU 5286-55	RU 5286-75
75	RU 5286-07	RU 5286-57	RU 5286-77
100	RU 5286-10	RU 5286-60	RU 5286-80
150	RU 5286-15	RU 5286-65	RU 5286-85
200	RU 5286-20	RU 5286-70	RU 5286-90

Luer-Lock Adapter

Luer-Lock Adapter



1:1

LLA weiblich
RC männlich
LLA female
RC male

RU 5288-01



1:1

RC weiblich
LA männlich
RC female
LA male

RU 5288-02



1:1

LLA weiblich
LLA female

RU 5288-21



1:1

LLA männlich
LLA male

RU 5288-03



1:1

LLA weiblich
LLA female

RU 5288-04



1:1

LLA männlich
LLA male

RU 5288-31

LA = Luer Konus Adapter
LLA = Luer-Lock Adapter
RC = Record Konus Adapter

LA = luer cone adapter
LLA = luer-lock adapter
RC = record conus adapter

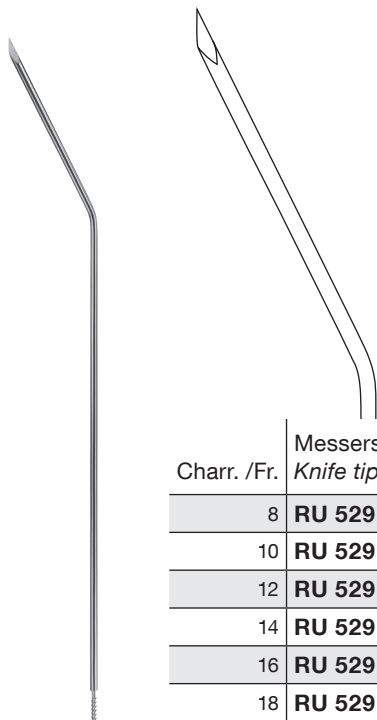

Charr. /Fr.	Messerspitze, leicht gebogen <i>Knife tip, slightly curved</i>
8	RU 5291-08
10	RU 5291-10
12	RU 5291-12
14	RU 5291-14
16	RU 5291-16
18	RU 5291-18

REDON

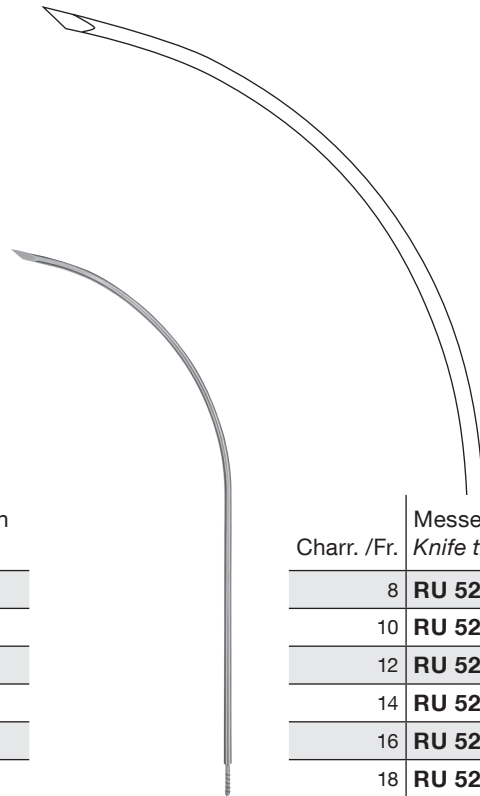

Charr. /Fr.	Messerspitze, gebogen <i>Knife tip, curved</i>
8	RU 5291-28
10	RU 5291-30
12	RU 5291-32
14	RU 5291-34
16	RU 5291-36
18	RU 5291-38

REDON

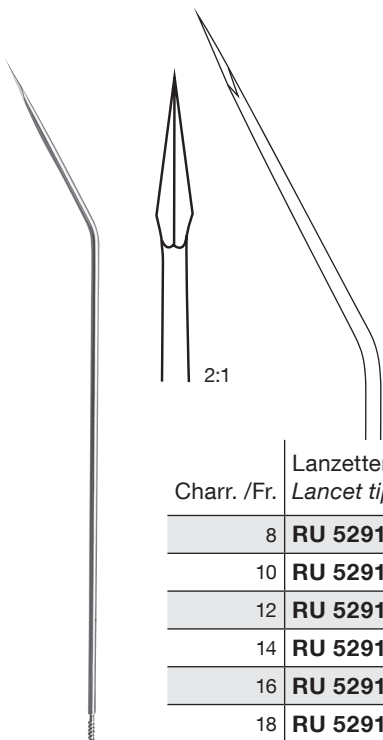

Charr. /Fr.	Lanzettenspitze, leicht gebogen <i>Lancet tip, slightly curved</i>
8	RU 5291-48
10	RU 5291-50
12	RU 5291-52
14	RU 5291-54
16	RU 5291-56
18	RU 5291-58

REDON

Doppelknopfsonde
Double-ended Probe

	Ø 1 mm	Ø 1,5 mm	Ø 2 mm
11,5 cm – 4½"	RU 4900-11	RU 4901-11	RU 4902-11
13 cm – 5"	RU 4900-13	RU 4901-13	RU 4902-13
14,5 cm – 5¾"	RU 4900-14	RU 4901-14	RU 4902-14
16 cm – 6¼"	RU 4900-16	RU 4901-16	RU 4902-16
18 cm – 7"	RU 4900-18	RU 4901-18	RU 4902-18
20 cm – 8"	RU 4900-20	RU 4901-20	RU 4902-20
25 cm – 10"	RU 4900-25	RU 4901-25	RU 4902-25

Öhrsonde
Probe with eye

11,5 cm – 4½"	RU 4906-11
13 cm – 5"	RU 4906-13
14,5 cm – 5¾"	RU 4906-14
16 cm – 6¼"	RU 4906-16
18 cm – 7"	RU 4906-18
20 cm – 8"	RU 4906-20



	Sonde <i>Probe</i>
14 cm – 5½"	RU 4907-13
18 cm – 7"	RU 4907-18

WATSON-CHEYNE



	Sonde <i>Probe</i>
14,5 cm – 5¾"	RU 4908-14
18 cm – 7"	RU 4908-18

FISH

Trokare, Saug- und Spülinstrumente,
Sonden, Watteträger
Trocars, Suction and Irrigation Instruments,
Probes, Cotton Applicators



Hohlsonde <i>Director</i>	
11,5 cm – 4½"	RU 4910-11
13 cm – 5"	RU 4910-13
14,5 cm – 5¾"	RU 4910-14
16 cm – 6¼"	RU 4910-16
18 cm – 7"	RU 4910-18
20 cm – 8"	RU 4910-20



Sonde, gebogen <i>Probe, curved</i>	
14,5 cm – 5¾"	RU 4911-14

DOYEN



Hohlsonde <i>Director</i>	
13 cm – 5"	RU 4912-13
14,5 cm – 5¾"	RU 4912-14
16 cm – 6¼"	RU 4912-16
18 cm – 7"	RU 4912-18



Sonde
Probe

14,5 cm – 5¾"	RU 4913-14
---------------	-------------------



Myrtenblattsonde <i>Myrtle leaf probe</i>	
13 cm – 5"	RU 4914-13
14,5 cm – 5¾"	RU 4914-14
16 cm – 6¼"	RU 4914-16
20 cm – 8"	RU 4914-20

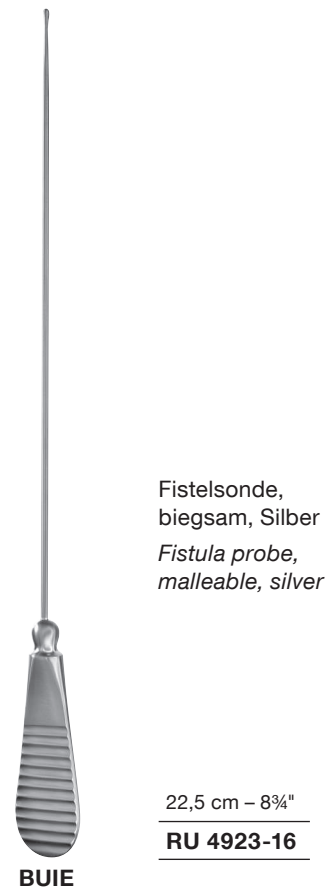
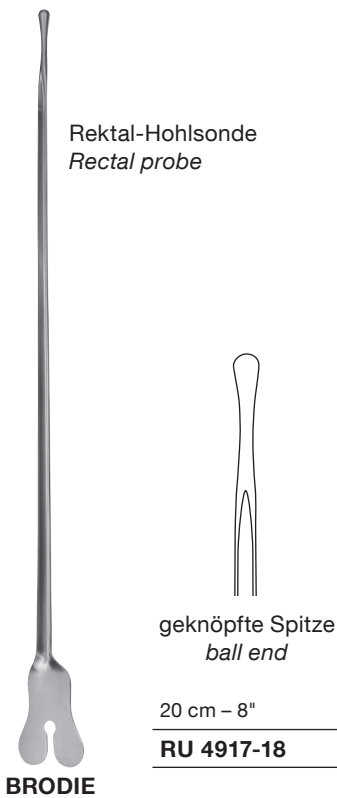
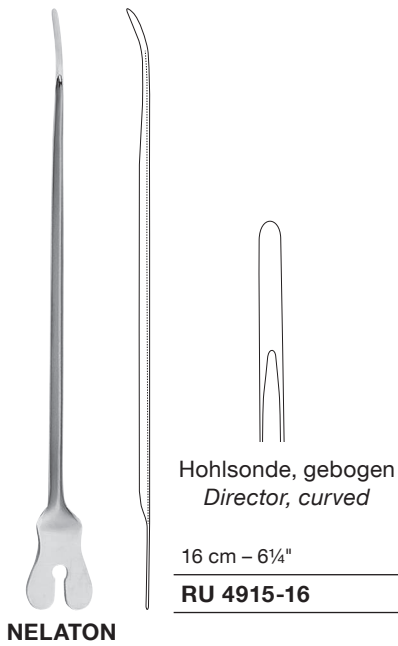



LOCKART-MUMMARY

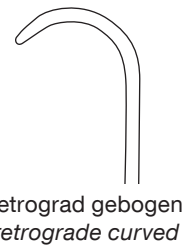
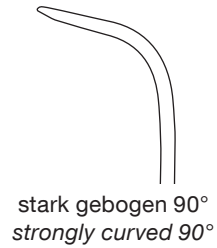
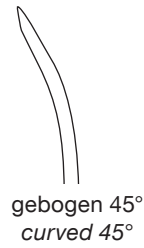
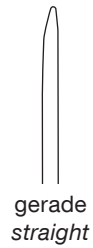

17 cm – 6¾"

Fig. 1	Fig. 2	Fig. 3	Fig. 4
RU 4925-01	RU 4925-02	RU 4925-03	RU 4925-04

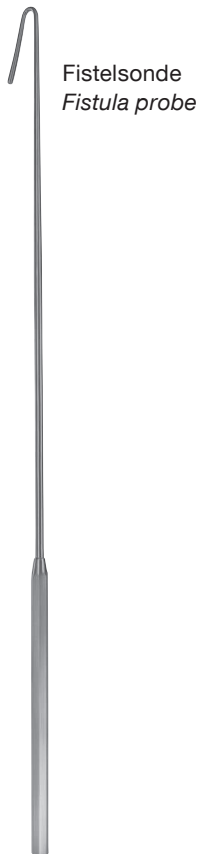

PRATT

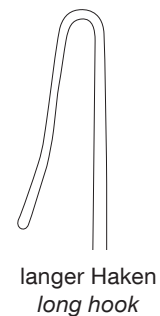
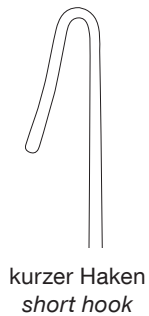
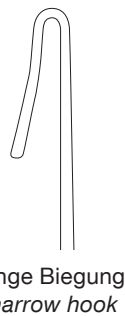

21 cm – 8¼"

RU 4926-01	RU 4926-02	RU 4926-03
-------------------	-------------------	-------------------

Watteträger
Cotton Applicators

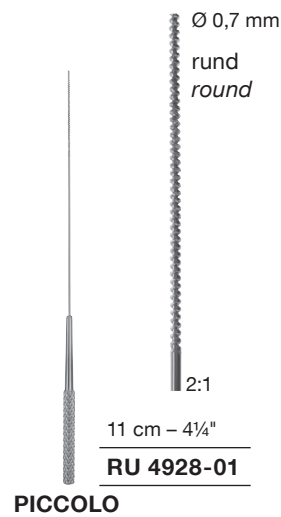
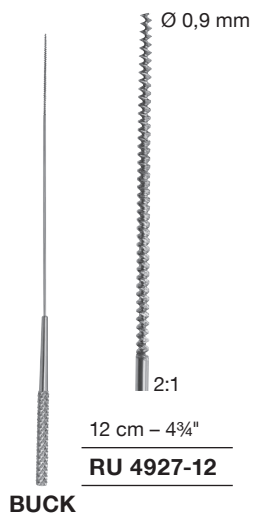

Watteträger Cotton Applicators

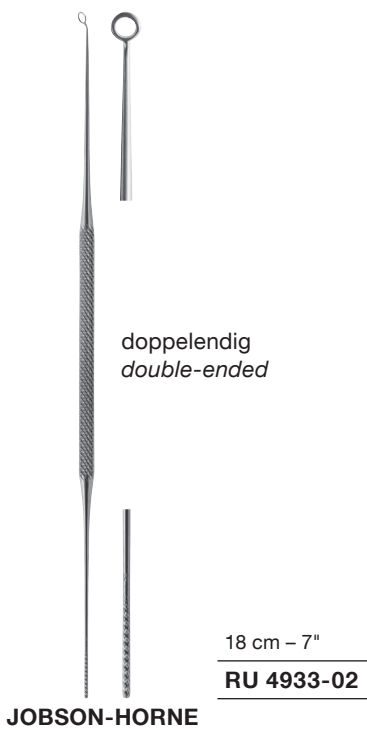
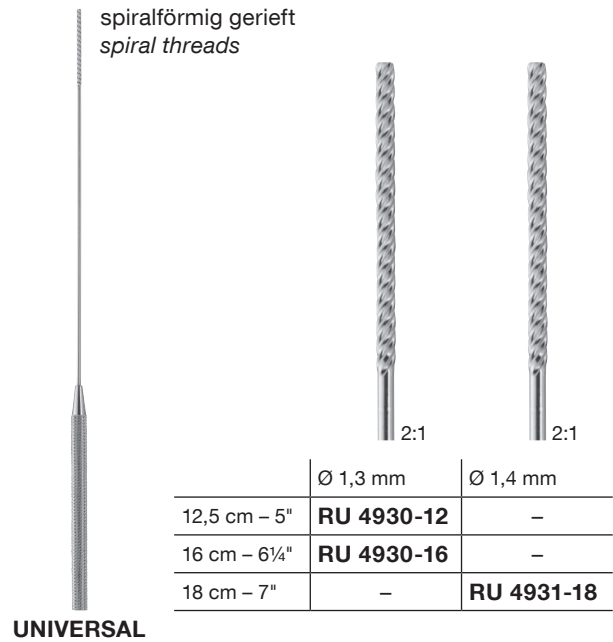
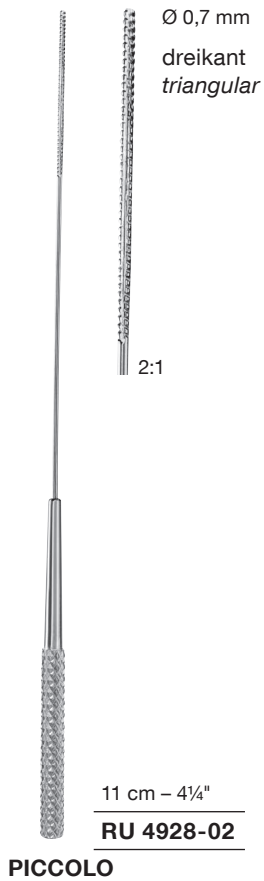

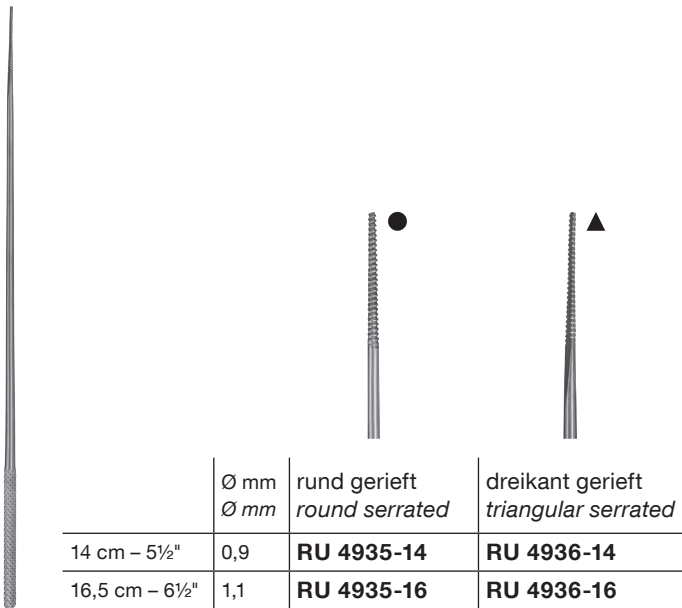

	Ø mm Ø mm	rund gerieft round serrated	dreikant gerieft triangular serrated
14 cm – 5½"	0,9	RU 4935-14	RU 4936-14
16,5 cm – 6½"	1,1	RU 4935-16	RU 4936-16

FARRELL

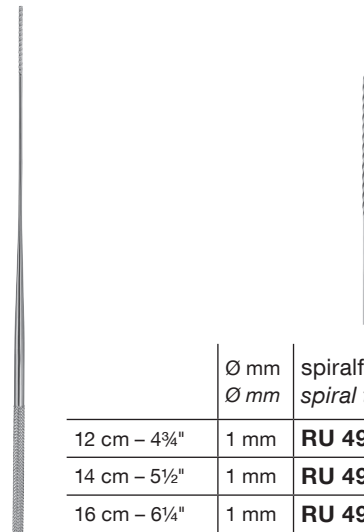

	Ø mm Ø mm	spiralförmig spiral threads
12 cm – 4¾"	1 mm	RU 4934-01
14 cm – 5½"	1 mm	RU 4934-02
16 cm – 6¼"	1 mm	RU 4934-03

FROHN

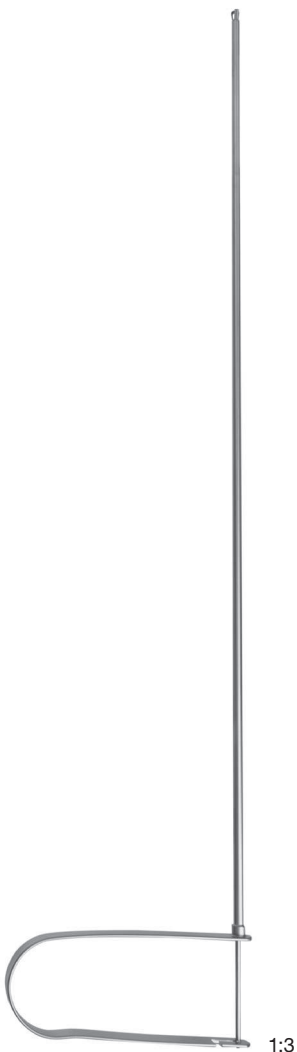

1:3



Schaftlänge Shaft length	dreiteiliges Maul with 3 expanding jaws
28 cm – 11"	RU 4941-28
38 cm – 15"	RU 4941-45



Nadelhalter-Profil	<i>Needle Holder Tread</i>	WO 1 - 2
Mikro-Nadelhalter	<i>Micro Needle Holders</i>	WO 3 - 9
Nadelhalter	<i>Needle Holders</i>	WO 10 - 37
Unterbindungsnadeln	<i>Ligature Needles</i>	WO 38 - 43
Reverdinnadeln	<i>Reverdin Needles</i>	WO 44 - 45
Führungs-Hohlsonden	<i>Guiding Probes</i>	WO 46 - 50
Wundklammern	<i>Suture Clips</i>	WO 51
Klammeranlegepinzetten	<i>Clip Applying Forceps</i>	WO 52
Chirurgisches Taschenbesteck	<i>Pocket Instrument Set</i>	WO 53
Venae Sectio Besteck	<i>Venae Secito Set</i>	WO 54
Gipsverband-Instrumente	<i>Plaster Cast Instruments</i>	WO 55 - 58

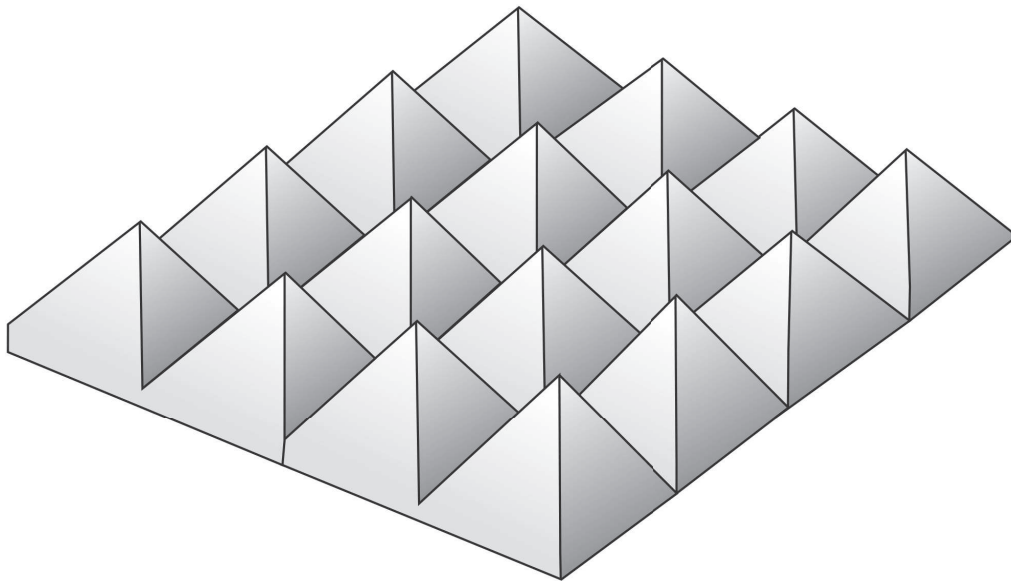

TC

RUDOLF Medical TC Nadelhalter mit diamant-geschliffenem Profil

Für die RUDOLF Medical Nadelhalter werden nur Nadelhalterplatten mit diamant-geschliffenem Pyramidenprofil verwendet.

RUDOLF Medical TC Nadelhalter entsprechen höchsten Ansprüchen:

- präzise Ausführung und hervorragende Qualität
- optimale Abstimmung des Nadelhalters und der TC-Einlage auf den Verwendungszweck
- grazile Nadelhalter für feinste Arbeiten,
- stabile Nadelhalter für größere Nadeln.
- sichere und präzise Sperre, abgestimmt auf die Gesamtstärke des Nadelhalters.

Nur ein diamant-geschliffenes Nadelhalterprofil garantiert:

- die hohe Präzision der eingeschliffenen Pyramidenstruktur
- das homogene, tiefgeschliffene Profil der TC-Platten
- den sicheren Halt der Nadel oder des Nahtmaterials.
- hohe Profil-Formbeständigkeit, Härte und Verschleißfestigkeit.

RUDOLF Medical TC Needle Holders with diamond-cut tread

For the TC needle holders RUDOLF Medical uses only diamond-cut TC inserts with pyramidal tread.

RUDOLF Medical TC Needle Holders meet the highest requirements:

- *precise design and excellent quality*
- *optimal matching of the needle holder and the TC inserts to the application purpose*
- *slim needle holders for delicate applications,*
- *solid needle holders for larger needles*
- *firm and precise ratchet corresponding to the design of the needle holder.*

Only a diamond-cut needle holder tread guarantees:

- *a high precision of the pyramidal structure of the tread*
- *homogeneous and deep tread of the TC inserts*
- *firm holding of the needle or of the suturing material*
- *high deformation resistance, hardness and wear resistance even of the most delicate tread.*

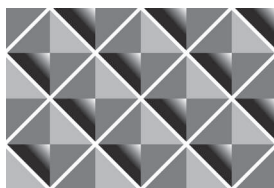

0,5 mm
für Nadeln und Nahtmaterial
bis Stärke 3/0
2500 tpsi (teeth per square inch)
for needles and suturing material
with a thickness of up to 3/0

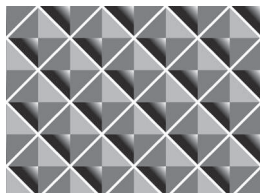

0,4 mm
für feine Nadeln und Nahtmaterial,
Stärke 4/0 – 6/0
3600 tpsi (teeth per square inch)
for delicate needles and suturing
material with a thickness of up to 4/0 - 6/0

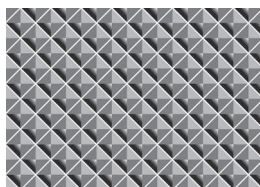

0,3 mm
für feine Nadeln und Nahtmaterial
bis Stärke 8/0
7000 tpsi (teeth per square inch)
for delicate needles and suturing
material with a thickness of up to 8/0

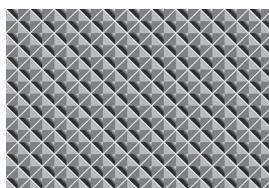

0,2 mm
für feinste Nadeln und Nahtmaterial,
Stärke 6/0 – 10/0
14400 tpsi (teeth per square inch)
for delicate needles and suturing
material, thickness 6/0 – 10/0

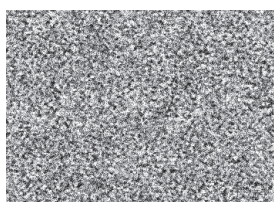

MICROGRIP
für extrem feines Nahtmaterial,
Stärke 6/0 – 11/0
for extremely delicate suturing material,
thickness 6/0 – 11/0



Glatt,
für extrem feines Nahtmaterial,
Stärke 6/0 – 11/0
Smooth,
for extremely delicate suturing material,
thickness 6/0 – 11/0

Mikro-Nadelhalter Micro Needle Holders



gerade
straight



gebogen
curved

	mit Sperre <i>with ratchet</i>	ohne Sperre <i>without ratchet</i>	mit Sperre <i>with ratchet</i>	ohne Sperre <i>without ratchet</i>
15 cm – 6"	RU 5852-15	RU 5850-15	RU 5853-15	RU 5851-15



gerade
straight



gebogen
curved

	mit Sperre <i>with ratchet</i>	ohne Sperre <i>without ratchet</i>	mit Sperre <i>with ratchet</i>	ohne Sperre <i>without ratchet</i>
18 cm – 7"	RU 5852-18	RU 5850-18	RU 5853-18	RU 5851-18



JACOBSON

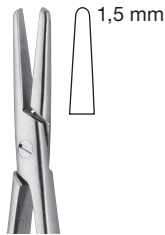

gerade
straight

	mit Sperre with ratchet	ohne Sperre without ratchet
18 cm – 7"	RU 5854-36	RU 5854-39
21 cm – 8¼"	RU 5854-46	RU 5854-49



JACOBSON



gerade
straight

	Typ Type	mit Sperre with ratchet
18 cm – 7"	TC	RU 5930-32
20 cm – 8"	TC	RU 5930-42
22,5 cm – 8¾"	TC	RU 5930-52

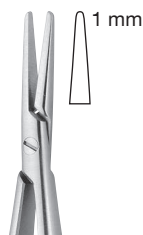

gerade
straight



gebogen
curved

	mit Sperre with ratchet	ohne Sperre without ratchet	mit Sperre with ratchet	ohne Sperre without ratchet
12 cm – 4¾"	RU 5864-12	RU 5860-12	RU 5865-12	RU 5861-12
14,5 cm – 5¾"	RU 5864-15	RU 5860-15	RU 5865-15	RU 5861-15
18 cm – 7"	RU 5864-18	RU 5860-18	RU 5865-18	RU 5861-18
21 cm – 8¼"	RU 5864-21	RU 5860-21	RU 5865-21	RU 5861-21
23 cm – 9"	RU 5864-23	RU 5860-23	RU 5865-23	RU 5861-23

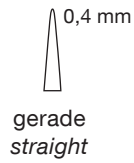
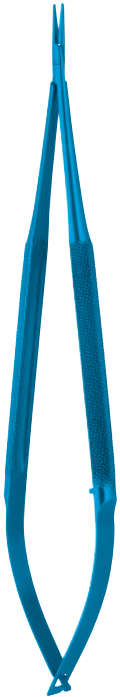

	Typ Type	ohne Sperre without ratchet		ohne Sperre without ratchet	
14,5 cm – 5¾"	TI	RU 5862-14T	RU 5862-15T	RU 5862-18T	RU 5862-19T
18 cm – 7"	TI	RU 5862-34T	RU 5862-35T	RU 5862-38T	RU 5862-39T
21 cm – 8¼"	TI	RU 5862-44T	RU 5862-45T	RU 5862-48T	RU 5862-49T

Mikro-Nadelhalter Micro Needle Holders



CASTROVIEJO

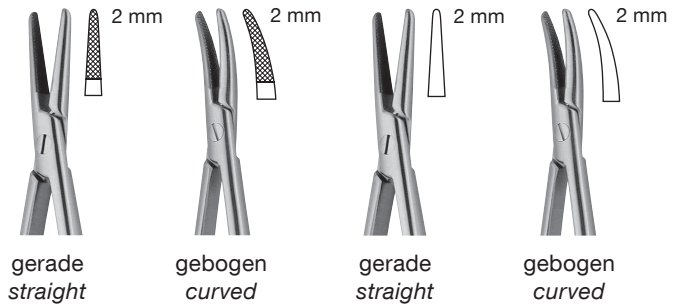

	Typ Type	mit Sperre with ratchet		mit Sperre with ratchet	
		Körnung Grit	Körnung Grit	glatt smooth	glatt smooth
14 cm – 5½"	TC	RU 5931-12	RU 5931-13	RU 5931-16	RU 5931-17
18 cm – 7"	TC	RU 5931-32	RU 5931-33	RU 5931-36	RU 5931-37
21 cm – 8¼"	TC	RU 5931-42	RU 5931-43	RU 5931-46	RU 5931-47



CASTROVIEJO/BARRAQUER

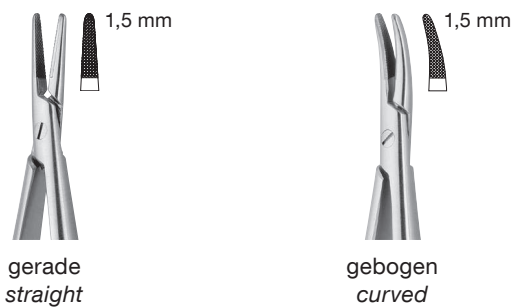

	Typ Type	mit Sperre with ratchet	ohne Sperre without ratchet	mit Sperre with ratchet	ohne Sperre without ratchet
		14,5 cm – 5¾"	TC	RU 5866-12	RU 5866-14
18 cm – 7"	TC	RU 5866-32	RU 5866-34	RU 5866-33	RU 5866-35
21 cm – 8¼"	TC	RU 5866-42	RU 5866-44	RU 5866-43	RU 5866-45
23 cm – 9"	TC	RU 5866-52	RU 5866-54	RU 5866-53	RU 5866-55

Mikro-Nadelhalter Micro Needle Holders



CASTROVIEJO

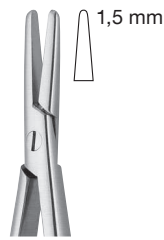

gerade
straight



gebogen
curved

	mit Sperre with ratchet	ohne Sperre without ratchet	mit Sperre with ratchet	ohne Sperre without ratchet
14 cm – 5½"	RU 5952-14	RU 5950-14	RU 5953-14	RU 5951-14



CASTROVIEJO

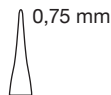

gerade
straight

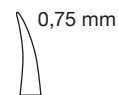

gebogen
curved

	mit Sperre with ratchet	ohne Sperre without ratchet	mit Sperre with ratchet	ohne Sperre without ratchet
9 cm – 3½"	RU 5958-09	RU 5956-09	RU 5959-09	RU 5957-09



CASTROVIEJO

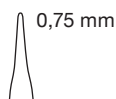

gerade
straight

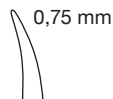

gebogen
curved

	mit Sperre with ratchet	ohne Sperre without ratchet	mit Sperre with ratchet	ohne Sperre without ratchet
14 cm – 5½"	RU 5958-14	RU 5956-14	RU 5959-14	RU 5957-14



BARRAQUER-TROUTMAN



	mit Sperre with ratchet	ohne Sperre without ratchet	mit Sperre with ratchet	ohne Sperre without ratchet
10 cm – 4"	RU 5976-10	RU 5974-10	RU 5977-10	RU 5975-10



BARRAQUER

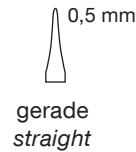

	Typ Type	mit Sperre with ratchet	ohne Sperre without ratchet	
11,5 cm – 4½"		RU 5973-17	RU 5970-11	RU 5971-11
	TI	RU 5973-17T	–	RU 5971-11T



BARRAQUER

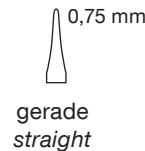

	Typ Type	mit Sperre with ratchet	ohne Sperre without ratchet	
12 cm – 4¾"		RU 5973-12	RU 5970-12	RU 5971-12
	TI	RU 5973-12T	–	RU 5971-12T

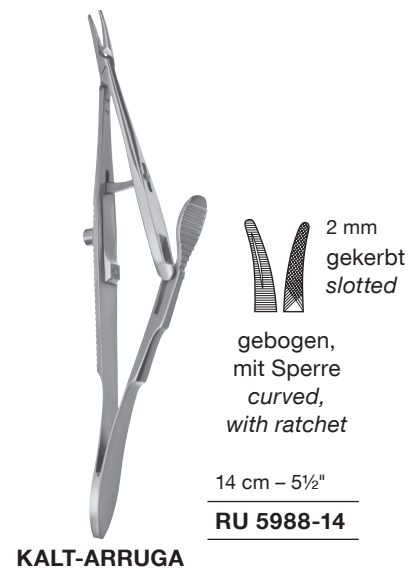
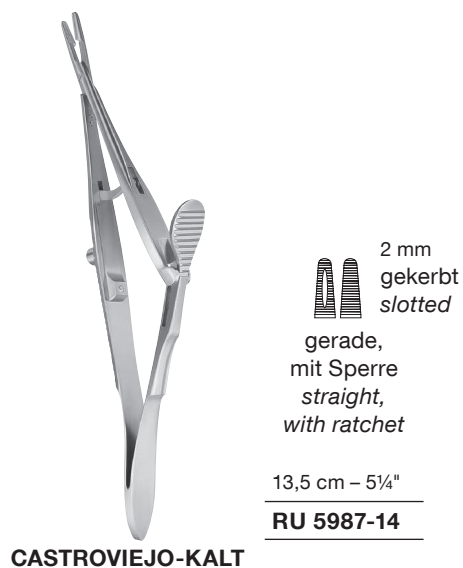
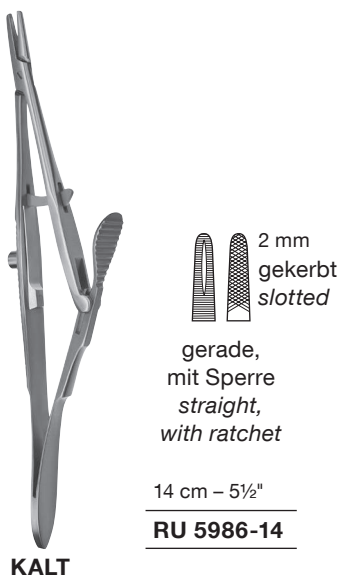
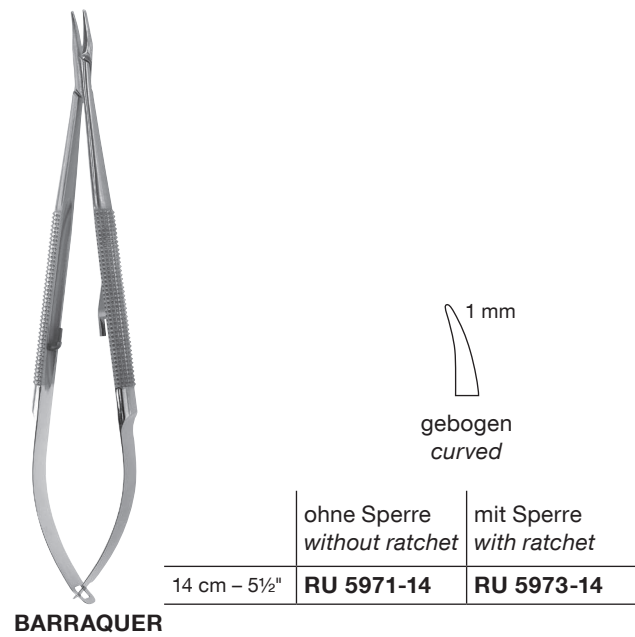
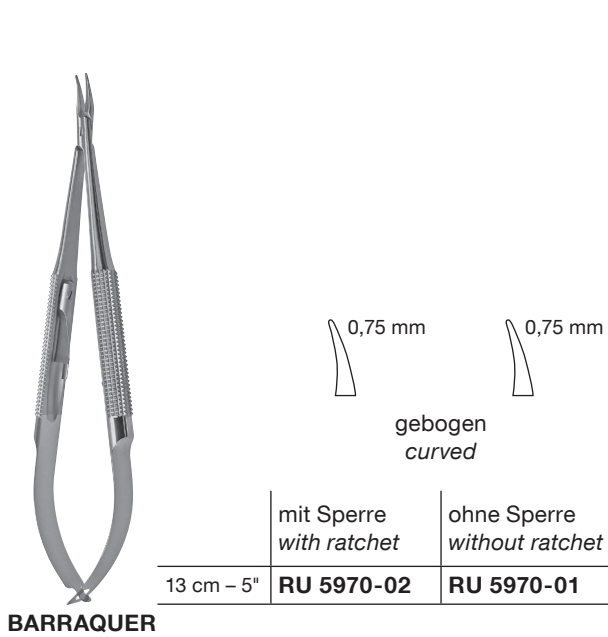



HALSEY

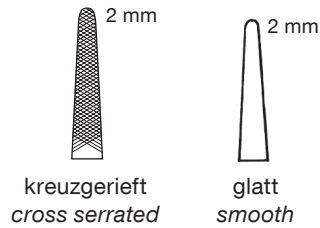

kreuzgerieft
cross serrated

glatt
smooth

13 cm – 5"

RU 5918-13 | **RU 5918-18**



WEBSTER

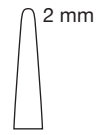

glatt
smooth

13 cm – 5"

RU 5920-13



DERF



gekerbt
slotted

12 cm – 4¾"

RU 5922-12



DERF

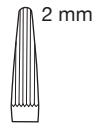

längsgerieft
lengthways serrated

12,5 cm – 5"

RU 5924-12



HEGAR-BAUMGARTNER

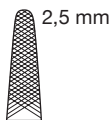

kreuzgerieft
cross serrated

14 cm – 5½"

RU 5927-14



BROWN

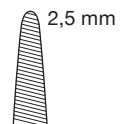

Maul fein gerieft,
Maulteile convex
fine serrated jaws,
convex jaws

13 cm – 5"

RU 5928-13

18 cm – 7"

RU 5928-18



NEW ORLEANS

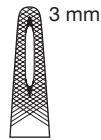

gekerbt
slotted

18 cm – 7"

RU 5929-18



MAYO-HEGAR

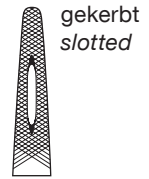

gekerbt
slotted

gerade
straight

14 cm – 5½"	RU 6000-14
16 cm – 6¼"	RU 6000-16
18 cm – 7"	RU 6000-18
20 cm – 8"	RU 6000-20
24 cm – 9½"	RU 6000-24
26 cm – 10¼"	RU 6000-26
30 cm – 11¾"	RU 6000-30



3 mm
gekerbt
slotted

gebogen
curved

16 cm – 6¼" **RU 6001-16**



HEANEY

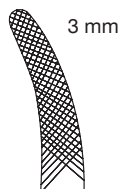

3 mm
gebogen
curved

21 cm – 8¼"

RU 6002-21

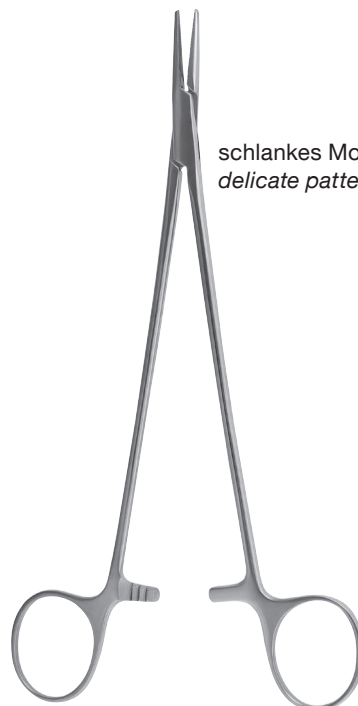

MAYO-HEGAR

schlankes Modell
delicate pattern

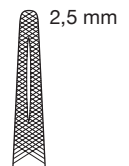

2,5 mm
gekerbt
slotted

16 cm – 6¼"	RU 6003-16
18 cm – 7"	RU 6003-18
20 cm – 8"	RU 6003-20



kräftiges Modell
heavy pattern

HEGAR



gekerbt
slotted



kreuzgerieft
cross serrated

16 cm – 6¼"	RU 6004-16	–
18 cm – 7"	RU 6004-18	–
20 cm – 8"	RU 6004-20	RU 6004-21



gekerbt
slotted

17 cm – 6¾"

RU 6005-17



gekerbt
slotted

18,5 cm – 7¼"

RU 6006-18

26 cm – 10¼"

RU 6006-26

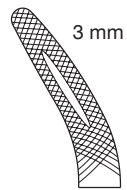

3 mm

gekerbt
slotted

27 cm – 10½"

RU 6007-27

FINOCCHIETTO

1:3

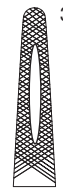
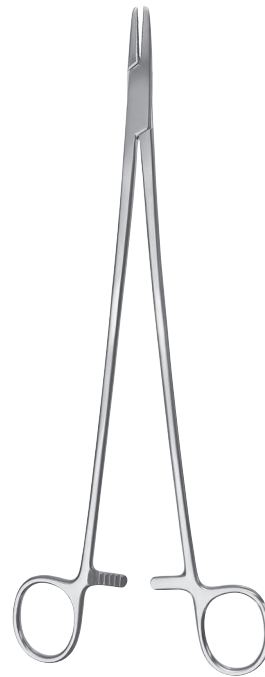

3,5 mm

gekerbt
slotted

26,5 cm – 10½"

RU 6008-27

MASSON

1:3

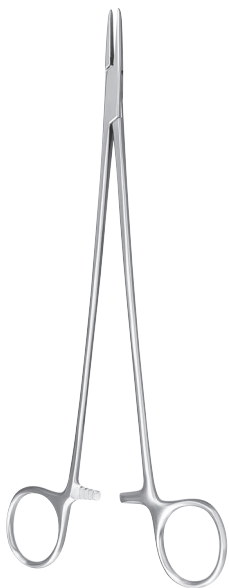

2,5 mm

23,5 cm – 9¼"

RU 6009-23

JAMESON

1:3



3,5 mm

27 cm – 10½"

RU 6010-27

WAGENSTEEN

1:3



CRILE-WOOD

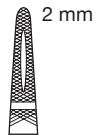

gekerbt
slotted

15 cm – 6"

RU 6012-15



CRILE-MURRAY

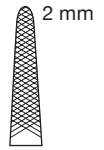

15 cm – 6"

RU 6014-15



ADSON

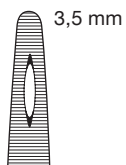

gefenstert
fenestrated

18 cm – 7"

RU 6016-18



SENNING



gekerbt
slotted

17 cm – 6 $\frac{3}{4}$ "

RU 6017-17



BABY-OLSEN-HEGAR

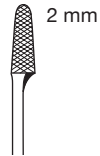

kreuzgerieft
cross serrated

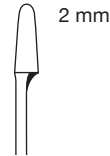

glatt
smooth

11 cm – 4¼"

RU 6029-11	RU 6029-31
-------------------	-------------------



BABY-OLSEN-HEGAR



Körnung 0,4 mm
Grit 3600 tpsi



glatt
smooth

Typ / Type	11,5 cm – 4½"	
TC	RU 6079-11	RU 6079-31



OLSEN-HEGAR



gekerbt
slotted

14 cm – 5½"	RU 6030-14
18 cm – 7"	RU 6030-18



OLSEN-HEGAR

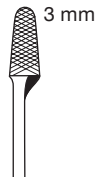

kreuzgerieft
cross serrated

17 cm – 6¾"

RU 6030-17



OLSEN-HEGAR

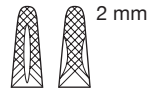

gerade, gekerbt
straight, slotted

14 cm – 5½"

RU 6031-14



OLSEN-HEGAR

Körnung 0,5 mm
Grit 2500 tpsi

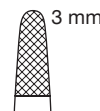
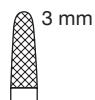

Typ / Type	14 cm – 5½"	17 cm – 6¾"	18,5 cm – 7¼"
TC	RU 6080-14	RU 6080-17	RU 6080-18



GILLIES

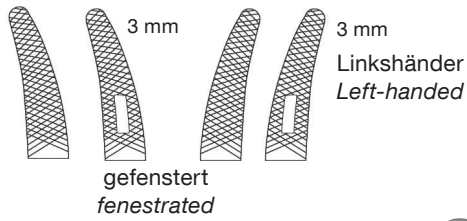

16 cm – 6¼"

RU 6032-16

RU 6032-16L



GILLIES



GILLIES SLIM



gefenstert
fenestrated

15 cm – 6"

RU 6033-14

RU 6033-14L

Nadelhalter Needle Holders

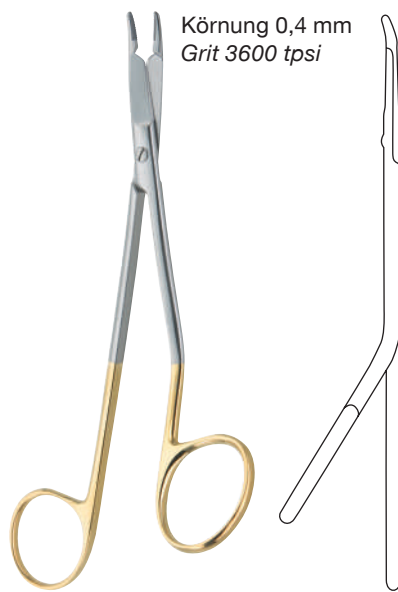

Körnung 0,4 mm
Grit 3600 tpsi



2 mm



2 mm

Linkshänder
Left-handed

Typ / Type	15,5 cm – 6"	
TC	RU 6081-14	RU 6081-14L

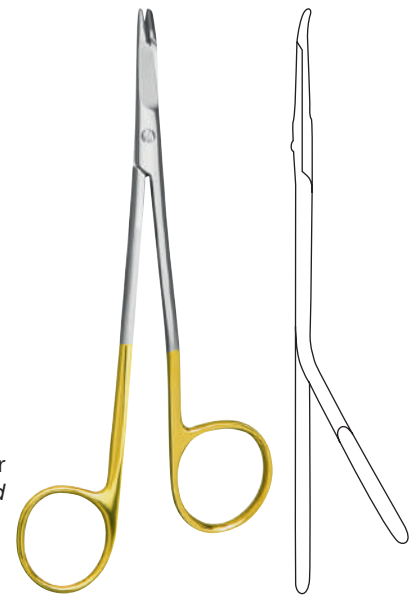

GILLIES SLIM



Körnung 0,5 mm
Grit 2500 tpsi

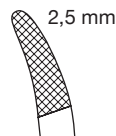

2,5 mm



2,5 mm

Linkshänder
Left-handed

Typ / Type	16 cm – 6¼"	
TC	RU 6081-16	RU 6081-16L

GILLIES

Nadelhalter Needle Holders



PAR

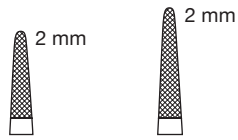

Typ / Type	11,5 cm – 4½"	13,5 cm – 5¼"
TC	RU 6044-01	RU 6044-03



NEIVERT



Typ / Type	13 cm – 5"	
TC	RU 6044-13	RU 6044-13L

Nadelhalter Needle Holders



Körnung 0,4 mm
Grit 3600 tpsi

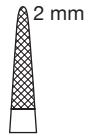

Typ / Type	13 cm – 5"
TC	RU 6045-13

NEIVERT



glatt
smooth

2 mm
Linkshänder
Left-handed

Typ / Type	13 cm – 5"	
TC	RU 6046-13	RU 6046-13L

WEBSTER



WEBSTER



Körnung 0,4 mm
Grit 3600 tpsi



Typ / Type	12,5 cm – 5"
TC	RU 6047-12

DERF

Nadelhalter Needle Holders

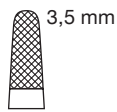

Typ / Type	18 cm – 7"
TC	RU 6048-18

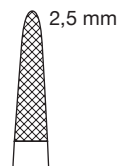
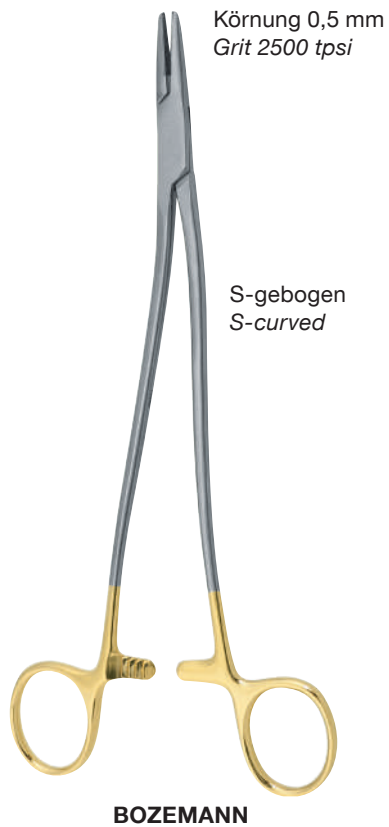

Typ / Type		
TC	20 cm – 8"	RU 6049-20
TC	24 cm – 9½"	RU 6049-24
TC	26 cm – 10¼"	RU 6049-26

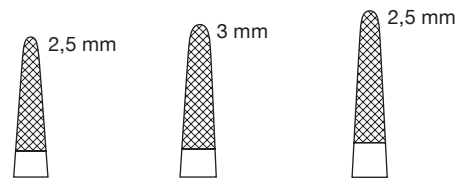

Typ / Type	16 cm – 6¼"	18 cm – 7"	20 cm – 8"
TC	RU 6050-16	RU 6050-18	RU 6050-20



MAYO-HEGAR

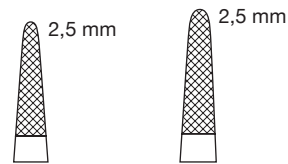

Linkshänder
Left-handed

Linkshänder
Left-handed

Typ / Type	16 cm – 6¼"	18 cm – 7"
TC	RU 6050-16L	RU 6050-18L

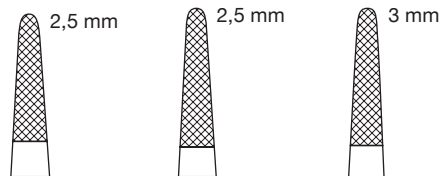

Typ / Type	24 cm – 9½"	26 cm – 10¼"	30 cm – 11¼"
TC	RU 6050-24	RU 6050-26	RU 6050-30

Nadelhalter Needle Holders

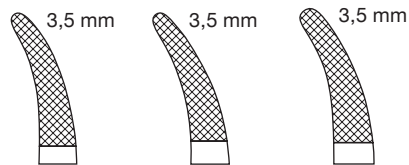
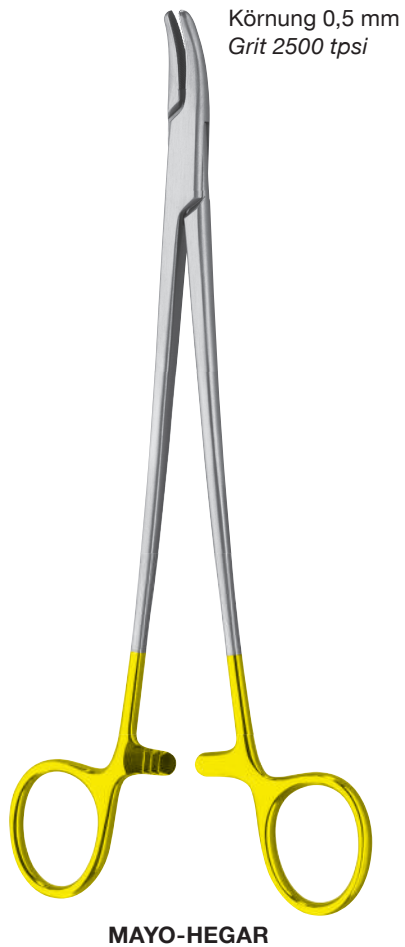

Typ / Type	20 cm – 8"	24 cm – 9½"	26 cm – 10¼"
TC	RU 6051-20	RU 6051-24	RU 6051-26





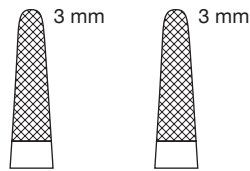
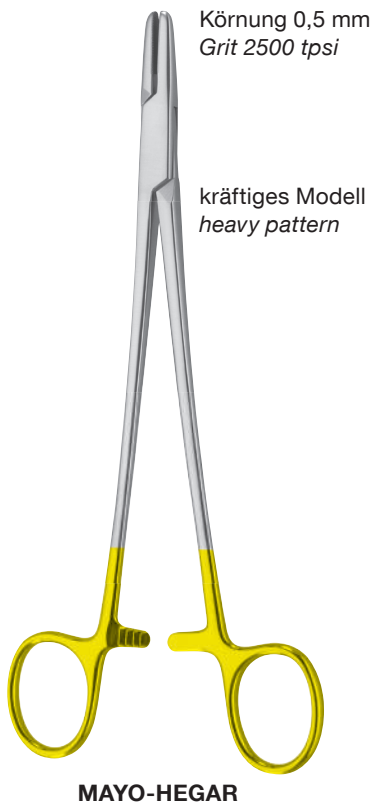

Typ / Type	14 cm – 5½"	
TC	RU 6052-14	RU 6052-14L



Nadelhalter Needle Holders





Typ / Type	20 cm – 8"	24 cm – 9½"
TC	RU 6053-20	RU 6053-24







				
Typ / Type	16 cm – 6¼"	18 cm – 7"	20 cm – 8"	21 cm – 8¼"
TC	RU 6054-40	RU 6054-18	RU 6054-20	RU 6054-41

			
Typ / Type	23 cm – 9"	26,5 cm – 10½"	30,5 cm – 12"
TC	RU 6054-23	RU 6054-26	RU 6054-31



		
	2 mm	2 mm
		Linkshänder Left-handed
Typ / Type	18 cm – 7"	
TC	RU 6054-68	RU 6054-68L

				
	2 mm	2 mm	2 mm	2 mm
Typ / Type	20 cm – 8"	23 cm – 9"	26,5 cm – 10½"	30,5 cm – 12"
TC	RU 6054-70	RU 6054-73	RU 6054-76	RU 6054-81

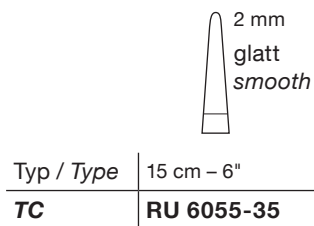
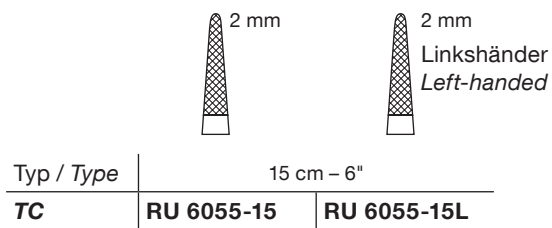
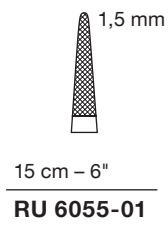

Nadelhalter Needle Holders

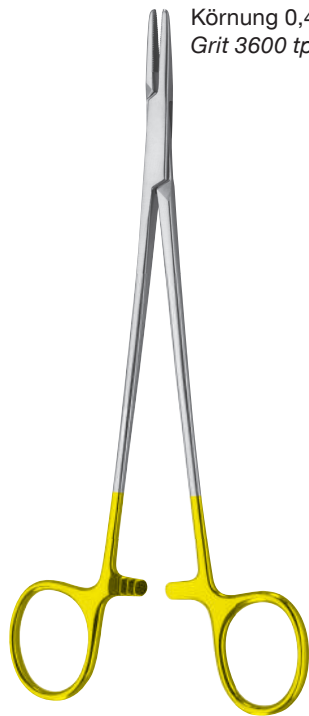

Körnung 0,4 mm
Grit 3600 tpsi

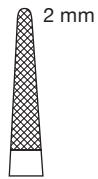

2 mm
Linkshänder
Left-handed

Typ / Type	18 cm – 7"	
TC	RU 6055-18	RU 6055-18L

CRILE-WOOD

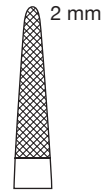
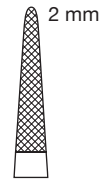
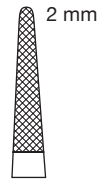
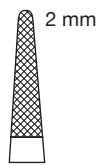

Typ / Type	20 cm – 8"	23 cm – 9"	26 cm – 10¼"	31 cm – 12¼"
TC	RU 6055-20	RU 6055-23	RU 6055-26	RU 6055-31



Körnung 0,3 mm
Grit 7000 tpsi

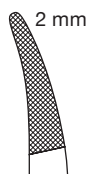

Typ / Type	20 cm – 8"
TC	RU 6055-50

JULIAN

Nadelhalter Needle Holders



Körnung 0,4 mm
Grit 3600 tpsi

CRILE-WOOD

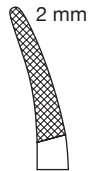

Typ / Type	23 cm - 9"
TC	RU 6055-53



Körnung 0,4 mm
Grit 3600 tpsi

HALSEY

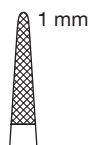

Typ / Type	13 cm - 5"
TC	RU 6056-13
TI	RU 6056-13T



Typ / Type	13 cm - 5"
TC	RU 6056-33

Nadelhalter Needle Holders



CONVERSE

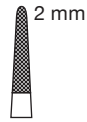

Typ / Type	12,5 cm – 5"
TC	RU 6057-12



KILNER

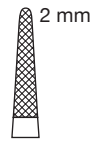

Typ / Type	13,5 cm – 5¼"
TC	RU 6058-13



HEGAR-VASCULAR

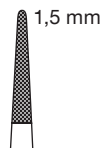

	Typ Type	gerade straight
14 cm – 5½"	TC	RU 6059-39
18 cm – 7"	TC	RU 6059-40
20 cm – 8"	TC	RU 6059-41
23 cm – 9"	TC	RU 6059-42

Nadelhalter Needle Holders



Typ / Type	14 cm – 5½"	18 cm – 7"	20 cm – 8"	22 cm – 8¾"
TC	RU 6059-29	RU 6059-30	RU 6059-31	RU 6059-32

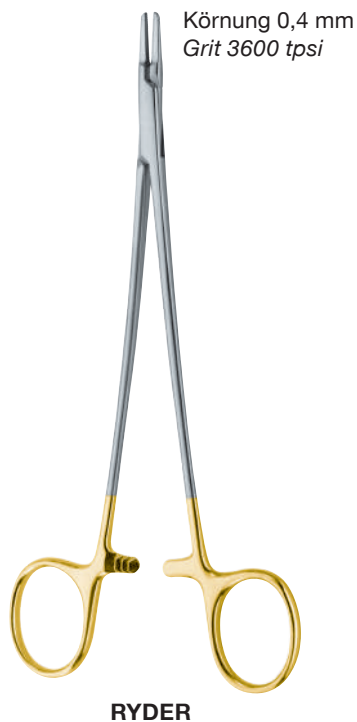

Typ / Type	13 cm – 5"	15 cm – 6"	
TC	RU 6059-13	RU 6059-16	RU 6059-16L

Typ / Type	18 cm – 7"	
TC	RU 6059-18	RU 6059-18L

Typ / Type	20 cm – 8"	23 cm – 9"	25 cm – 10"
TC	RU 6059-20	RU 6059-23	RU 6059-26

Nadelhalter Needle Holders



Körnung 0,2 mm
Grit 14400 tpsi

MICRO-RYDER

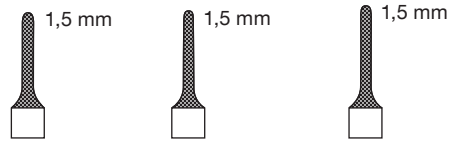

Typ / Type	13 cm – 5"	15 cm – 6"	18 cm – 7"
TC	RU 6059-63	RU 6059-65	RU 6059-68

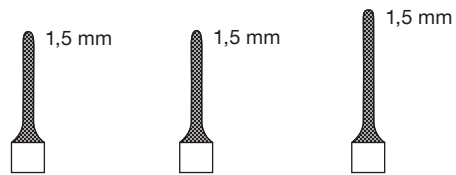

Typ / Type	20 cm – 8"	23 cm – 9"	26 cm – 10¼"
TC	RU 6059-70	RU 6059-73	RU 6059-76



Körnung 0,3 mm
Grit 7000 tpsi

RUDOLF (SWEDISH PATTERN)

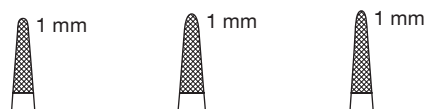

Typ / Type	15 cm – 6"	17 cm – 6¾"	20 cm – 8"
TC	RU 6060-01	RU 6060-02	RU 6060-03

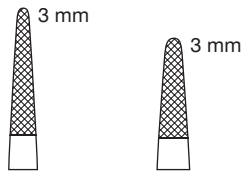

Typ / Type	18 cm - 7"	26 cm - 10¼"
TC	RU 6060-18	RU 6060-26

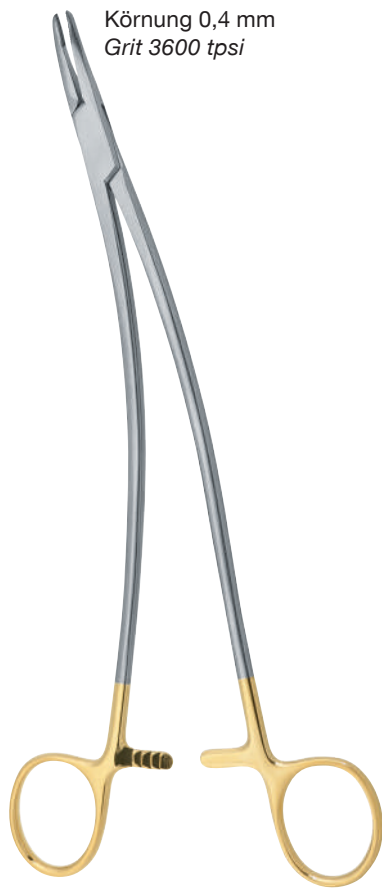

STRATTE



Typ / Type	23 cm – 9"
TC	RU 6061-23



MASSON

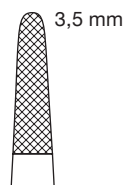

Typ / Type	27 cm – 10½"
TC	RU 6062-27

Nadelhalter Needle Holders

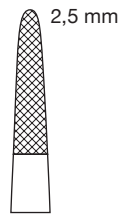

Typ / Type	27 cm – 10½"
TC	RU 6063-27

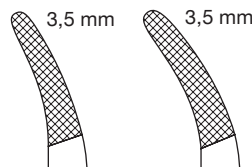

Typ / Type	20 cm – 8"	27 cm – 10½"
TC	RU 6064-20	RU 6064-27



MATHIEU

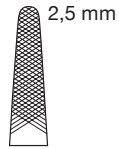

2,5 mm

kreuzgerieft
cross serrated

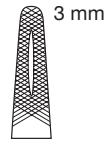

3 mm

gekerbt
slotted

14 cm – 5½"	RU 6040-14	RU 6042-14
17 cm – 6¾"	RU 6040-17	RU 6042-17
20 cm – 8"	RU 6040-20	RU 6042-20



MATHIEU

Körnung 0,4 mm
Grit 3600 tpsi

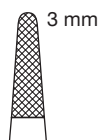

3 mm

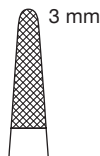

3 mm

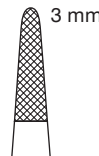

3 mm

Typ / Type	14 cm – 5½"	17 cm – 6¾"	20 cm – 8"
TC	RU 6065-14	RU 6065-17	RU 6065-20

Nadelhalter Needle Holders

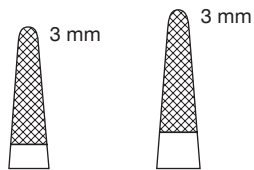

Typ / Type	17 cm – 6¾"	20 cm – 8"
TC	RU 6066-17	RU 6066-20

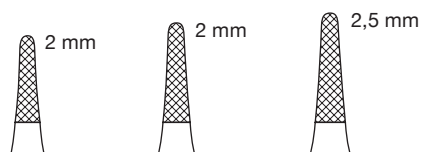

Typ / Type	14 cm – 5½"	17 cm – 6¾"	20 cm – 8"
TC	RU 6070-14	RU 6070-17	RU 6070-20

Nadelhalter Needle Holders

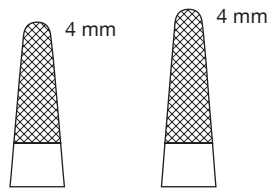
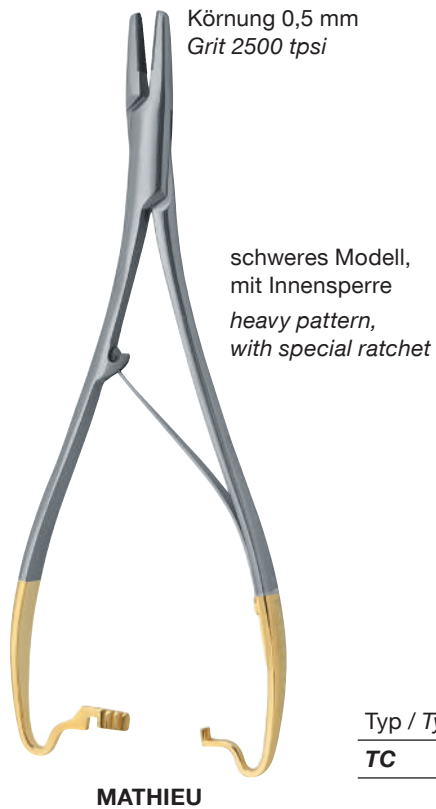

Typ / Type	20 cm – 8"	24 cm – 9½"
TC	RU 6072-20	RU 6072-24

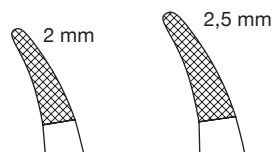

Typ / Type	17 cm – 6¾"	20 cm – 8"
TC	RU 6073-17	RU 6073-20

Unterbindungsnadeln Ligature Needles

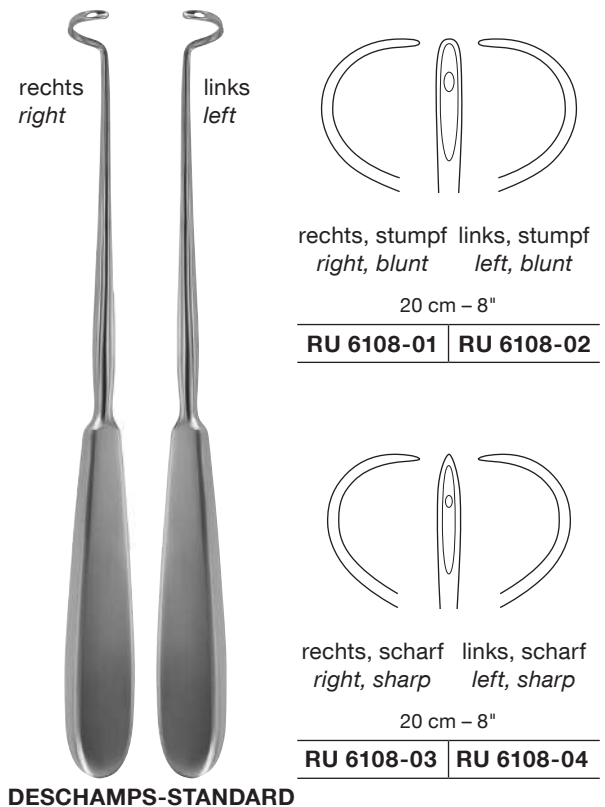
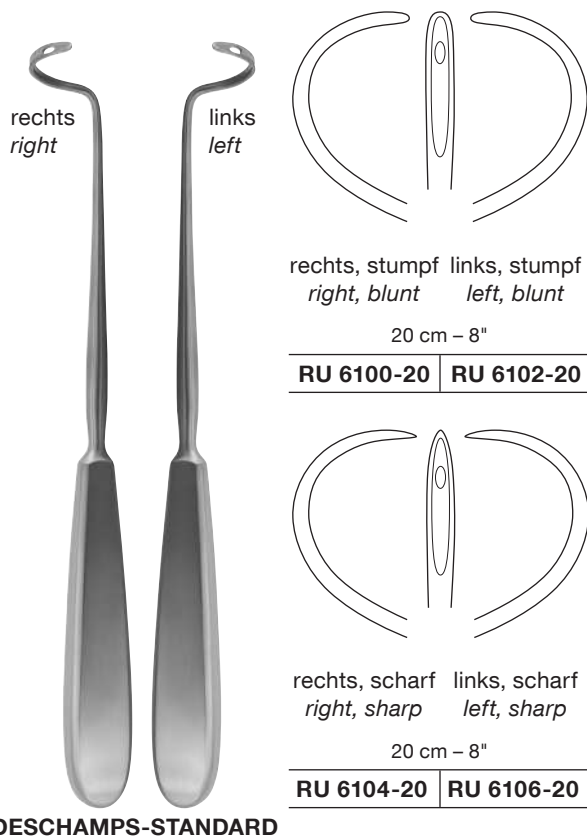
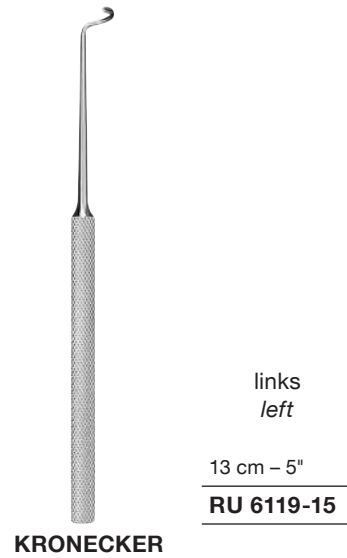
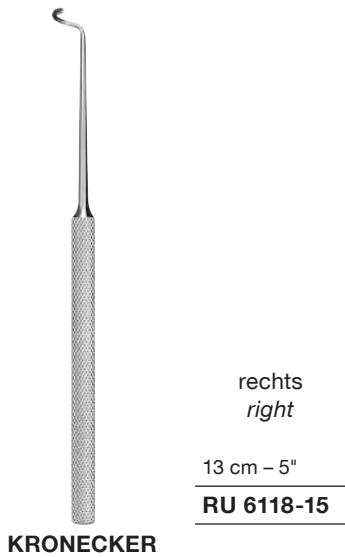

links = für die linke Hand rechts = für die rechte Hand
left = for left hand right = for right hand

Unterbindungsnadeln Ligature Needles



rechts
right

links
left



DESCHAMPS

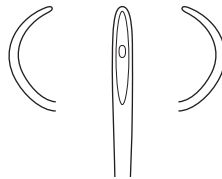

rechts, stumpf, klein links, stumpf, klein
right, blunt, small left, blunt, small

22,5 cm – 8¾"

RU 6105-01	RU 6105-02
-------------------	-------------------

rechts
right

links
left



DESCHAMPS

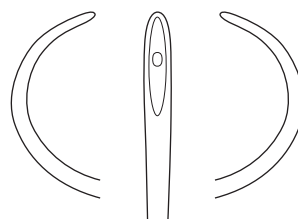

rechts, stumpf, links, stumpf,
right, blunt, left, blunt,

22,5 cm – 8¾"

RU 6105-03	RU 6105-04
-------------------	-------------------



links = für die linke Hand rechts = für die rechte Hand
left = for left hand right = for right hand

Unterbindungsnadeln Ligature Needles

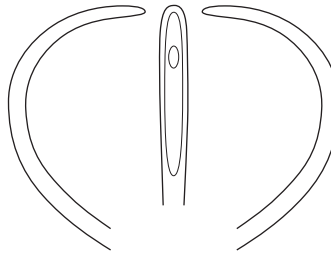

rechts, stumpf links, stumpf
right, blunt left, blunt

21 cm – 8¼"

RU 6110-21 | RU 6112-21

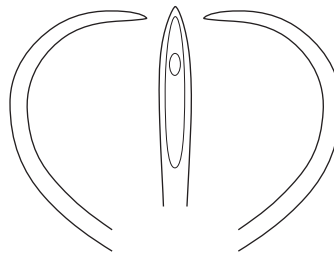

rechts, scharf links, scharf
right, sharp left, sharp

21 cm – 8¼"

RU 6114-21 | RU 6116-21

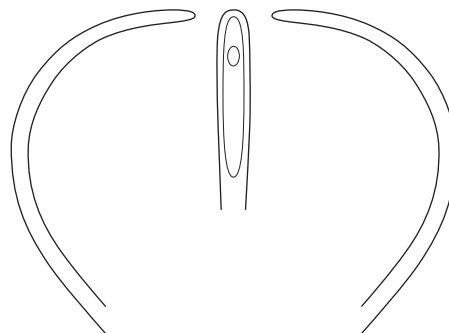
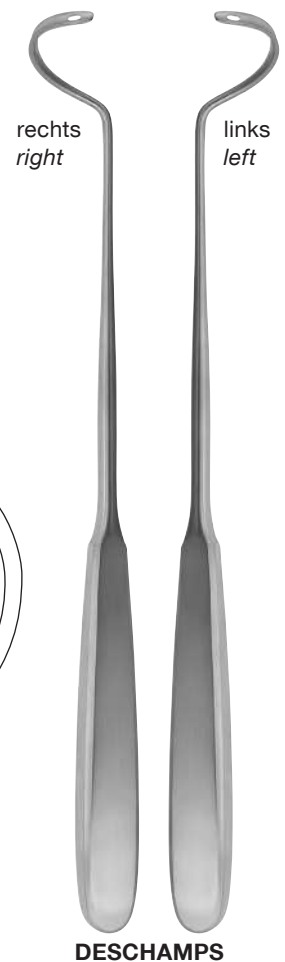

rechts, stumpf links, stumpf
right, blunt left, blunt

24 cm – 9½"

RU 6110-24 | RU 6112-24



links = für die linke Hand rechts = für die rechte Hand
left = for left hand right = for right hand

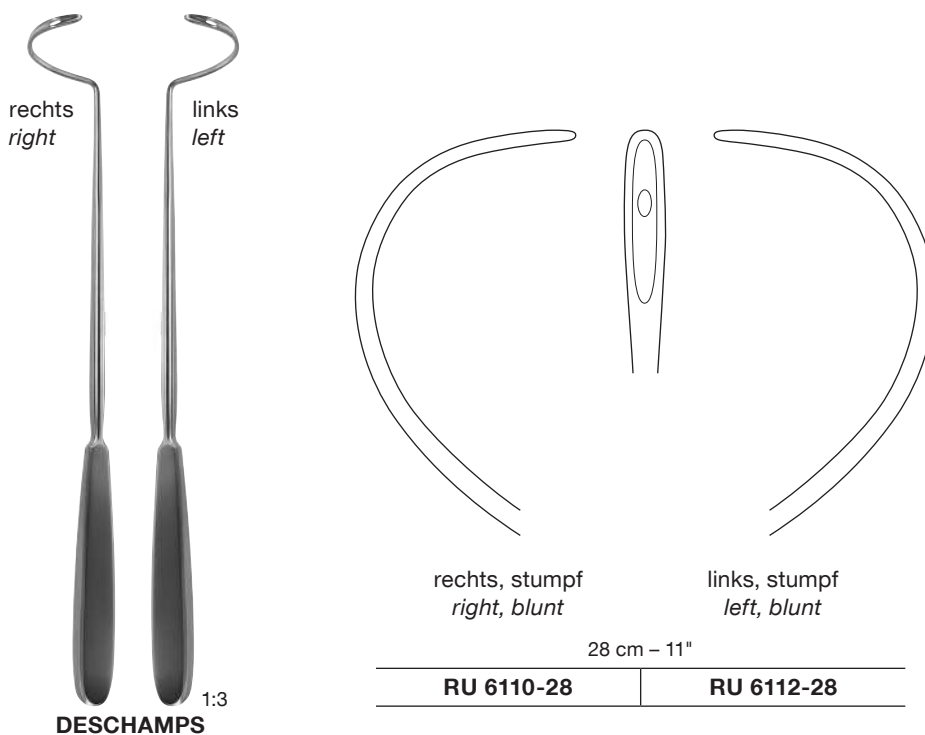

links = für die linke Hand rechts = für die rechte Hand
left = for left hand right = for right hand

Unterbindungsnadeln
Ligature Needles

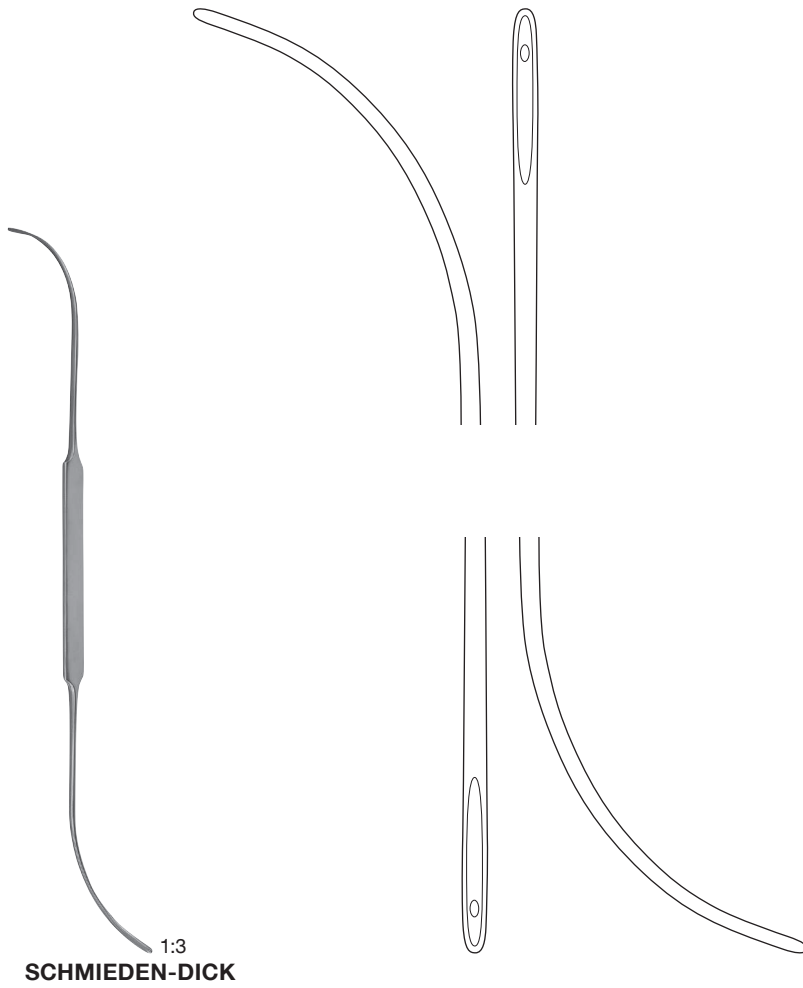

biegsam
malleable

30 cm – 11¾"

RU 6121-01

1:3
SCHMIEDEN-DICK

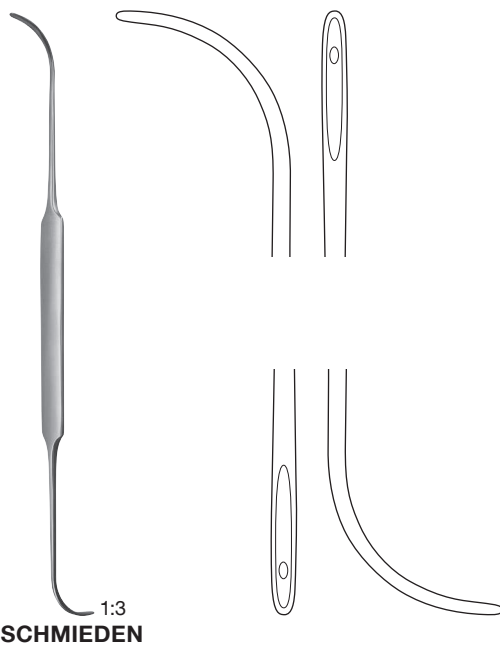

für die linke Hand
for left hand

24 cm – 9½"

RU 6121-21

1:3
SCHMIEDEN



biegsam
malleable

21 cm – 8¼"

RU 6123-20



18,5 cm – 7¼"

RU 6124-19

COOPER



REVERDIN



Fig. 1



Fig. 2



Fig. 3



Fig. 4

14,5 cm – 5¾"

RU 6126-01	RU 6126-02	RU 6126-03	RU 6126-04
-------------------	-------------------	-------------------	-------------------



REVERDIN



Fig. 1

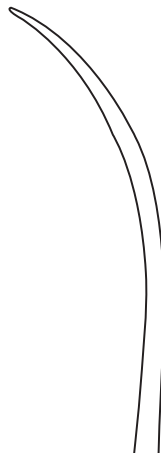

Fig. 2



Fig. 3

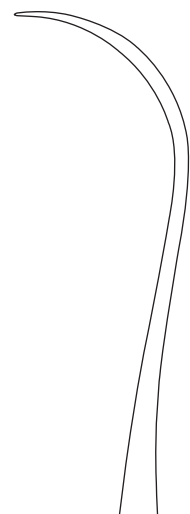

Fig. 4

19,5 cm – 7¾"

RU 6127-01	RU 6127-02	RU 6127-03	RU 6127-04
-------------------	-------------------	-------------------	-------------------



Fig. 1

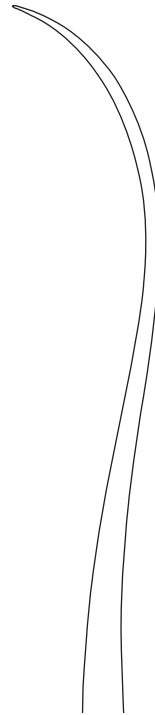

Fig. 2

22,5 cm – 8¾"

RU 6128-01	RU 6128-02
-------------------	-------------------



REVERDIN

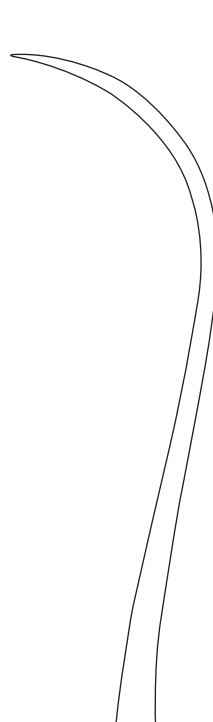

Fig. 3

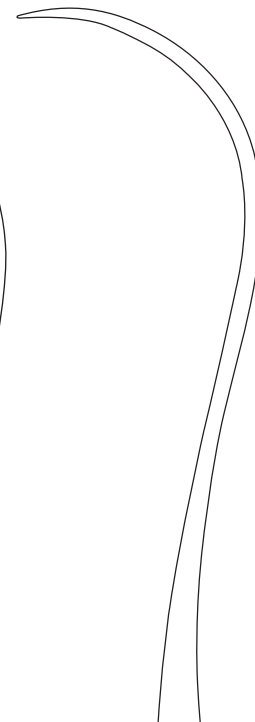

Fig. 4

22,5 cm – 8¾"

RU 6128-03	RU 6128-04
-------------------	-------------------



PAYR



gebogen
curved

19,5 cm – 7¾"

RU 6131-19



PAYR



gerade
straight

22 cm – 8¾"

RU 6130-22



PAYR

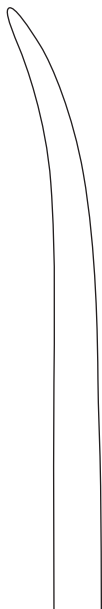

gebogen
curved

22 cm – 8¾"

RU 6131-22

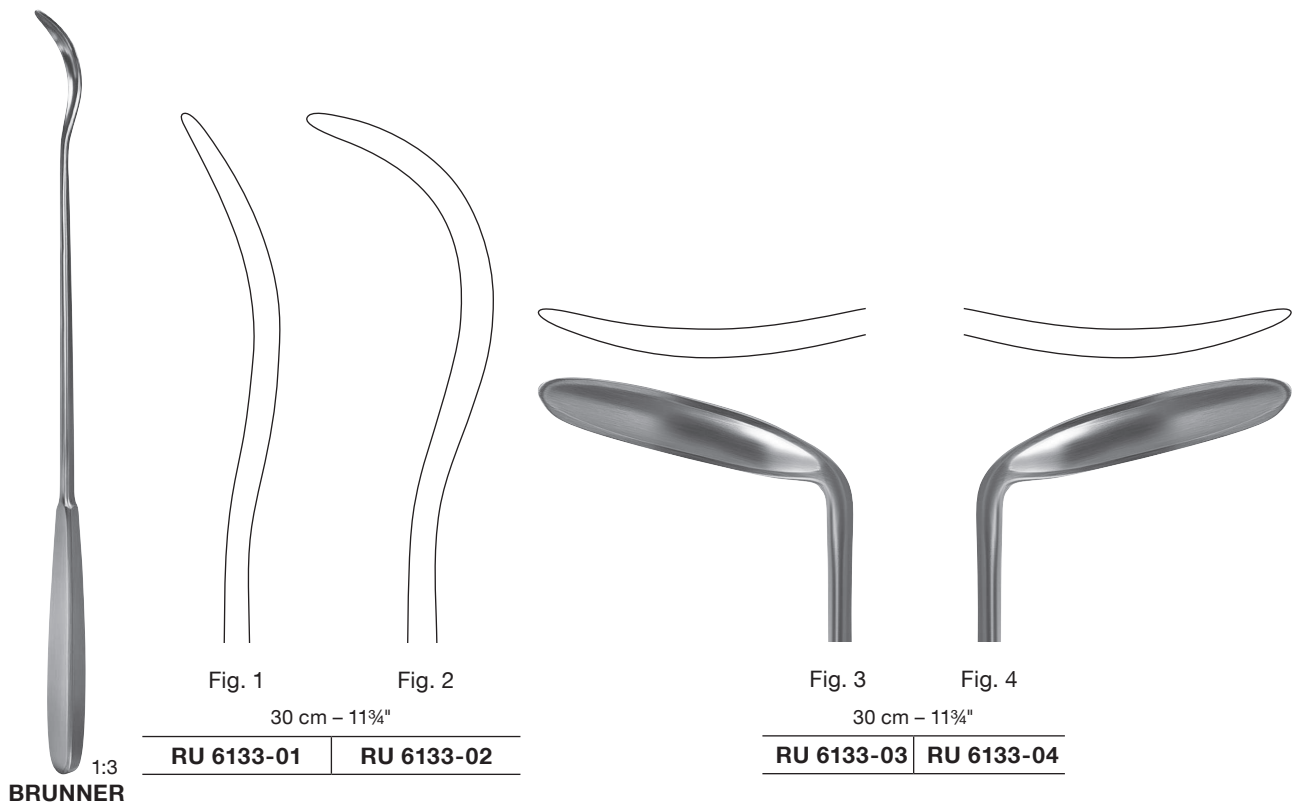
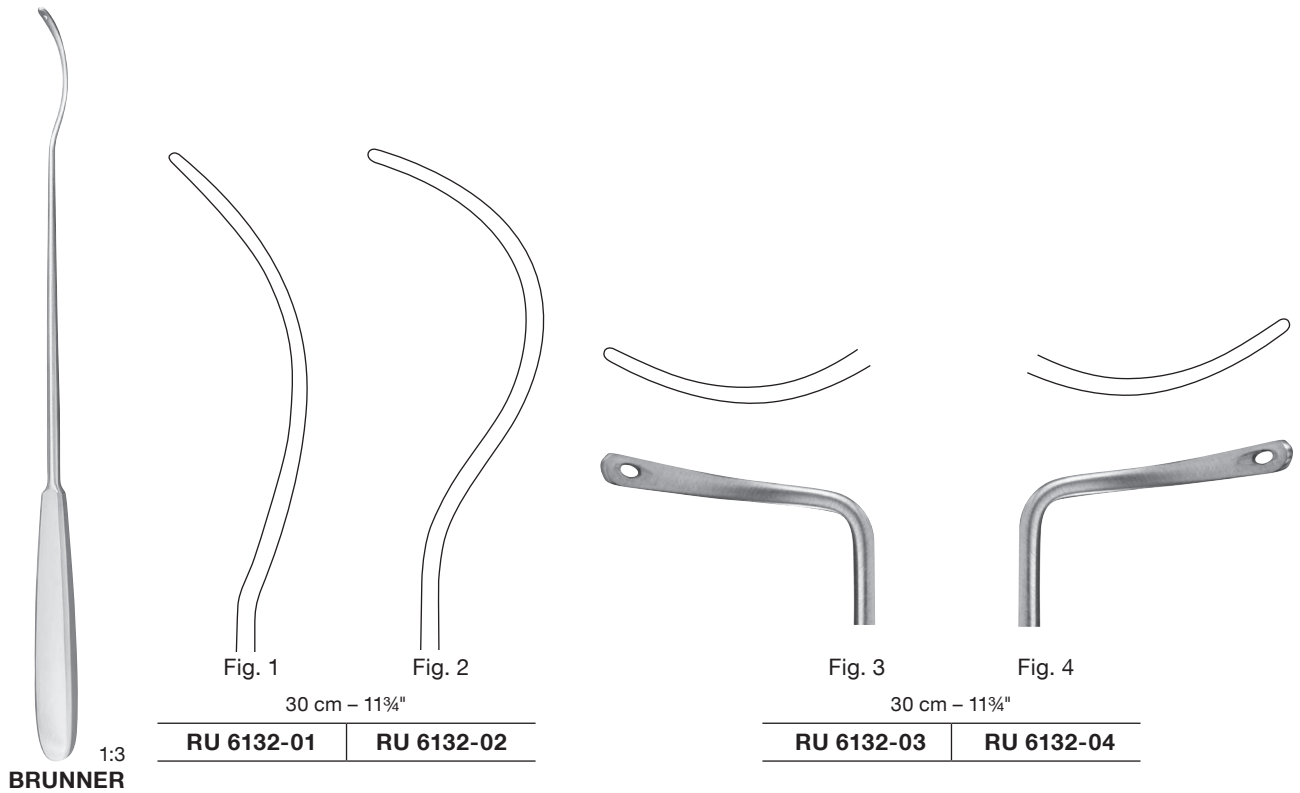

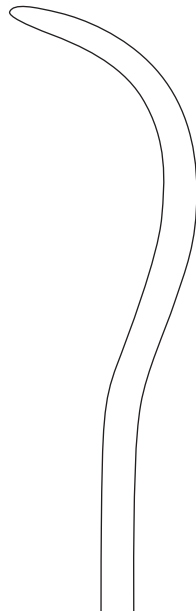

25,5 cm – 10"

RU 6134-25

KIRSCHNER



Aus Kunststoff-Hartgewebe
sterilisierbar im Autoklav

*Of plastic material,
can be sterilised in an
autoclave*



18 cm – 7"

RU 6136-18

25 cm – 10"

RU 6136-24

27 cm – 10½"

RU 6136-27

BRUNNER



19 cm – 7½"

RU 6139-19

SCHMIEDEN-PAYR



19 cm – 7½"

RU 6140-19

SCHMIEDEN



19,5 cm – 7¾"

RU 6141-19

KÖNIG



19,5 cm – 7¾"

RU 6142-19

KÖNIG



20 cm – 8"
RU 6143-20

KÖNIG



Fadenfänger
Suture hook

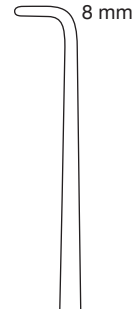

8 mm
23,5 cm – 9¼"
RU 6145-23

1:3
**MODELL WIEN
VIENNA PATTERN**



Fadengabel
Knot tier



23 cm – 9"
RU 6147-23



Klammeranlege- und
Entfernungszange
*Clip applying and
removing forceps*

12 cm – 4¾"

RU 6150-12

MICHEL

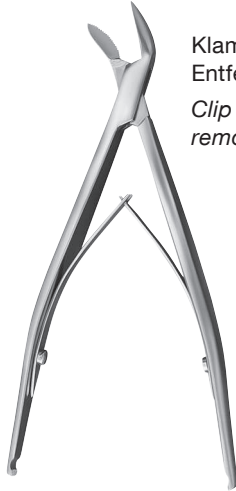

Klammeranlege- und
Entfernungszange
*Clip applying and
removing forceps*

12,5 cm – 5"

RU 6151-12

MICHEL



Klammeranlege- und
Entfernungszange
*Clip applying and
removing forceps*

13 cm – 5"

RU 6152-13

COLLIN

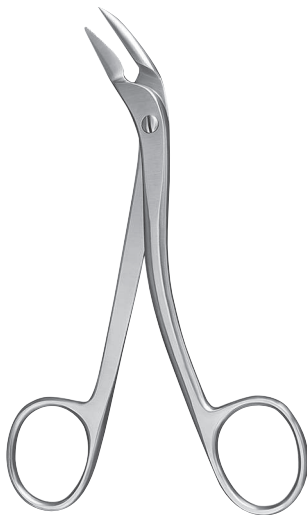

RICHTER-HEATH

14 cm – 5½"

RU 6153-14

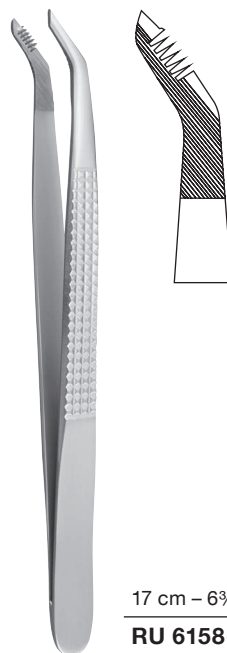

CHILD

17 cm – 6¾"

RU 6158-01

Klammeranlegepinzetten Clip Applying Forceps



12 cm – 4¾"

RU 6164-12

MICHEL



12 cm – 4¾"

RU 6165-12

WACHENFELDT



12,5 cm – 5"

RU 6168-12

HEGENBARTH

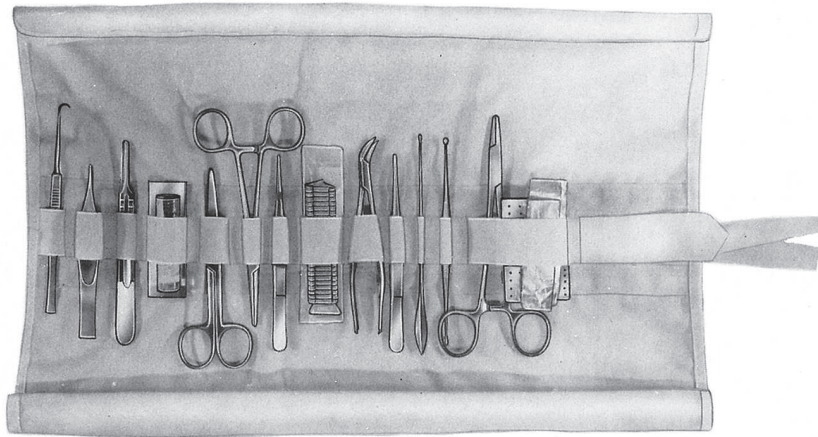

Chirurgisches Taschenbesteck komplett, bestehend aus:
Pocket instrument set complete, consisting of:

RU 6180-00

- 1 Arterienklemme Crile, 14 cm - 5½", gerade (RU 3074-14)
- 1 Hemostatic forceps, 14 cm - 5½", straight (RU 3074-14)
- 1 Häkchen Bergmann, 14 cm - 5½", scharf (RU 4469-14)
- 1 Hook Bergmann, 14 cm - 5½", sharp (RU 4469-14)
- 1 Skalpellgriff No. 4, 13,5 cm - 5¼" (RU 4850-04)
- 1 Scalpel handle No. 4, 13.5 cm - 5¼" (RU 4850-04)
- 1 Myrtenblattsonde, 13 cm - 5" (RU 4914-13)
- 1 Myrtle blade probe, 13 cm - 5" (RU 4914-13)
- 1 Doppellöffel Williger, 13,5 cm - 5¼", Ø 4,2/3,5 mm, scharf (RU 5368-12)
- 1 Double curette Williger, 13.5 cm - 5¼", Ø 4.2/3.5 mm, sharp (RU 5368-12)
- 1 Nadelhalter Mayo-Hegar, 16 cm - 6¼", gerade (RU 6000-16)
- 1 Needle holder Mayo-Hegar, 16 cm - 6¼", straight (RU 6000-16)
- 1 Nadeldose gelocht, 50 x 25 x 4,5 mm (RU 8910-50)
- 1 Needle case perforated, 50 x 25 x 4.5 mm (RU 8910-50)
- 1 Nadeldose gelocht, 75 x 25 x 4,5 mm (RU 8910-75)
- 1 Needle case perforated, 75 x 25 x 4.5 mm (RU 8910-75)
- 1 Chirurgische Schere, 13 cm - 5", spitz/stumpf, gerade (RU 1002-13)
- 1 Surgical scissors, 13 cm - 5", sharp/blunt, straight (RU 1002-13)
- 1 Anatomische Pinzette Standard, 13 cm - 5", gerade (RU 4000-13)
- 1 Dressing forceps Standard, 13 cm - 5", straight (RU 4000-13)
- 1 Chirurgische Pinzette Standard, 13 cm - 5", 1:2 Zähne, gerade (RU 4100-13)
- 1 Tissue forceps Standard, 13 cm - 5", 1:2 teeth, straight (RU 4100-13)
- 1 Splitterpinzette Feilchenfeld, 11,5 cm - 4½", gerade (RU 4320-11)
- 1 Splinter forceps Feilchenfeld, 11.5 cm - 4½", straight (RU 4320-11)
- 1 Wundklammerzängchen Michel modif., 12,5 cm - 5" (RU 6151-12)
- 1 Clip applying forceps Michel modif., 12.5 cm - 5" (RU 6151-12)
- 1 Rolltasche allein, im Autoklav sterilisierbar (RU 6180-00/01)
- 1 Pocket bag, only, autoclavable (RU 6180-00/01)
- 1 Metalletui allein (RU 8979-00)
- 1 Metal case, only, (RU 8979-00)

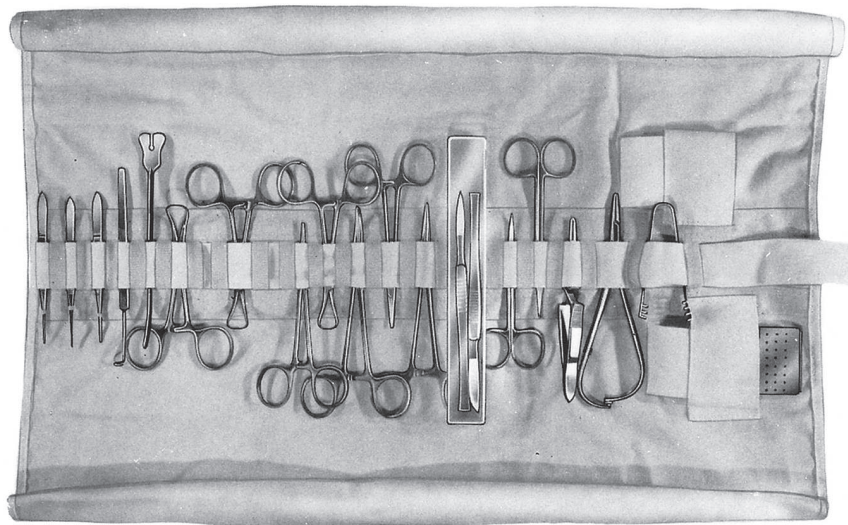

Venae Sectio Besteck komplett, bestehend aus:
Venae sectio set complete, consisting of:

RU 6185-00

- 1 Schere, 10,5 cm - 4¼", fein, gebogen (RU 1631-10)
- 1 Scissors, 10.5 cm - 4¼", delicate, curved (RU 1631-10)
- 1 Gefäßschere mit Knopf, 11,5 cm - 4½", gerade (RU 1705-11)
- 1 Coronary scissors with ball-end, 11.5 cm - 4½", straight (RU 1705-11)
- 1 Anatomische Pinzette, 10 cm - 4", fein, gerade (RU 4250-10)
- 1 Dressing forceps, 10 cm - 4", delicate, straight (RU 4250-10)
- 1 Chirurgische Pinzette, 10,5 cm - 4¼", fein, gerade, 1:2 Zähne (RU 4260-10)
- 1 Tissue forceps, 10.5 cm - 4¼", delicate, straight, 1:2 teeth (RU 4260-10)
- 1 Wundsperrer Finsen, 7 cm - 2¾", feststellbar, scharf (RU 4642-07)
- 1 Retractor Finsen, 7 cm - 2¾", lockable, sharp (RU 4642-07)
- 1 Hohlsonde Doyen, 14,5 cm - 5¾", gebogen (RU 4911-14)
- 1 Probe Doyen, 14.5 cm - 5¾", curved (RU 4911-14)
- 1 Nadelhalter Mathieu, 14 cm - 5½", gerade (RU 6040-14)
- 1 Needle holder Mathieu, 14 cm - 5½", straight (RU 6040-14)
- 1 Unterbindungsnadel Kronecker, 13 cm - 5", links (RU 6118-15)
- 1 Ligature needle Kronecker, 13 cm - 5", left (RU 6118-15)
- 1 Klammeranlegezange Hegenbarth, 12,5 cm - 5", 2:3 Zähne (RU 6168-12)
- 1 Clip applying forceps Hegenbarth, 12.5 cm - 5", 2:3 teeth (RU 6168-12)
- 1 Chirurgische Pinzette Micro-Adson-Bierner, 12 cm - 4¾", fein, gerade, 1:2 Zähne (RU 4131-12)
- 1 Tissue forceps Micro-Adson-Bierner, 12 cm - 4¾", delicate, straight, 1:2 teeth (RU 4131-12)
- 2 Arterienklemme Halstead-Mosquito, 12,5 cm - 5", gebogen (RU 3101-12)
- 2 Hemostatic forceps Halstead-Mosquito, 12.5 cm - 5", gebogen (RU 3101-12)
- 2 Arterienklemme Halstead-Mosquito, 12,5 cm - 5", gerade, 1:2 Zähne (RU 3110-12)
- 2 Hemostatic forceps Halstead-Mosquito, 12.5 cm - 5", straight, 1:2 teeth (RU 3110-12)
- 3 Tuchklemme Backhaus, 9 cm - 3½" (RU 3600-09)
- 3 Towel forceps Backhaus, 9 cm - 3½" (RU 3600-09)
- 1 Anatomisches Skalpell, Fig. 1, spitz (RU 4858-01)
- 1 Dissecting Scalpel, Fig. 1, pointed (RU 4858-01)
- 1 Anatomisches Skalpell, Fig. 6, spitz (RU 4858-06)
- 1 Dissecting Scalpel, Fig. 6, pointed (RU 4858-06)
- 1 Nadeldose gelocht, 50 x 25 x 4,5 mm (RU 8910-50)
- 1 Needle case perforated, 50 x 25 x 4.5 mm (RU 8910-50)
- 1 Rolltasche allein, im Autoklav sterilisierbar (RU 6180-00/01)
- 1 Pocket bag, only, autoclavable (RU 6180-00/01)
- 1 Metalletui allein (RU 8979-00)
- 1 Metal case, only, (RU 8979-00)



Gipsmesser
Plaster knives

20 cm – 8"
RU 6210-20

HOPKINS



Gipsmesser
Plaster knives

18 cm – 7"
RU 6212-18

ESMARCH



Gipsmesser
Plaster knives

18,5 cm – 7¼"
RU 6214-18

REINER



Gipssäge
Plaster saw

15 cm – 6"
RU 6225-14

ENGEL



Gipsspreizer
Plaster spreader

28 cm – 11"
RU 6230-28

HENNING

1:3



Gipsspreizer
Plaster spreader

23 cm – 9"

RU 6234-23

1:3

**MODELL USA
USA PATTERN**



Gipsabreißzange
Plaster breaker

18 cm – 7"

RU 6240-18

24 cm – 9½"

RU 6240-24

WOLFF



Gipsschere
Plaster shears

STILLE

24 cm – 9½"

RU 2835-24

1:3



Gipsschere
Plaster shears

Messer mit verstärktem Rücken
Blade with reinforced back

23 cm – 9"

RU 2840-23

26 cm – 10¼"

RU 2840-26

37 cm – 14½"

RU 2840-37

STILLE

1:3

Gipsverband-Instrumente Plaster cast instruments



Gipssägen mit oszillierenden Sägeblättern
Plaster saws with oscillating saw blades



inkl. Sägeblätter
incl. saw blades
RU 6220-83
RU 6220-85

Standard
Standard

RU 6220-20



inkl. Sägeblätter
incl. saw blades
RU 6220-83
RU 6220-85

Akku
Accu

RU 6220-22



inkl. Sägeblätter
incl. saw blades
RU 6220-84
RU 6220-85

ECO-Version
ECO Version

RU 6220-24

Zubehör für RU 6220-22 Accessories for RU 6220-22



Akku (1700 mAh)
für oszillierender Gipssäge (RU 6220-22)
*Battery, rechargeable, (1700 mAh)
for oscillating plaster saw (RU 6220-22)*

RU 6220-41



Schnell-Ladegerät für Akku
(RU 6220-41)
*Quick recharger for accu
(RU 6220-41)*

RU 6220-42

Zubehör Accessories

Koffer für oszillierende Gipssägen
(RU 6220-20 Standard, RU 6220-24 ECO-Version)
*Case for oscillating plaster saws
(RU 6220-20 Standard, RU 6220-24 ECO-Version)*

RU 6220-31

Koffer für oszillierende Gipssäge
(RU 6220-22 ACCU)
*Case for oscillating plaster saw
(RU 6220-22 ACCU)*

RU 6220-32

Sägeblätter (autoklavierbar)
Material: rostfreier Edelstahl
Saw blades (autoclavable)
Material: stainless steel

Rundsägeblatt
Round saw blade

	Gips Plaster	Synthetik Syntetic
Ø 44 mm	RU 6220-80	RU 6220-81
Ø 50 mm	RU 6220-82	RU 6220-83
Ø 65 mm	RU 6220-84	RU 6220-85



Segment-Sägeblatt
Segment saw blade

	Gips Plaster	Synthetik Syntetic
Ø 65 mm	RU 6220-86	RU 6220-87



Tailen-Sägeblatt
Wasted saw blade

	Gips Plaster	Synthetik Syntetic
Ø 65 mm	RU 6220-88	RU 6220-89



Tiefensägeblatt
Deep saw blade

	Gips Plaster	Synthetik Syntetic
Ø 70 mm	RU 6220-91	RU 6220-92



Gipssäge, komplett mit Staupsauger, bestehend aus:
Plaster saw, complete with vacuum cleaner consisting of: **RU 6220-51**

- 1 Gipssäge, oszillierend (RU 6220-20 inkl. RU 6220-83 und RU 6220-85)
- 1 Plaster saw, oscillating (RU 6220-20 incl. RU 6220-83 and RU 6220-85)
- 1 Sauger (RU 6220-60)
- 1 Vacuum cleaner (RU 6220-60)
- 1 Schlauch (RZ6220-62)
- 1 Tube (RZ6220-62)
- 1 Schlauchhalter (RZ6220-70)
- 1 Hose clamp (RZ6220-70)
- 1 Absaugglocke (RZ6220-68)
- 1 Dust removal unit (RZ6220-68)
- 1 Adapterkabel (RZ6220-73)
- 1 Adaptercable (RZ6220-73)
- 1 Werkzeug (RZ6220-71)
- 1 Tool (RZ6220-71)

Staubsauger ohne Zubehör
Vacuum cleaner without accessories

RU 6220-60

Optional:

- Aufhängung mit Griff, höhenverstellbar (RZ6220-69), nur für RU 6220-20 und RU 6220-22 geeignet
- Magnetische Ablage (RZ6220-72)

Optional:

- Hanging kit with handle, height adjustable (RZ6220-69), suitable only for RU 6220-20 and 6220-22
- Magnetic placement (RZ6220-72)



Darm- und Gewebefasszangen	<i>Intestinal and Tissue Grasping Forceps</i>	AS 1 - 6
Darmklemmen	<i>Intestinal Clamps</i>	AS 7 - 13
Magenklemmen	<i>Stomach Clamps</i>	AS 14
Magen- und Darmquetschklemmen	<i>Intestinal and Pylorus Clamps</i>	AS 15
Magen- und Darm-Zwillingsklemmen	<i>Stomach and Intestinal Twin Clamps</i>	AS 16
Anastomosenklemmen	<i>Anastomosis Clamps</i>	AS 17
Rektum-Anastomosenklemmen	<i>Sigmoid Anastomosis Clamps</i>	AS 18 - 19
Rektum-Spekula	<i>Rectal Specula</i>	AS 20 - 21
Rektoskope	<i>Rectoscopes</i>	AS 22 - 23
Analspreizer	<i>Rectal Spreader</i>	AS 24
Rektum-Biopsiefasszange	<i>Rectal Biopsy Forceps</i>	AS 25
Hämorrhoidalzangen	<i>Haemorrhoidal Forceps</i>	AS 26 - 27
Hämorrhoidal-Ligatoren	<i>Haemorrhoidal Ligators</i>	AS 28 - 30
Gallenkanal-Klemmzangen	<i>Gall Duct Forceps</i>	AS 31 - 32
Gallenkanal Instrumente	<i>Gall Duct Instruments</i>	AS 33 - 34
Nierenklemmen	<i>Kidney Clamps</i>	AS 35
Nierensteinzangen	<i>Kidney Stone Forceps</i>	AS 36
Blasenwundspreizer	<i>Bladder Retractors</i>	AS 37 - 38
Urologie-Instrumente	<i>Urology Instruments</i>	AS 39 - 43

Darm- und Gewebefasszangen Intestinal and Tissue Grasping Forceps

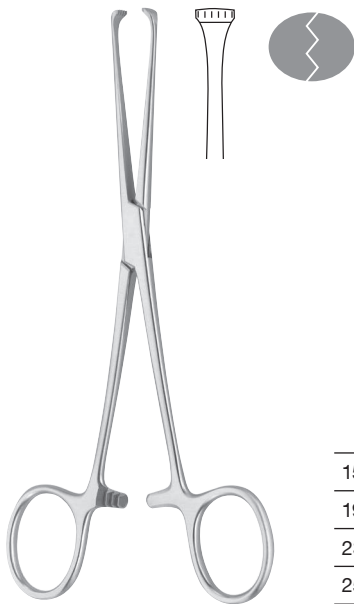

ALLIS

	4 : 5 Zähne 4 : 5 teeth	5 : 6 Zähne 5 : 6 teeth
15 cm – 6"	RU 6500-15	RU 6502-15
19 cm – 7½"	–	RU 6502-19
23 cm – 9"	–	RU 6502-23
25 cm – 10"	–	RU 6502-25

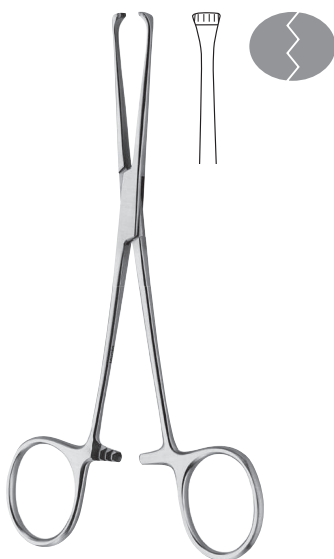

BABY-ALLIS

	4 : 5 Zähne 4 : 5 teeth
12 cm – 4¾"	RU 6504-12
14 cm – 5½"	RU 6504-14

Darm- und Gewebefasszangen Intestinal and Tissue Grasping Forceps



ALLIS-ATRAUMA

16 cm – 6¼"	RU 6505-16
20 cm – 8"	RU 6505-20
22 cm – 8¾"	RU 6505-22
25 cm – 10"	RU 6505-25
30 cm – 11¾"	RU 6505-30



ALLIS-ADAIR

15 cm – 6"	RU 6506-15
------------	-------------------



BOYS-ALLIS

15 cm – 6"	RU 6508-15
------------	-------------------



LOCKWOOD-ALLIS

	4 : 5 Zähne 4 : 5 teeth
16 cm – 6¼"	RU 6509-16
20 cm – 8"	RU 6509-20

Darm- und Gewebefasszangen Intestinal and Tissue Grasping Forceps



THOMS-ALLIS

6 : 7 Zähne
6 : 7 teeth

20 cm – 8"

RU 6510-20



JUDD-ALLIS

3 : 4 Zähne
3 : 4 teeth

15 cm – 6"

RU 6512-15

19 cm – 7½"

RU 6512-19

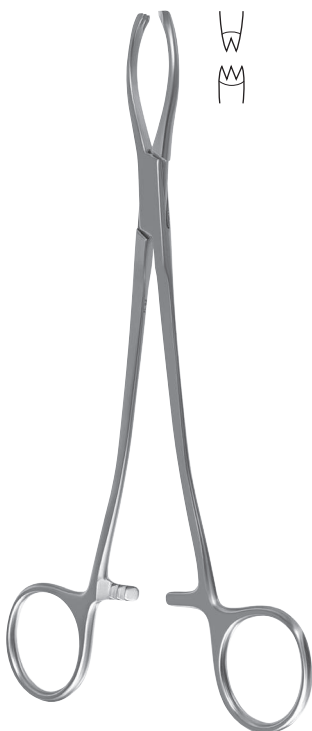

LITTLEWOOD

2 : 3 Zähne
2 : 3 teeth

18,5 cm – 7¼"

RU 6513-18



LOCKWOOD

gefenstert
fenestrated

20 cm – 8"

RU 6515-20

Darm- und Gewebefasszangen Intestinal and Tissue Grasping Forceps



9 mm

DE BAKEY Zahnung
DE BAKEY Serration

16 cm – 6¼"	RU 6517-16
20 cm – 8"	RU 6517-20

BABCOCK-ATRAUMA

9 mm

Standardmodell
Standard pattern

16 cm – 6¼"	RU 6518-16
18 cm – 7"	RU 6518-18
20 cm – 8"	RU 6518-20
24 cm – 9½"	RU 6518-24

BABCOCK

9 mm 12 mm

16 cm – 6¼"	20 cm – 8"
TC RU 6519-16	RU 6519-20

BABCOCK

Darm- und Gewebefasszangen Intestinal and Tissue Grasping Forceps

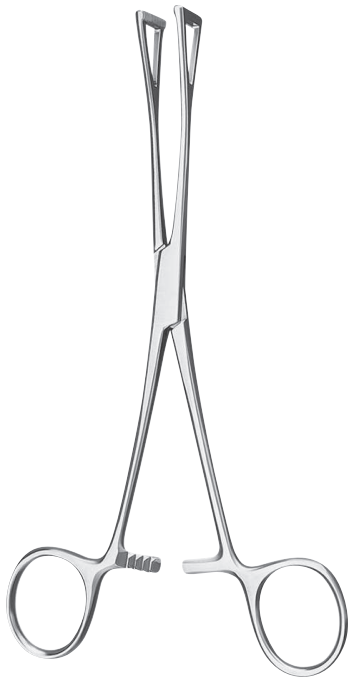

DUVAL

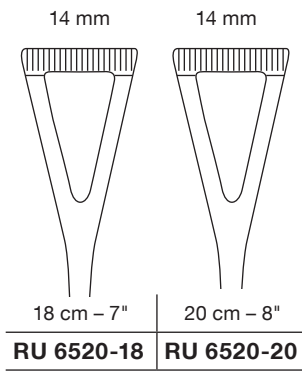

COLLIN

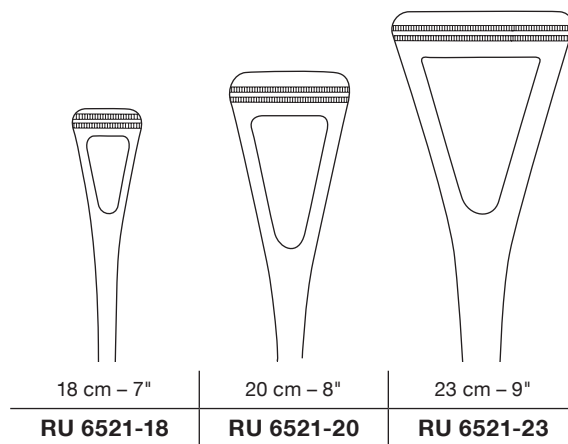

Darm- und Gewebefasszangen Intestinal and Tissue Grasping Forceps

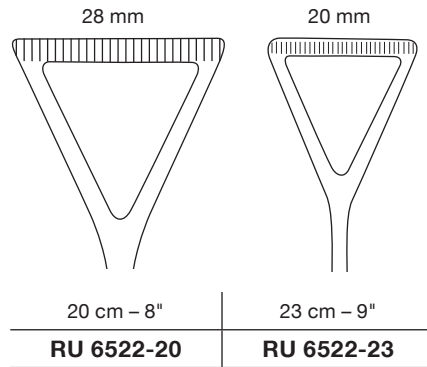
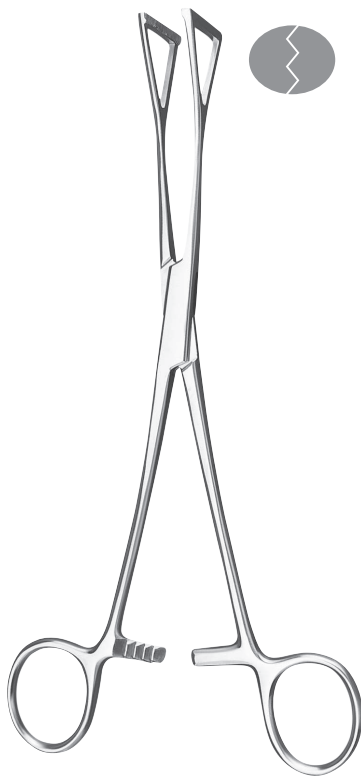

DUVAL

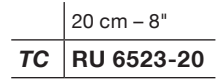
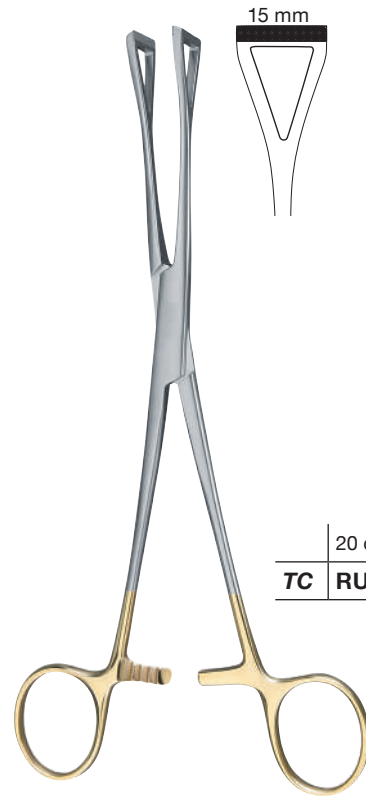

DUVAL

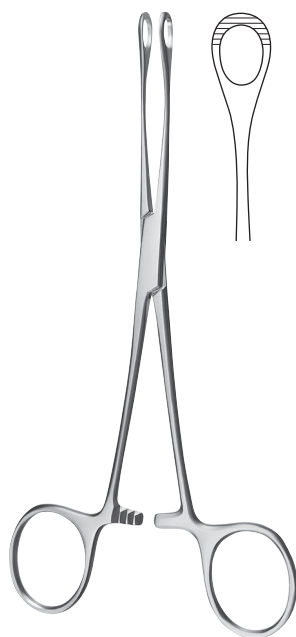

gerade
straight

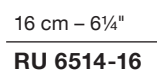

WILLIAMS

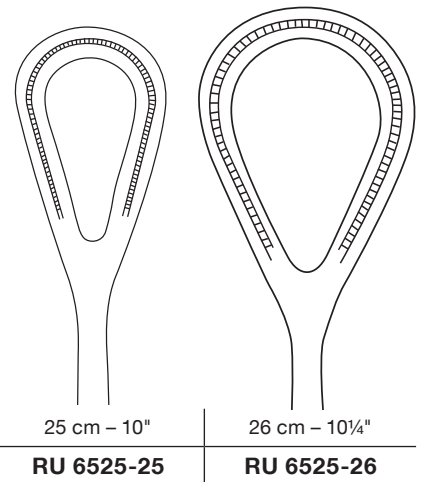



BABY-DOYEN

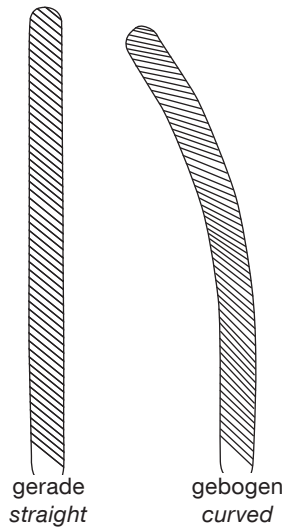

18 cm – 7"

RU 6530-18

RU 6531-18



DOYEN

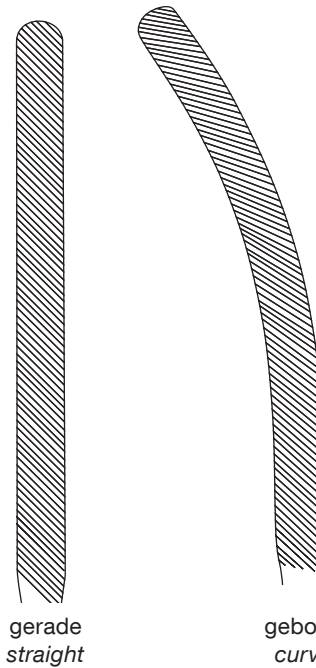

21 cm – 8¼"

RU 6530-21

RU 6531-21

23 cm – 9"

RU 6530-23

RU 6531-23



DE BAKEY Zahnung
DE BAKEY Serration

gerade
straight

DOYEN-ATRAUMA



13 cm – 5"

RU 6534-13

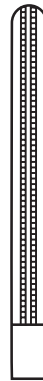

16 cm – 6¼"

RU 6534-16



18 cm – 7"

RU 6534-18



21 cm – 8¼"

RU 6534-21

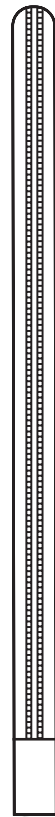

23 cm – 9"

RU 6534-23



DE BAKEY Zahnung
DE BAKEY Serration

gebogen
curved

DOYEN-ATRAUMA

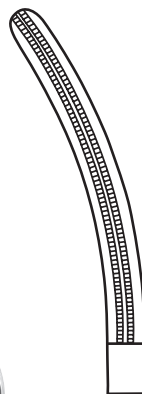

13 cm – 5"

RU 6535-13

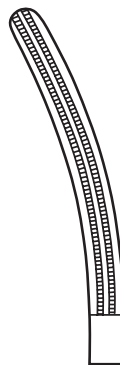

16 cm – 6¼"

RU 6535-16

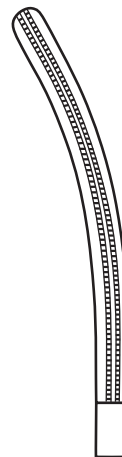

18 cm – 7"

RU 6535-18



21 cm – 8¼"

RU 6535-21

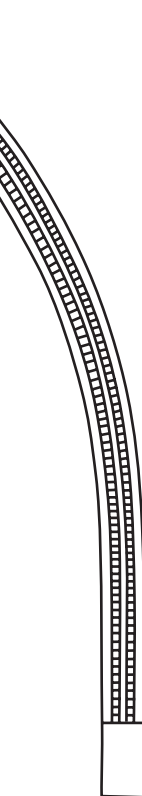

23 cm – 9"

RU 6535-23



MAYO-ROBSON



gerade
straight

21 cm – 8¼"

RU 6540-21

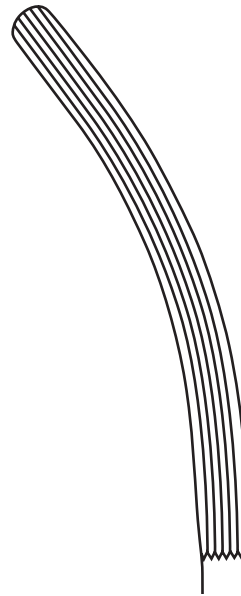

gebogen
curved

21 cm – 8¼"

RU 6541-21



gerade
straight

23 cm – 9"

RU 6540-23

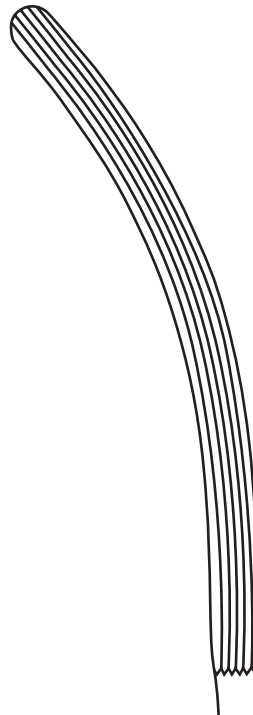

gebogen
curved

23 cm – 9"

RU 6541-23

Darmklemmen
Intestinal Clamps



MAYO-ROBSON

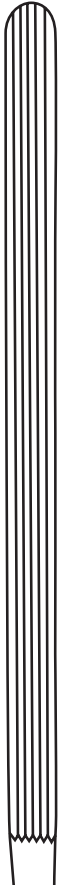

gerade
straight

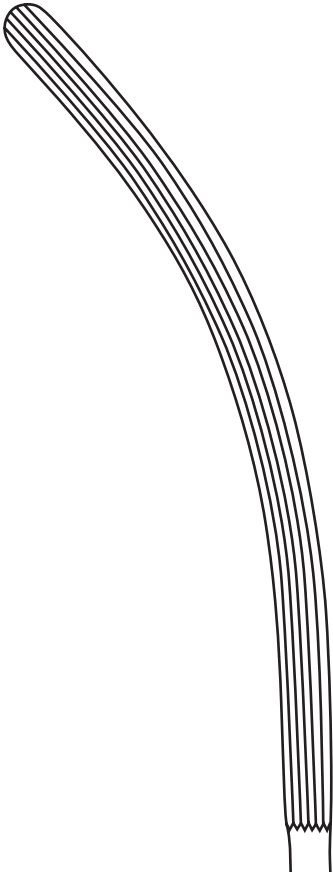

gebogen
curved

25 cm - 10"

RU 6540-25	RU 6541-25
-------------------	-------------------



MAYO-ROBSON ATRAUMA



DE BAKEY Zahnung
DE BAKEY Serration

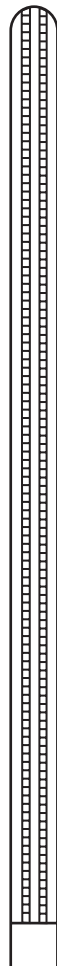

gerade
straight

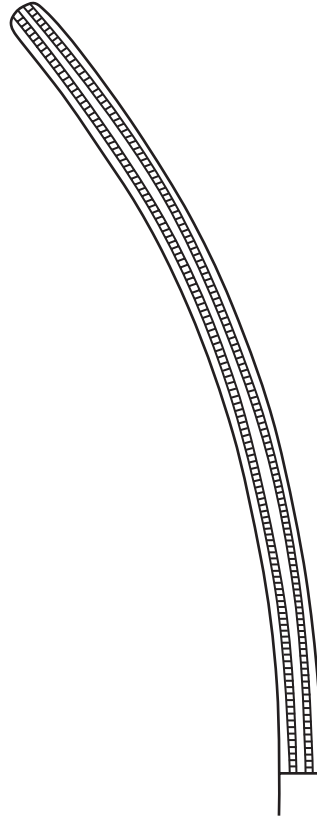

gebogen
curved

25 cm – 10"

RU 6542-25

RU 6543-25



BABY-KOCHER



gerade, sehr elastisch
straight, very elastic blades

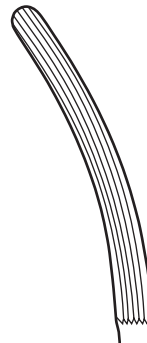

gebogen, sehr elastisch
curved, very elastic blades

13 cm – 5"

RU 6550-13

RU 6551-13

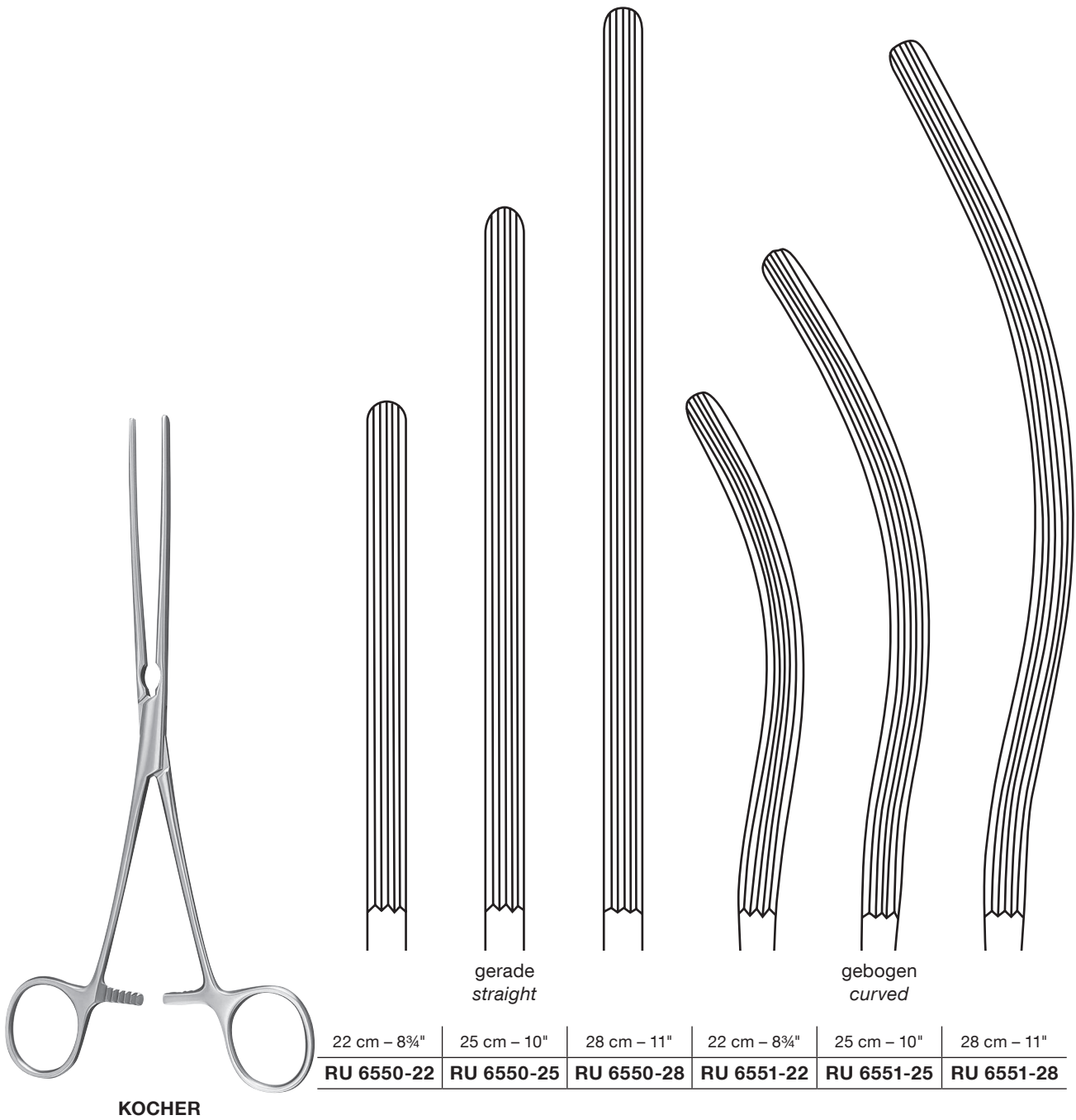



DE BAKEY Zahnung
DE BAKEY Serration



KOCHER-ATRAUMA

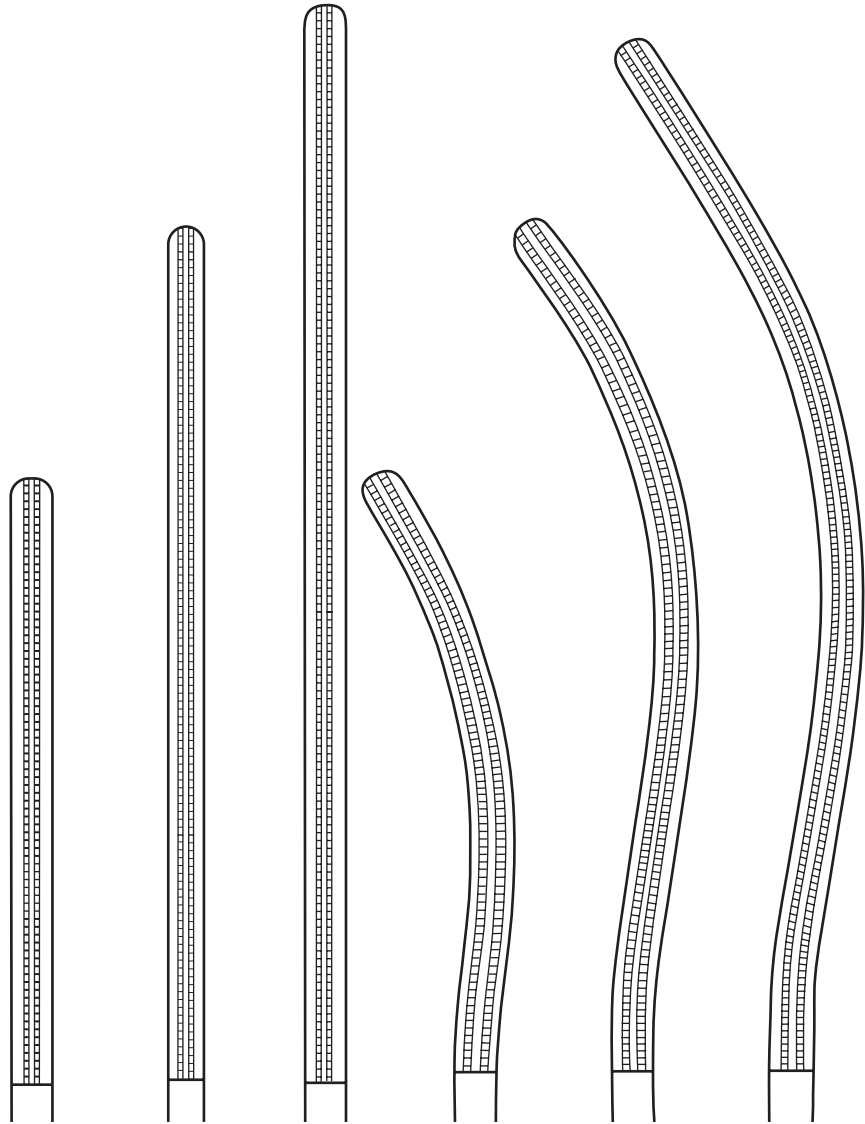

gerade
straight

gebogen
curved

22 cm – 8¾"	25 cm – 10"	28 cm – 11"	22 cm – 8¾"	25 cm – 10"	28 cm – 11"
RU 6552-22	RU 6552-25	RU 6552-28	RU 6553-22	RU 6553-25	RU 6553-28

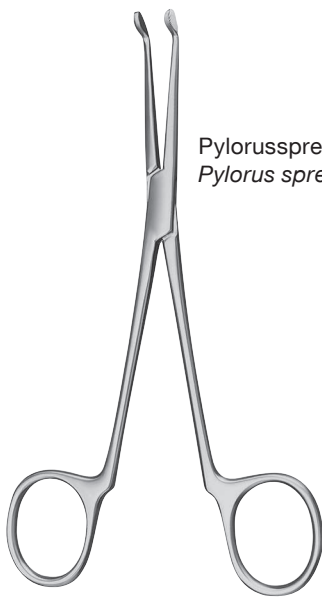

Pylorusspreizer
Pylorus spreader

BENSON



gebogen, gerieft
curved, serrated

15,5 cm – 6"

RU 6557-15



1 : 2 Zähne
1 : 2 teeth

ALLEN



gerade
straight

15,5 cm – 6"

RU 6558-15

20 cm – 8"

RU 6558-20

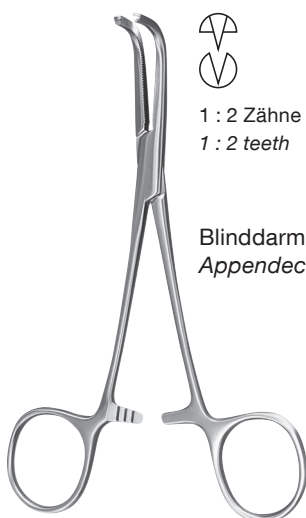

1 : 2 Zähne
1 : 2 teeth

Blinddarmklemme
Appendectomy clamp

KLEINSCHMIDT



gebogen
curved

12 cm – 4¾"

RU 6559-12

Magen- und Darmquetschklemmen Intestinal and Pylorus Clamps



PAYR

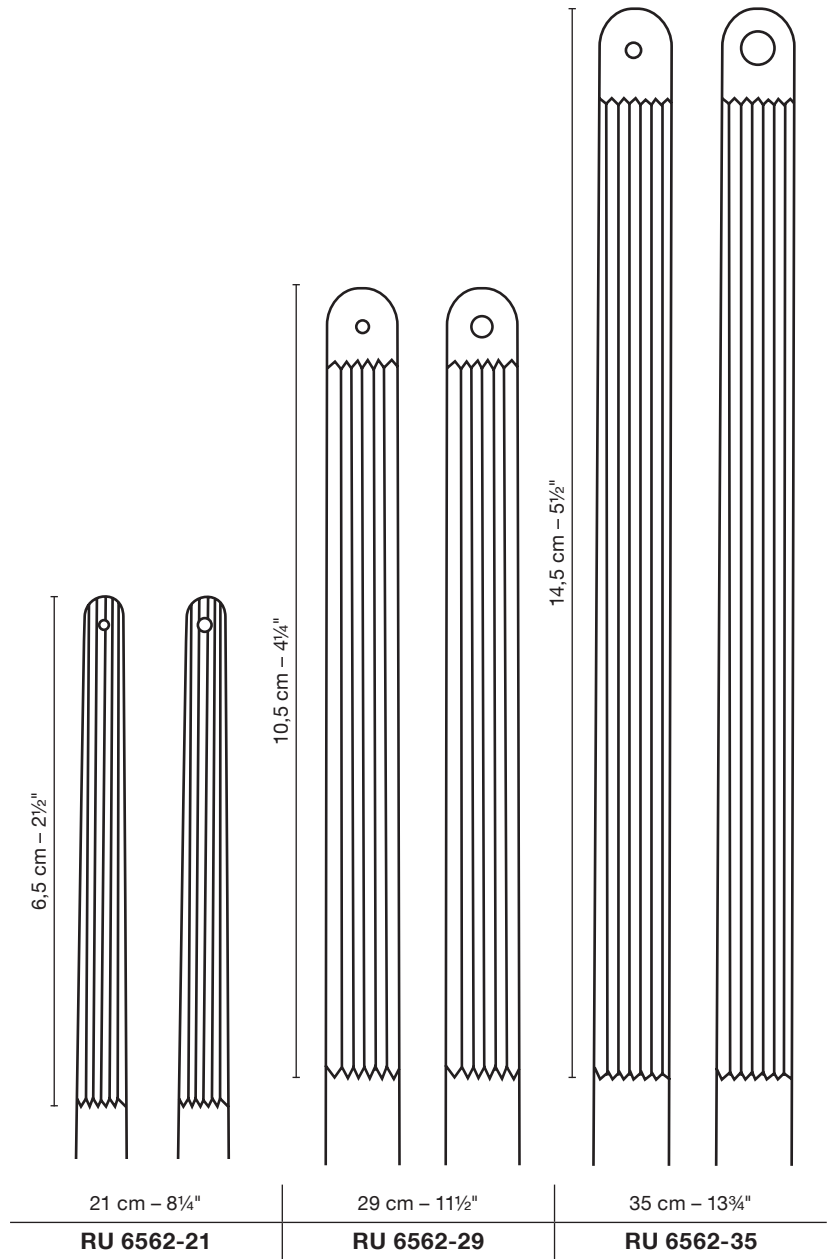

Magen- und Darm-Zwillingsklemmen Stomach and Intestinal Twin Clamps



1:3



1:3

LANE



gerade
straight

30 cm – 11¾"

RU 6570-30

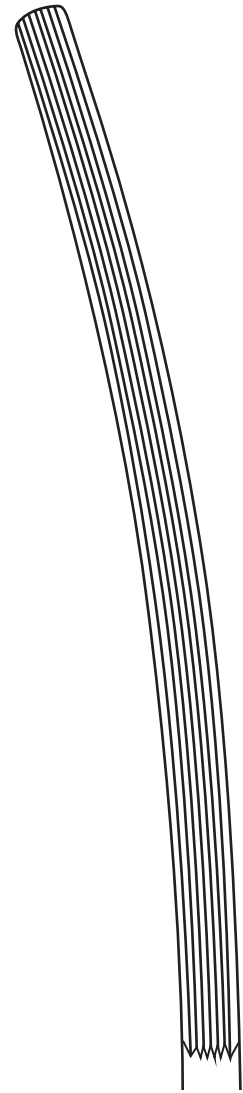

gebogen
curved

30 cm – 11¾"

RU 6571-30

Anastomosenklemmen Anastomosis Clamps



Schließzange
Closing forceps

26 cm – 10¼"
RU 6580-00

DE MARTEL-WOLFSON

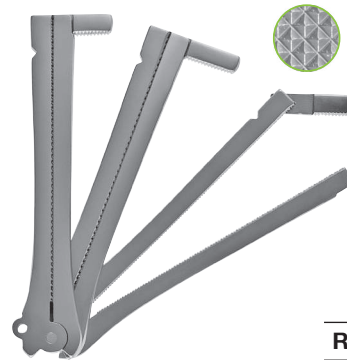

DE MARTEL-WOLFSON

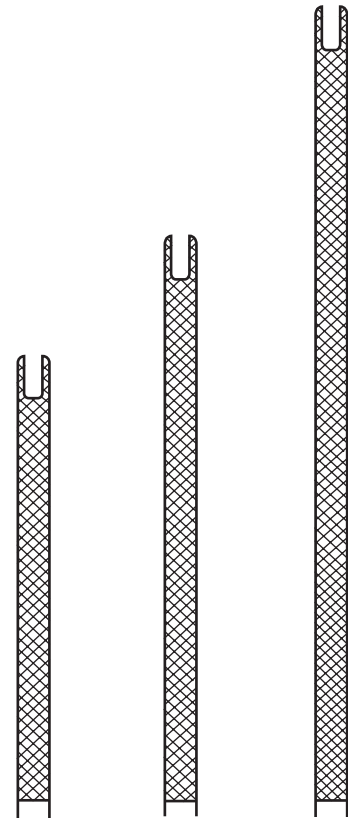

Satz von 3 Klemmen
Set of 3 clamps

5 cm – 2"	7 cm – 2¾"	10 cm – 4"
RU 6580-05	RU 6580-07	RU 6580-10

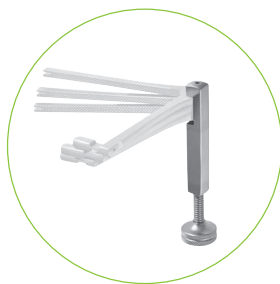

Klemmenhalter
für RU 6580-05, -07, -10
Clamp holder
for RU 6580-05, -07, -10



8,5 cm – 3¼" | **RU 6580-20**
23 cm – 9" | **RU 6580-23**

DE MARTEL-WOLFSON

Rektum-Anastomosenklemmen Sigmoid Anastomosis Clamps

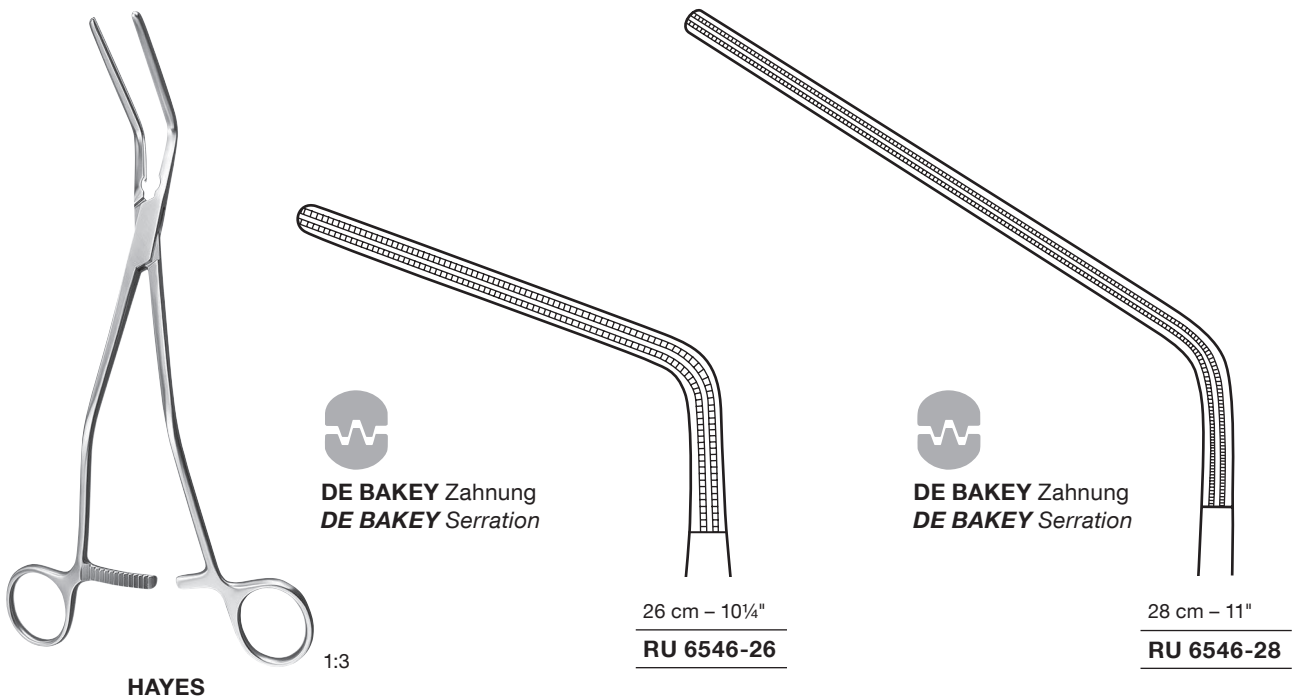
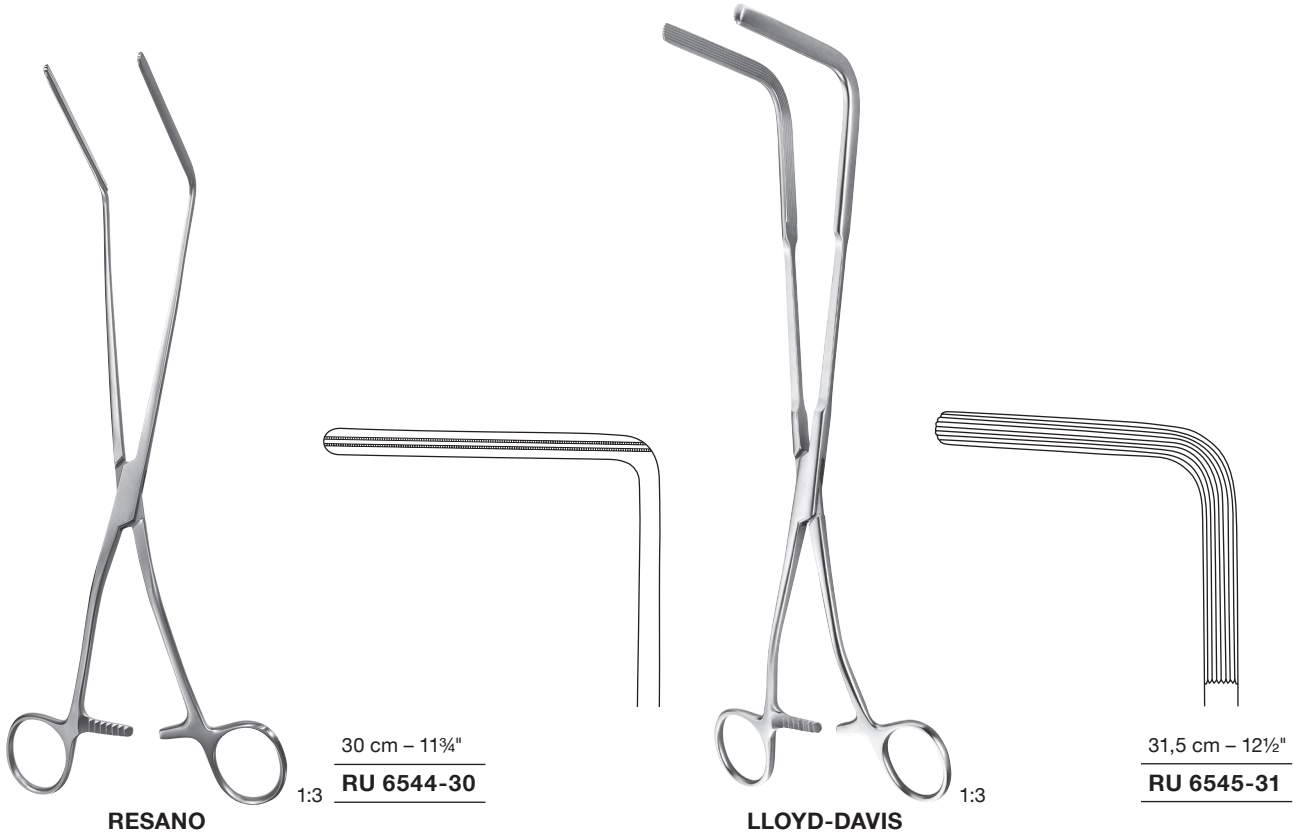

Rektum-Anastomosenklemmen

Sigmoid Anastomosis Clamps



DE BAKEY Zahnung
DE BAKEY Serration

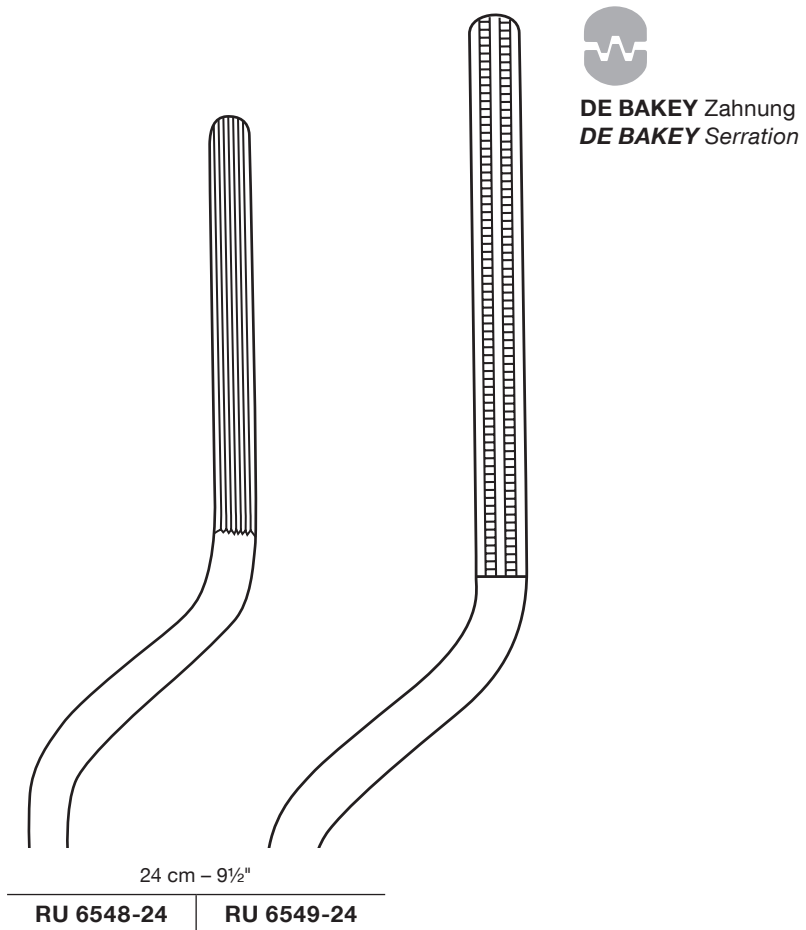
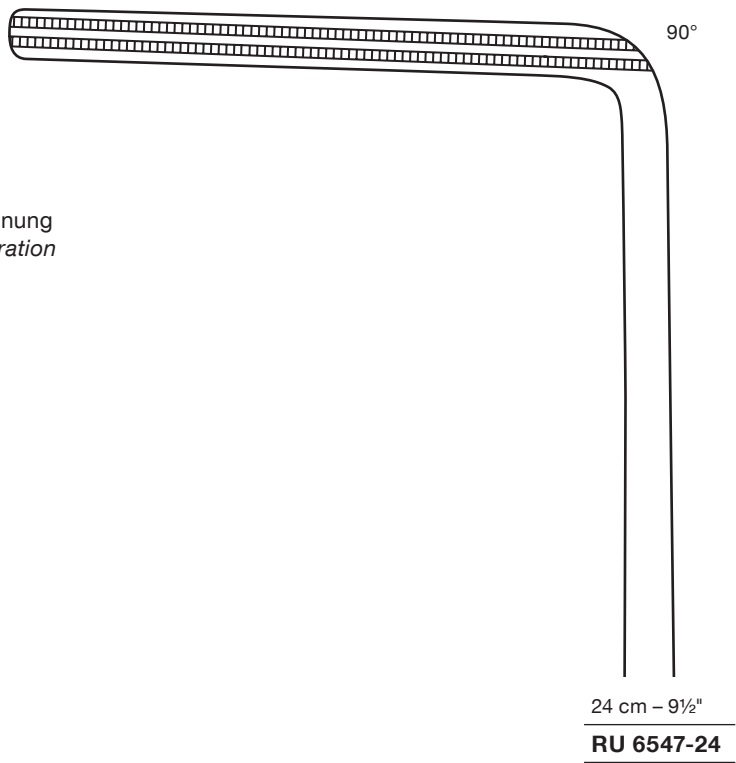

Rektum-Spekula
Rectal Specula



Blattlänge
Length of blade
106 x 23 mm

22 cm – 8¾"
RU 6590-22

CZERNY



Blattlänge
Length of blade
80 x 25 mm

20,5 cm – 8"
RU 6591-20

PRATT



SIMS

Blattlänge
Length of blade
89 x 17 mm

15 cm – 6"
RU 6592-15



gefenstert
fenestrated

15 cm – 6"
RU 6593-15



SIMS

Gesamtlänge Total length	Blattlänge Length of blade	
22 cm – 8¾"	80 x 20 mm	RU 6595-08
	125 x 20 mm	RU 6595-12



MATHIEU

Blattlänge
Length of blade
90 x 15 mm

19,5 cm – 7¾"
RU 6596-19

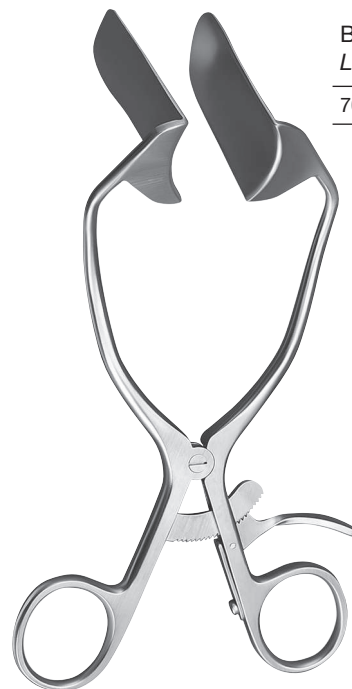

BARR

Blattlänge
Length of blade
70 x 22 mm

17 cm – 6¾"
RU 6597-17



SMITH-BUIE

Analspreizer
Anal retractor

15 cm – 6"

RU 6598-15

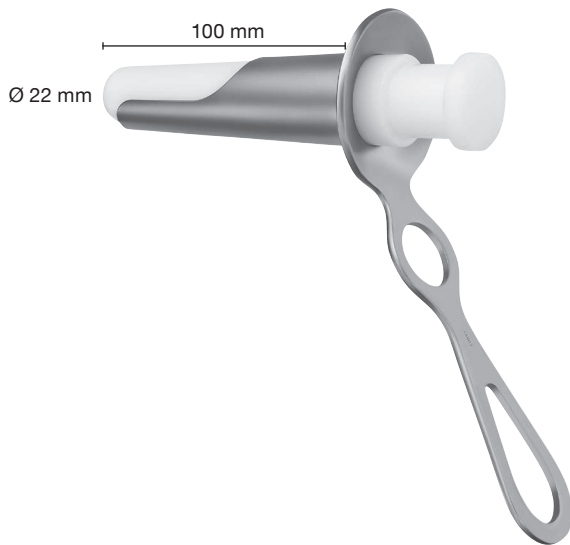

Anoskop
Anoscope

13,5 cm – 5¼"

RU 6604-00

IVES-FANSLER

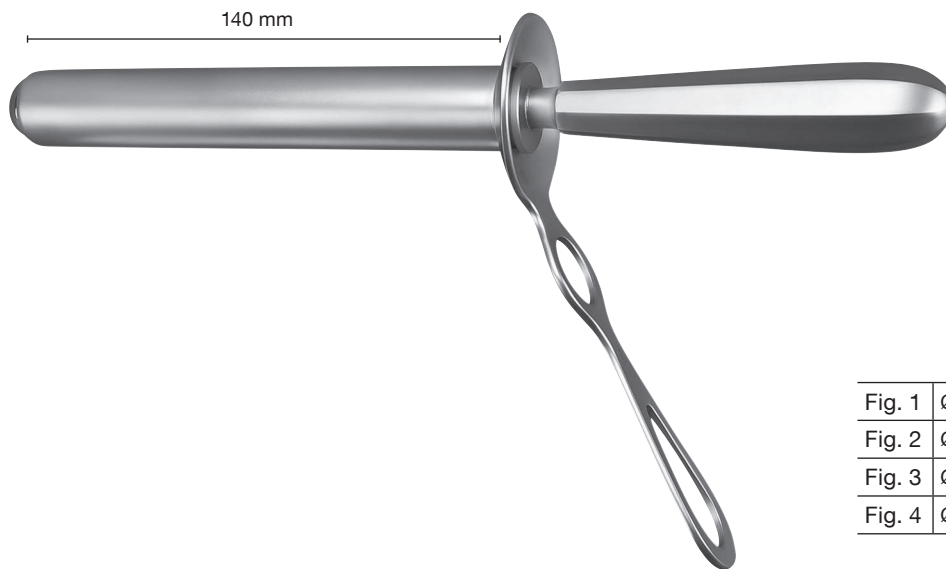

Proktoskope
Proctoscopes

Fig. 1	Ø 22 mm x 50 mm	RU 6605-01
Fig. 2	Ø 22 mm x 100 mm	RU 6605-02
Fig. 3	Ø 22 mm x 140 mm	RU 6605-03
Fig. 4	Ø 22 mm x 200 mm	RU 6605-04

KELLY



Sphinkteroskope
Sphincteroscopes

16 cm – 6¼"

Fig. 1	Ø 21 mm x 50 mm	RU 6606-01
Fig. 2	Ø 25 mm x 50 mm	RU 6606-02

KELLY

Analspreizer Rectal Spreader



Maßangaben für Mittelblätter
und Blätter

1. Zahl = Länge
2. Zahl = Breite

*Dimensions for central blades
and blades*

1st number = length

2nd number = width

Mittelblatt

Beispiel: 95 x 22 mm

Central blade

Example: 95 x 22 mm

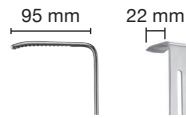

Blätter

Beispiel: 60 x 25 mm

Blades

Example: 60 x 25 mm

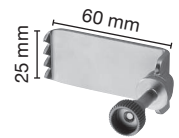

PARK

Sperrer allein <i>Retractor only</i>	RU 6608-01
---	-------------------

Satz komplett, bestehend aus: <i>Set complete, consisting of:</i>	RU 6608-00
--	-------------------

Sperrer allein, 14,5 cm – 5¾" (RU 6608-01)
Retractor only, 14,5 cm – 5¾" (RU 6608-01)

1 Mittelblatt 95 x 22 mm (RU 6608-20)

1 Central blade 95 x 22 mm (RU 6608-20)

1 Paar Blätter seitlich, 70 x 20 mm (RU 6608-27)

1 pair of blades lateral, 70 x 20 mm (6608-27)

1 Paar Blätter seitlich, 90 x 20 mm (RU 6608-29)

1 pair of blades lateral, 90 x 20 mm (6608-29)

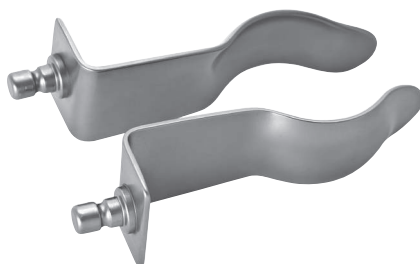

1 Paar
1 pair

70 x 20 mm

RU 6608-27

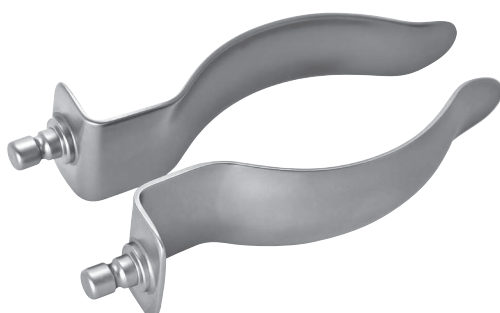

1 Paar
1 pair

90 x 20 mm

RU 6608-29



Mittelblatt
Central blade

95 x 22 mm

RU 6608-20

Rektum-Biopsiefasszangen Rectal Biopsy Forceps

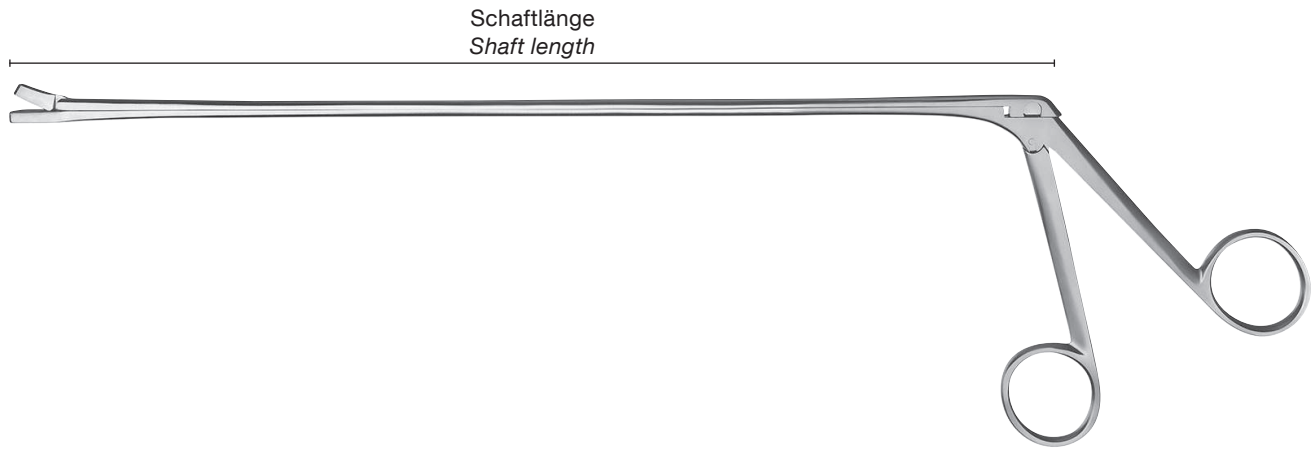

YEOMAN

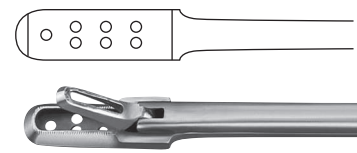
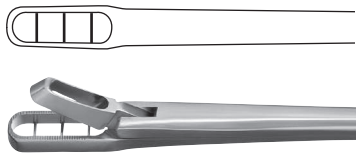

	Bissbreite <i>Bite width</i>	Schaftlänge <i>Shaft length</i>	Fig. 1
	3 mm	28 cm – 11"	RU 6610-28
		35 cm – 13¾"	RU 6610-35
		42 cm – 16½"	RU 6610-42

	Bissbreite <i>Bite width</i>	Schaftlänge <i>Shaft length</i>	Fig. 2
	4 mm	28 cm – 11"	RU 6611-28
		35 cm – 13¾"	RU 6611-35
		42 cm – 16½"	RU 6611-42



PRATT

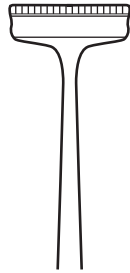

15 cm - 6"

RU 3150-15



FERGUSSON



gerade
straight

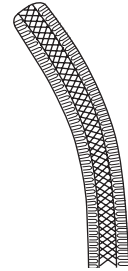

gebogen
curved

16 cm - 6¼"

RU 3390-16

RU 3391-16



HEYWOOD-SMITH

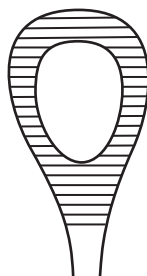

gerade
straight

21 cm - 8¼"

RU 6616-20



HEYWOOD-SMITH

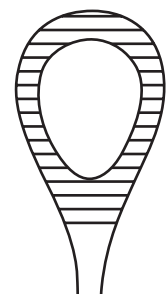

gerade
straight

21 cm - 8¼"

RU 6617-21

Hämorrhoidalzangen Haemorrhoidal Forceps



MC GIVNEY

19 cm – 7½"
RU 6622-19

Hämorrhoidal-Ligatoren Haemorrhoidal Ligators



Hämorrhoidal-Ligator komplett, bestehend aus:
Haemorrhoidal ligator complete, consisting of:

RU 6620-00

- 1 Hämorrhoidal-Ligator (RU 6620-01)
1 Haemorrhoidal ligator (RU 6620-01)
- 1 Ladekonus Ø 10 mm (RU 6620-10)
1 Charging cone Ø 10 mm (RU 6620-10)
- 1 Saugkopf 11 mm x Ø 10 mm (RU 6620-11)
1 Aspiration tip 11 mm x Ø 10 mm (RU 6620-11)
- 1 Saugkopf 16 mm x Ø 10 mm (RU 6620-16)
1 Aspiration tip 16 mm x Ø 10 mm (RU 6620-16)
- 1 Ligatur-Gummiringe (100 Stück) (RU 6620-51)
1 Ligature rubber rings (100 pieces) (RU 6620-51)



Ladekonus
Charging cone

RU 6620-10

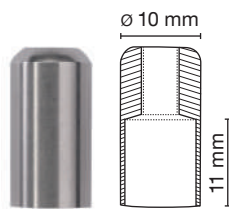

Saugkopf
Aspiration tip

RU 6620-11

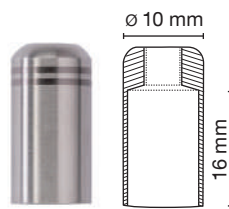

Saugkopf
Aspiration tip

RU 6620-16



Ligatur-Gummiringe, **latexfrei**,
Verpackungseinheit 100 Stück
Ligature rubber rings, latex free,
packing unit 100 pieces

RU 6620-51

Hämorrhoidal-Ligatoren Haemorrhoidal Ligators



Ladekonus
Charging cone

RU 6621-12

Hämorrhoidal-Ligator komplett, bestehend aus:
Haemorrhoidal ligator complete, consisting of:

RU 6621-00

1 x Hämorrhoidal-Ligator, 31,5 cm – 12½" (RU 6621-01)
1 *Haemorrhoidal ligator*, 31,5 cm – 12½" (RU 6621-01)

1 x Ladekonus Ø 12 mm (RU 6621-12)
1 x *Charging cone* Ø 12 mm (RU 6621-12)

1 x Ligatur-Gummiringe (100 Stück) (RU 6620-51)
1 x *Ligature rubber rings* (100 pieces) (RU 6620-51)



Ligatur-Gummiringe, **latexfrei**,
Verpackungseinheit 100 Stück

Ligature rubber rings, latex free,
packing unit 100 pieces

RU 6620-51

Hämorrhoidal-Ligator komplett, bestehend aus:
Haemorrhoidal ligator complete, consisting of:

RU 6622-00

1 x Hämorrhoidal-Ligator
1 x *Haemorrhoidal ligator*

1 x Ladekonus Ø 13 mm (RU 6622-21)
1 x *Charging cone* Ø 13 mm (RU 6622-21)

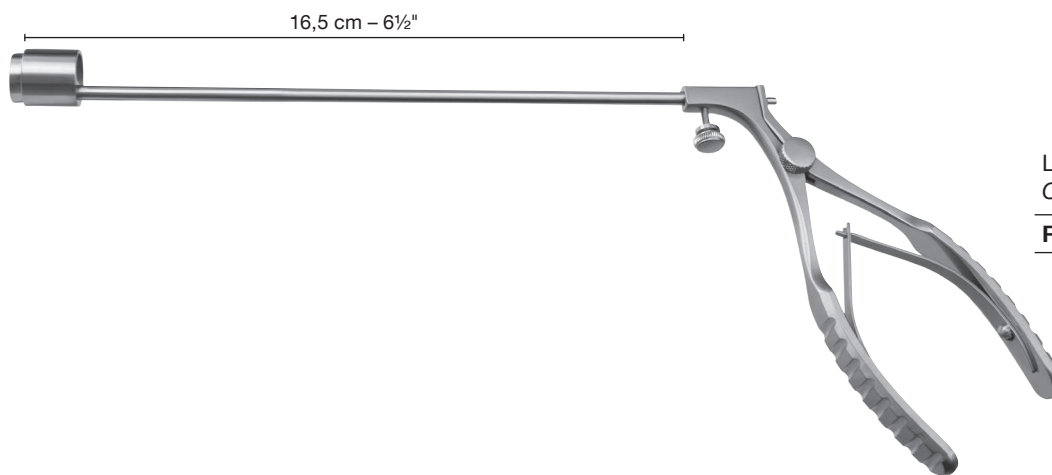

Ladekonus, Ø 13 mm
Charging cone, Ø 13 mm

RU 6622-21

MC GIVNEY

Hämorrhoidal-Ligatoren Haemorrhoidal Ligators



Hämorrhoidal-Ligator komplett, bestehend aus:
Haemorrhoidal ligator complete, consisting of: **RU 6622-05**

1 x Hämorrhoidal-Ligator
1 x Haemorrhoidal ligator

1 x Ladekonus Ø 13 mm (RU 6622-21)
1 x Charging cone Ø 13 mm (RU 6622-21)

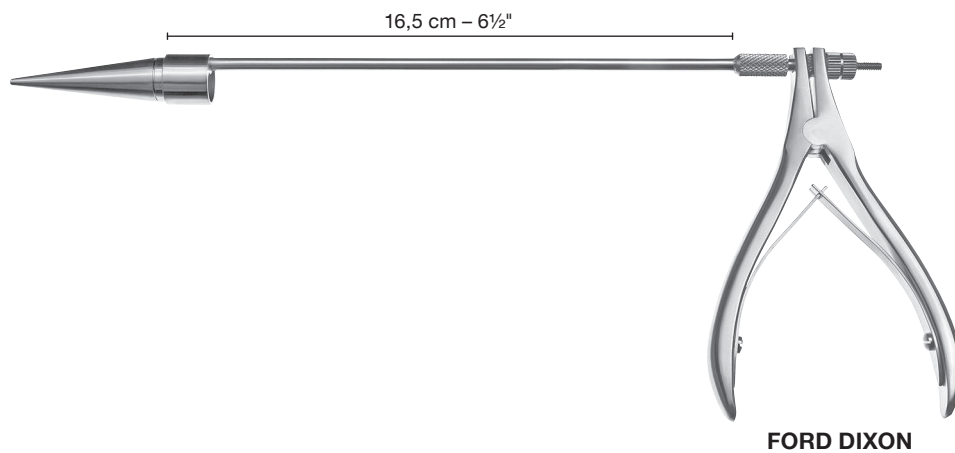

Ladekonus, Ø 13 mm
Charging cone, Ø 13 mm

RU 6622-21



Ligatur-Gummiringe, **latexfrei**,
Verpackungseinheit 100 Stück

Ligature rubber rings, latex free,
packing unit 100 pieces

RU 6620-51

Gallenkanal-Klemmzangen Gall Duct Forceps



GRAY

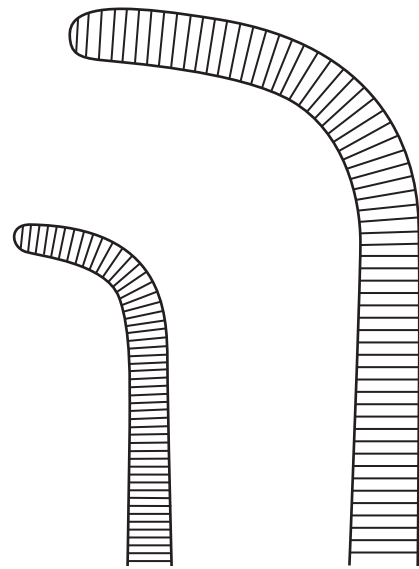
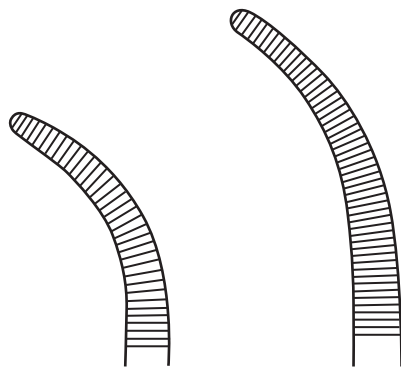

Fig. 1	Fig. 2
22 cm – 8¾"	23 cm – 9"
RU 6642-01	RU 6642-02

Satz à Fig. 1 und Fig. 2
Set of fig. 1 and fig. 2

RU 6642-00



23 cm – 9"	24 cm – 9½"
RU 3401-23	RU 3401-24

Gallenkanal-Klemmzangen
Gall Duct Forceps

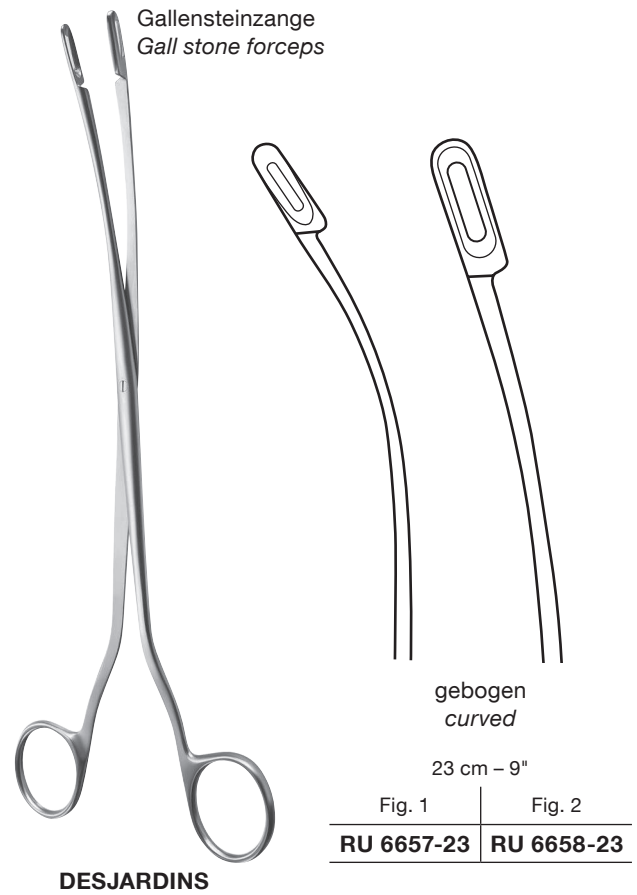
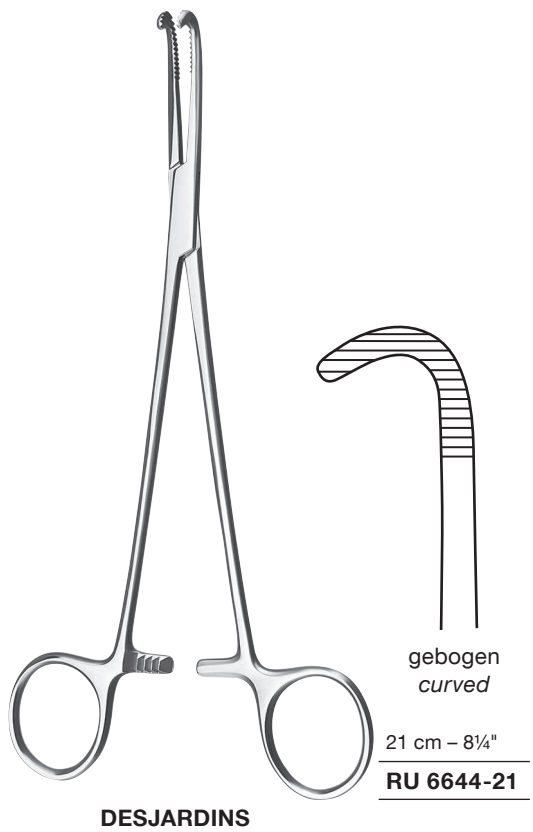



BAKES

Gallengangdilatoren,
biegsam
*Gall duct dilators,
malleable*

mm	30 cm – 11 $\frac{3}{4}$ "
1	RU 6665-01
2	RU 6665-02
3	RU 6665-03
4	RU 6665-04
5	RU 6665-05
6	RU 6665-06
7	RU 6665-07
8	RU 6665-08
9	RU 6665-09
10	RU 6665-10
11	RU 6665-11
12	RU 6665-12
13	RU 6665-13

Satz à 9 Stück
RU 6665-03 – RU 6665-11
*Set of 9 pieces
RU 6665-03 – RU 6665-11*

RU 6665-00

Satz à 9 Stück
RU 6665-03 – RU 6665-11
in Leinentuchtasche
*Set of 9 pieces
RU 6665-03 – RU 6665-11
in canvas pocket*

RU 6665-50

Leinentuchtasche, allein
Canvas pocket, only

RU 6665-71



DESJARDINS

30 cm – 12"

federnd
elastic



Fig. 1

RU 6670-01



Fig. 2

RU 6670-02



Fig. 3

RU 6670-03



Fig. 4

RU 6670-04

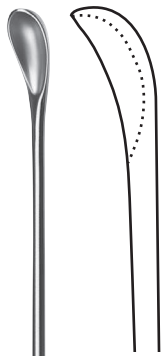

biegsam
malleable



2,5 mm

RU 6675-02



3,2 mm

RU 6675-03



4,2 mm

RU 6675-04



5,5 mm

RU 6675-05



6,7 mm

RU 6675-06



8 mm

RU 6675-08



11 mm

RU 6675-11



15 mm

RU 6675-15

LUER-KOERTE

32 cm – 12½"

Nierenklemmen Kidney Clamps

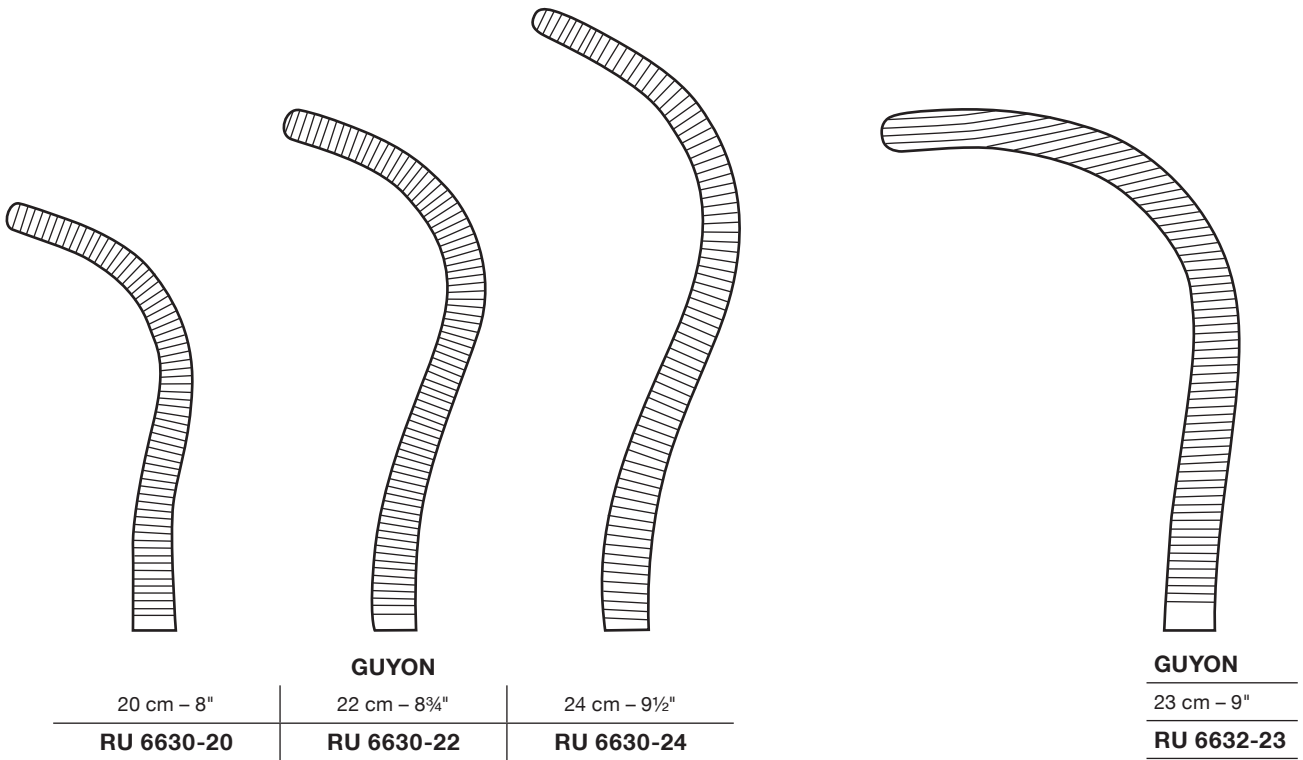

DE BAKEY Zahnung
DE BAKEY Serration

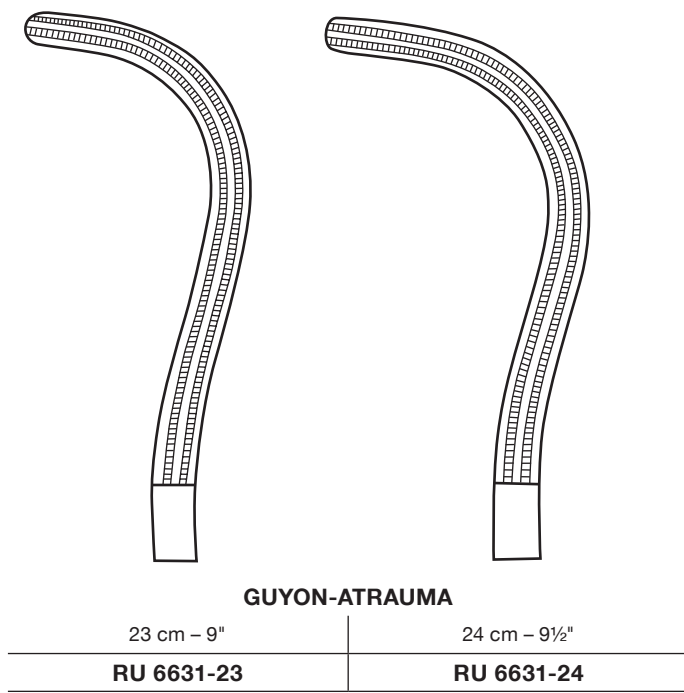

GUYON-ATRAUMA

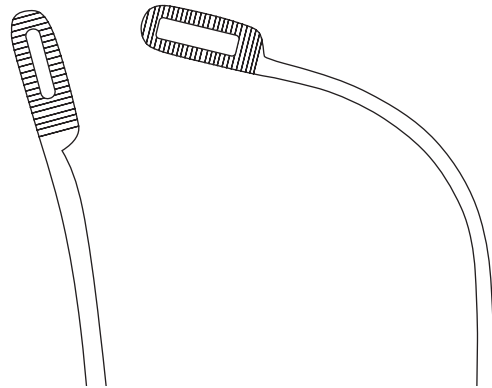

gebogen
curved

Fig. 1

24 cm – 9½"

RU 6640-01

Fig. 2

21 cm – 8¼"

RU 6640-02



RANDALL

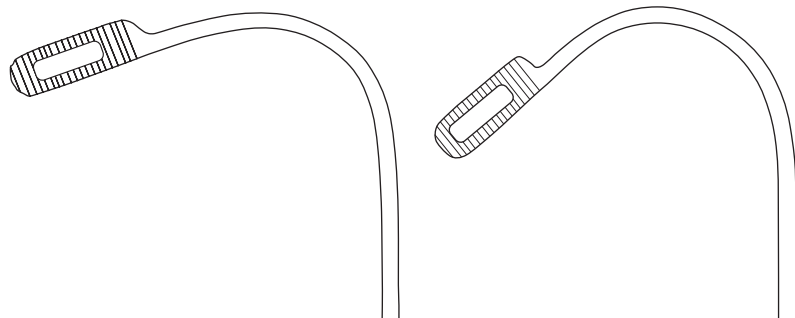

gebogen
curved

Fig. 3

20 cm – 8"

RU 6640-03

Fig. 4

20 cm – 8"

RU 6640-04

Blasenwundspreizer Bladder Retractors



Maßangaben für Mittelblätter
und Blätter

1. Zahl = Länge
2. Zahl = Breite

*Dimensions for central blades
and blades*

1st number = length

2nd number = width

Mittelblatt

Beispiel: 95 x 22 mm

Central blade

Example: 95 x 22 mm

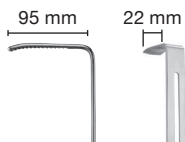

Blätter

Beispiel: 60 x 25 mm

Blades

Example: 60 x 25 mm

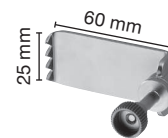

MILLIN

Blasenwundspreizer komplett, bestehend aus:
Bladder retractor complete, consisting of:

RU 6702-00

Sperrer allein

Retractor only

1 Paar Blätter 57 x 25 mm

1 pair of blades 57 x 25 mm

1 Paar Blätter 80 x 25 mm (max. Spreizweite 120 mm)

1 pair of blades, 80 x 25 mm (max. spread 120 mm)

1 Mittelblatt, 110 x 45 mm

1 Central blade, 110 x 45 mm

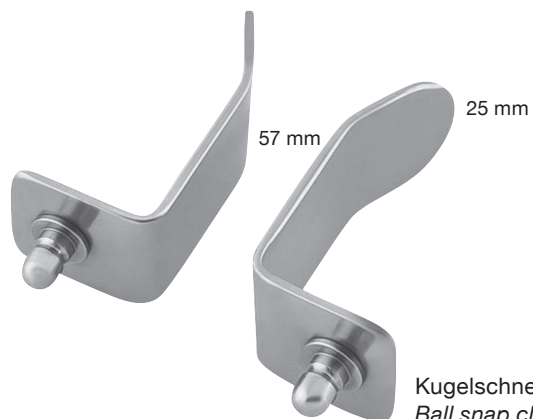

Kugelschnellverschluss
Ball snap closure

Blasenwundspreizer Bladder Retractors



Maßangaben für Mittelblätter
und Blätter

1. Zahl = Länge
2. Zahl = Breite

*Dimensions for central blades
and blades*

1st number = length

2nd number = width

Mittelblatt

Beispiel: 95 x 22 mm

Central blade

Example: 95 x 22 mm

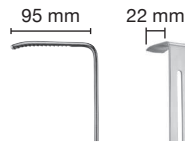

Blätter

Beispiel: 60 x 25 mm

Blades

Example: 60 x 25 mm

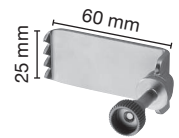

LEGUEU

Blasenwundspreizer komplett, bestehend aus:
Bladder retractor complete, consisting of:

RU 6703-00

Sperrer allein
Retractor only

1 Paar Blätter 62 x 30 mm (max. Spreizweite 70 mm)
1 pair of blades 62 x 30 mm (max. spread 70 mm)

1 Mittelblatt, 85 x 31 mm
1 Central blade, 85 x 31 mm

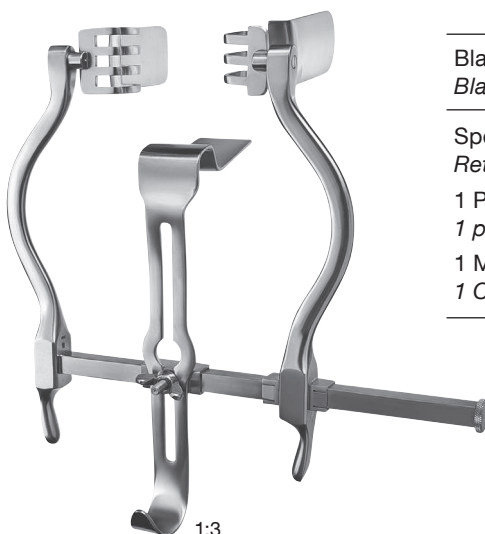

JUDD-MASSON

Blasenwundspreizer komplett, bestehend aus:
Bladder retractor complete, consisting of:

RU 6706-00

Sperrer allein
Retractor only

1 Paar Blätter 67 x 25 mm (max. Spreizweite 120 mm)
1 pair of blades 67 x 25 mm (max. spread 120 mm)

1 Mittelblatt, 75 x 25 mm
1 Central blade, 75 x 25 mm



12 mm

21 cm – 8¼"
RU 6690-21

YOUNG



38 mm

22 cm – 8¾"
RU 6691-22

YOUNG

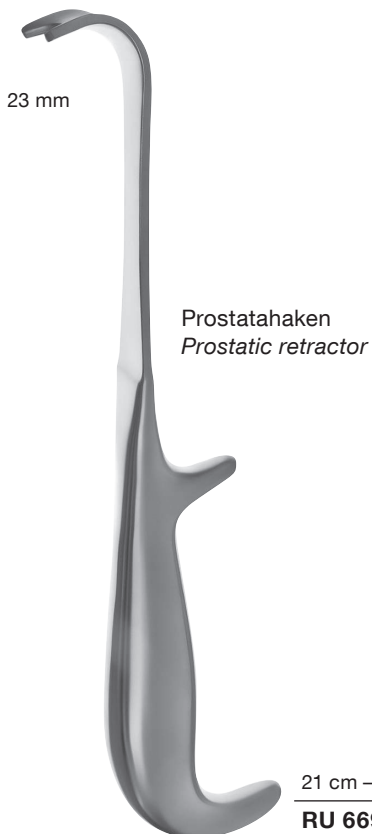

23 mm

Prostatahaken
Prostatic retractor

21 cm – 8¼"
RU 6692-22

YOUNG

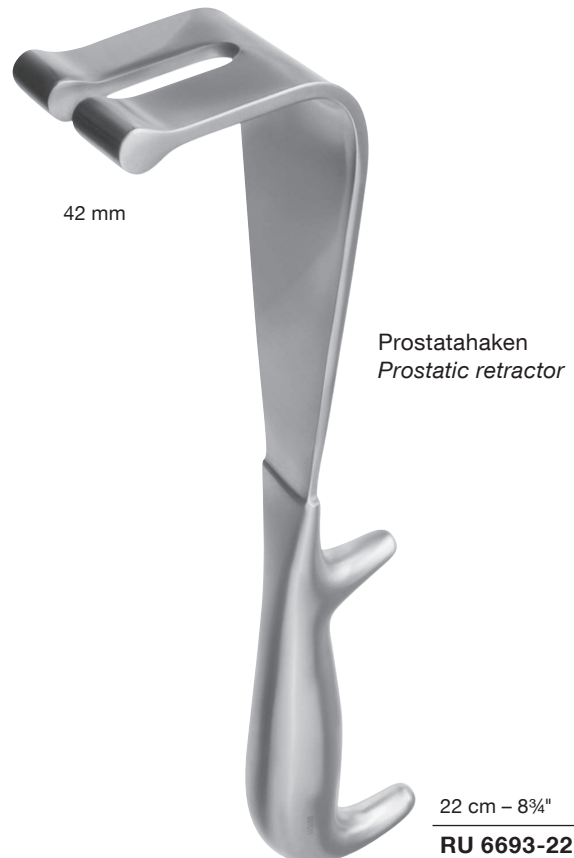

42 mm

Prostatahaken
Prostatic retractor

22 cm – 8¾"
RU 6693-22

YOUNG

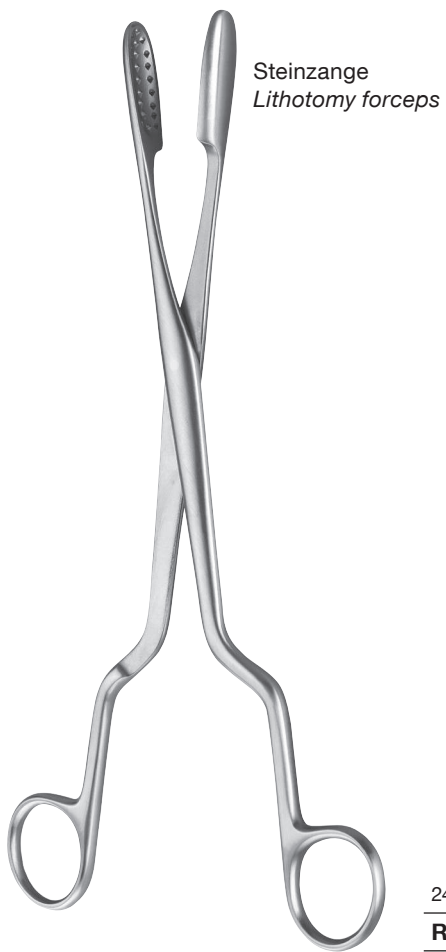

LEWKOWITZ



LEWKOWITZ

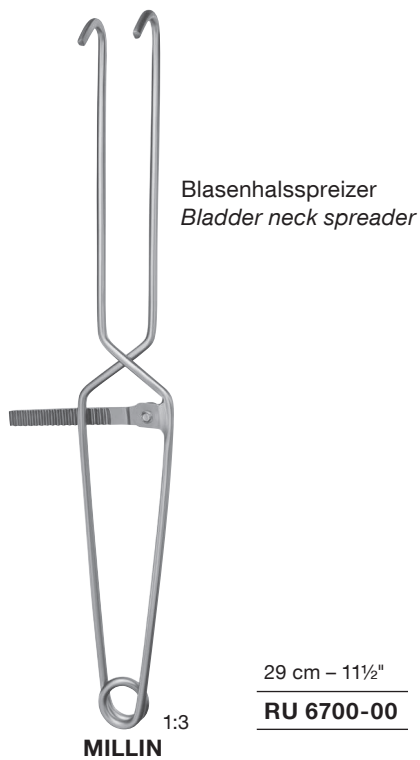



1:3

VAN BURREN

Urethrale Bougies, gebogen
Urethral bougies, curved

Fr. / Charr.	Ø mm	Bèniqùè	27 cm – 10½"
8	2¾	-	RU 6710-08
10	3¾	20	RU 6710-10
12	4	24	RU 6710-12
14	4¾	28	RU 6710-14
16	5¾	32	RU 6710-16
18	6	36	RU 6710-18
20	6¾	40	RU 6710-20
22	7¾	44	RU 6710-22
24	8	48	RU 6710-24
26	8¾	52	RU 6710-26
28	9¾	56	RU 6710-28
30	10	60	RU 6710-30
32	10¾	-	RU 6710-32
34	10¾	-	RU 6710-34
36	12	-	RU 6710-36



1:3

Metallkatheter für Männer,
gebogen
*Metal catheters for men,
curved*

Fr. / Charr.	Ø mm	29 cm – 11½"
8	2¾	RU 6715-08
10	3¾	RU 6715-10
12	4	RU 6715-12
14	4¾	RU 6715-14



Metallkatheter für Frauen,
gebogen
*Metal catheters for women,
curved*

Fr. / Charr.	Ø mm	16 cm – 6¼"
8	3¼	RU 6716-08
10	3¾	RU 6716-10
12	4	RU 6716-12
14	4¾	RU 6716-14
16	5¾	RU 6716-16
18	6	RU 6716-18

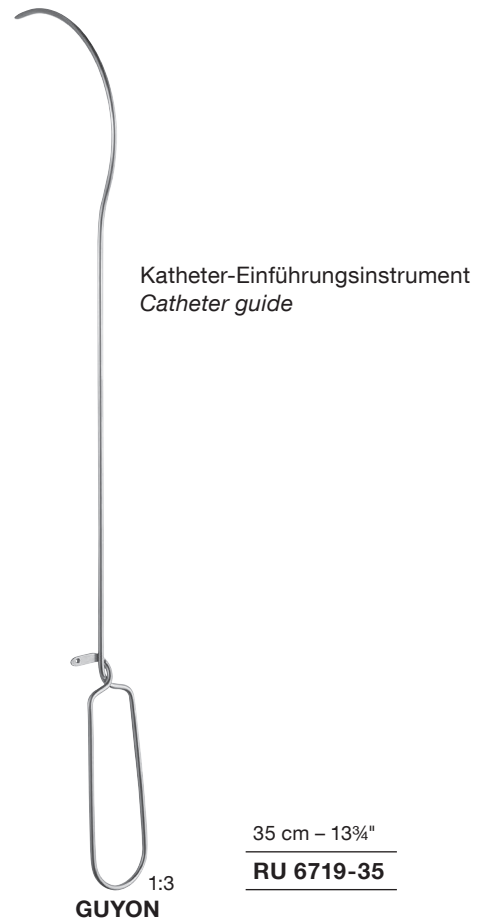
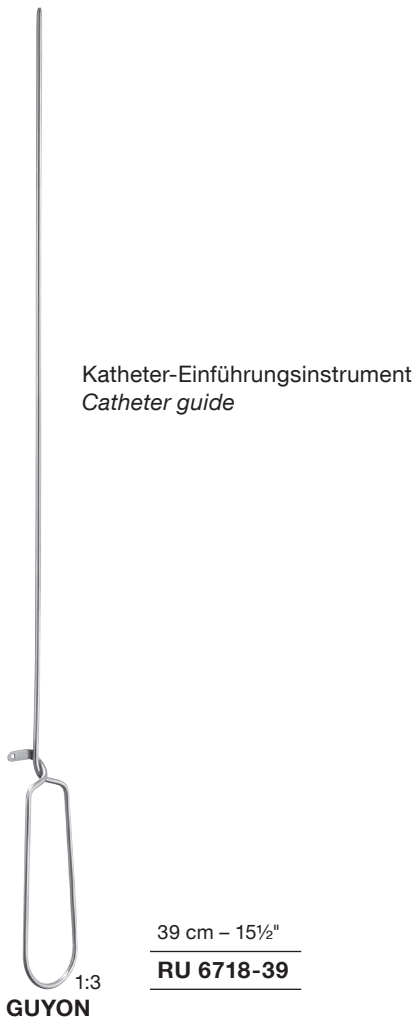

Beschneidungsinstrument
Circumcision instrument

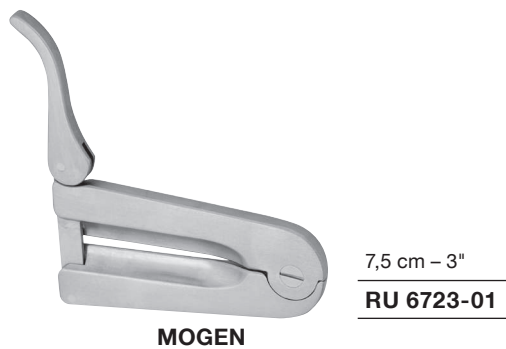

Beschneidungsinstrument
Circumcision instrument

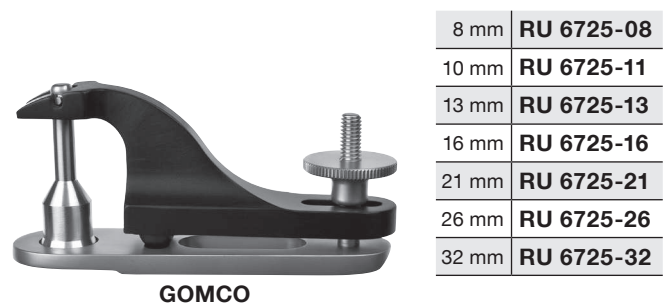

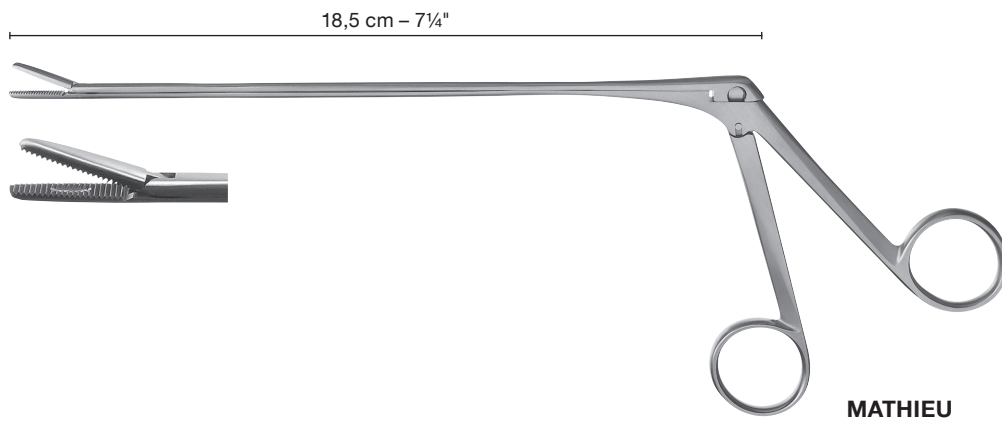

Fremdkörperzange
Foreign body forceps

RU 6727-20

MATHIEU

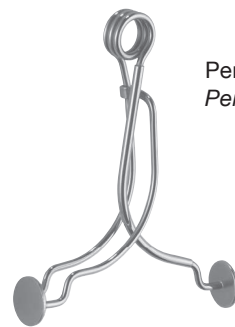

Penisklemme
Penis clamp

7 cm - 2 3/4"

RU 6730-00

STOCKMANN



Sekretlöffel, biegsam
Secretion spoon, malleable

26,5 cm - 10 1/2"

RU 6735-26

GUTTMANN



Penisklemme
Penis clamp

13 cm - 5"

RU 6732-00

STRAUSS





Scheidenspekula	<i>Vaginal Specula</i>	GO 1 - 18, 20 - 21
Scheidenhalter	<i>Vaginal Retractors</i>	GO 19
Uterusdilatoren	<i>Uterine Dilators</i>	GO 22
Endospekula für Cervix	<i>Endospecula for Cervix</i>	GO 23
Uterussonden	<i>Uterine Probes</i>	GO 24
Fasszangen	<i>Grasping Forceps</i>	GO 25
Hakenzangen	<i>Uterine Tenaculum Forceps</i>	GO 26 - 32
Polypen- und Ovarienzangen	<i>Polypus- and Ovary Forceps</i>	GO 33 - 34
Uterusfasszangen	<i>Uterine Elevating Forceps</i>	GO 36 - 37
Biopsieinstrumente	<i>Biopsy Instruments</i>	GO 37, 44
Parametriumklemmen	<i>Parametrium Forceps</i>	GO 38 - 40
Hysterektomieklammern	<i>Hysterectomy Forceps</i>	GO 41 - 42
Vaginalklemmen	<i>Vaginal Forceps</i>	GO 43
Biopsie Küretten	<i>Biopsy Curettes</i>	GO 45
Biopsie Zangen	<i>Biopsy Forceps</i>	GO 46 - 51
Uterus Biopsie Zangen	<i>Uterine Biopsy Forceps</i>	GO 52 - 56
Uteruslöffel	<i>Uterine Scoops</i>	GO 54
Uterusküretten	<i>Uterine Curettes</i>	GO 55 - 57
Biopsie- und Absaugküretten	<i>Biopsy and Aspirating Curettes</i>	GO 58
Salpingograph	<i>Salpingograph</i>	GO 59 - 60
Geburtshilfe	<i>Obstetrics</i>	GO 61 - 62
Geburtszangen	<i>Obstetrical Forceps</i>	GO 63 - 65
Abortuszangen	<i>Ovum Forceps</i>	GO 66
Abortus- und Plazentazangen	<i>Ovum and Placenta Forceps</i>	GO 67
Uterusklemmzangen	<i>Uterine Forceps</i>	GO 68

Scheidenspekula Vaginal Specula



Maßschema für Spekulum
Scheme of dimensions for specula

a	Blattlänge <i>Length of blade</i>
b	Blattbreite <i>Width of blade</i>

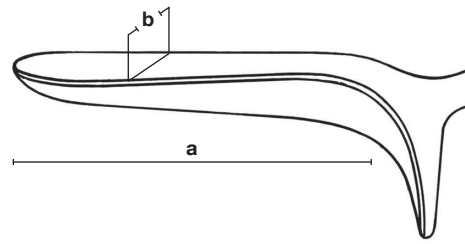

COLLIN

a mm	b mm	für Kinder <i>for children</i>
65	10	RU 7020-10



COLLIN

a mm	b mm	für Jungfrauen <i>for virgins</i>
65	20	RU 7020-11
85	30	RU 7020-01
100	35	RU 7020-02
110	40	RU 7020-03

Scheidenspekula Vaginal Specula



Maßschema für Spekulum
Scheme of dimensions for specula

a	Blattlänge Length of blade
b	Blattbreite Width of blade

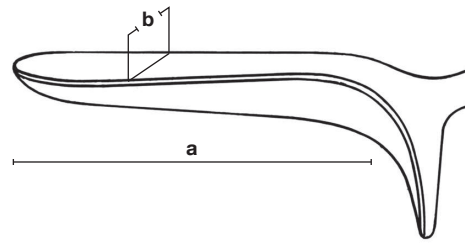

a mm	b mm	für Jungfrauen for virgins
75	17	RU 7002-00

CUSCO



a mm	b mm	für Jungfrauen for virgins
75	17	RU 7003-00

CUSCO

lang und schmal
long and narrow



CUSCO

a mm	b mm	Schweizer Modell Swiss pattern
90	23-25	RU 7004-01
100	25-27	RU 7004-02
110	27-30	RU 7004-03

Scheidenspekula Vaginal Specula



Maßschema für Spekulum
Scheme of dimensions for specula

a	Blattlänge Length of blade
b	Blattbreite Width of blade

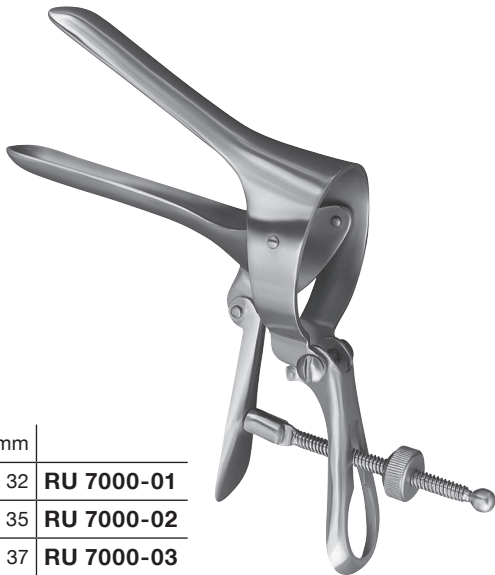
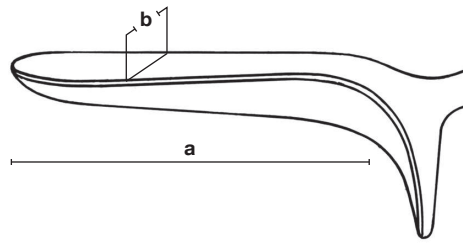

a mm	b mm	
75	32	RU 7000-01
85	35	RU 7000-02
100	37	RU 7000-03

CUSCO

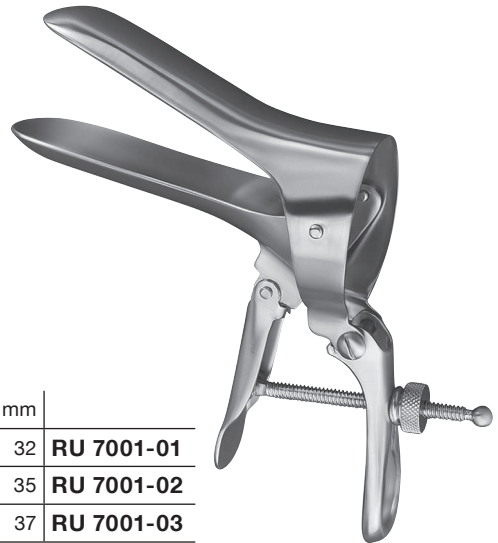

a mm	b mm	
75	32	RU 7001-01
85	35	RU 7001-02
100	37	RU 7001-03

CUSCO

Scheidenspekula Vaginal Specula



Maßschema für Spekulum
Scheme of dimensions for specula

a	Blattlänge Length of blade
b	Blattbreite Width of blade

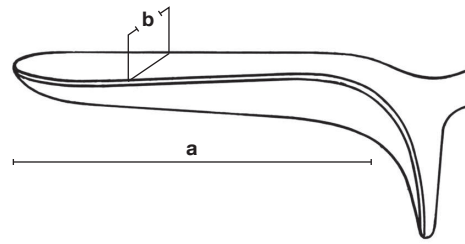

a mm	b mm	
85	33	RU 7022-01
95	35	RU 7022-02
115	43	RU 7022-03

TRÉLAT



a mm	b mm	
101	35	RU 7023-01 abgewinkelt 135° angled 135°

GRAVE



a mm	b mm	rechts offen, abgewinkelt 90° right side open, angled 90°	rechts offen, abgewinkelt 135° right side open, angled 135°
101	35	RU 7023-02	RU 7023-03

GRAVE

Scheidenspekula Vaginal Specula



Maßschema für Spekulum
Scheme of dimensions for specula

a	Blattlänge Length of blade
b	Blattbreite Width of blade

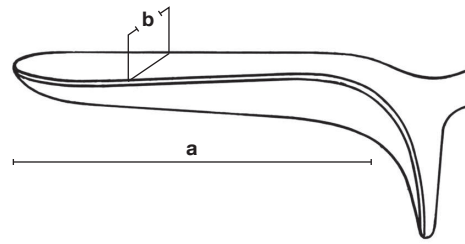

Laser-Spekula
Laser specula



a mm	b mm	
75	20	RU 7024-01
95	30	RU 7024-02
115	35	RU 7024-03

GRAVE



a mm	b mm	
75	20	RU 7025-01
95	30	RU 7025-02
115	35	RU 7025-03
125	35	RU 7025-05

GRAVE

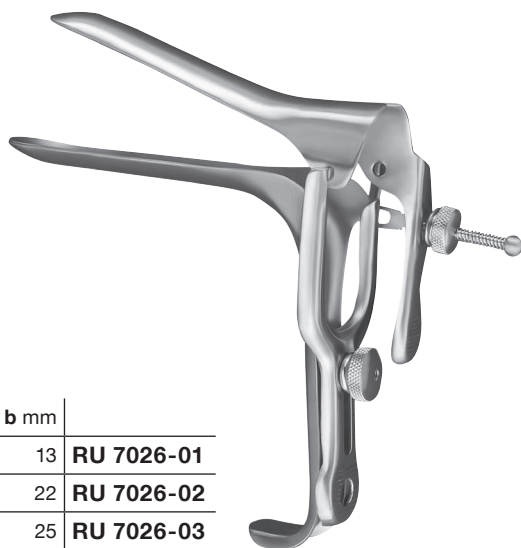

a mm	b mm	
75	13	RU 7026-01
100	22	RU 7026-02
120	25	RU 7026-03

PEDERSON

55 mm
56 x 21 mm

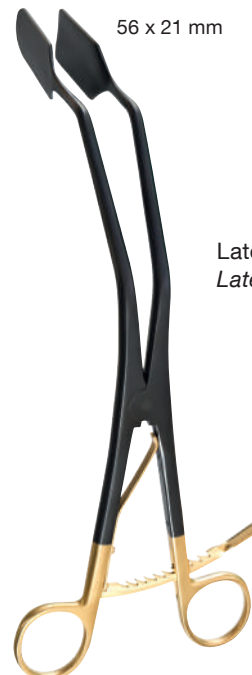

Lateral-Spekulum
Lateral specula

25,5 cm – 10"
RU 7040-00

1:3

Scheidenspekula, Sets Vaginal Specula, Sets



Maßschema für Spekulum
Scheme of dimensions for specula

a	Blattlänge Length of blade
b	Blattbreite Width of blade

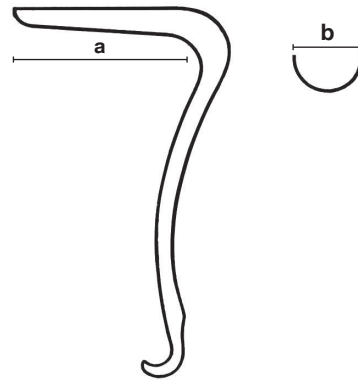

SIMS

a mm	b mm	
53	32	RU 7049-01
58	32	RU 7049-02
70	38	RU 7049-03



SIMS

Fig.	a mm	b mm	
1	60	25 + 30	RU 7050-01
2	70	30 + 35	RU 7050-02
3	80	35 + 40	RU 7050-03

Satz
Set
RU 7050-00

Scheidenspekula, Sets Vaginal Specula, Sets



Maßschema für Spekulum
Scheme of dimensions for specula

a	Blattlänge Length of blade
b	Blattbreite Width of blade

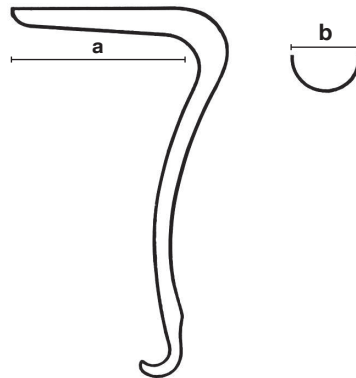

JACKSON

Fig.	a mm	b mm	
1	75	35	RU 7055-01
2	90	35	RU 7055-02
3	100	35	RU 7055-03

Fig.	a mm	b mm	
1	75	38	RU 7056-01
2	90	38	RU 7056-02
3	100	38	RU 7056-03



KALLMORGEN

Scheidenspekulum komplett, bestehend aus: <i>Vaginal specula complete, consisting of:</i>	RU 7078-01
--	-------------------

1 Spekulum Fig. 1, 70 x 40 mm (RU 7078-11) <i>1 Specula fig. 1, 70 x 40 mm (RU 7078-11)</i>
1 Halter Fig. 1, 70 x 33 mm (RU 7078-21) <i>1 Retractor fig. 1, 70 x 33 mm (RU 7078-21)</i>

Scheidenspekulum komplett, bestehend aus: <i>Vaginal specula complete, consisting of:</i>	RU 7078-02
--	-------------------

1 Spekulum Fig. 2, 90 x 40 mm (RU 7078-12) <i>1 Specula fig. 2, 90 x 40 mm (RU 7078-12)</i>
1 Halter Fig. 2, 90 x 33 mm (RU 7078-22) <i>1 Retractor fig. 2, 90 x 33 mm (RU 7078-22)</i>

Fig.	a mm	b mm	Spekulum Specula
1	70	40	RU 7078-11
2	90	40	RU 7078-12

Fig.	a mm	b mm	Halter Retractor
1	70	33	RU 7078-21
2	90	33	RU 7078-22

Scheidenspekula, Sets Vaginal Specula, Sets



Maßschema für Spekulum
Scheme of dimensions for specula

a	Blattlänge Length of blade
b	Blattbreite Width of blade

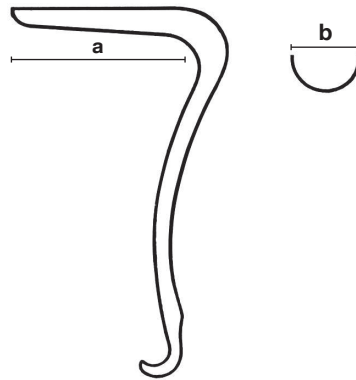

KRISTELLER

Scheidenspekulum für Kinder komplett, bestehend aus: Vaginal specula for children complete, consisting of:	RU 7060-00
---	-------------------

1 Spekulum, 70 x 15 mm (RU 7060-30)
1 Specula, 70 x 15 mm (RU 7060-30)
1 Halter, 75 x 10 mm (RU 7060-40)
1 Retractor, 75 x 10 mm (RU 7060-40)

a mm	b mm	Spekulum Specula
70	15	RU 7060-30

a mm	b mm	Halter Retractor
75	10	RU 7060-40

Scheidenspekula, Sets Vaginal Specula, Sets



Maßschema für Spekulum
Scheme of dimensions for specula

a	Blattlänge Length of blade
b	Blattbreite Width of blade

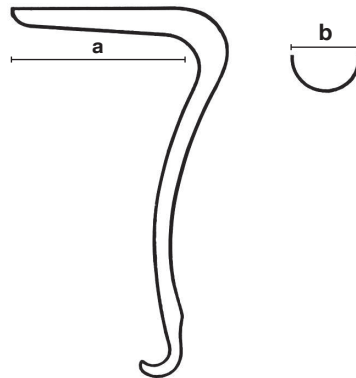

KRISTELLER

Scheidenspekulum komplett, bestehend aus: Vaginal specula complete, consisting of:	RU 7060-01
---	-------------------

1 Spekulum Fig. 1, 70 x 27 mm (RU 7060-11)
1 Specula fig. 1, 70 x 27 mm (RU 7060-11)
1 Halter Fig. 1, 75 x 23 mm (RU 7060-21)
1 Retractor fig. 1, 75 x 23 mm (RU 7060-21)

Scheidenspekulum komplett, bestehend aus: Vaginal specula complete, consisting of:	RU 7060-02
---	-------------------

1 Spekulum Fig. 2, 75 x 30 mm (RU 7060-12)
1 Specula fig. 2, 75 x 30 mm (RU 7060-12)
1 Halter Fig. 2, 80 x 26 mm (RU 7060-22)
1 Retractor fig. 2, 80 x 26 mm (RU 7060-22)

Scheidenspekulum komplett, bestehend aus: Vaginal specula complete, consisting of:	RU 7060-03
---	-------------------

1 Spekulum Fig. 3, 90 x 36 mm (RU 7060-13)
1 Specula fig. 3, 90 x 36 mm (RU 7060-13)
1 Halter Fig. 3, 95 x 32 mm (RU 7060-23)
1 Retractor fig. 3, 95 x 32 mm (RU 7060-23)

Fig.	a mm	b mm	Spekulum Specula	Fig.	a mm	b mm	Halter Retractor
1	70	27	RU 7060-11	1	75	23	RU 7060-21
2	75	30	RU 7060-12	2	80	26	RU 7060-22
3	90	36	RU 7060-13	3	95	32	RU 7060-23

Scheidenspekula, Sets Vaginal Specula, Sets



Maßschema für Spekulum
Scheme of dimensions for specula

a	Blattlänge Length of blade
b	Blattbreite Width of blade

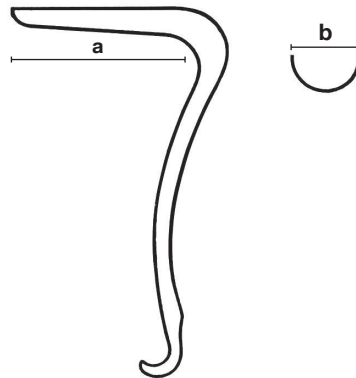

mit konisch verlaufenden
Blättern, für Jungfrauen
with conically shaped
blades, for virgins

KRISTELLER

Scheidenspekulum komplett, bestehend aus: <i>Vaginal specula complete, consisting of:</i>	RU 7065-01
--	-------------------

1 Spekulum Fig. 00, 110 x 18 mm (RU 7065-11) 1 Specula fig. 00, 110 x 18 mm (RU 7065-11)
1 Halter Fig. 00, 115 x 14 mm (RU 7065-21) 1 Retractor fig. 00, 115 x 14 mm (RU 7065-21)

Scheidenspekulum komplett, bestehend aus: <i>Vaginal specula complete, consisting of:</i>	RU 7065-02
--	-------------------

1 Spekulum Fig. 0, 110 x 21 mm (RU 7065-12) 1 Specula fig. 0, 110 x 21 mm (RU 7065-12)
1 Halter Fig. 0, 115 x 17 mm (RU 7065-22) 1 Retractor fig. 0, 115 x 17 mm (RU 7065-22)

Fig.	a mm	b mm	Spekulum Specula	Fig.	a mm	b mm	Halter Retractor
00	110	18	RU 7065-11	00	115	14	RU 7065-21
0	110	21	RU 7065-12	0	115	17	RU 7065-22

Scheidenspekula, Sets Vaginal Specula, Sets



Maßschema für Spekulum
Scheme of dimensions for specula

a	Blattlänge Length of blade
b	Blattbreite Width of blade

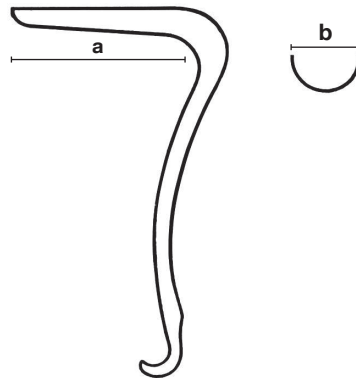

mit besonders
langen Löffeln
with extra
long blades

KRISTELLER

Scheidenspekulum komplett, bestehend aus: Vaginal specula complete, consisting of:	RU 7070-01
---	-------------------

1 Spekulum Fig. 1, 110 x 27 mm (RU 7070-11) 1 Specula fig. 1, 110 x 27 mm (RU 7070-11) 1 Halter Fig. 1, 115 x 23 mm (RU 7070-21) 1 Retractor fig. 1, 115 x 23 mm (RU 7070-21)
--

Scheidenspekulum komplett, bestehend aus: Vaginal specula complete, consisting of:	RU 7070-02
---	-------------------

1 Spekulum Fig. 2, 110 x 30 mm (RU 7070-12) 1 Specula fig. 2, 110 x 30 mm (RU 7070-12) 1 Halter Fig. 2, 115 x 26 mm (RU 7070-22) 1 Retractor fig. 2, 115 x 26 mm (RU 7070-22)
--

Scheidenspekulum komplett, bestehend aus: Vaginal specula complete, consisting of:	RU 7070-03
---	-------------------

1 Spekulum Fig. 3, 110 x 36 mm (RU 7070-13) 1 Specula fig. 3, 110 x 36 mm (RU 7070-13) 1 Halter Fig. 3, 115 x 32 mm (RU 7070-23) 1 Retractor fig. 3, 115 x 32 mm (RU 7070-23)
--

Fig.	a mm	b mm	Spekulum Specula
1	110	27	RU 7070-11
2	110	30	RU 7070-12
3	110	36	RU 7070-13

Fig.	a mm	b mm	Halter Retractor
1	115	23	RU 7070-21
2	115	26	RU 7070-22
3	115	32	RU 7070-23

Scheidenspekula, Sets Vaginal Specula, Sets



Maßschema für Spekulum
Scheme of dimensions for specula

a	Blattlänge Length of blade
b	Blattbreite Width of blade

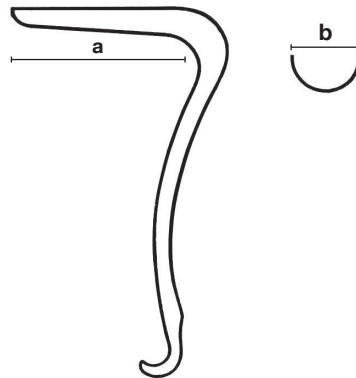

mit abgeflachtem Spekulum
with flattened specula

KRISTELLER

Scheidenspekulum komplett, bestehend aus:
Vaginal specula complete, consisting of: **RU 7072-01**

1 Spekulum Fig. 1, 110 x 27 mm (RU 7072-11)
1 Specula fig. 1, 110 x 27 mm (RU 7072-11)
1 Halter Fig. 1, 115 x 23 mm (RU 7072-21)
1 Retractor fig. 1, 115 x 23 mm (RU 7072-21)

Scheidenspekulum komplett, bestehend aus:
Vaginal specula complete, consisting of: **RU 7072-02**

1 Spekulum Fig. 2, 110 x 30 mm (RU 7072-12)
1 Specula fig. 2, 110 x 30 mm (RU 7072-12)
1 Halter Fig. 2, 115 x 26 mm (RU 7072-22)
1 Retractor fig. 2, 115 x 26 mm (RU 7072-22)

Scheidenspekulum komplett, bestehend aus:
Vaginal specula complete, consisting of: **RU 7072-03**

1 Spekulum Fig. 3, 110 x 36 mm (RU 7072-13)
1 Specula fig. 3, 110 x 36 mm (RU 7072-13)
1 Halter Fig. 3, 115 x 32 mm (RU 7072-23)
1 Retractor fig. 3, 115 x 32 mm (RU 7072-23)

Fig.	a mm	b mm	Spekulum Specula
1	110	27	RU 7072-11
2	110	30	RU 7072-12
3	110	36	RU 7072-13

Fig.	a mm	b mm	Halter Retractor
1	115	23	RU 7072-21
2	115	26	RU 7072-22
3	115	32	RU 7072-23

Scheidenspekula Vaginal Specula



Maßschema für Spekulum
Scheme of dimensions for specula

a	Blattlänge Length of blade
b	Blattbreite Width of blade

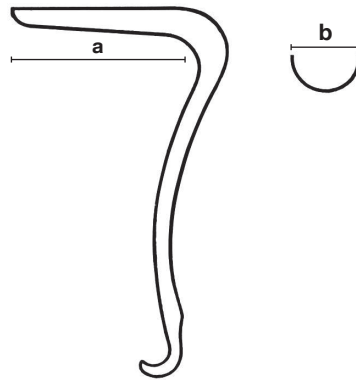

MATZENAUER

a mm	b mm	
100	20	RU 7073-01
100	25	RU 7073-02
100	30	RU 7073-03
100	35	RU 7073-04
100	40	RU 7073-05

a mm	b mm	
130	20	RU 7073-11
130	25	RU 7073-12
130	30	RU 7073-13
130	35	RU 7073-14
130	40	RU 7073-15

Scheidenspekula Vaginal Specula



Maßschema für Spekulum
Scheme of dimensions for specula

a	Blattlänge Length of blade
b	Blattbreite Width of blade

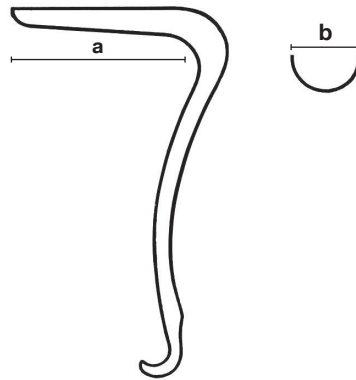

BRAUN

a mm	b mm	18 cm – 7"
56	13	RU 7074-00



BRAUN

a mm	b mm	18 cm – 7"
60	10	RU 7075-00

Scheidenspekula Vaginal Specula



Maßschema für Spekulum
Scheme of dimensions for specula

a	Blattlänge Length of blade
b	Blattbreite Width of blade

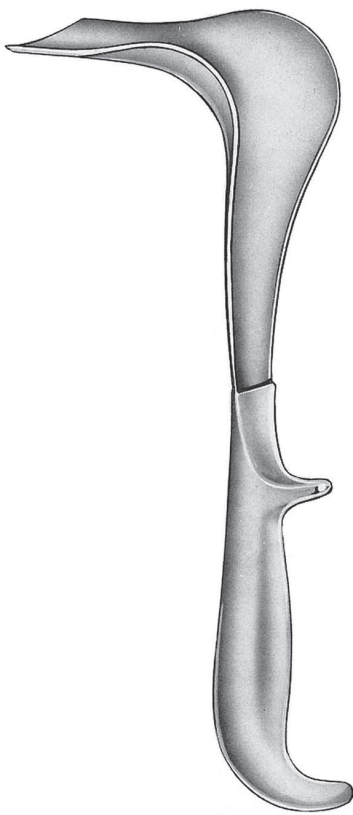
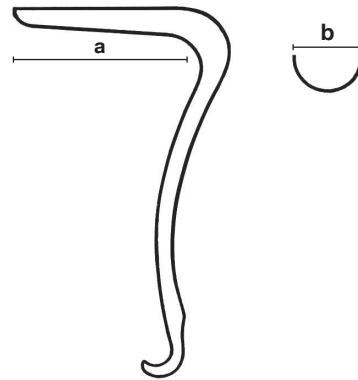

DOYEN

Fig.	a mm	b mm	
1	75	45	RU 7080-11
2	90	45	RU 7080-12
3	110	45	RU 7080-13

Scheidenspekula Vaginal Specula



Maßschema für Spekulum
Scheme of dimensions for specula

a	Blattlänge Length of blade
b	Blattbreite Width of blade

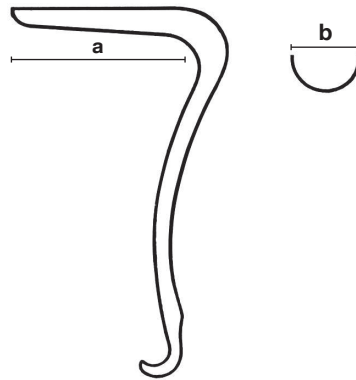

DOYEN

24 cm – 9½"

Fig.	a mm	b mm	leicht hohl slightly-concave
1	55	35	RU 7080-01
2	85	35	RU 7080-02
3	115	35	RU 7080-03
1	55	45	RU 7081-01
2	85	45	RU 7081-02
3	115	45	RU 7081-03
4	160	45	RU 7081-04
1	55	60	RU 7082-01
2	85	60	RU 7082-02
3	115	60	RU 7082-03
4	160	60	RU 7082-04

Scheidenspekula Vaginal Specula



Maßschema für Spekulum
Scheme of dimensions for specula

a	Blattlänge <i>Length of blade</i>
b	Blattbreite <i>Width of blade</i>

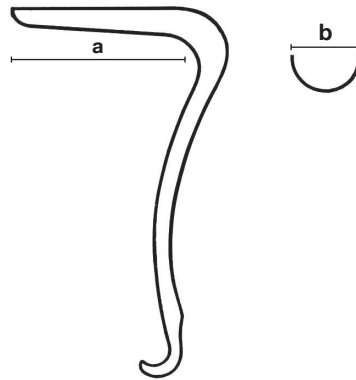

DOYEN

24 cm – 9½"

Fig.	a mm	b mm	halbhohl <i>medium-concave</i>
1	55	35	RU 7083-01
2	85	35	RU 7083-02
3	115	35	RU 7083-03
1	55	45	RU 7084-01
2	85	45	RU 7084-02
3	115	45	RU 7084-03
1	55	60	RU 7085-01
2	85	60	RU 7085-02
3	115	60	RU 7085-03

Scheidenspekula Vaginal Specula



Maßschema für Spekulum
Scheme of dimensions for specula

a	Blattlänge Length of blade
b	Blattbreite Width of blade

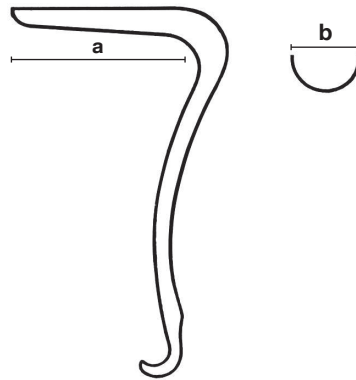

BREISKY

a mm	b mm	
100	20	RU 7090-20
100	25	RU 7090-25
100	30	RU 7090-30
100	35	RU 7090-35
100	40	RU 7090-40
<hr/>		
130	20	RU 7091-20
130	25	RU 7091-25
130	30	RU 7091-30
130	35	RU 7091-35
130	40	RU 7091-40
<hr/>		
160	20	RU 7092-20
160	25	RU 7092-25
160	30	RU 7092-30
160	35	RU 7092-35
160	40	RU 7092-40
<hr/>		
180	20	RU 7093-20
180	25	RU 7093-25
180	30	RU 7093-30
180	35	RU 7093-35
180	40	RU 7093-40

Scheidenhalter Vaginal Retractors



Maßschema für Spekulum
Scheme of dimensions for specula

a	Blattlänge Length of blade
b	Blattbreite Width of blade

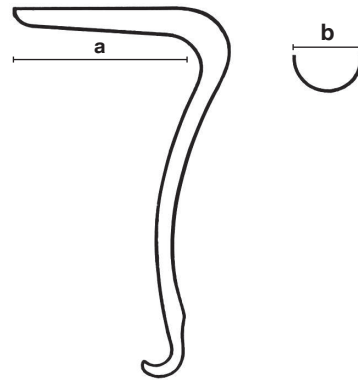

seitliches Spekulum
lateral speculum

DOYEN

a mm	b mm	25 cm – 10"
60	30	RU 7086-01
70	30	RU 7086-02
80	30	RU 7086-25

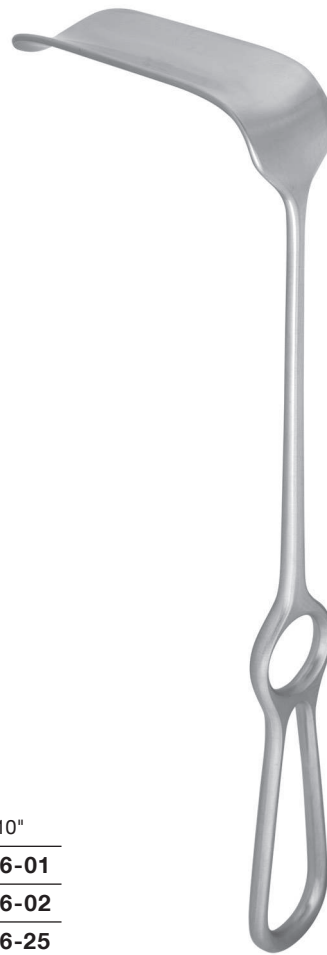

HÖSEL

	25 cm – 10"
60 x 20 mm	RU 4542-01
80 x 30 mm	RU 4542-02
100 x 30 mm	RU 4542-03
120 x 30 mm	RU 4542-04
140 x 30 mm	RU 4542-05
140 x 40 mm	RU 4542-06

Scheidenspekula Vaginal Specula



Maßschema für Spekulum
Scheme of dimensions for specula

a	Blattlänge Length of blade
b	Blattbreite Width of blade

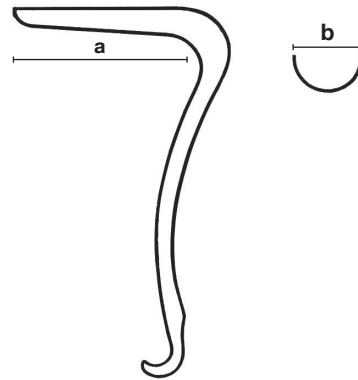

mit abnehmbarem Gewicht
with detachable weight

a mm	b mm	
80	38	RU 7088-00
105	42	RU 7088-10

AUVARD

1:3



mit festem Gewicht
with fixed weight

a mm	b mm	
70	38	RU 7088-51
102	45	RU 7088-52

AUVARD

1:3

Scheidenspekula Vaginal Specula



Maßschema für Spekulum
Scheme of dimensions for specula

a	Blattlänge Length of blade
b	Blattbreite Width of blade

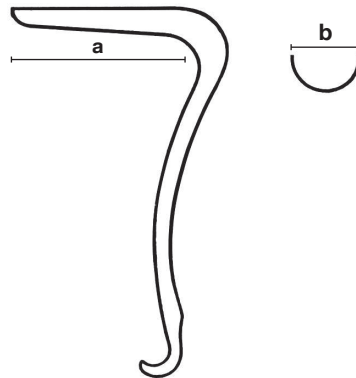

Scheidenspekulum komplett, bestehend aus:
Vaginal specula complete, consisting of: **RU 7095-00**

- 1 Griff (RU 7095-14)
- 1 Handle (RU 7095-14)
- 1 Gewicht, leicht, 400 g (RU 7095-10)
- 1 Weight, light, 400 g (RU 7095-10)
- 5 Blätter (1 Stück) (RU 7095-01, -02, -03, -04, -05)
- 5 Blades (1 piece) (RU 7095-01, -02, -03, -04, -05)



SCHERBAK



Griff
Handle
RU 7095-14

Gewicht, leicht, 400 g
Weight, light, 400 g
RU 7095-10

Gewicht, schwer, 800 g
Weight, heavy, 800 g
RU 7095-12



Uterusdilatoren Uterine Dilators



HEGAR

Ø mm	
1	RU 7100-01
2	RU 7100-02
3	RU 7100-03
4	RU 7100-04
5	RU 7100-05
6	RU 7100-06
7	RU 7100-07
8	RU 7100-08
9	RU 7100-09
10	RU 7100-10
11	RU 7100-11
12	RU 7100-12
13	RU 7100-13
14	RU 7100-14
15	RU 7100-15

Ø mm	
16	RU 7100-16
17	RU 7100-17
18	RU 7100-18
19	RU 7100-19
20	RU 7100-20
21	RU 7100-21
22	RU 7100-22
23	RU 7100-23
24	RU 7100-24
25	RU 7100-25
26	RU 7100-26
27	RU 7100-27
28	RU 7100-28
29	RU 7100-29
30	RU 7100-30

Ø mm	
1,5	RU 7101-01
2,5	RU 7101-02
3,5	RU 7101-03
4,5	RU 7101-04
5,5	RU 7101-05
6,5	RU 7101-06
7,5	RU 7101-07
8,5	RU 7101-08
9,5	RU 7101-09
10,5	RU 7101-10
11,5	RU 7101-11
12,5	RU 7101-12
13,5	RU 7101-13
14,5	RU 7101-14
15,5	RU 7101-15
16,5	RU 7101-16
17,5	RU 7101-17
18,5	RU 7101-18
19,5	RU 7101-19



HEGAR

Ø mm	
1 / 2	RU 7102-02
3 / 4	RU 7102-04
5 / 6	RU 7102-06
7 / 8	RU 7102-08
9 / 10	RU 7102-10
11 / 12	RU 7102-12
13 / 14	RU 7102-14
15 / 16	RU 7102-16
17 / 18	RU 7102-18
19 / 20	RU 7102-20
21 / 22	RU 7102-22
23 / 24	RU 7102-24
25 / 26	RU 7102-26

Stück per Satz <i>Pieces per set</i>	Satz <i>Set</i>
8 St. / pcs. (3 / 4 – 17 / 18 mm)	RU 7102-30
13 St. / pcs. (1 / 2 – 25 / 26 mm)	RU 7102-40



34 cm – 13½"
RU 7120-34

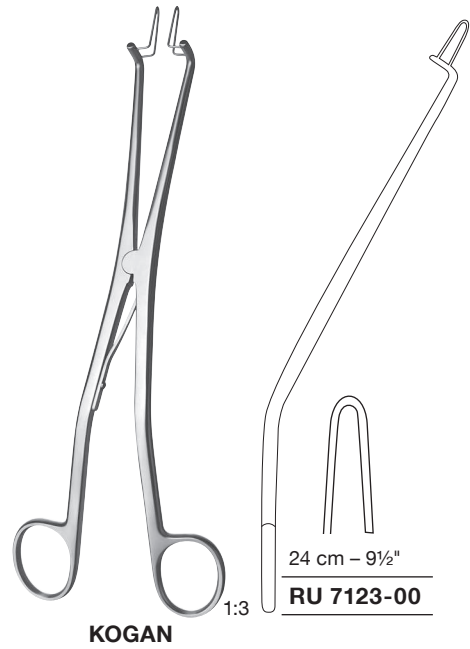

24 cm – 9½"
RU 7123-00

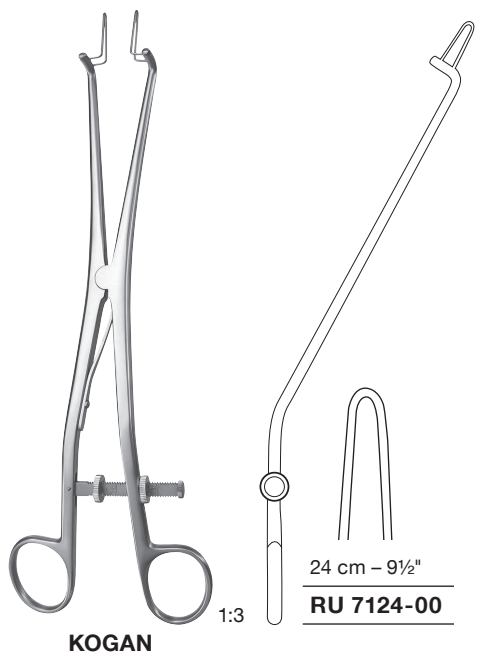

24 cm – 9½"
RU 7124-00

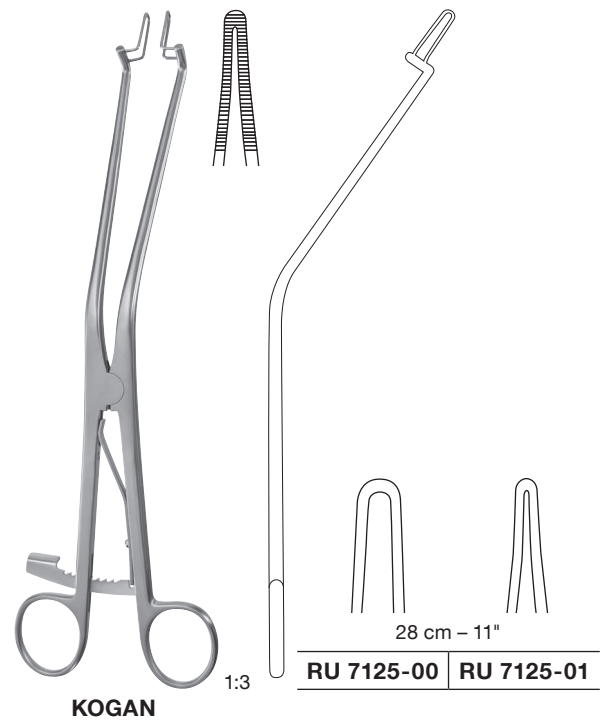

28 cm – 11"
RU 7125-00 | RU 7125-01

Uterussonden Uterine Probes

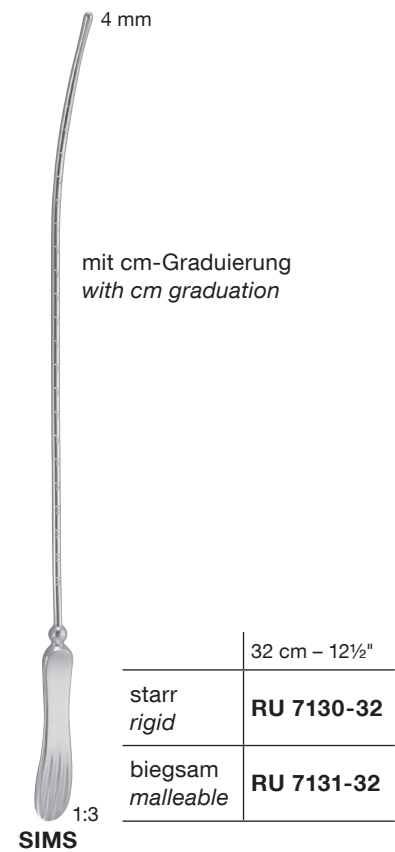
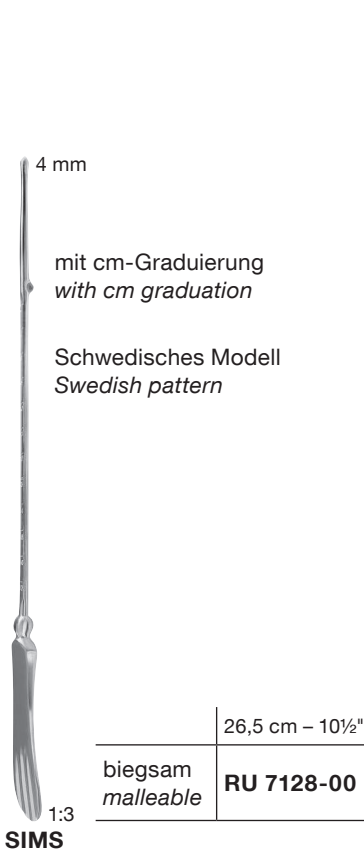

Fasszangen
Grasping Forceps



SCHACKE

23 cm – 9"
RU 7150-00



1:3

27 cm – 10½"
RU 7284-00

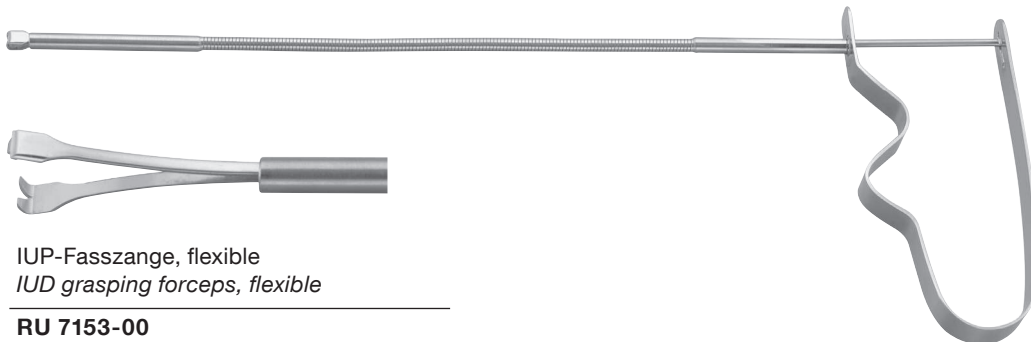

IUP-Fasszange, flexible
IUD grasping forceps, flexible

RU 7153-00

Hakenzangen Uterine Tenaculum Forceps



KAHN

24,5 cm – 9¾"
RU 7157-24



MARTIN

1:3

27 cm – 10½"
RU 7158-27



BARRETT

18 cm – 7"
RU 7159-03



SCHRÖDER

1:3

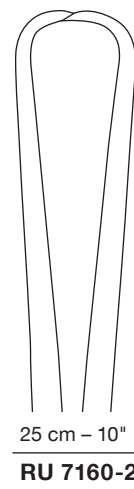

25 cm – 10"
RU 7160-25

Hakenzangen Uterine Tenaculum Forceps

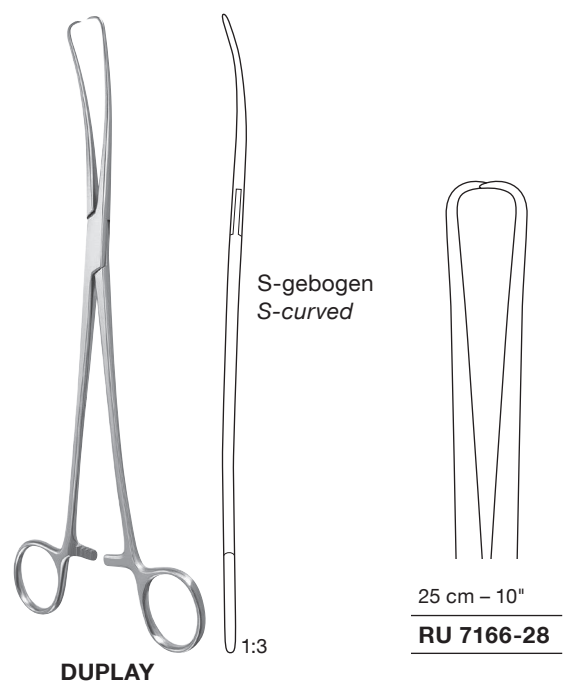

Hakenzangen Uterine Tenaculum Forceps

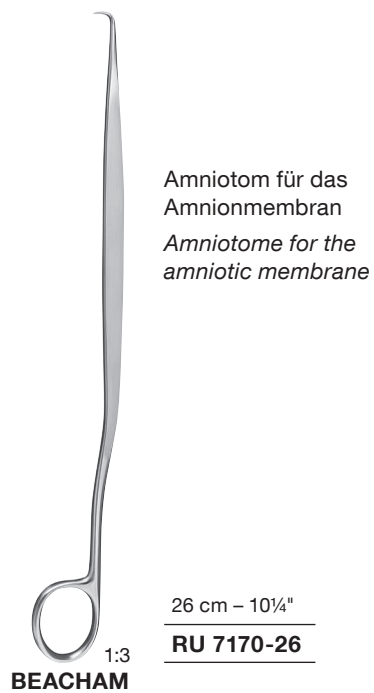
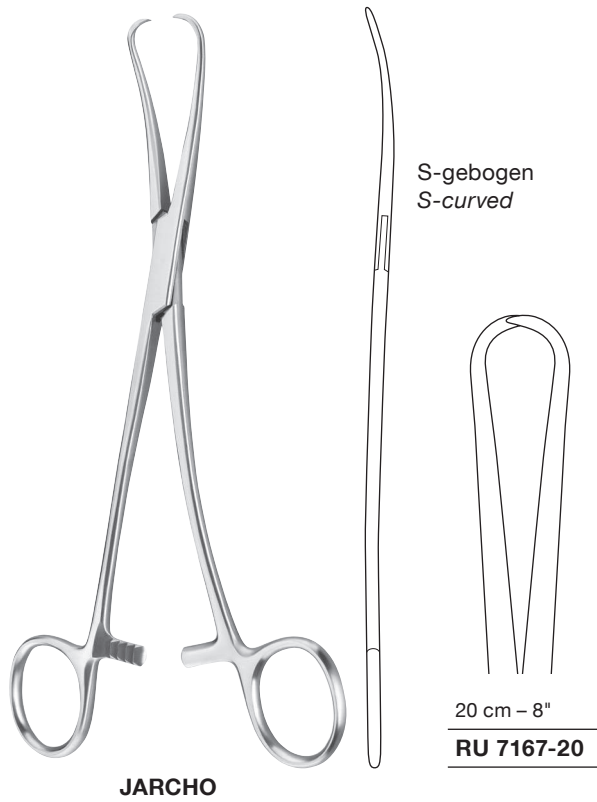

Hakenzangen
Uterine Tenaculum Forceps



PRATT



26 cm – 10¼"
RU 7178-26



BRAUN



15,5 cm – 6"
RU 7197-16

Hakenzangen Uterine Tenaculum Forceps



2 : 2 Zähne
2 : 2 teeth

SCHRÖDER



gerade
straight

20 cm – 8"	RU 7180-20
24 cm – 9½"	RU 7180-24



2 : 2 Zähne
2 : 2 teeth

SCHRÖDER



aufgebogen
curved on flat

20 cm – 8"	RU 7181-20
24 cm – 9½"	RU 7181-24



seitlich gebogen
curved sideways

	RU 7182-20
	RU 7182-24

Hakenzangen Uterine Tenaculum Forceps



MUSEUX

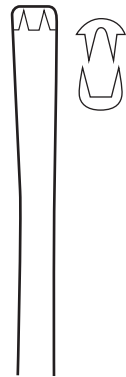

gerade
straight

21 cm – 8¼"

RU 7189-20

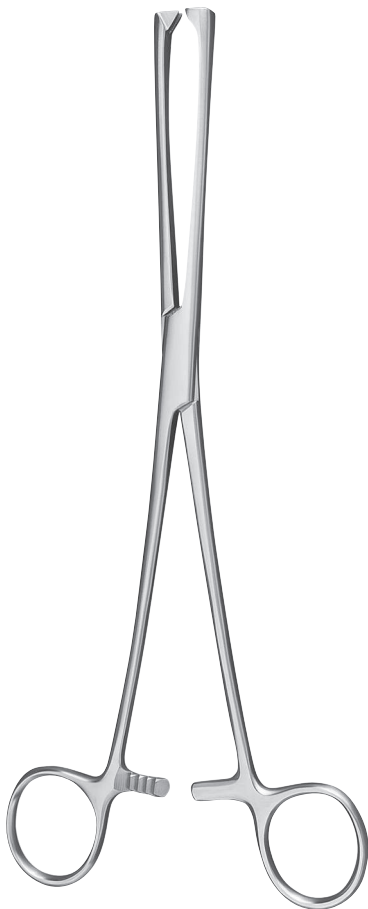

MUSEUX

1:3



gerade
straight

24 cm – 9½"

6 mm	8 mm	10 mm
RU 7190-06	RU 7190-08	RU 7190-10

Hakenzangen Uterine Tenaculum Forceps

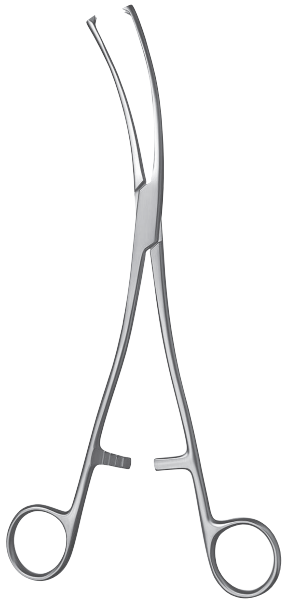

MUSEUX

1:3



seitlich gebogen
curved sideways

24 cm – 9½"

6 mm	8 mm	10 mm
RU 7191-06	RU 7191-08	RU 7191-10



TEALE



3 : 4 Zähne
3 : 4 teeth

seitlich gebogen
curved sideways

23 cm – 9"

RU 7200-23

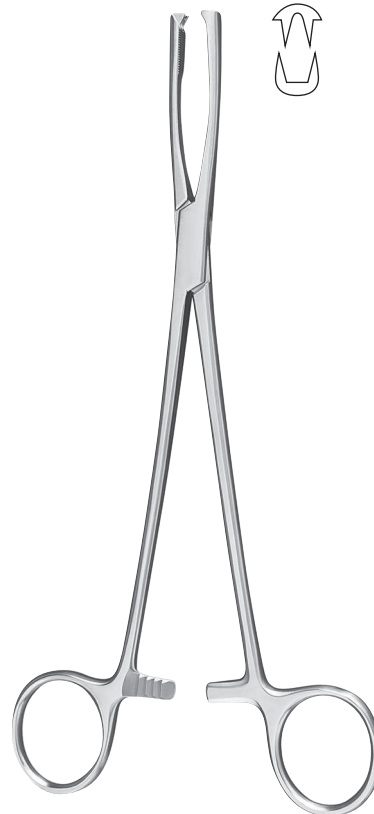

JACOBS



gerade
straight

21 cm – 8¼"

RU 7210-21

Polypen- und Ovarienzangen
 Polypus and Ovary Forceps



DE LEE

1:3



gerade
 straight

24 cm – 9½"

RU 7212-24



VAUT

1:3

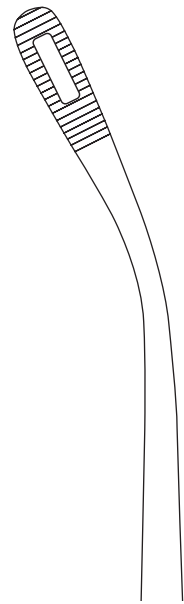

aufgebogen
 curved on flat

26 cm – 10¼"

RU 7214-26



KELLY

1:3

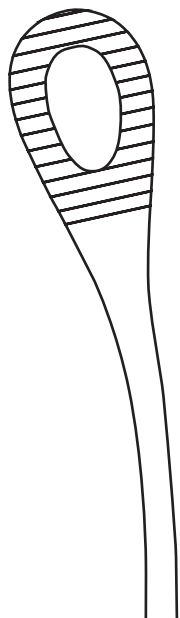

aufgebogen
 curved on flat

32 cm – 12½"

RU 7215-32



BONNEY

1:3



gerade
 straight

24 cm – 9½"

RU 7216-24

Polypen- und Ovarienzangen Polypus and Ovary Forceps

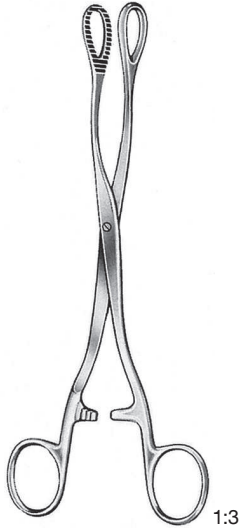

HEYWOOD-SMITH

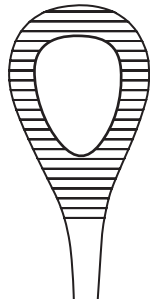

gerade
straight

20 cm – 8"

RU 6616-20



HEYWOOD-SMITH

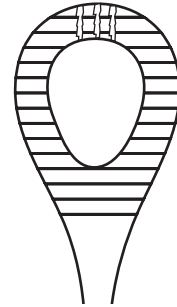

gerade
straight

25 cm – 10"

RU 7218-25



NOTO

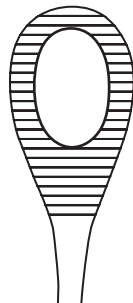

gerade
straight

27 cm – 10½"

RU 7219-27

Uterusfazzangen Uterine Elevating Forceps



DRATIGUES

1:3

27 cm – 10½"

RU 7222-27



SOMER

1:3

23 cm – 9"

RU 7223-23



mit beweglichen Maulteilen
with moveable jaws

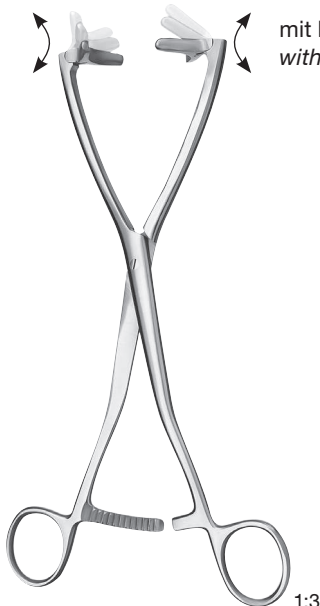

COLLIN

1:3

25 cm – 10"

RU 7224-25



COLLIN

1:3

28,5 cm – 11¼"

RU 7225-28

Uterusfazzangen Uterine Elevating Forceps

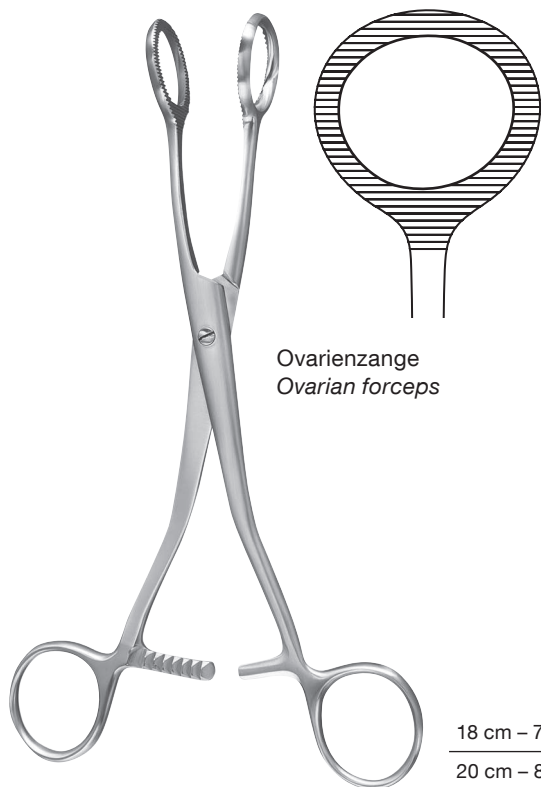

Ovarienszange
Ovarian forceps

DOYEN

18 cm – 7"	RU 7226-18
20 cm – 8"	RU 7226-20

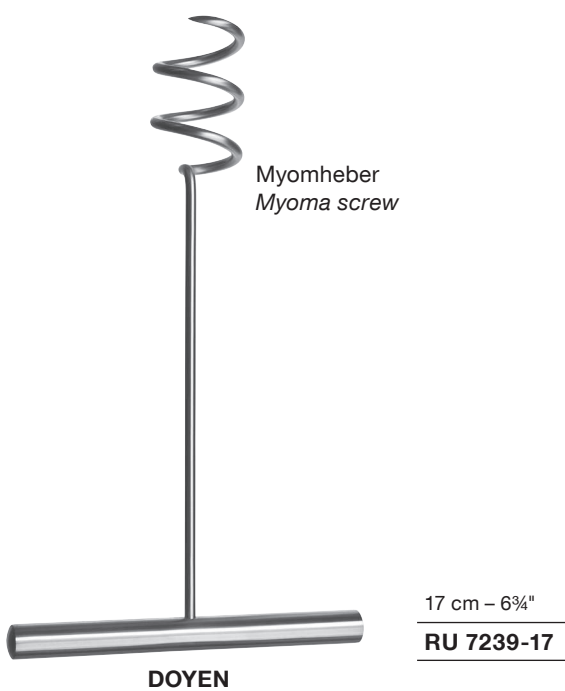
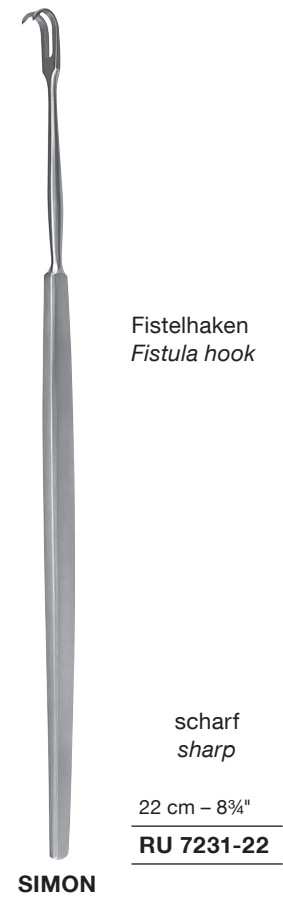
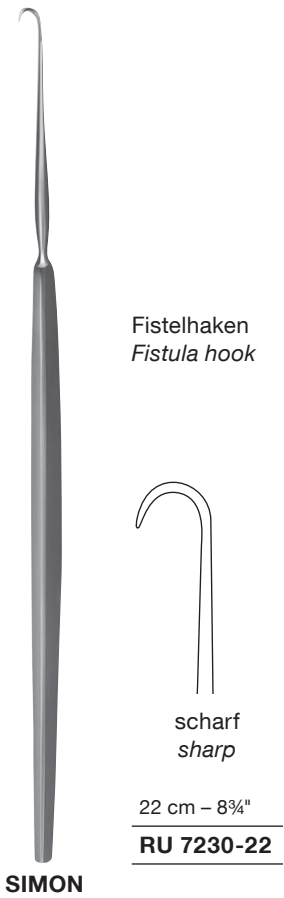

Parametriumklemmen Parametrium Forceps

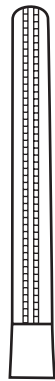

gerade
straight

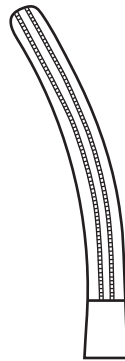

leicht gebogen
slightly curved

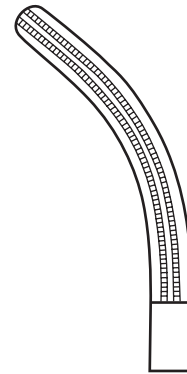

stark gebogen
strongly curved

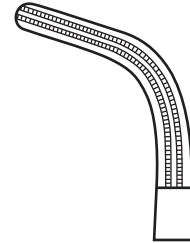

gebogen
curved

22,5 cm – 8¾"

22 cm – 8¾"

21,5 cm – 8½"

20,5 cm – 8"

RU 3383-01

RU 3383-02

RU 3383-03

RU 3383-04



DE BAKEY Zahnung
DE BAKEY Serration



ROGERS

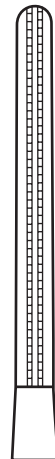

gerade
straight

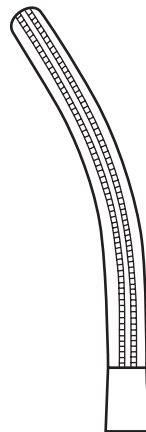

leicht gebogen
slightly curved

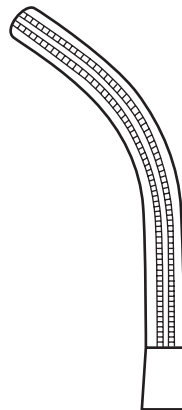

stark gebogen
strongly curved

25 cm – 10"

24,5 cm – 9¾"

24 cm – 9½"

RU 3383-51

RU 3383-52

RU 3383-53

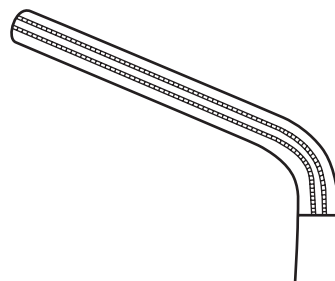

gebogen
curved

23 cm – 9"

RU 3383-54

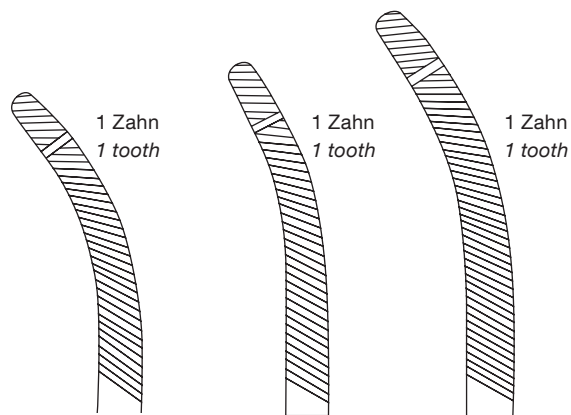

gebogen
curved

20 cm – 8"	21 cm – 8¼"	23 cm – 9"
RU 3384-19	RU 3384-21	RU 3384-23



HEANEY

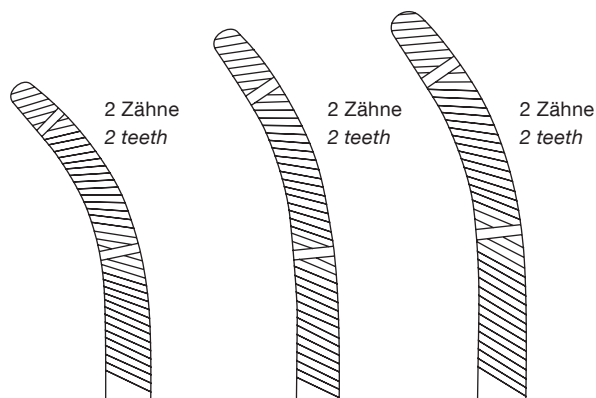

gebogen
curved

20 cm – 8"	21 cm – 8¼"	23 cm – 9"
RU 3385-19	RU 3385-21	RU 3385-23

Parametriumklemmen Parametrium Forceps



HEANEY-SLIM

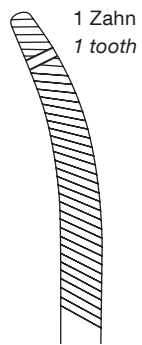

1 Zahn
1 tooth

gebogen
curved

21 cm – 8¼"

RU 3384-41

Hysterektomieklemmen Hysterectomy Forceps

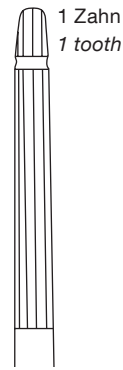

gerade
straight

21 cm – 8¼"

RU 3386-01

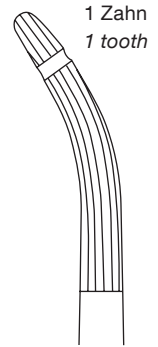

gebogen
curved

21 cm – 8¼"

RU 3386-11



gerade
straight

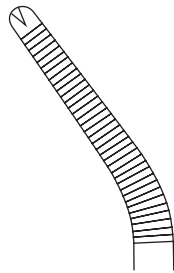

gebogen
curved

21,5 cm – 8½"

RU 3388-20

RU 3389-20



gerade
straight

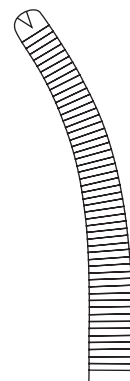

gebogen
curved

23,5 cm – 9¼"

RU 3420-23

RU 3421-23

Hysterektomieklemmen Hysterectomy Forceps

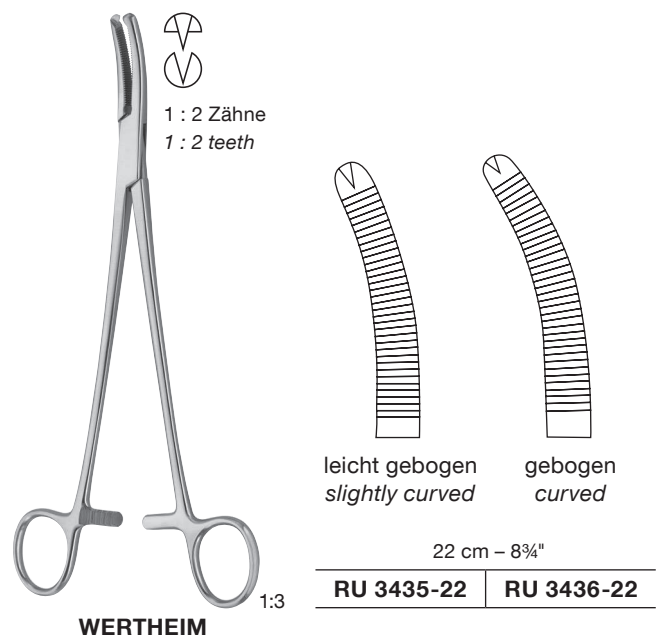
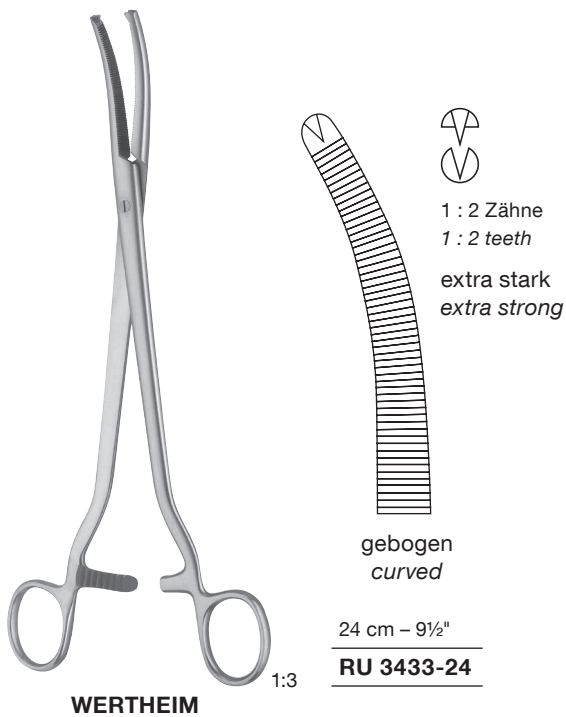
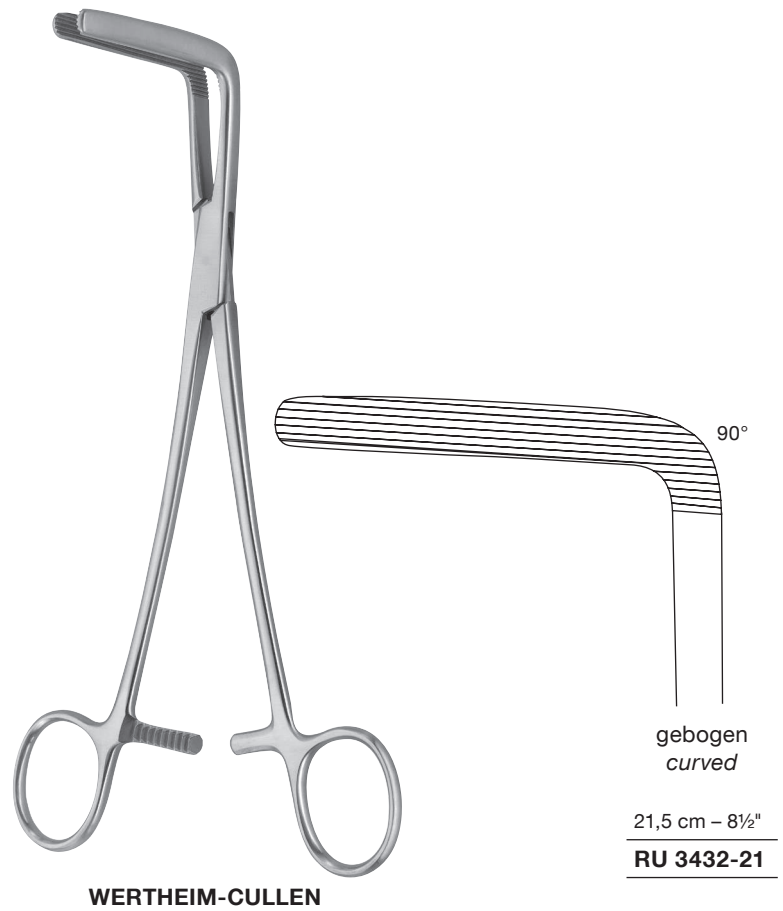
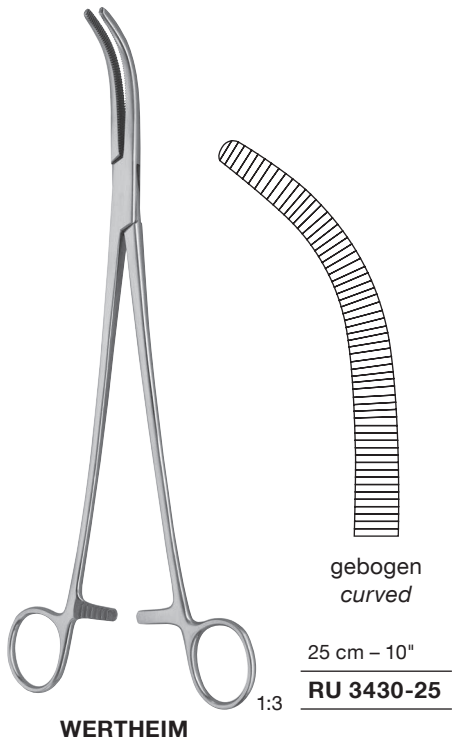

Vaginalklemmen Vaginal Forceps

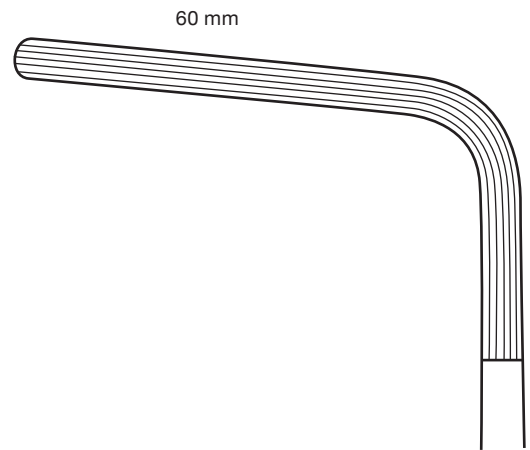

60 mm

23 cm – 9"

RU 3434-01

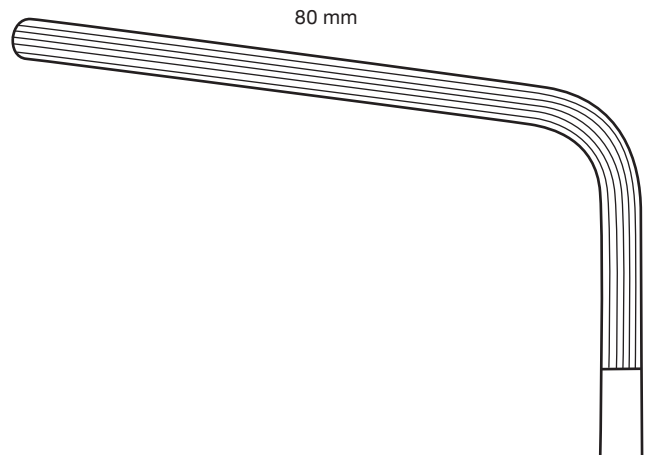

80 mm

23 cm – 9"

RU 3434-02

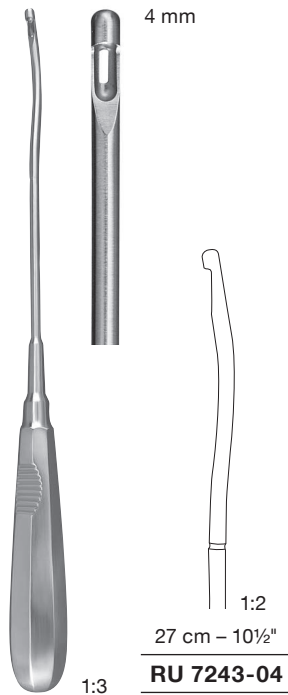

**MÜNCHEN MODELL
MUNICH PATTERN**

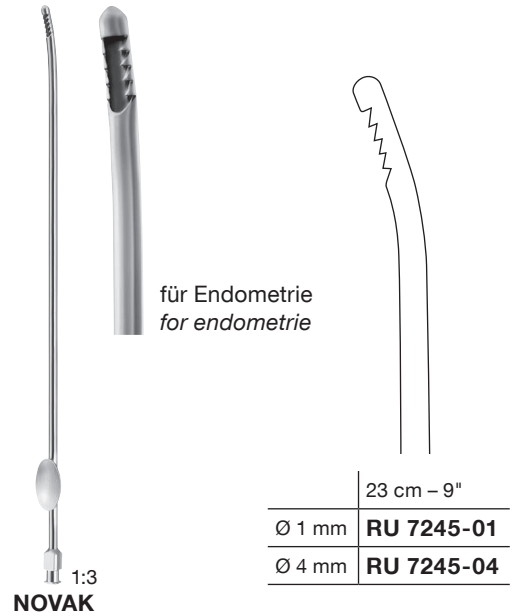

NOVAK

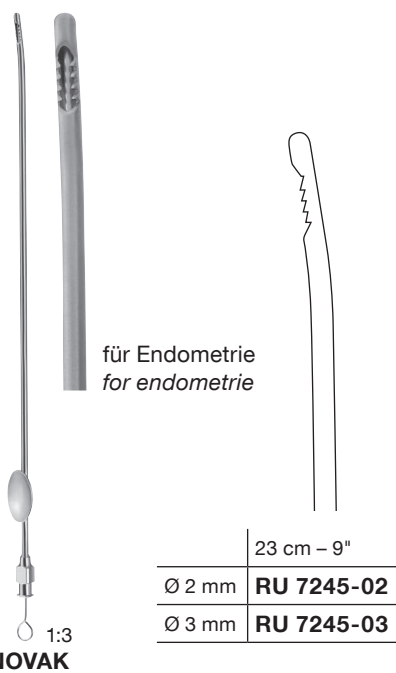

NOVAK

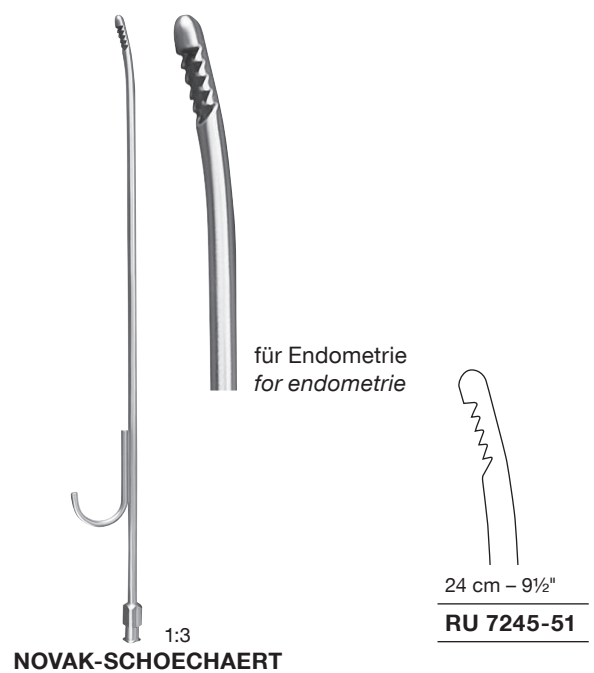

NOVAK-SCHOECHAERT

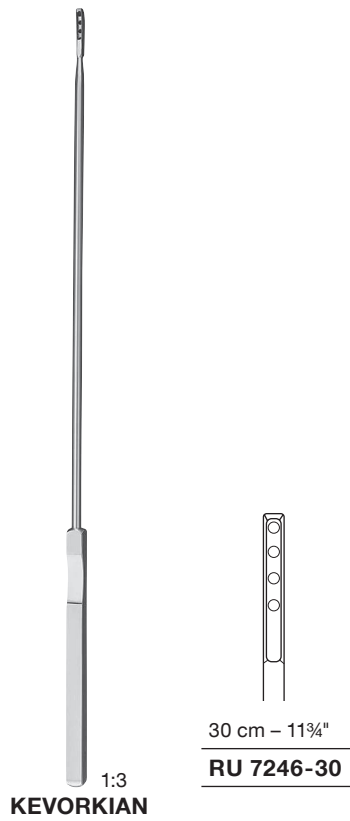

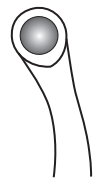

24 cm – 9½"
RU 7252-24

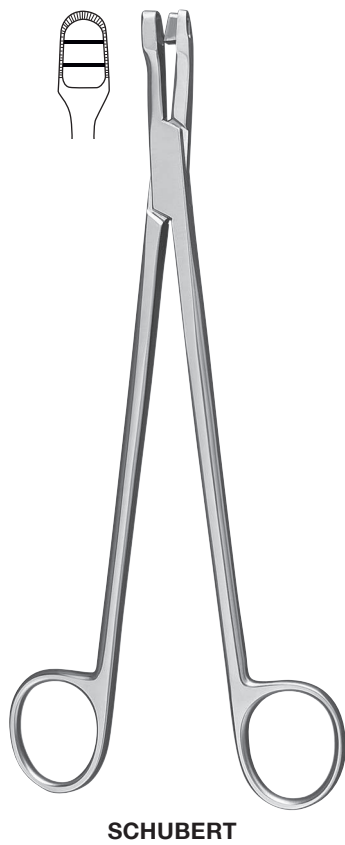

21 cm – 8¼" | **RU 7255-21**
29 cm – 11½" | **RU 7255-29**

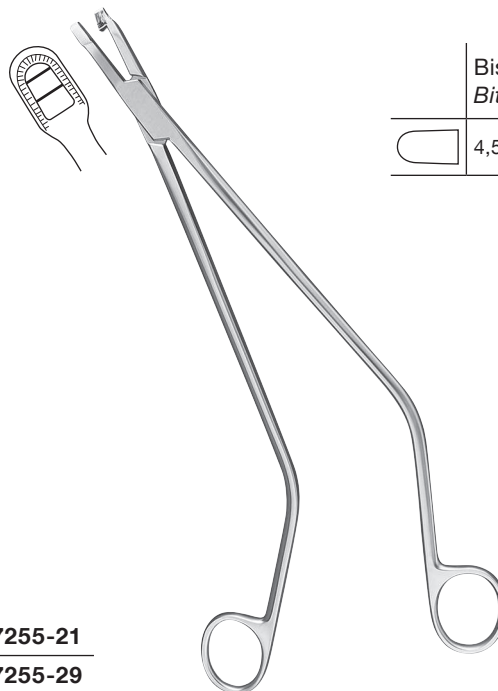

	Bissbreite Bite width
	4,5 x 8 mm

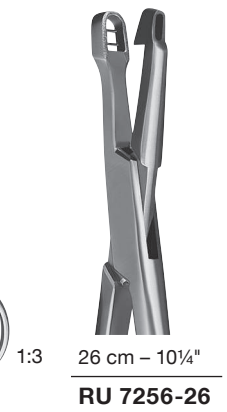



TISCHLER

27 cm – 10½"
RU 7257-27

Bissbreite Bite width	
	4 x 7 mm

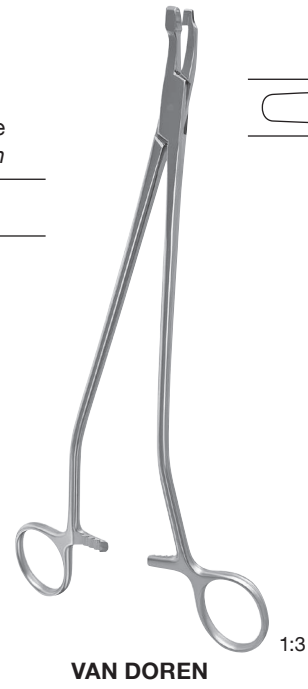

VAN DOREN

25 cm – 10"
RU 7258-01

Bissbreite Bite width	
	3,5 / 4 x 7 mm

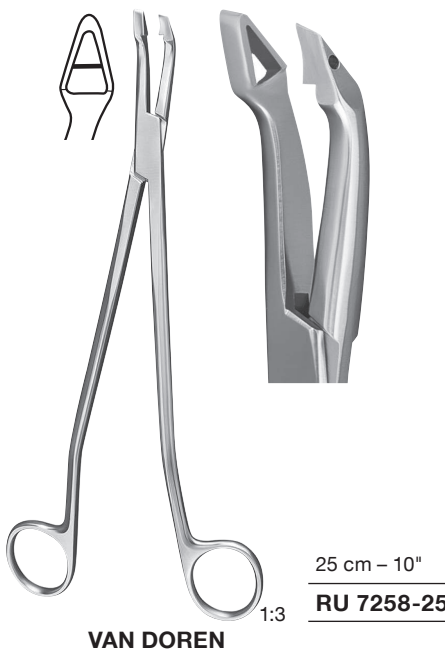

VAN DOREN

25 cm – 10"
RU 7258-25



SCHUMACHER

24 cm – 9½"	
Fig. 1	Fig. 2
RU 7261-24	RU 7262-24



FAURE

21 cm – 8¼"
RU 7263-21

Biopsiezangen Biopsy Forceps

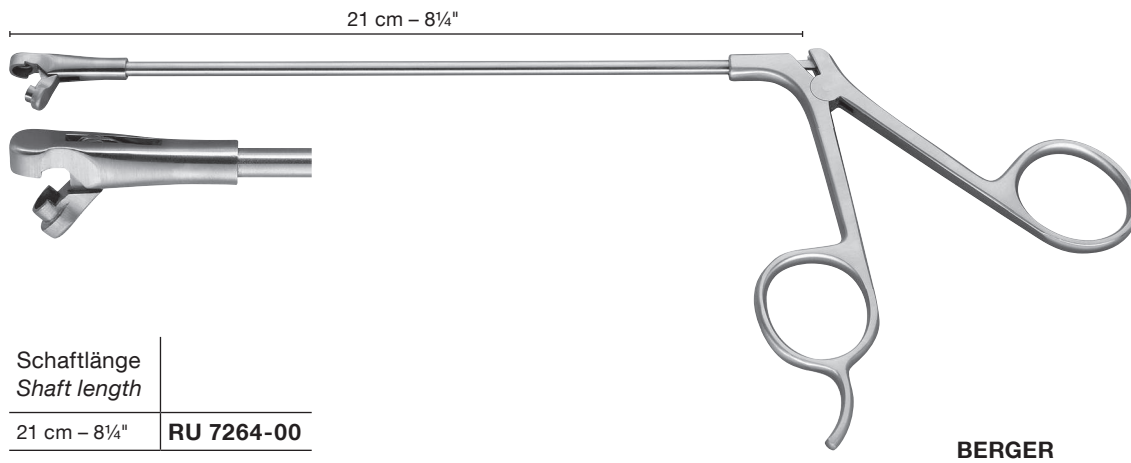
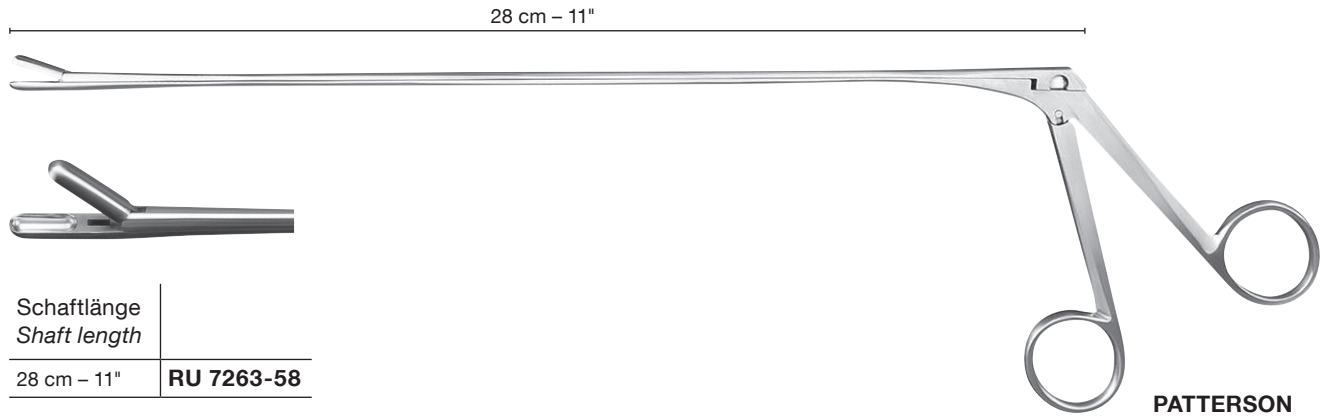







	Bissbreite Bite width	Schaftlänge Shaft length	DOUAY
	4 x 10 mm	20 cm – 8"	RU 7264-10/20
		25 cm – 10"	RU 7264-10/25
		30 cm – 11¼"	RU 7264-10/30

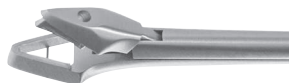

	Bissbreite Bite width	Schaftlänge Shaft length	EPPENDORF
	4 x 8 mm	20 cm – 8"	RU 7267-00
			RU 7267-00P



	Schaftlänge Shaft length	Bissbreite Bite width	SCHUMACHER
	24 cm – 9½"	4 mm	RU 7265-00
	24 cm – 9½"	4 mm	RU 7265-00P
	24 cm – 9½"	6 mm	RU 7265-06
	24 cm – 9½"	6 mm	RU 7265-06P





	Bissbreite Bite width	Schaftlänge Shaft length	KEVORKIAN
	3 x 8 mm	24 cm – 9½"	RU 7266-00
			RU 7266-00P

ProClean = verbesserte Reinigung dank zerlegbarem Schiebeschaft
Erkennungsmerkmal: zusätzlich endet die Artikelnummer mit dem Buchstaben „P“

ProClean = improved cleaning by dismountable sliding sheath
Identifying feature: additionally the article number ends with the letter "P"

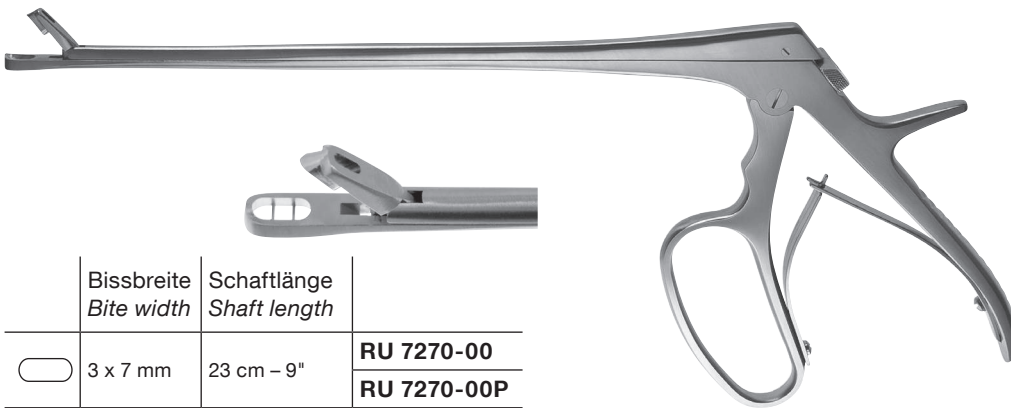
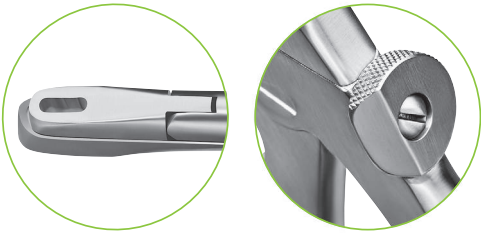
Biopsiezangen Biopsy Forceps



	Bissbreite <i>Bite width</i>	Schaftlänge <i>Shaft length</i>	
	3 x 7 mm	23 cm – 9"	RU 7270-00
			RU 7270-00P

TISCHLER-MORGAN



	Bissbreite <i>Bite width</i>	Schaftlänge <i>Shaft length</i>	
	2,3 x 6,5 mm	21 cm – 8¼"	RU 7270-50
			RU 7270-50P

BABY-TISCHLER

Uterus-Biopsiezangen Uterine Biopsy Forceps

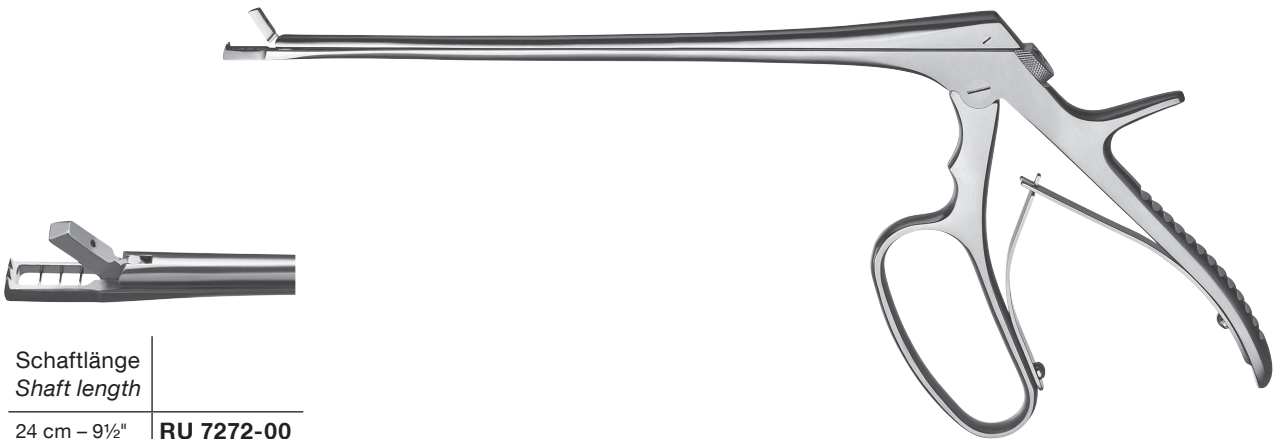

Schaftlänge Shaft length	
24 cm – 9½"	RU 7272-00

PACIFIC-KEVORKIAN

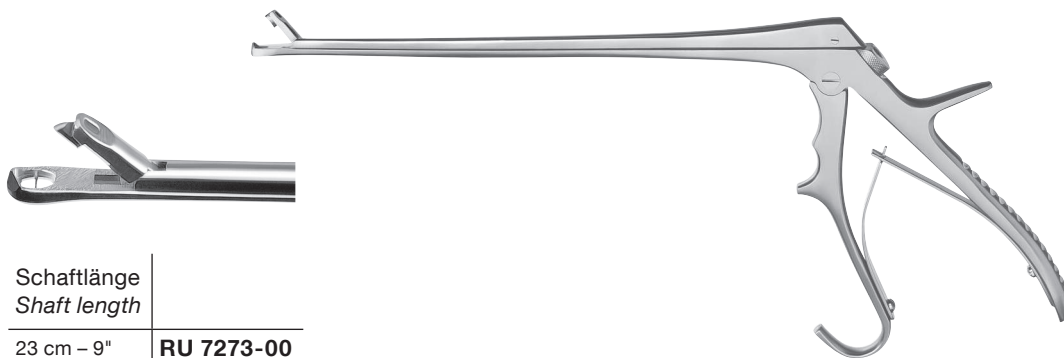

Schaftlänge Shaft length	
23 cm – 9"	RU 7273-00

BURKE

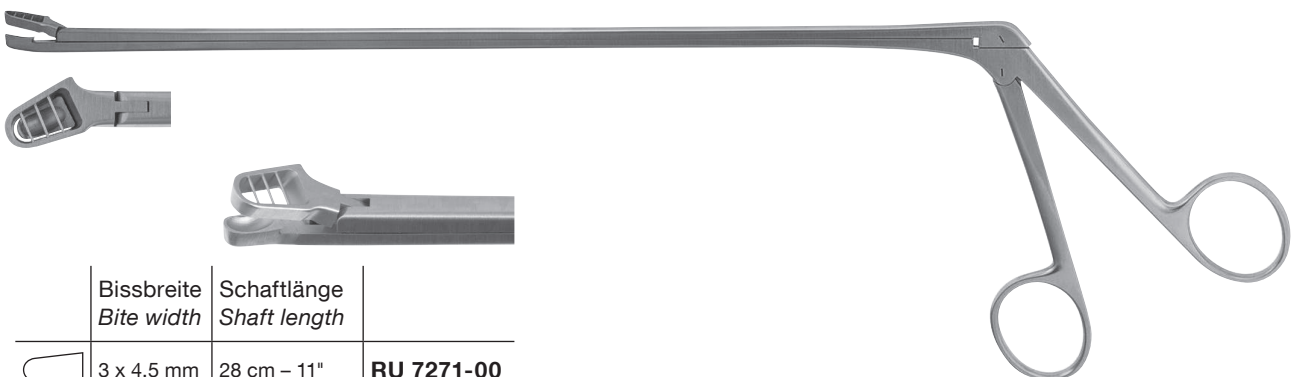

	Bissbreite Bite width	Schaftlänge Shaft length	
	3 x 4,5 mm	28 cm – 11"	RU 7271-00

ALEXANDER

Uterus-Biopsiezangen Uterine Biopsy Forceps

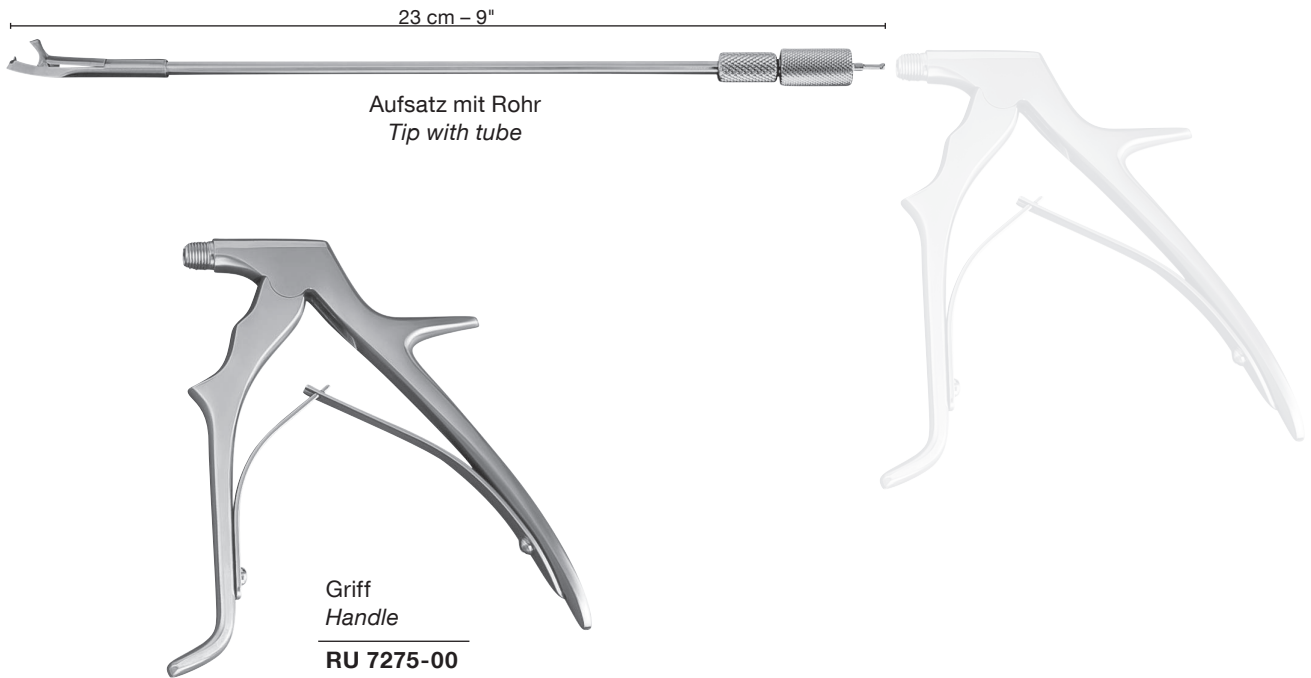

TISCHLER

Länge <i>length</i>	Bissbreite <i>Bite width</i>	Aufsatz, allein, gerade <i>Tip, only, straight</i>	Instrument komplett <i>Instrument complete</i>
23 cm - 9"	3 x 7 mm	RU 7275-10	RU 7275-11



MINI-TOWNSEND-UP

Länge <i>length</i>	Bissbreite <i>Bite width</i>	Aufsatz, allein, aufwärts gebogen, <i>Tip, only, curved up</i>	Instrument komplett <i>Instrument complete</i>
23 cm - 9"	2,3 x 5 mm	RU 7275-70	RU 7275-71



MINI-TOWNSEND-DOWN

Länge <i>length</i>	Bissbreite <i>Bite width</i>	Aufsatz, allein, abwärts gebogen, <i>Tip, only, curved down</i>	Instrument komplett <i>Instrument complete</i>
23 cm - 9"	2,3 x 5 mm	RU 7275-80	RU 7275-81

Uteruslöffel Uterine Scoops

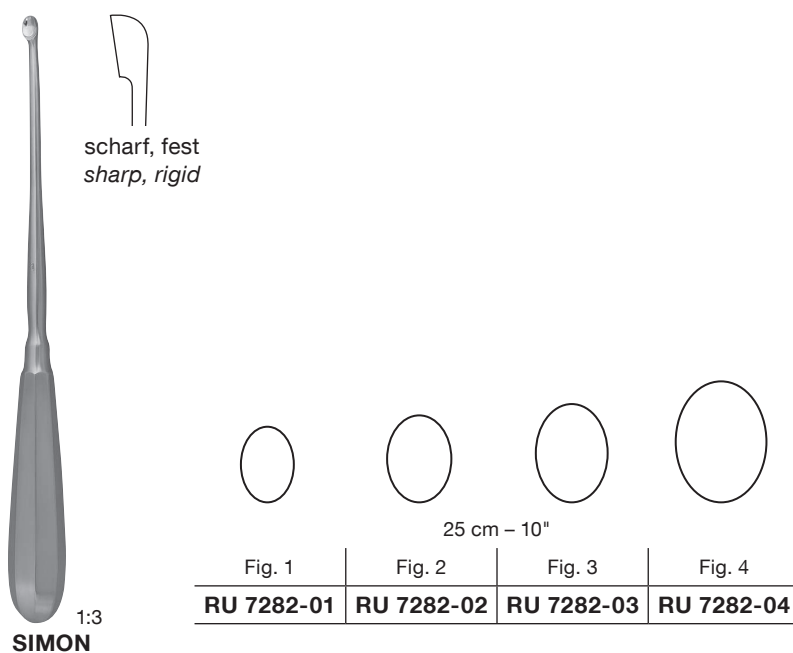
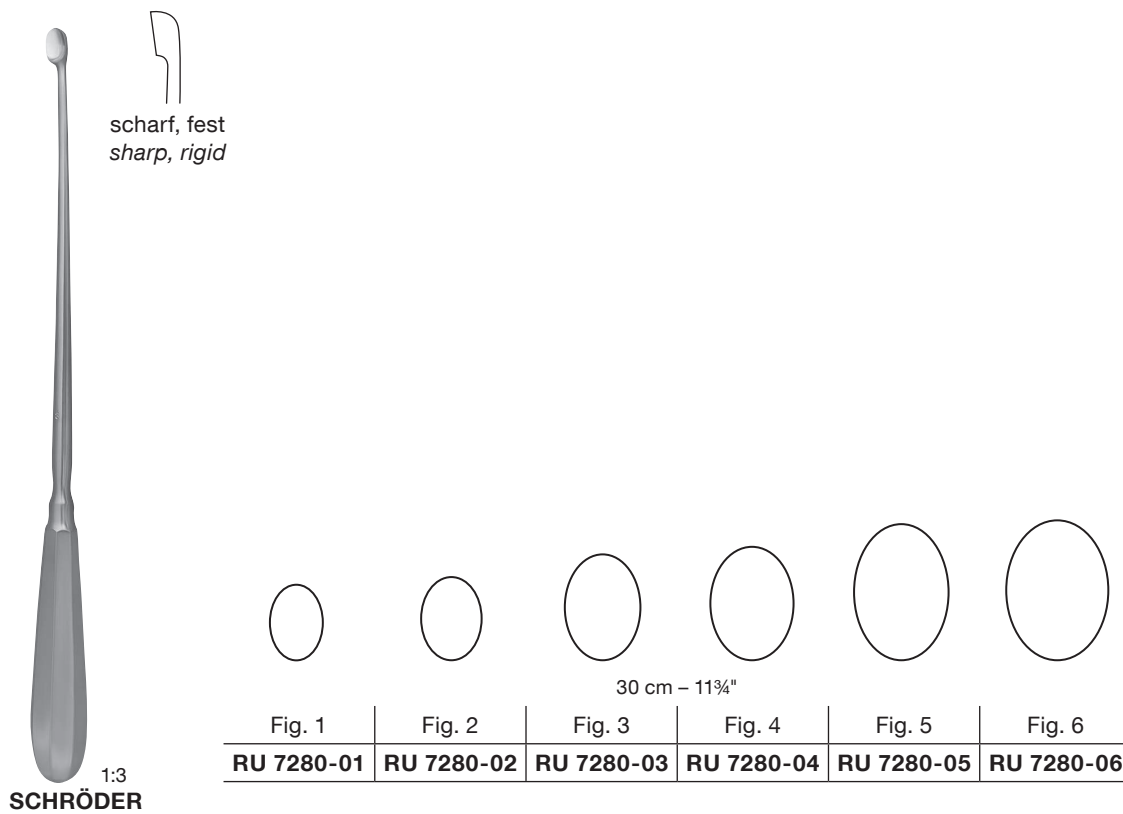

Uterusküretten Uterine Curettes

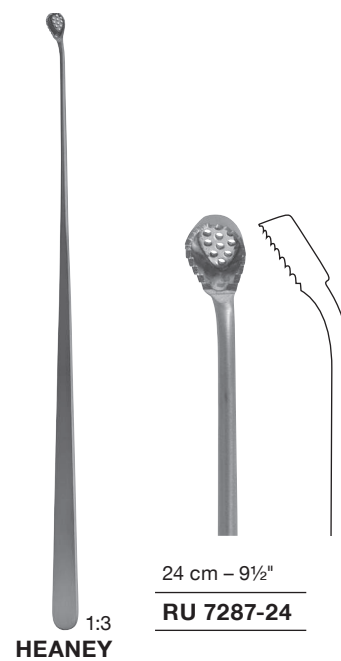
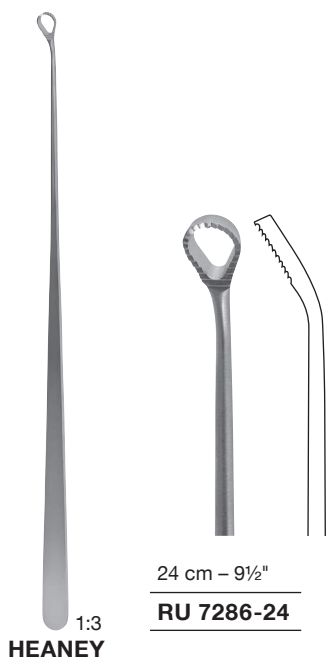
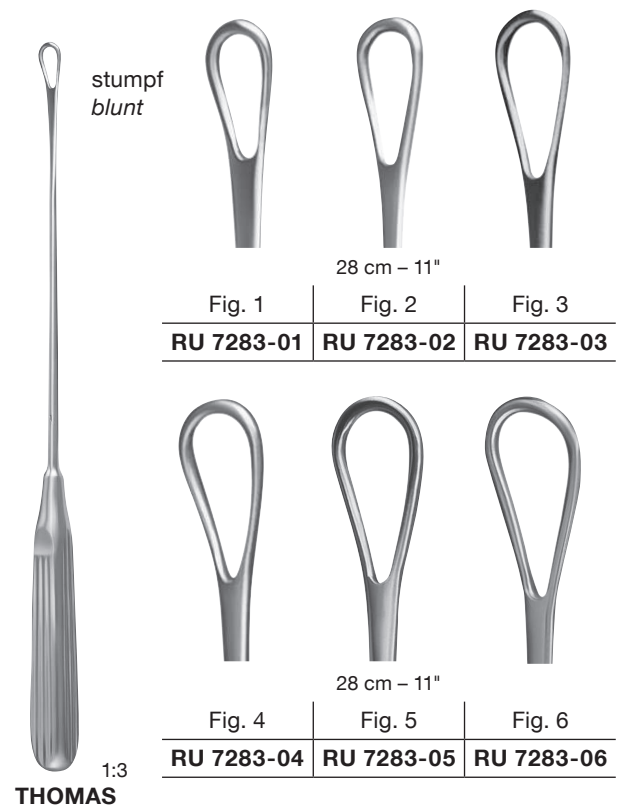
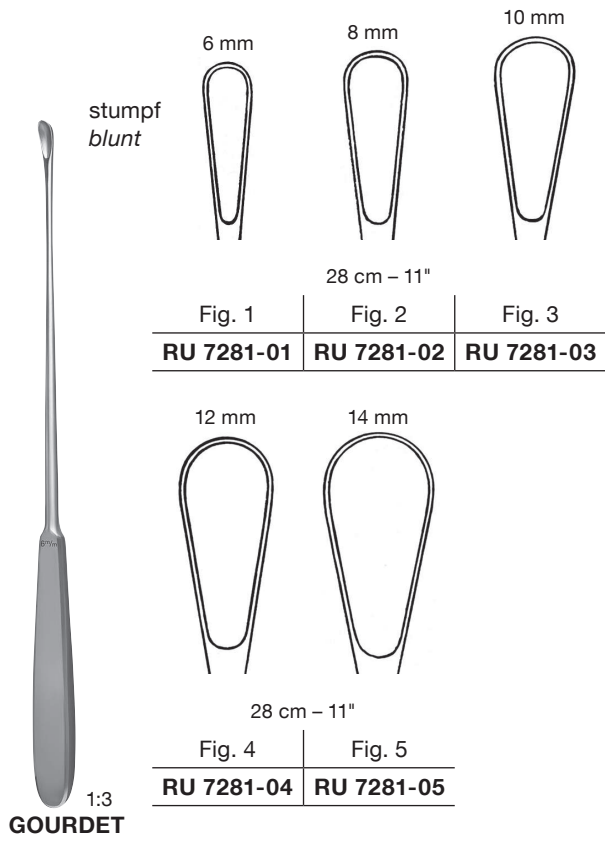

Uterusküretten Uterine Curettes

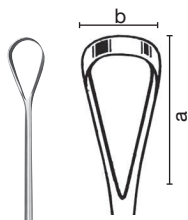

28 cm – 11"

	Fig. 1	Fig. 2	Fig. 3	Fig. 4	Fig. 5	Fig. 6
a x b	15 x 7,5 mm	17,5 x 8,5 mm	20 x 10,5 mm	22 x 12 mm	24 x 14 mm	28 x 15 mm
biegsam, scharf <i>malleable, sharp</i>	RU 7300-01	RU 7300-02	RU 7300-03	RU 7300-04	RU 7300-05	RU 7300-06
biegsam, stumpf <i>malleable, blunt</i>	RU 7302-01	RU 7302-02	RU 7302-03	RU 7302-04	RU 7302-05	RU 7302-06
fest, scharf <i>rigid, sharp</i>	RU 7304-01	RU 7304-02	RU 7304-03	RU 7304-04	RU 7304-05	RU 7304-06
fest, stumpf <i>rigid, blunt</i>	RU 7306-01	RU 7306-02	RU 7306-03	RU 7306-04	RU 7306-05	RU 7306-06

1:3
SIMS

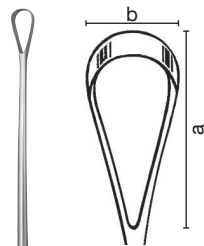

26 cm – 10¼"

Fig.	a x b mm	26 cm – 10¼"		
		biegsam <i>malleable</i>	fest <i>rigid</i>	fest <i>rigid</i>
		scharf <i>sharp</i>	scharf <i>sharp</i>	stumpf <i>blunt</i>
00	9 x 5	RU 7310-05	RU 7314-05	RU 7316-05
0	12 x 6	RU 7310-06	RU 7314-06	RU 7316-06
1	14 x 7	RU 7310-07	RU 7314-07	RU 7316-07
2	16 x 8	RU 7310-08	RU 7314-08	RU 7316-08
3	18 x 9	RU 7310-09	RU 7314-09	RU 7316-09
4	22 x 11	RU 7310-11	RU 7314-11	RU 7316-11
5	24 x 12	RU 7310-12	RU 7314-12	RU 7316-12
6	28 x 14	RU 7310-14	RU 7314-14	RU 7316-14
7	33 x 15	RU 7310-15	RU 7314-15	RU 7316-15
8	35 x 16	RU 7310-16	RU 7314-16	RU 7316-16

1:3
RECAMIER

Uterusküretten Uterine Curettes

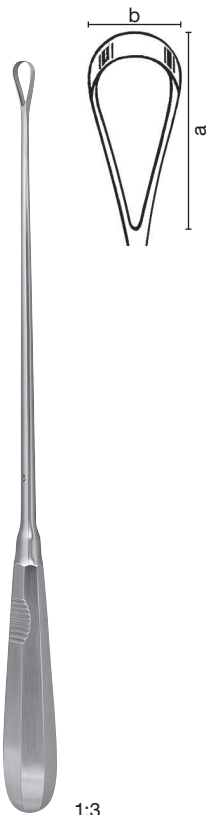

1:3
RECAMIER

Fig.	a x b mm	biegsam <i>malleable</i>	fest <i>rigid</i>	fest <i>rigid</i>
		<i>scharf</i> <i>sharp</i>	<i>scharf</i> <i>sharp</i>	<i>stumpf</i> <i>blunt</i>
31 cm – 12¼"				
00	9 x 5	RU 7318-05	RU 7322-05	RU 7324-05
0	12 x 6	RU 7318-06	RU 7322-06	RU 7324-06
1	14 x 7	RU 7318-07	RU 7322-07	RU 7324-07
2	16 x 8	RU 7318-08	RU 7322-08	RU 7324-08
3	18 x 9	RU 7318-09	RU 7322-09	RU 7324-09
4	22 x 11	RU 7318-11	RU 7322-11	RU 7324-11
5	24 x 12	RU 7318-12	RU 7322-12	RU 7324-12
6	28 x 14	RU 7318-14	RU 7322-14	RU 7324-14
7	33 x 15	RU 7318-15	RU 7322-15	RU 7324-15
8	35 x 16	RU 7318-16	RU 7322-16	RU 7324-16
9	38 x 19	RU 7318-19	RU 7322-19	RU 7324-19
10	40 x 20	RU 7318-20	RU 7322-20	RU 7324-20
11	45 x 21	RU 7318-21	RU 7322-21	RU 7324-21
12	48 x 23	RU 7318-23	RU 7322-23	RU 7324-23
34 cm – 13½"				
13	50 x 25	RU 7318-25	RU 7322-25	RU 7324-25
14	55 x 30	RU 7318-30	RU 7322-30	RU 7324-30
15	60 x 35	RU 7318-35	RU 7322-35	RU 7324-35
16	65 x 40	RU 7318-40	RU 7322-40	RU 7324-40

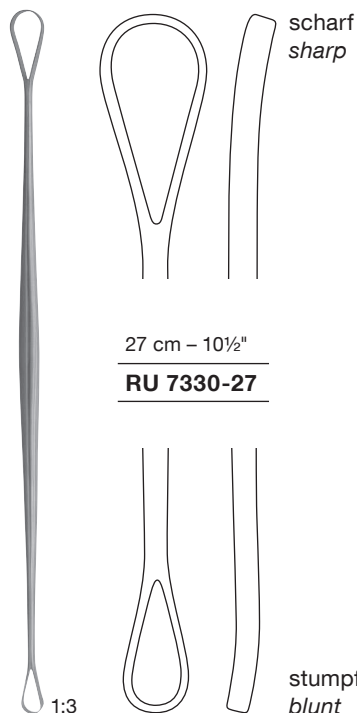

1:3
BLAKE

Biopsie- und Absaugküretten Biopsy and Aspirating Curettes



graduiert
graduated

Ø mm	28 cm – 11"
4	RU 7289-04
6	RU 7289-06
8	RU 7289-08
10	RU 7289-10
12	RU 7289-12
14	RU 7289-14

1:3



Schlauch-Verbindungstück
Tube connecting piece

RU 7289-50



1:3

MILAN



Ø 5 mm

biegsam
malleable

RU 7290-05



Ø 7 mm

28,5 cm – 11¼"

RU 7290-07



Ø 9 mm

RU 7290-09



SCHULTZE

Salpingograph zur Hystereo-Salpingographie
komplett in Holzetui, bestehend aus:

RU 7350-00

*Salpingograph for utero-salpingography
complete in wooden case, consisting of:*

- 1 Manometer (RU 7350-01)
- 1 Manometer (RU 7350-01)
- 1 Zwischenstück, ohne Manometer (RU 7350-02)
- 1 Connection, without manometer (RU 7350-02)
- 1 Tubenkatheter mit Hahn, ohne Kugel (RU 7350-03)
- 1 Uterine cannula with tap, without cone (RU 7350-03)
- 1 Kegel, klein (RU 7350-04)
- 1 Cone, small (RU 7350-04)
- 1 Kegel, mittel (RU 7350-05)
- 1 Cone, medium (RU 7350-05)
- 1 Kegel, groß (RU 7350-06)
- 1 Cone, large (RU 7350-06)
- 1 Holzetui (RU 7350-20)
- 1 Wooden case (RU 7350-20)

Manometer
Manometer

RU 7350-01



Zwischenstück
Connection

RU 7350-02



Tubenkatheter
mit Hahn, ohne Kugel
Uterine cannula
with tap, without cone

RU 7350-03



klein
small

RU 7350-04



mittel
medium

RU 7350-05



groß
large

RU 7350-06

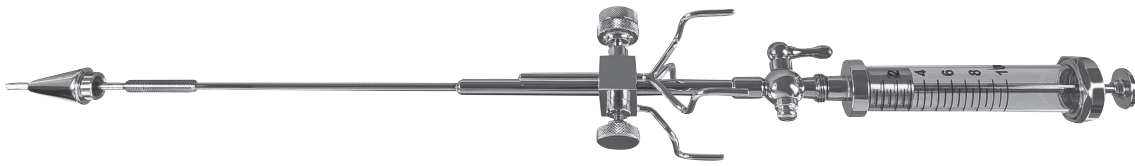

SCHULTZE

Salpingograph zur Hystereo-Salpingographie
komplett in Holzetui, bestehend aus:

*Salpingograph for utero-salpingography
complete in wooden case, consisting of:*

RU 7360-00

- 1 Zwischenstück, ohne Manometer (RU 7350-02)
- 1 Connection, without manometer (RU 7350-02)
- 1 Tubenkatheter mit Hahn, ohne Kugel (RU 7350-03)
- 1 Uterine cannula with tap, without cone (RU 7350-03)
- 1 Kegel, klein (RU 7350-04)
- 1 Cone, small (RU 7350-04)
- 1 Kegel, mittel (RU 7350-05)
- 1 Cone, medium (RU 7350-05)
- 1 Kegel, groß (RU 7350-06)
- 1 Cone, large (RU 7350-06)
- 1 Holzetui (RU 7350-20)
- 1 Wooden case (RU 7350-20)

Zwischenstück
Connection

RU 7350-02



Tubenkatheter
mit Hahn, ohne Kugel
Uterine cannula
with tap, without cone

RU 7350-03



klein
small

mittel
medium

groß
large

RU 7350-04

RU 7350-05

RU 7350-06



14 cm – 5½"
RU 3426-14

DE MARTEL (WILLET)



19 cm – 7½"
RU 7420-19

DE MARTEL (WILLET)

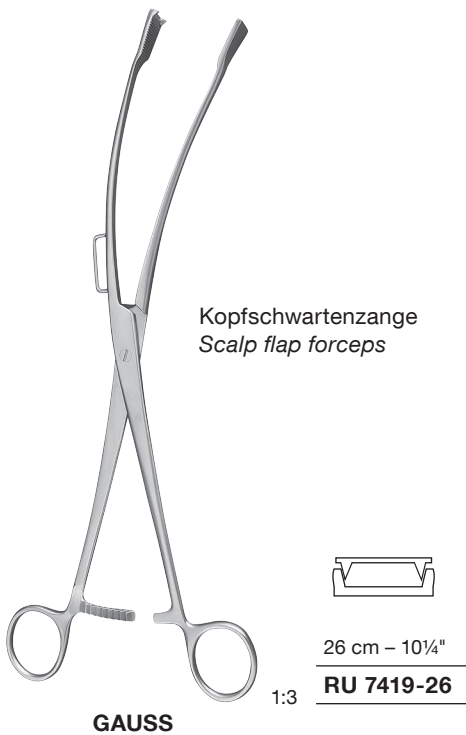

Kopfschwartenzange
Scalp flap forceps

26 cm – 10¼"
RU 7419-26

GAUSS



Geburtslöffel
Elevating spoon

28 cm – 11"
RU 7425-28

SELLHEIM



Perforatorium
Perforator

25 cm – 10"

RU 7432-25

NÄGELE



Nabelschnurklemme
Umbilical cord clamp

9 cm – 3½"

RU 7436-29

COLLIN



1:4
SIMPSON-LUIKART

36,5 cm – 14½"
RU 7447-36



1:3
SIMPSON

23 cm – 9"
RU 7445-23



1:4
SIMPSON

30 cm – 11¼"
RU 7445-30



1:4
WRIGLEY

28 cm – 11"
RU 7442-28



MC LEAN

1:4

36 cm – 14¼"
RU 7463-36



SIMPSON-BRAUN

1:4

36 cm – 14¼"
RU 7446-36



NÄGELE

1:4

36 cm – 14¼"	RU 7440-36
40 cm – 15¾"	RU 7440-40



KIELLAND

1:4

41 cm – 16¼"	RU 7460-41
--------------	-------------------

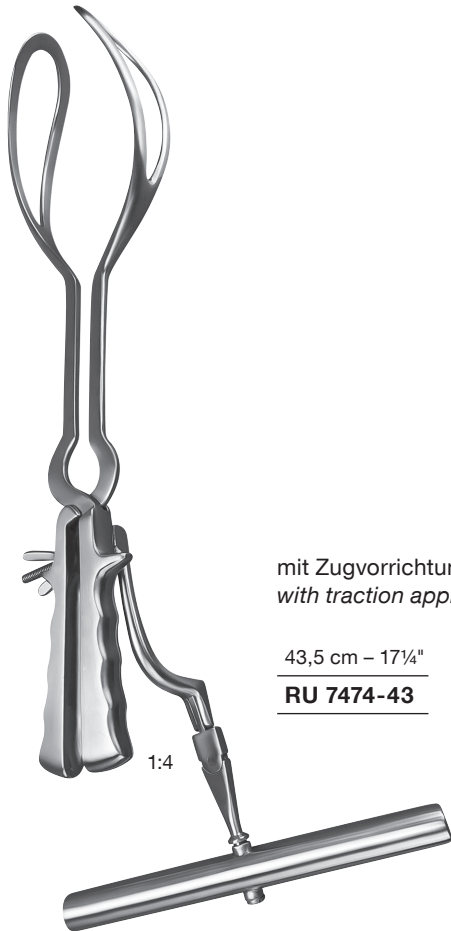

mit Zugvorrichtung
with traction appliance

43,5 cm – 17¼"

RU 7474-43

1:4

BARNES-NEVILLE



für nachkommenden
Kopf bei Steisslagen
*for delivery of the after
coming head in breech
presentation*

44 cm – 17¼"

RU 7472-44

1:4

PIPER

Abortuszangen
Ovum Forceps

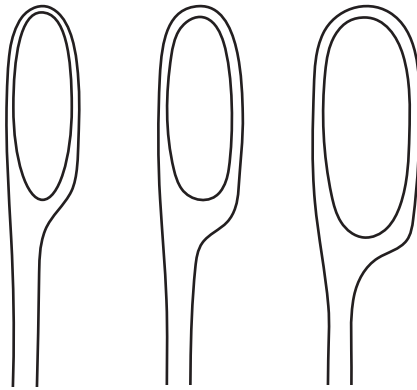

gerade
straight

28 cm – 11"

RU 7410-01	RU 7410-02	RU 7410-03
-------------------	-------------------	-------------------

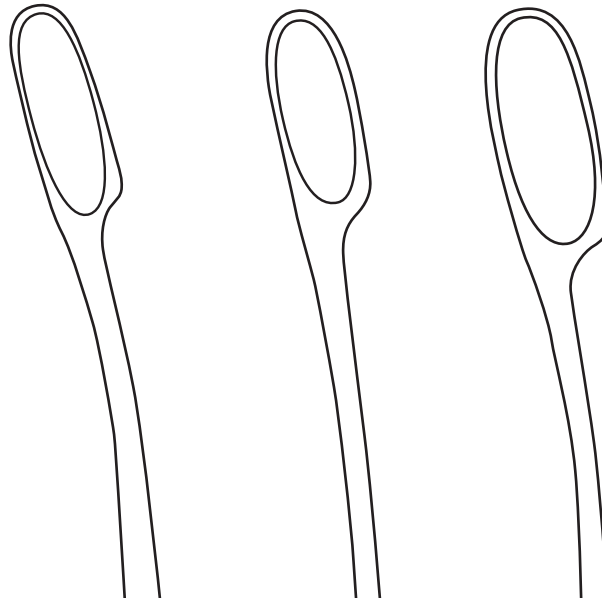

gebogen
curved

28 cm – 11"

RU 7411-01	RU 7411-02	RU 7411-03
-------------------	-------------------	-------------------

Abortus- und Plazentarzangen

Ovum and Placenta Forceps



Abortuszangen
Ovum forceps

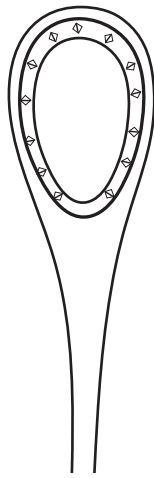

gerade
straight

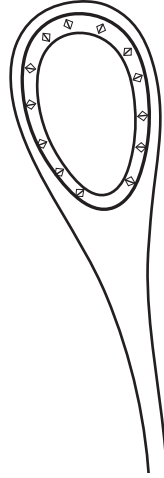

gebogen
curved

27 cm – 10½"

RU 7414-27

RU 7415-27



Plazentazange
Placenta forcep

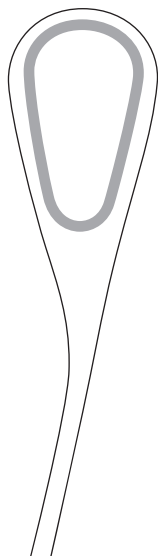

leicht gebogen
slightly curved

25,5 cm – 10"

RU 7413-25

Uterusklemmzangen
Uterine Forceps

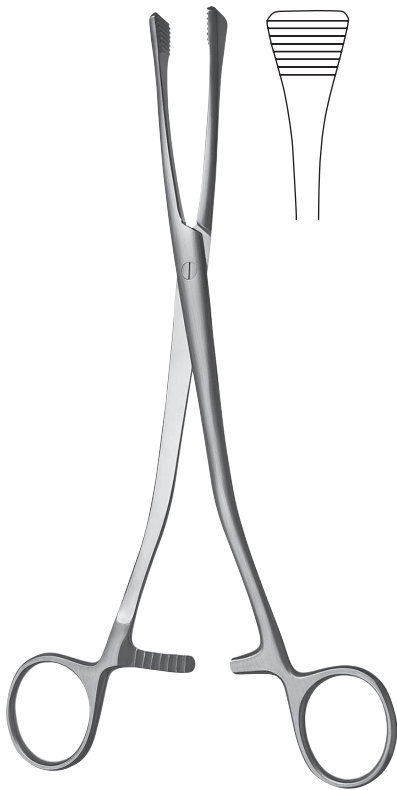

GREEN-ARMYTAGE

21 cm – 8¼"

RU 7418-21



Meißel und Osteotome	<i>Chisels and Osteotomes</i>	BS 1 - 8
Scharfe Löffel	<i>Bone Curettes</i>	BS 9 - 15
Knochenraspel	<i>Bone Rasps</i>	BS 16
Rasparatorien	<i>Raspatories</i>	BS 17 - 24
Rasparatorien und Elevatorien	<i>Raspatories and Elevators</i>	BS 25
Elevatorien	<i>Elevators</i>	BS 26 - 27
Knochenhebel	<i>Bone Levers</i>	BS 28 - 31
Knochenhaken	<i>Bone Retractors</i>	BS 32 - 34
Spinalhaken, Meniskusmesser	<i>Spinal Retractors, Meniscus Knives</i>	BS 35
Knochenhaltezangen	<i>Bone Holding Forceps</i>	BS 36 - 44
Hohlmeißelzangen	<i>Bone Rongeurs</i>	BS 45 - 56
Knochensplitterzangen	<i>Bone Cutting Forceps</i>	BS 57 - 59
Instrumente für Fingernägel	<i>Nail Instruments</i>	BS 60
Sägen und Sägeblätter	<i>Saws and Saw Blades</i>	BS 61 - 62
Bohrapparate	<i>Hand Drills</i>	BS 63 - 65
Reibahlen	<i>Reamers</i>	BS 66
Bohrdrähte, Steinmann-Nägel	<i>Drill Wires, Steinmann Pins</i>	BS 67 - 69
Drahtspannzangen	<i>Wire Twisting Forceps</i>	BS 70 - 71
Drahtfasszangen	<i>Wire Holding Forceps</i>	BS 72
Flachzangen	<i>Flat Nose Pliers</i>	BS 73
Drahtschneidezangen	<i>Wire Cutting Pliers</i>	BS 74 - 76
Extensionsbügel	<i>Extension Bows</i>	BS 77
Cerclage-Instrumente	<i>Cerclage Instruments</i>	BS 78
Hämmer	<i>Mallets</i>	BS 79 - 84
Sehneninstrumente, Bleihand	<i>Tendon Instruments, Lead hand</i>	BS 85 - 87

Meißel und Osteotome Chisels and Osteotomes



Griff
Handle

RU 5301-00



5 mm

RU 5301-05



10 mm

RU 5301-10



16 mm

RU 5301-16



25 mm

RU 5301-25

Satz Meißel komplett, bestehend aus:
Chisel set complete, consisting of:

RU 5301-50

1 Griff (RU 5301-00)

1 Handle (RU 5301-00)

1 Meißelklinge, 10 mm (RU 5301-10)

1 Chisel blade, 10 mm (RU 5301-10)

1 Meißelklinge, 16 mm (RU 5301-16)

1 Chisel blade, 16 mm (RU 5301-16)

1 Meißelklinge, 25 mm (RU 5301-25)

1 Chisel blade, 25 mm (RU 5301-25)

1 Schlüssel (RU 5301-06)

1 Wrench (RU 5301-06)

Meißelklinge, 5 mm (RU 5301-05) optional

Chisel blade, 5 mm (RU 5301-05) optional



Schlüssel
Wrench

RU 5301-06



gerade
straight



gerade
straight

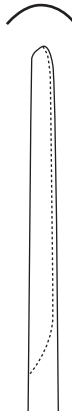

gerade
straight

	Osteotome Osteotomes	Flachmeißel Chisels	Hohlmeißel Gouges
	13,5 cm – 5¼"		
4 mm	RU 5300-04	RU 5302-04	RU 5304-04
6 mm	RU 5300-06	RU 5302-06	RU 5304-06
8 mm	RU 5300-08	RU 5302-08	RU 5304-08
10 mm	RU 5300-10	RU 5302-10	RU 5304-10
12 mm	RU 5300-12	RU 5302-12	RU 5304-12
14 mm	RU 5300-14	RU 5302-14	RU 5304-14
16 mm	RU 5300-16	RU 5302-16	RU 5304-16



LUCAS



gerade
straight



gerade
straight

	Flachmeißel Chisels	Hohlmeißel Gouges
	16 cm – 6¼"	
4 mm	RU 5305-34	RU 5305-44
6 mm	RU 5305-36	RU 5305-46

Meißel und Osteotome Chisels and Osteotomes



MODELL USA
USA PATTERN

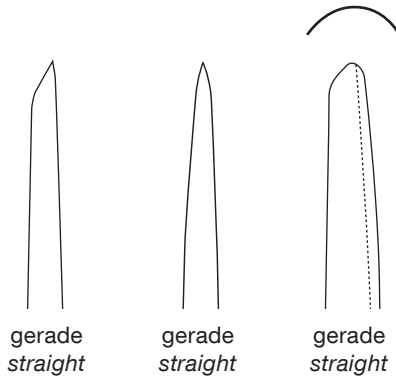

	Flachmeißel Chisels	Osteotome Osteotomes	Hohlmeißel Gouges
	16 cm – 6¼"		
6 mm	RU 5311-01	RU 5311-11	RU 5311-21
12 mm	RU 5311-02	RU 5311-12	RU 5311-22
18 mm	RU 5311-03	RU 5311-13	RU 5311-23



Stößel
Pestles



16 cm – 6¼"

RU 5317-03	RU 5317-05
-------------------	-------------------

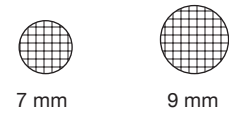

16 cm – 6¼"

RU 5317-07	RU 5317-09
-------------------	-------------------



ALEXANDER

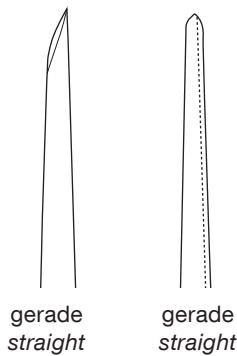

	Flachmeißel Chisels	Hohlmeißel Gouges
	18 cm – 7"	
4 mm	RU 5320-04	RU 5322-04
6 mm	RU 5320-06	RU 5322-06
8 mm	RU 5320-08	RU 5322-08
10 mm	RU 5320-10	RU 5322-10
12 mm	RU 5320-12	RU 5322-12
14 mm	RU 5320-14	RU 5322-14



HOKE

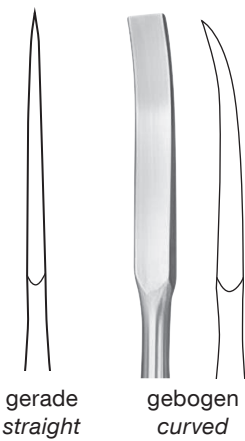

	Osteotome Osteotomes	Osteotome Osteotomes
	14 cm – 5½"	

2 mm	RU 5321-01	RU 5321-11
3 mm	RU 5321-02	RU 5321-12
4 mm	RU 5321-03	RU 5321-13
5 mm	RU 5321-04	RU 5321-14
6 mm	RU 5321-05	RU 5321-15
7 mm	RU 5321-06	RU 5321-16
8 mm	RU 5321-07	RU 5321-17



Osteotome mit Markierung
Osteotomes with depth marking

gerade
straight

18 cm – 7"

2 mm	RU 8253-02
4 mm	RU 8253-04
6 mm	RU 8253-06
7 mm	RU 8253-07
9 mm	RU 8253-09
12 mm	RU 8253-12

COTTLE

Flachmeißel mit Markierung
Chisels with depth marking

gerade
straight

18 cm – 7"

4 mm	RU 8258-04
6 mm	RU 8258-06
7 mm	RU 8258-07
9 mm	RU 8258-09
12 mm	RU 8258-12

COTTLE

SMITH-PETERSEN

gerade
straight

gebogen
curved

gerade
straight

gebogen
curved

	Osteotome Osteotomes		Hohlmeißel Gouges	
	20,5 cm – 8"			
6 mm	RU 5323-06	RU 5325-06	RU 5327-06	RU 5329-06
9 mm	RU 5323-09	RU 5325-09	RU 5327-09	RU 5329-09
13 mm	RU 5323-13	RU 5325-13	RU 5327-13	RU 5329-13
16 mm	RU 5323-16	RU 5325-16	RU 5327-16	RU 5329-16
19 mm	RU 5323-19	RU 5325-19	RU 5327-19	RU 5329-19
25 mm	RU 5323-25	RU 5325-25	RU 5327-25	RU 5329-25
32 mm	RU 5323-32	RU 5325-32	RU 5327-32	RU 5329-32

Meißel und Osteotome Chisels and Osteotomes



LAMBOTTE

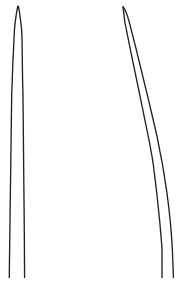

gerade
straight

gebogen
curved

	Osteotome Osteotomes	
	24,5 cm – 9¾"	
4 mm	RU 5330-04	RU 5331-04
6 mm	RU 5330-06	RU 5331-06
8 mm	RU 5330-08	RU 5331-08
10 mm	RU 5330-10	RU 5331-10
13 mm	RU 5330-13	RU 5331-13
16 mm	RU 5330-16	RU 5331-16
18 mm	RU 5330-18	RU 5331-18
20 mm	RU 5330-20	RU 5331-20
25 mm	RU 5330-25	RU 5331-25
30 mm	RU 5330-30	RU 5331-30
38 mm	RU 5330-38	RU 5331-38
44 mm	RU 5330-44	RU 5331-44
50 mm	RU 5330-50	RU 5331-50



MINI-LAMBOTTE



gerade
straight

	Osteotome Osteotomes	
	12,5 cm – 5"	17 cm – 6¾"
2 mm	RU 5332-02	RU 5333-02
3 mm	RU 5332-03	RU 5333-03
4 mm	RU 5332-04	RU 5333-04
6 mm	RU 5332-06	RU 5333-06
8 mm	RU 5332-08	RU 5333-08
10 mm	RU 5332-10	RU 5333-10
12 mm	RU 5332-12	RU 5333-12
15 mm	RU 5332-15	RU 5333-15

Meißel und Osteotome Chisels and Osteotomes



Instrumente mit **Propylux** Griffen

Ein hochstabiles Thermoplast mit wesentlich besseren Eigenschaften als das oft verwendete Ferrozell:

- Exzellente Resistenz gegen Säuren und Laugen, daher hygienisch unbedenklicher als Ferrozell
- Hohe Formstabilität auch nach Hunderten von Steri-Zyklen
- Hohe Festigkeit auch bei extremer Beanspruchung
- Hohe Farbbeständigkeit
- Enorme Reduzierung von Reparaturen
- Zugelassen bei der FDA
- Geeignet für alle Sterilisationsverfahren

Instruments with **Propylux** Handles

A highly resistant thermoplastic having much better characteristics than the often used Ferrozell:

- Excellent resistance against acids and leaches, therefore much safer than Ferrozell from the hygiene point of view
- High form stability even after hundreds of sterilisation cycles
- High solidity even when exposed to extreme loads
- Highly colour-fast
- Tremendously reduced need of repair
- FDA approved
- Suitable for all sterilisation procedures



LEXER



LEXER

gerade
straight

gerade
straight

	Osteotome Osteotomes	Hohlmeißel Gouges
	22 cm – 8¾"	
5 mm	RU 5336-05X	RU 5338-05X
7 mm	RU 5336-07X	RU 5338-07X
10 mm	RU 5336-10X	RU 5338-10X
15 mm	RU 5336-15X	RU 5338-15X
20 mm	RU 5336-20X	RU 5338-20X
25 mm	RU 5336-25X	RU 5338-25X
30 mm	RU 5336-30X	RU 5338-30X
40 mm	RU 5336-40X	RU 5338-40X

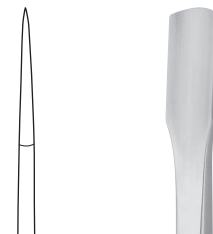

MINI-LEXER

gerade
straight

gerade
straight

	Osteotome Osteotomes	Hohlmeißel Gouges
	18 cm – 7"	
4 mm	RU 5334-04X	RU 5335-04X
6 mm	RU 5334-06X	RU 5335-06X
8 mm	RU 5334-08X	RU 5335-08X
10 mm	RU 5334-10X	RU 5335-10X
12 mm	RU 5334-12X	RU 5335-12X

Meißel und Osteotome

Chisels and Osteotomes



STILLE

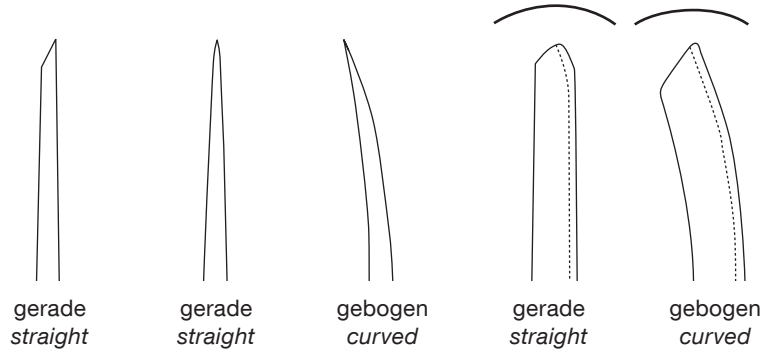

	Flachmeißel Chisels	Osteotome Osteotomes		Hohlmeißel Gouges	
	20 cm – 8"				
6 mm	RU 5340-06	RU 5341-06	RU 5341-56	RU 5342-06	RU 5342-56
8 mm	RU 5340-08	RU 5341-08	RU 5341-58	RU 5342-08	RU 5342-58
10 mm	RU 5340-10	RU 5341-10	RU 5341-60	RU 5342-10	RU 5342-60
12 mm	RU 5340-12	RU 5341-12	RU 5341-62	RU 5342-12	RU 5342-62
15 mm	RU 5340-15	RU 5341-15	RU 5341-65	RU 5342-15	RU 5342-65
20 mm	RU 5340-20	RU 5341-20	RU 5341-70	RU 5342-20	RU 5342-70
25 mm	RU 5340-25	RU 5341-25	RU 5341-75	RU 5342-25	RU 5342-75
30 mm	RU 5340-30	RU 5341-30	RU 5341-80	RU 5342-30	RU 5342-80



HIBBS

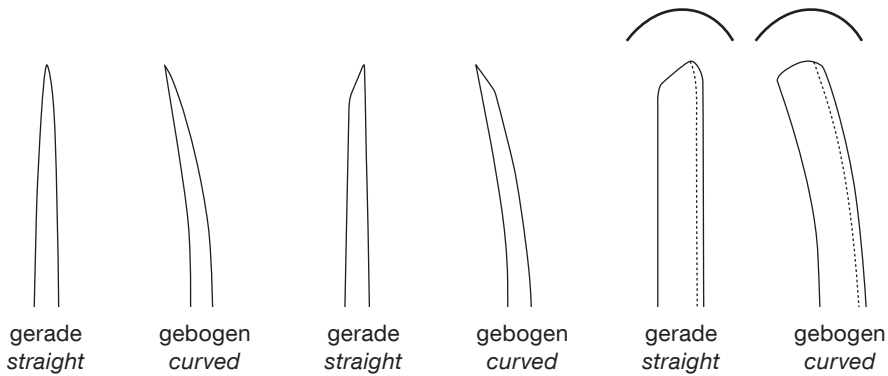

	Osteotome Osteotomes		Flachmeißel Chisels		Hohlmeißel Gouges	
	24 cm – 9½"		24 cm – 9½"		24 cm – 9½"	
6 mm	RU 5344-06	RU 5344-56	RU 5345-06	RU 5345-56	RU 5346-06	RU 5346-56
9 mm	RU 5344-09	RU 5344-59	RU 5345-09	RU 5345-59	RU 5346-09	RU 5346-59
13 mm	RU 5344-13	RU 5344-63	RU 5345-13	RU 5345-63	RU 5346-13	RU 5346-63
16 mm	RU 5344-16	RU 5344-66	RU 5345-16	RU 5345-66	RU 5346-16	RU 5346-66
19 mm	RU 5344-19	RU 5344-69	RU 5345-19	RU 5345-69	RU 5346-19	RU 5346-69
22 mm	RU 5344-22	RU 5344-72	RU 5345-22	RU 5345-72	RU 5346-22	RU 5346-72
25 mm	RU 5344-25	RU 5344-75	RU 5345-25	RU 5345-75	RU 5346-25	RU 5346-75
28 mm	RU 5344-28	RU 5344-78	RU 5345-28	RU 5345-78	RU 5346-28	RU 5346-78
32 mm	RU 5344-32	RU 5344-82	RU 5345-32	RU 5345-82	RU 5346-32	RU 5346-82
38 mm	RU 5344-38	RU 5344-88	RU 5345-38	RU 5345-88	RU 5346-38	RU 5346-88

Meißel und Osteotome

Chisels and Osteotomes



Instrumente mit **Propylux** Griffen

Ein hochstabiles Thermoplast mit wesentlich besseren Eigenschaften als das oft verwendete Ferrozell:

- Exzellente Resistenz gegen Säuren und Laugen, daher hygienisch unbedenklicher als Ferrozell
- Hohe Formstabilität auch nach Hunderten von Steri-Zyklen
- Hohe Festigkeit auch bei extremer Beanspruchung
- Hohe Farbbeständigkeit
- Enorme Reduzierung von Reparaturen
- Zugelassen bei der FDA
- Geeignet für alle Sterilisationsverfahren

Instruments with **Propylux** Handles

A highly resistant thermoplastic having much better characteristics than the often used Ferrozell:

- Excellent resistance against acids and leaches, therefore much safer than Ferrozell from the hygiene point of view
- High form stability even after hundreds of sterilisation cycles
- High solidity even when exposed to extreme loads
- Highly colour-fast
- Tremendously reduced need of repair
- FDA approved
- Suitable for all sterilisation procedures

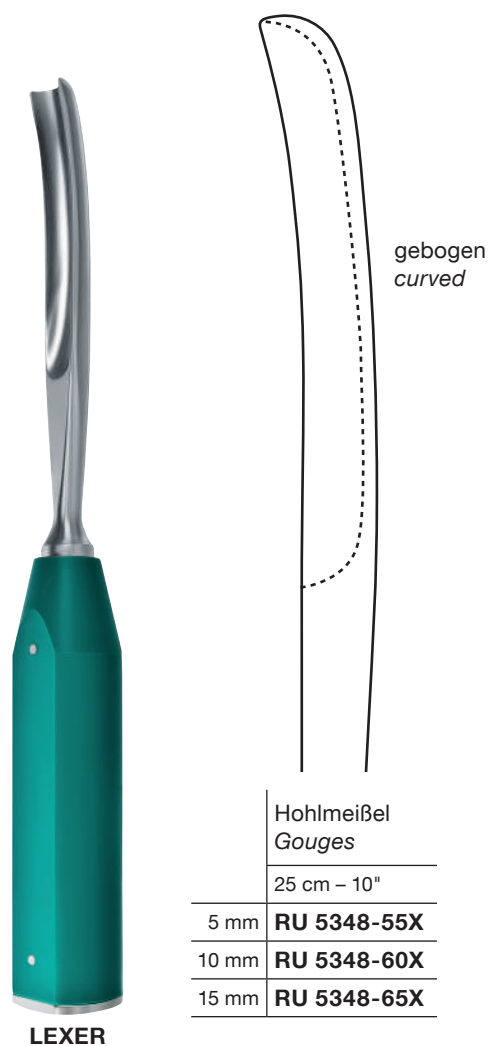
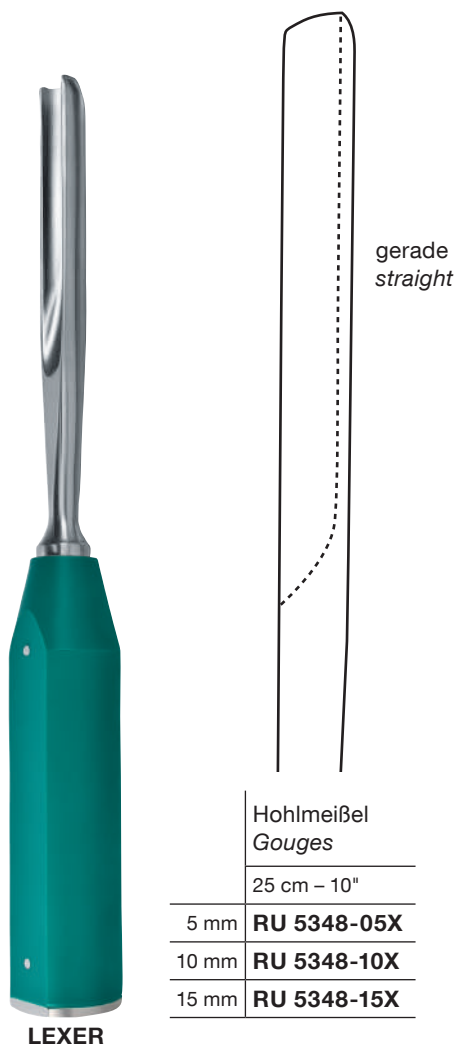



COBB

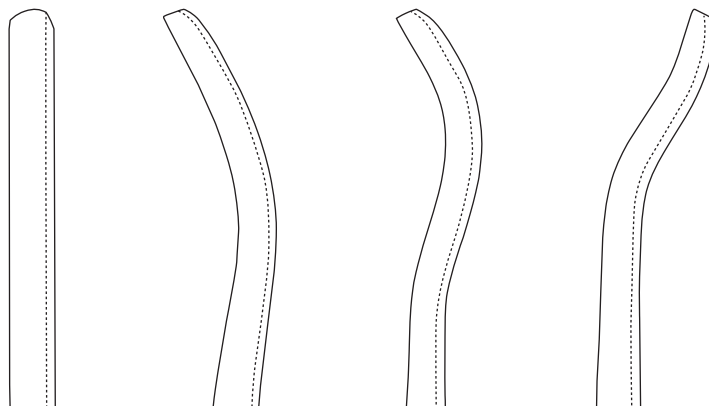

Hohlmeißel
Gouges

27,5 cm – 10 3/4"

RU 5349-01	RU 5349-02	RU 5349-03	RU 5349-04
------------	------------	------------	------------



Fig. 0000 – 2,5 mm



RU 5350-40

Fig. 000 – 3,6 mm



RU 5350-30

Fig. 00 – 4,4 mm



RU 5350-20

Fig. 0 – 5,2 mm



RU 5350-10

Fig. 1 – 6,8 mm



RU 5350-01

Fig. 2 – 8,5 mm



RU 5350-02

Fig. 3 – 10 mm



RU 5350-03

Fig. 4 – 11,5 mm

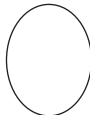

RU 5350-04

Fig. 5 – 13 mm

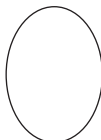

RU 5350-05

Fig. 6 – 14,5 mm

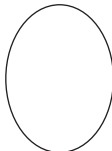

RU 5350-06



VOLKMANN

17 cm – 6¾"



BRUNS

23 cm – 9"

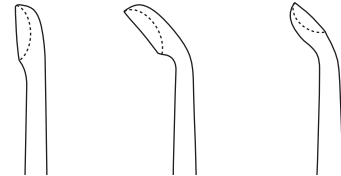

Fig. 000 – 3,3 mm



RU 5351-08

RU 5351-58

RU 5351-78

Fig. 00 – 3,9 mm



RU 5351-09

RU 5351-59

RU 5351-79

Fig. 0 – 4,7 mm



RU 5351-10

RU 5351-60

RU 5351-80

Fig. 1 – 5,3 mm



RU 5351-11

RU 5351-61

RU 5351-81

Fig. 2 – 6 mm



RU 5351-12

RU 5351-62

RU 5351-82

Fig. 3 – 7,2 mm



RU 5351-13

RU 5351-63

RU 5351-83

Fig. 4 – 8,2 mm



RU 5351-14

RU 5351-64

RU 5351-84

Fig. 5 – 9,8 mm



RU 5351-15

RU 5351-65

RU 5351-85

Fig. 6 – 12 mm



RU 5351-16

RU 5351-66

RU 5351-86

Scharfe Löffel Bone Curettes



Fig. 000 – 3,3 mm

○ **RU 5352-30**

Fig. 00 – 4,8 mm

○ **RU 5352-20**

Fig. 0 – 5,8 mm

○ **RU 5352-10**

Fig. 1 – 7,3 mm

○ **RU 5352-01**

Fig. 2 – 8,3 mm

○ **RU 5352-02**

Fig. 3 – 10,2 mm

○ **RU 5352-03**

Fig. 4 – 11,8 mm

○ **RU 5352-04**

Fig. 5 – 12,8 mm

○ **RU 5352-05**

Fig. 6 – 14 mm

○ **RU 5352-06**



BRUNS

17 cm – 6¾"



Fig. 0000 – 2,5 mm

○ **RU 5353-40**

Fig. 000 – 2,8 mm

○ **RU 5353-30**

Fig. 00 – 3,3 mm

○ **RU 5353-20**

Fig. 0 – 3,7 mm

○ **RU 5353-10**

Fig. 1 – 4,3 mm

○ **RU 5353-01**

Fig. 2 – 4,8 mm

○ **RU 5353-02**

Fig. 3 – 5,6 mm

○ **RU 5353-03**

Fig. 4 – 6,1 mm

○ **RU 5353-04**

Fig. 5 – 6,7 mm

○ **RU 5353-05**

Fig. 6 – 8,8 mm

○ **RU 5353-06**



SPRATT

17 cm – 6¾"

Scharfe Löffel Bone Curettes



2 mm

17 cm – 6¾"

○ **RU 5354-22**



2 mm

17 cm – 6¾"

○ **RU 5354-42**

3 mm

17 cm – 6¾"

○ **RU 5354-23**

3 mm

17 cm – 6¾"

○ **RU 5354-43**

4 mm

17 cm – 6¾"

○ **RU 5354-24**

4 mm

17 cm – 6¾"

○ **RU 5354-44**

5 mm

19,5 cm – 7¾"

○ **RU 5354-25**

5 mm

19,5 cm – 7¾"

○ **RU 5354-45**

6 mm

19,5 cm – 7¾"

○ **RU 5354-26**

6 mm

19,5 cm – 7¾"

○ **RU 5354-46**

7 mm

19,5 cm – 7¾"

○ **RU 5354-27**

7 mm

19,5 cm – 7¾"

○ **RU 5354-47**

8 mm

20 cm – 8"

○ **RU 5354-28**

8 mm

20 cm – 8"

○ **RU 5354-48**

10 mm

20,5 cm – 8"

○ **RU 5354-30**

10 mm

21 cm – 8¼"

○ **RU 5354-50**

12 mm

20,5 cm – 8"

○ **RU 5354-32**

12 mm

21,5 cm – 8½"

○ **RU 5354-52**

14 mm

20,5 cm – 8"

○ **RU 5354-34**

14 mm

22 cm – 8¾"

○ **RU 5354-54**



Fig. 000 – 3 mm

○ **RU 5355-30**

Fig. 00 – 4 mm

○ **RU 5355-20**

Fig. 0 – 5 mm

○ **RU 5355-10**

Fig. 1 – 6 mm

○ **RU 5355-01**

Fig. 2 – 7 mm

○ **RU 5355-02**

Fig. 3 – 8 mm

○ **RU 5355-03**

Fig. 4 – 9 mm

○ **RU 5355-04**



schwedisches
Modell
swedish
pattern







SCHEDE

17 cm – 6¾"

Scharfe Löffel Bone Curettes



WILLIGER
17,5 cm – 7"





-  Fig. 00 – 2,5 mm
RU 5356-20
-  Fig. 0 – 3,2 mm
RU 5356-10
-  Fig. 1 – 4 mm
RU 5356-01
-  Fig. 2 – 5,7 mm
RU 5356-02

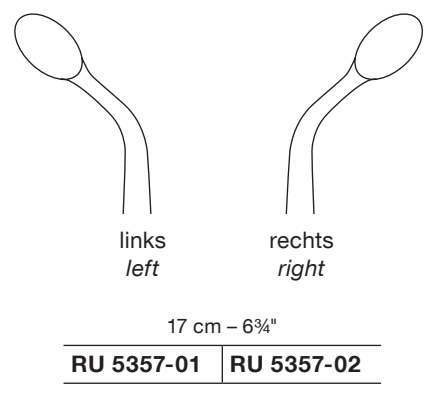

UFFENRODE



VOLKMANN
28 cm – 11"

-  Fig. 0 – 4,4 mm
RU 5358-10
-  Fig. 1 – 6,8 mm
RU 5358-01
-  Fig. 2 – 8,5 mm
RU 5358-02
-  Fig. 3 – 10 mm
RU 5358-03



DAUBENSPECK
20 cm – 8"

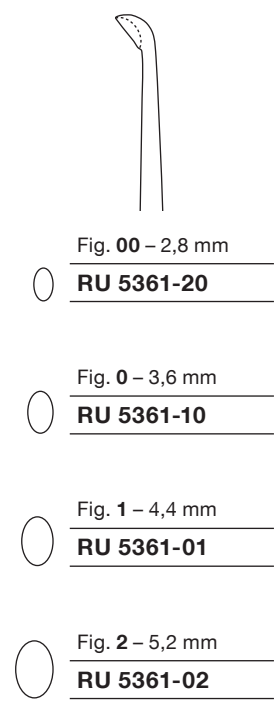



19 cm – 7½"



gerade, keramikbeschichtet
straight, ceramic coated

19 cm – 7½"

Fig. 000

RU 5363-101



19 cm – 7½"

Fig. 0

RU 5363-103



gebogen, keramikbeschichtet
curved, ceramic coated

19 cm – 7½"

Fig. 000

RU 5363-111



19 cm – 7½"

Fig. 0

RU 5363-113



rückwärts gebogen, keramikbeschichtet
reverse curved, ceramic coated

19 cm – 7½"

Fig. 000

RU 5363-301



19 cm – 7½"

Fig. 0

RU 5363-303



Scharfe Löffel Bone Curettes



biegsam
malleable

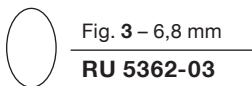
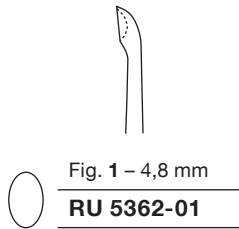

HALLE

21 cm – 8¼"

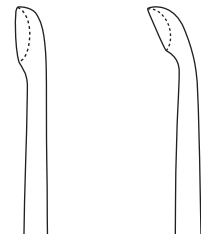

Fig. 000 – 3,6 mm

25 cm – 10"

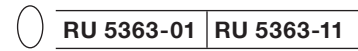

Fig. 00 – 4,4 mm

25 cm – 10"

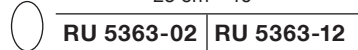

Fig. 0 – 5,2 mm

25 cm – 10"

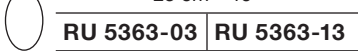
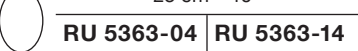

Fig. 1 – 6 mm

25 cm – 10"



1:3



VOLKMANN

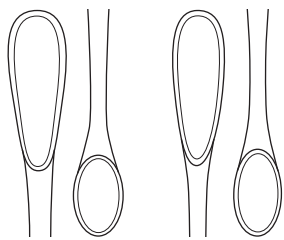

13 cm – 5"

14,5 cm – 5¾"

RU 5364-13 | **RU 5364-14**

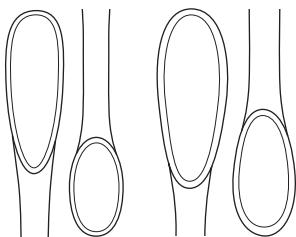

17 cm – 6¾"

20 cm – 8"

RU 5364-17 | **RU 5364-20**



VOLKMANN

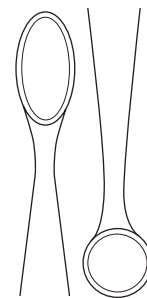

13 cm – 5"

RU 5365-13

16 cm – 6¼"

RU 5365-16

20 cm – 8"

RU 5365-20



Ø 3,1 / 2,6 mm

RU 5366-00

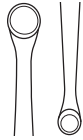

Ø 4,2 / 3,1 mm

RU 5366-01



Ø 4,8 / 4,2 mm

RU 5366-12

MARTINI

13,5 cm – 5¼"



Ø 3 / 2,5 mm

RU 5368-00



Ø 3,5 / 3 mm

RU 5368-01



Ø 4,2 / 3,5 mm

RU 5368-12

WILLIGER

13,5 cm – 5¼"

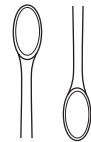

Ø 4 / 3,5 mm

RU 5369-13

JACOBSON

13 cm – 5"



Ø 4,5 / 3,5 mm

RU 7921-15

JANSEN

15 cm – 6"

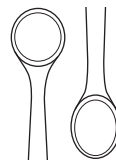

Ø 6,5 / 6,2 mm

RU 5370-21

WILLIGER

20,5 cm – 8"

Knochenraspeln Bone Rasps

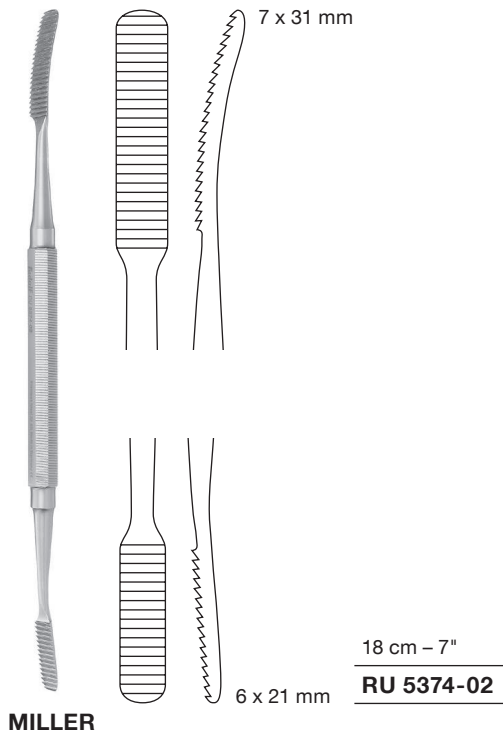



scharf
sharp

19 cm – 7½"

RU 5379-19

MOLT



12,5 mm



gerade
straight



gebogen
curved

15 cm – 6"

RU 5380-15

RU 5381-15

FARABEUF



18 mm

scharf
sharp

18,5 cm – 7¼"

RU 5382-18

SEDILLOT



15 mm

scharf
sharp

21,5 cm – 8½"

RU 5382-21

SEDILLOT



LANGENBECK



scharf,
leicht gebogen
*sharp,
slightly curved*

19 cm – 7½"

RU 5384-18



CUSHING

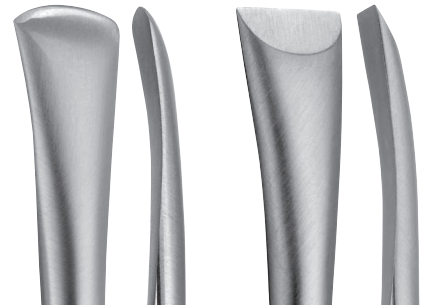

rund, scharf,
leicht gebogen
*round, sharp,
slightly curved*

eckig, scharf,
leicht gebogen
*square, sharp,
slightly curved*

18 cm – 7"

RU 5384-30

RU 5384-31



LAMBOTTE



scharf,
leicht gebogen
*sharp,
slightly curved*

21,5 cm – 8½"

5 mm	RU 5385-05
10 mm	RU 5385-10
15 mm	RU 5385-15
20 mm	RU 5385-20
25 mm	RU 5385-25



SCHNEIDER-SAUERBRUCH



scharf, gebogen
sharp, curved

19 cm – 7½"

RU 5386-19

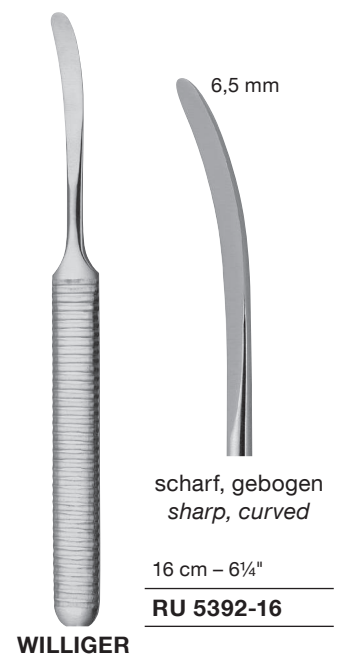
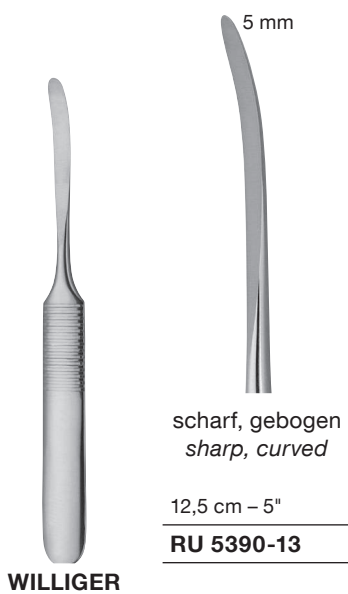
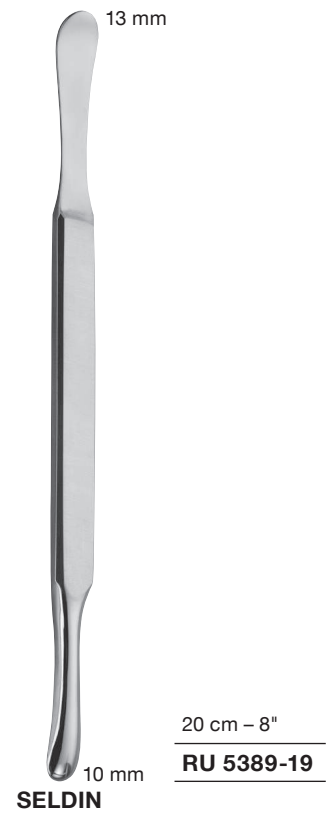
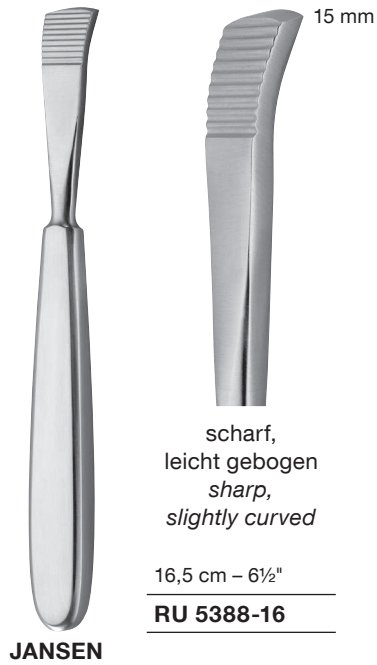
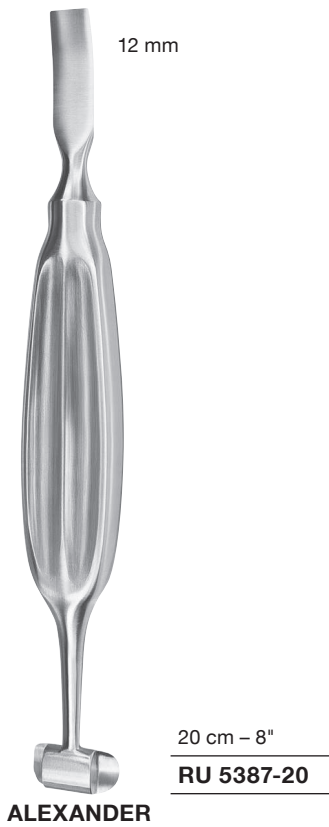

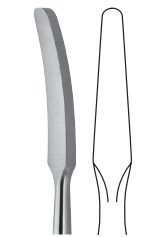

scharf,
leicht gebogen
sharp,
slightly curved

16,5 cm – 6½"

RU 8206-16

JOSEPH



scharf,
leicht gebogen
sharp,
slightly curved

19,5 cm – 7¾"

RU 8210-19

COTTLE



scharf
sharp



scharf
sharp

17 cm – 6¾"

RU 5393-01

RU 5393-03



stumpf
blunt



scharf
sharp

17 cm – 6¾"

RU 5393-02

RU 5393-04

ADSON



scharf, gebogen
sharp, curved

17 cm – 6¾"

6 mm

RU 5394-06

8 mm

RU 5394-08



SEMB

	12 mm	12 mm	12 mm	13 mm	13 mm	15 mm	15 mm
19,5 cm – 7¾"	21 cm – 8¼"	18 cm – 7"	20 cm – 8"	21,5 cm – 8½"	22 cm – 8¾"	22 cm – 8¾"	
RU 5398-01	RU 5398-02	RU 5398-03	RU 5398-04	RU 5398-05	RU 5398-06	RU 5398-07	



DOYEN

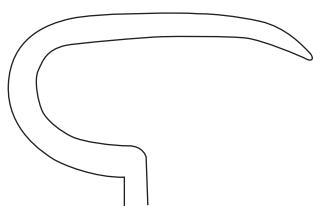

17 cm – 6¾"
RU 5400-01

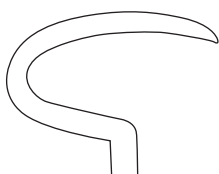

17 cm – 6¾"
RU 5402-01



DOYEN

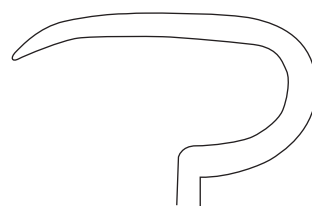

17 cm – 6¾"
RU 5400-02

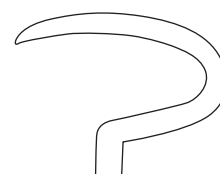

17 cm – 6¾"
RU 5402-02



SYME

18 cm – 7"
RU 5407-01

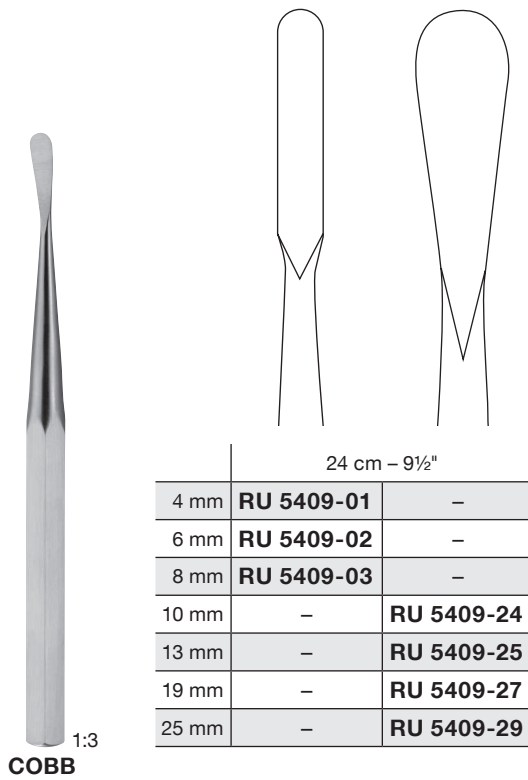

Instrumente mit **Propylux** Griffen

Ein hochstabiles Thermoplast mit wesentlich besseren Eigenschaften als das oft verwendete Ferrozell:

- Exzellente Resistenz gegen Säuren und Laugen, daher hygienisch unbedenklicher als Ferrozell
- Hohe Formstabilität auch nach Hunderten von Steri-Zyklen
- Hohe Festigkeit auch bei extremer Beanspruchung
- Hohe Farbbeständigkeit
- Enorme Reduzierung von Reparaturen
- Zugelassen bei der FDA
- Geeignet für alle Sterilisationsverfahren

Instruments with **Propylux** Handles

A highly resistant thermoplastic having much better characteristics than the often used Ferrozell:

- Excellent resistance against acids and leaches, therefore much safer than Ferrozell from the hygiene point of view
- High form stability even after hundreds of sterilisation cycles
- High solidity even when exposed to extreme loads
- Highly colour-fast
- Tremendously reduced need of repair
- FDA approved
- Suitable for all sterilisation procedures

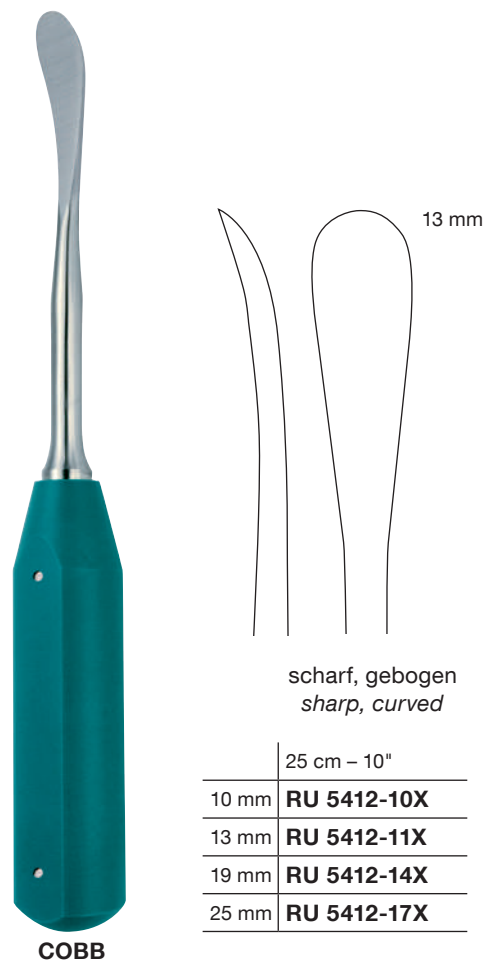
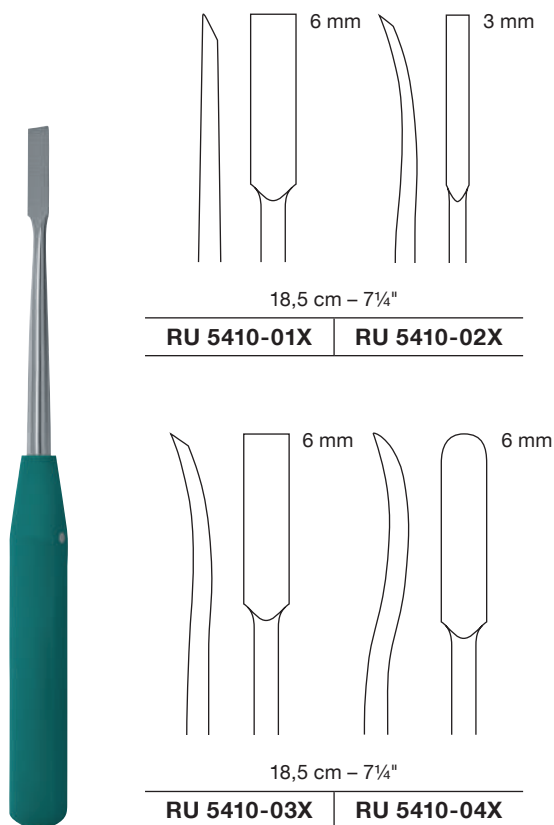

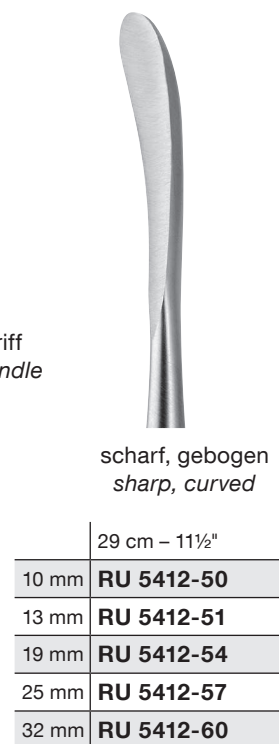
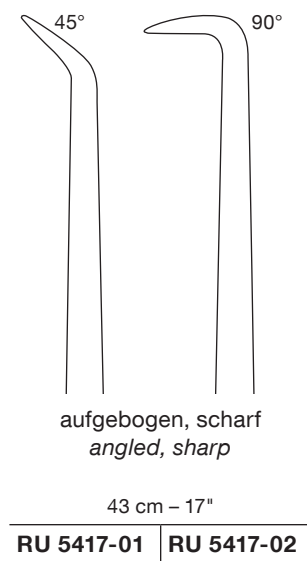
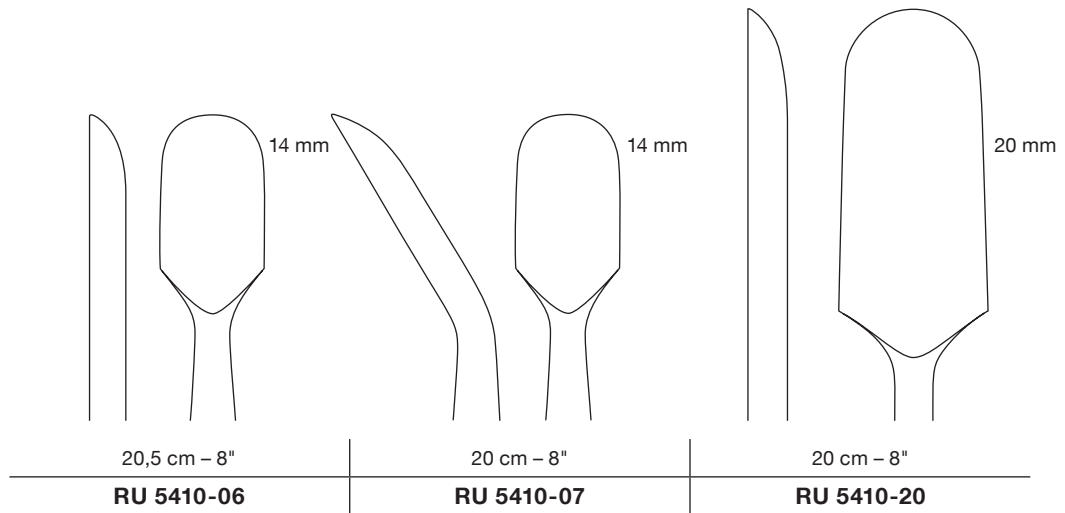

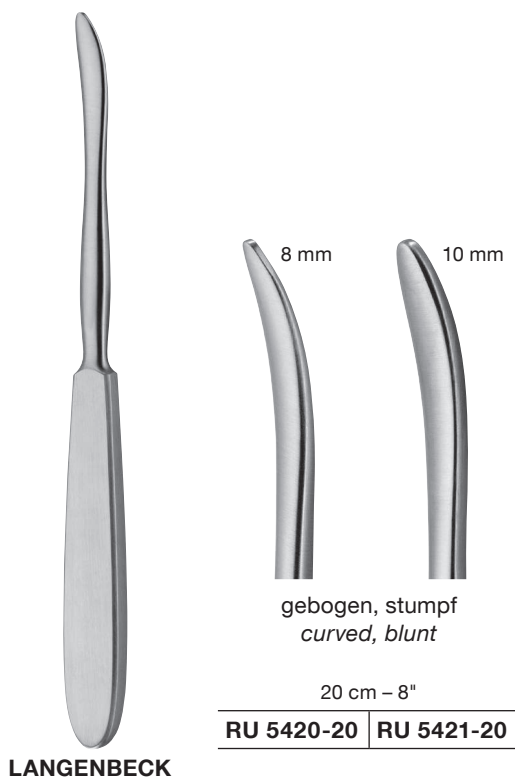
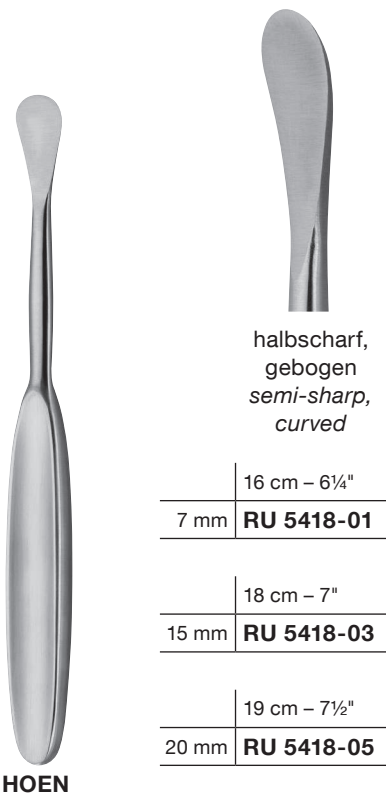



15 cm – 6"

RU 5423-15



gebogen,
stumpf
*curved,
blunt*

17 cm – 6¾"

RU 5425-17

WILLIGER



gebogen,
stumpf
*curved,
blunt*

16 cm – 6¼"

RU 5426-16

WILLIGER



19,5 cm – 7¾"

RU 5427-20

QUERVAIN



KEY



scharf
sharp

17,5 cm – 7"	3 mm	RU 5430-03
18 cm – 7"	6 mm	RU 5430-06
19 cm – 7½"	10 mm	RU 5430-10
	13 mm	RU 5430-12
20 cm – 8"	16 mm	RU 5430-16
	19 mm	RU 5430-19
	25 mm	RU 5430-25

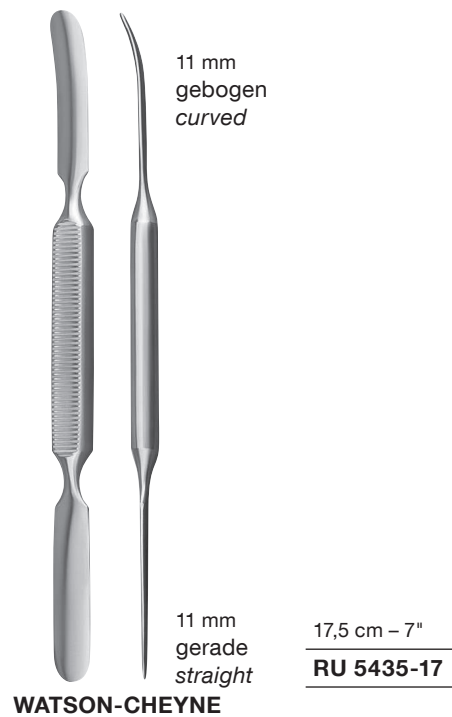
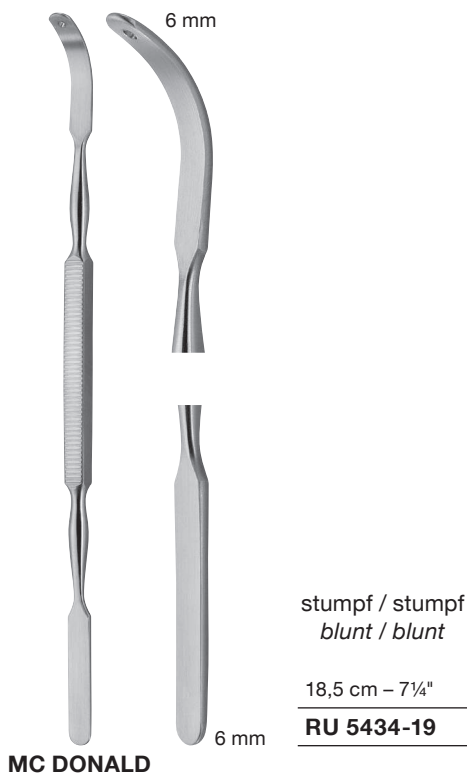
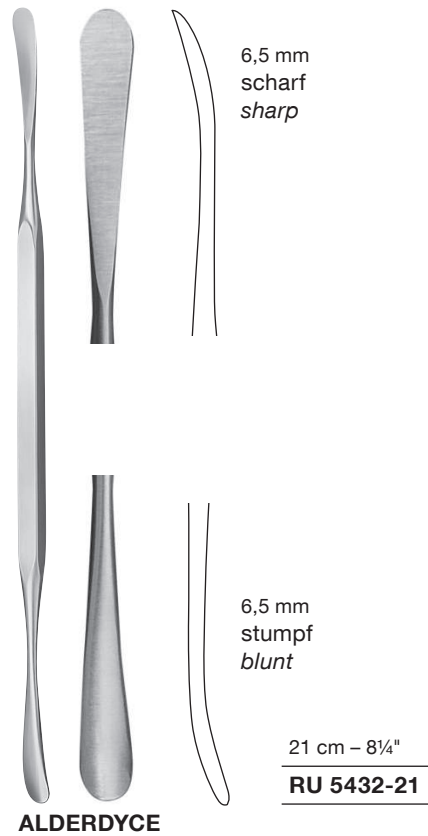
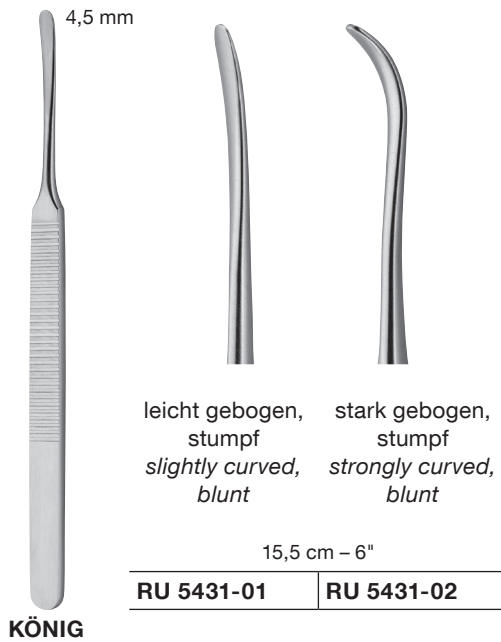

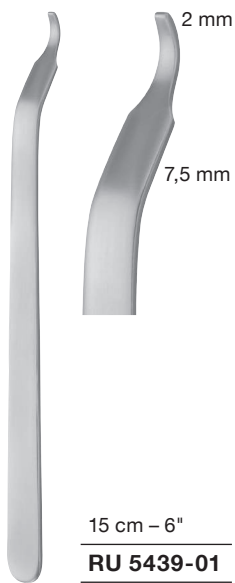

BUCK-GRAMCKO



MINI-HOHMANN



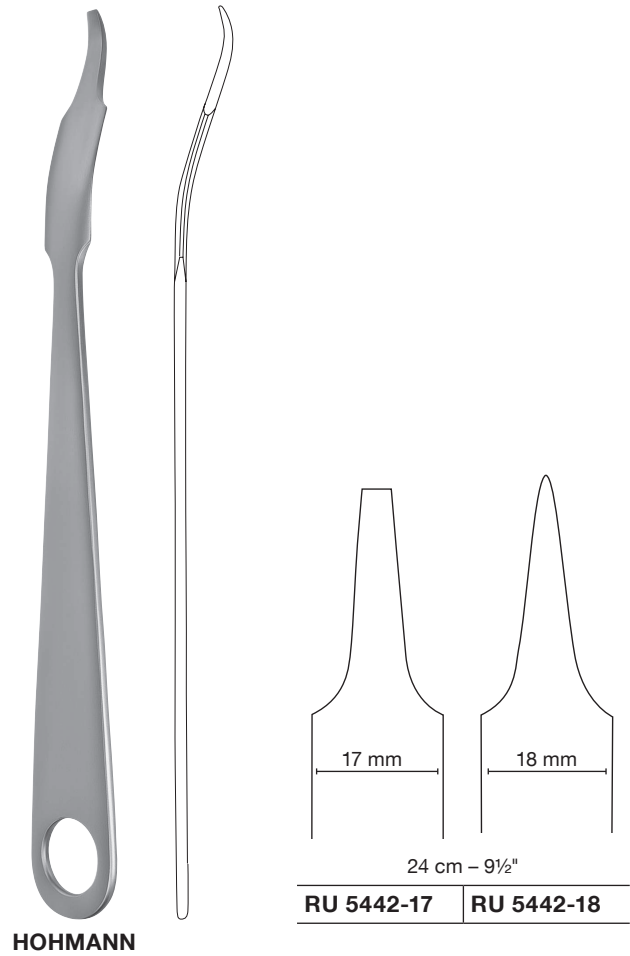



HOHMANN

1:3
24,5 cm – 9¾"
RU 5442-50



HOHMANN

1:3
24 cm – 9½"
RU 5442-65



HOHMANN-ALDINGER

1:3
27 cm – 10½"
RU 5444-01



VERBRUGGE-MÜLLER

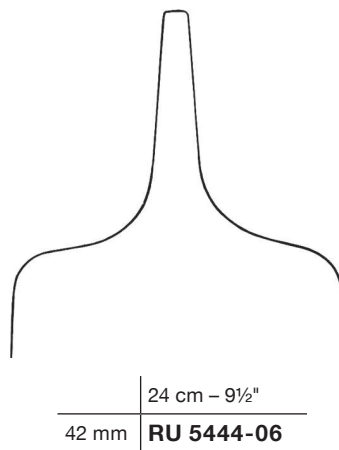

42 mm | 24 cm – 9½"
RU 5444-06



LANE-TRETHOWAN

21,5 cm – 8½"
RU 5444-10



BRISTOW

1:3

23 cm – 9"
RU 5444-12



MURPHY-LANE

1:3

32 cm – 12½"
RU 5445-32



BLOUNT

1:3

38 mm

26 cm – 10¼"
RU 5447-01



BLOUNT

1:3

42 mm

26 cm – 10¼"
RU 5447-02



BENNETT

1:3

	24 cm – 9½"
44 mm	RU 5450-44
60 mm	RU 5450-64



VOLKMANN

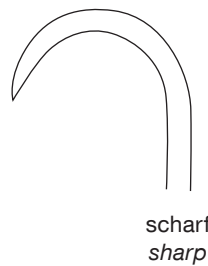

scharf
sharp

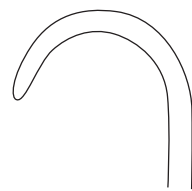

stumpf
blunt

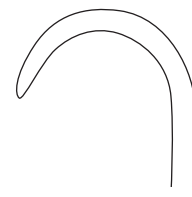

halbscharf
semi-sharp

22 cm – 8¾"

RU 4500-01	RU 4501-01	RU 4503-01
-------------------	-------------------	-------------------



VOLKMANN

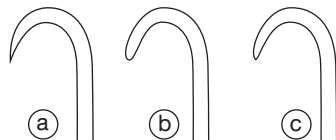

- Ⓐ scharf / sharp
- Ⓑ stumpf / blunt
- Ⓒ halbscharf / semi-sharp

9 x 8 mm



9 x 13 mm



9 x 19 mm



22 cm – 8¾"

	RU 4500-02	RU 4500-03	RU 4500-04
	RU 4501-02	RU 4501-03	RU 4501-04
	RU 4502-02	RU 4502-03	RU 4502-04

9 x 29 mm



9 x 40 mm

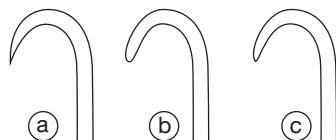

- Ⓐ scharf / sharp
- Ⓑ stumpf / blunt
- Ⓒ halbscharf / semi-sharp

22 cm – 8¾"

	RU 4500-06	RU 4500-08
	RU 4501-06	RU 4501-08
	RU 4502-06	RU 4502-08

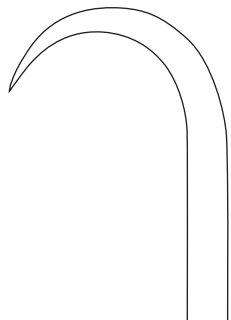

scharf
sharp

24 cm – 9½"

RU 4506-24



KOCHER

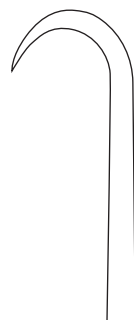

scharf
sharp

21,5 cm – 8½"

RU 4506-01



KOCHER

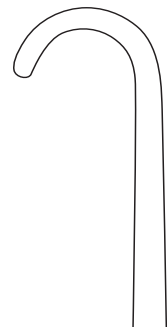

stumpf
blunt

21,5 cm – 8½"

RU 4507-01



KOCHER

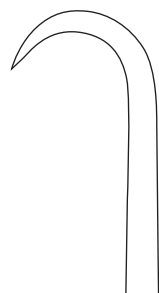

scharf
sharp

21,5 cm – 8½"

RU 4506-11



KOCHER

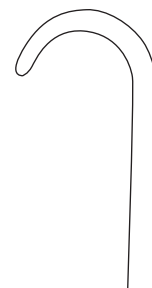

stumpf
blunt

21,5 cm – 8½"

RU 4507-11

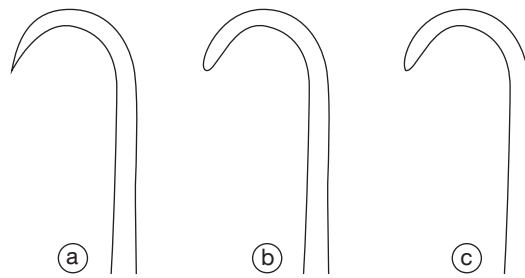

15 x 10 mm

15 x 15 mm

20 x 18 mm



22,5 cm – 8¾"

(a)	scharf <i>sharp</i>	RU 4506-02	RU 4506-03	RU 4506-04
(b)	stumpf <i>blunt</i>	RU 4507-02	RU 4507-03	RU 4507-04
(c)	halbscharf <i>semi-sharp</i>	RU 4508-02	RU 4508-03	RU 4508-04



KOCHER

15 x 30 mm

15 x 40 mm



22,5 cm – 8¾"

(a)	scharf <i>sharp</i>	RU 4506-06	RU 4506-08
(b)	stumpf <i>blunt</i>	RU 4507-06	RU 4507-08
(c)	halbscharf <i>semi-sharp</i>	RU 4508-06	RU 4508-08

Spinalhaken, Meniskusmesser
 Spinal Retractors, Meniscus Knives

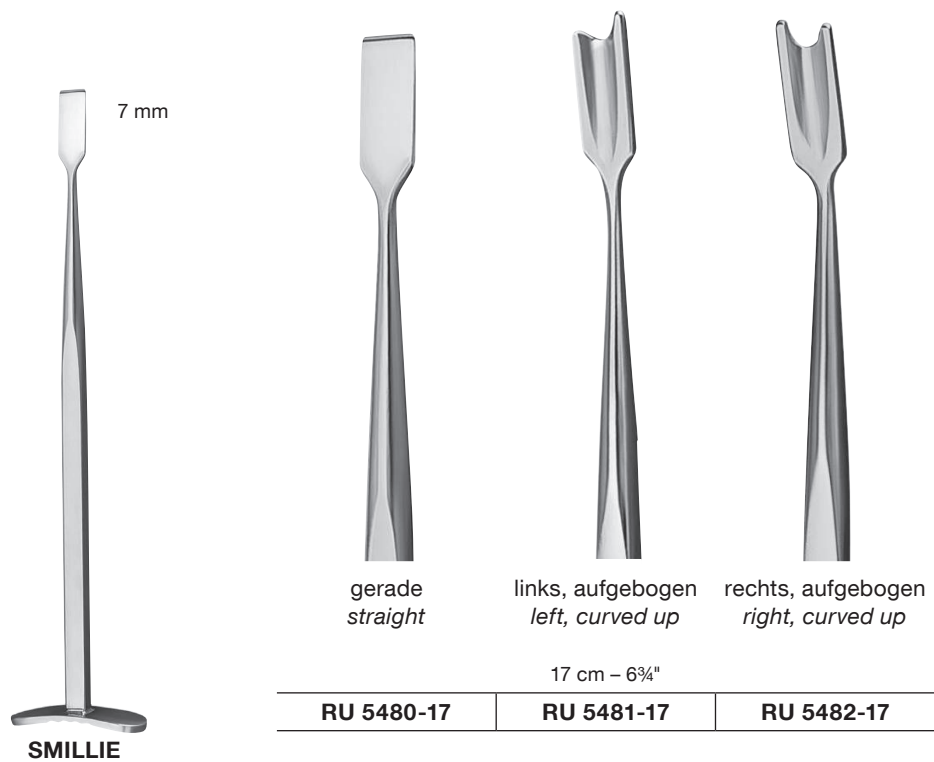
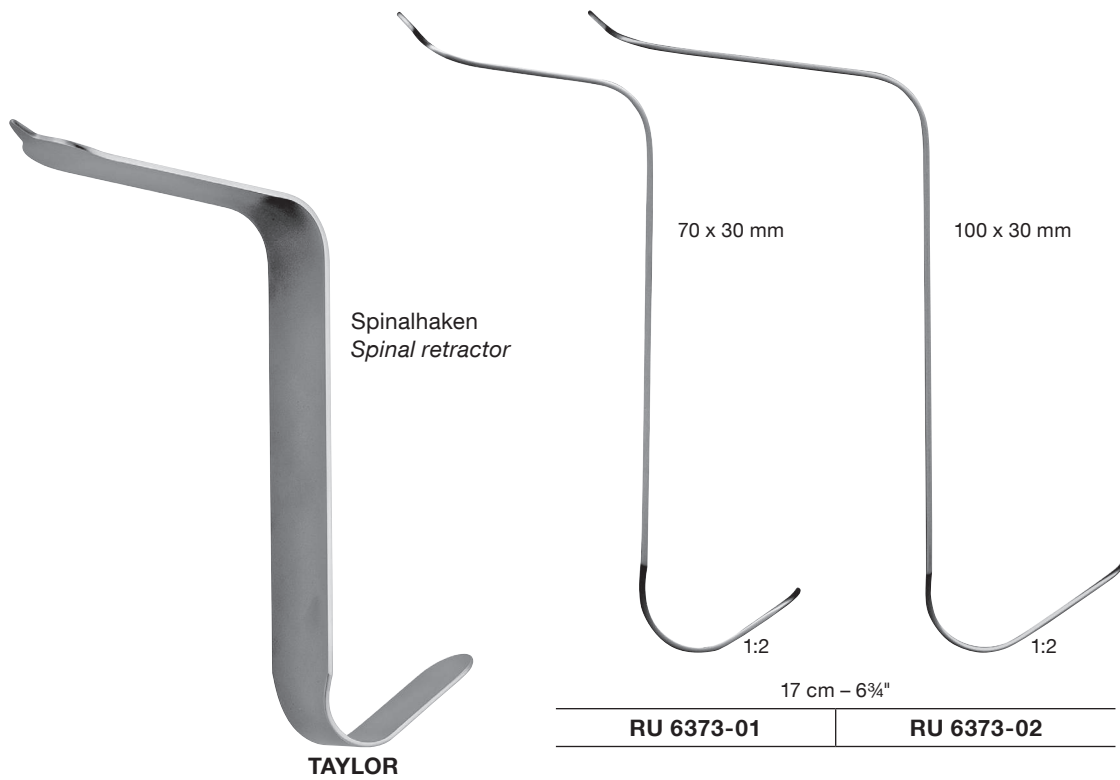

Knochenhaltezangen Bone Holding Forceps

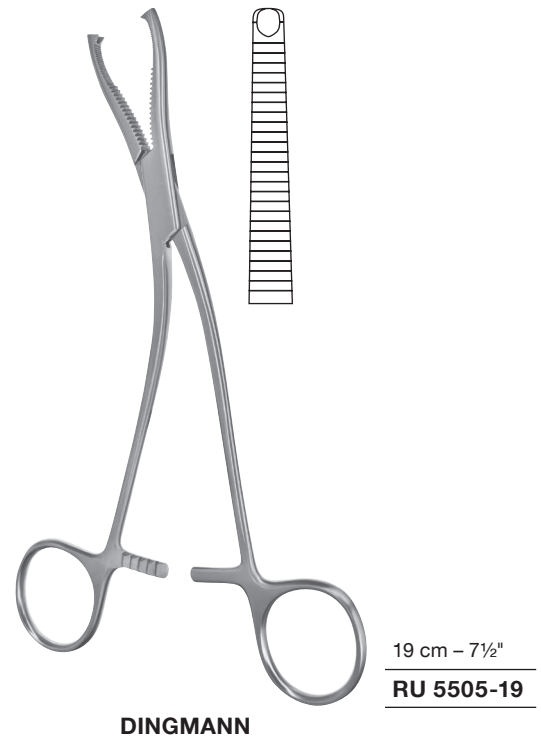
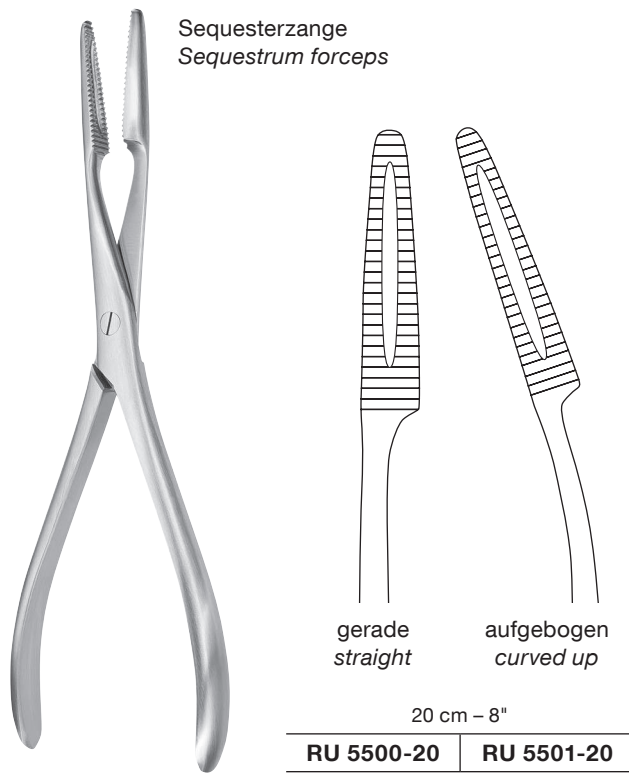

Knochenhaltezangen
Bone Holding Forceps

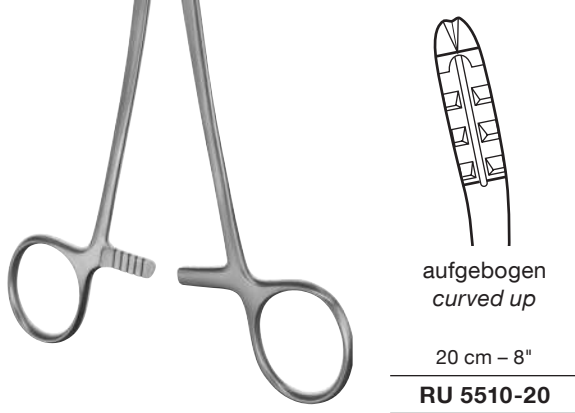
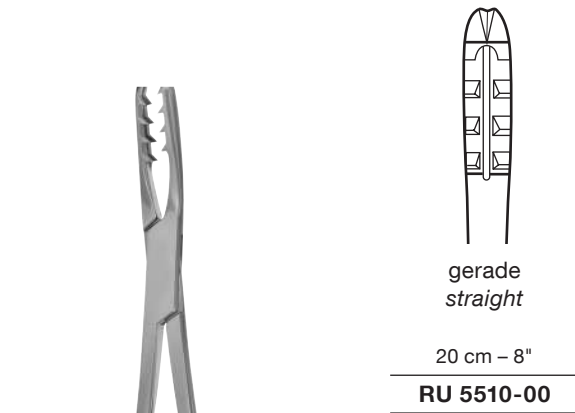

BIRCHER-GANSKE

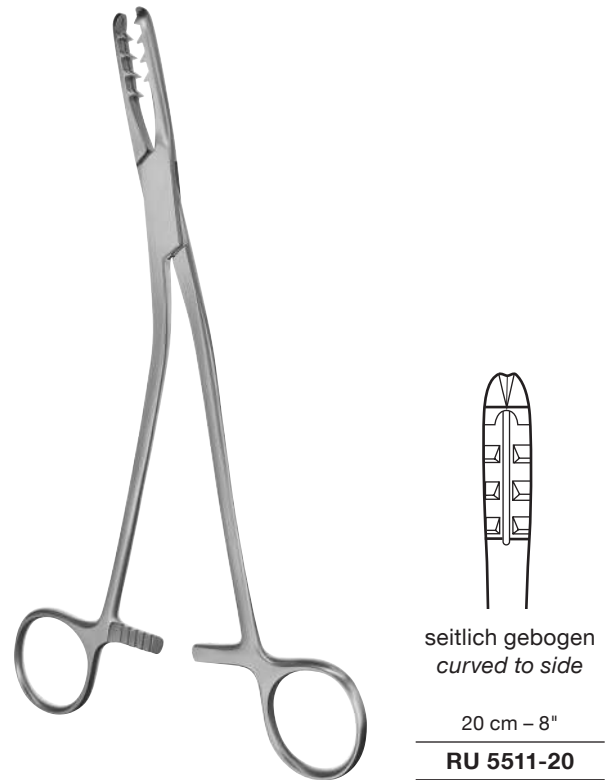

BIRCHER-GANSKE



LEWIN

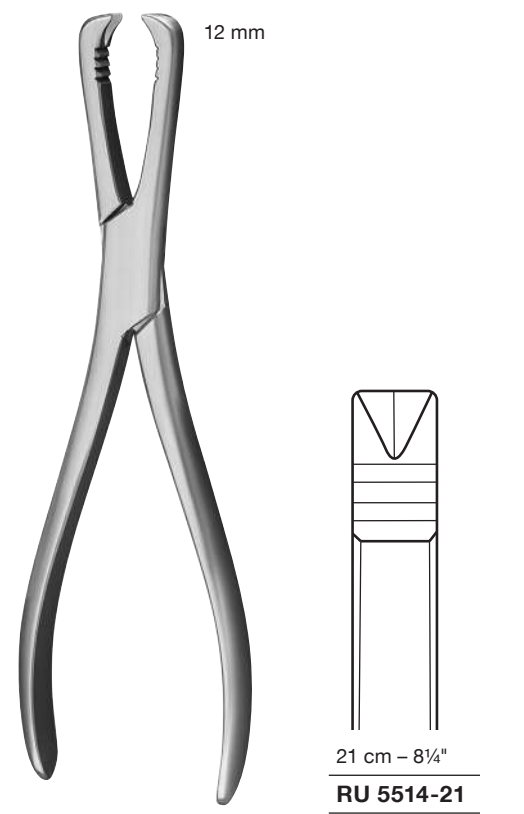

LANGENBECK

Knochenhaltezangen Bone Holding Forceps



11 mm



21 cm – 8¼"

RU 5516-21

FERGUSSON

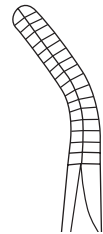

16 cm – 6¼"

RU 5518-16

24 cm – 9½"

RU 5518-24



KERN



ohne Sperre
without ratchet

mit Sperre
with ratchet

17 cm – 6¾"

RU 5520-17

RU 5521-17

21 cm – 8¼"

RU 5520-21

RU 5521-21

Knochenhaltezangen Bone Holding Forceps



18 cm – 7"	RU 5522-18
23 cm – 9"	RU 5522-23
25 cm – 10"	RU 5522-25
28 cm – 11"	RU 5522-28



21 cm – 8¼"	RU 5524-21
27 cm – 10½"	RU 5524-27
30,5 cm – 12"	RU 5524-30

HEY GROVES



SEMB

19 cm – 7½"	RU 5525-19
-------------	-------------------



SEMB

19 cm – 7½"	RU 5525-51
-------------	-------------------

Knochenhaltezangen Bone Holding Forceps

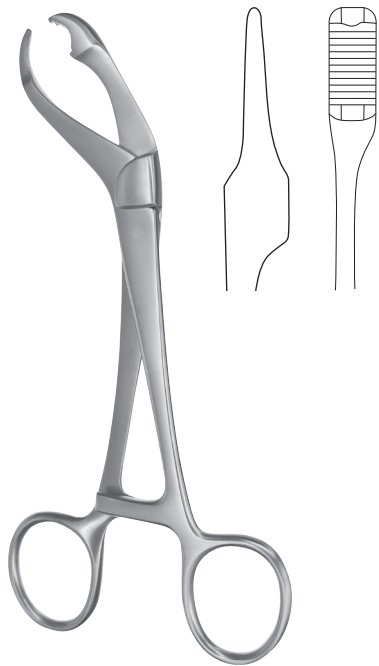

VERBRUGGE

kleines Modell
small pattern

17,5 cm – 7"

RU 5527-17



VERBRUGGE

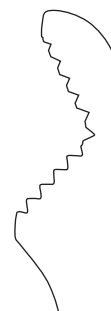

mit Lappenverschluss
with lip joint

25 cm – 10"

26 cm – 10¼"

27 cm – 10½"

RU 5527-25

RU 5527-26

RU 5527-27

Knochenhaltezangen Bone Holding Forceps



15 cm – 6"	RU 5528-15
19 cm – 7½"	RU 5528-19
24 cm – 9½"	RU 5528-24
26 cm – 10¼"	RU 5528-26
28 cm – 11"	RU 5528-28



Amputationsretraktor,
Griffe abnehmbar
*Amputation retractor,
removeable handles*

PERCY
RU 5529-30

1:4

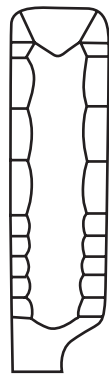

1:3
26 cm – 10¼"
RU 5533-26

FARABEU-F-LAMBOTTE



19 cm – 7½" **RU 5535-19**
23 cm – 9" **RU 5535-23**
26 cm – 10¼" **RU 5535-26**

LAMBOTTE

Knochenhaltezangen Bone Holding Forceps



LANE

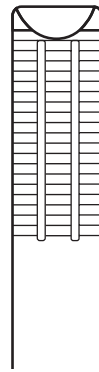

ohne Sperre mit Sperre
without ratchet with ratchet

33 cm – 13"	RU 5534-33	RU 5536-33
45 cm – 17¾"	RU 5534-45	RU 5536-45



14,5 cm – 5¾"
RU 5537-14



13,5 cm – 5¼"
RU 5538-12



13,5 cm – 5¼"
RU 5539-13



20 cm – 8"
RU 5539-20



17 cm – 6¾"
RU 5540-17



Patellazange
Patella forceps

17,5 cm – 7"
RU 5540-01



LOWMAN

18 cm – 7"	RU 5542-18
20 cm – 8"	RU 5542-20
22 cm – 8¾"	RU 5542-22



MINI-LOWMAN

12 cm – 4¾"	RU 5543-12
-------------	-------------------



STELLBRINK

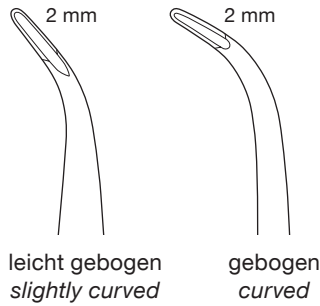

leicht gebogen
slightly curved

gebogen
curved

17 cm – 6¾"

RU 5558-01

RU 5558-02



BANE-HARTMANN



gebogen
curved

17,5 cm – 7"

RU 5559-17



MINI-FRIEDMANN

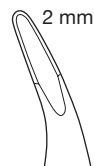

gebogen
curved

12,5 cm – 5"

RU 5560-12



LUER-FRIEDMANN



leicht gebogen
slightly curved

14 cm – 5½"

RU 5560-14

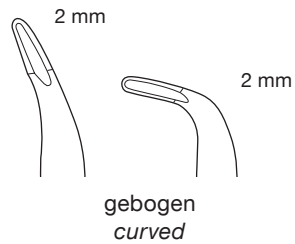

14 cm – 5½"

RU 5561-15 | **RU 5561-90**

FRIEDMANN-DELIKAT



gebogen
curved

14 cm – 5½"

RU 5562-14

17 cm – 6¾"

RU 5562-17

CLEVELAND

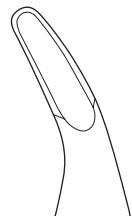
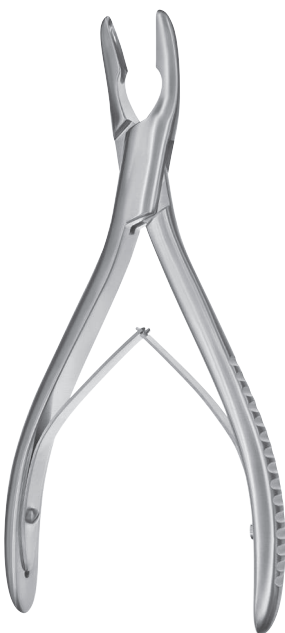

gebogen
curved

18,5 cm – 7¼"

RU 5563-18

HARTMANN

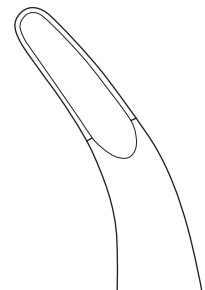

gebogen
curved

20 cm – 8"

RU 5565-20

OLIVECRONA

Hohlmeißelzangen Bone Rongeurs

4 mm

gebogen
curved

16,5 cm – 6½"

RU 5566-16

4 mm

gebogen
curved

16,5 cm – 6½"

RU 5568-16

MEAD



LEMPERT

3 mm

gerade
straight

16 cm – 6¼"	RU 5570-16
19 cm – 7½"	RU 5570-19

3 mm

gebogen
curved

16 cm – 6¼"	RU 5571-16
19 cm – 7½"	RU 5571-19



3 mm

gebogen
curved

18 cm – 7"

RU 5572-18

BEYER



4 mm

gerade
straight

17,5 cm – 7"	RU 5573-17
--------------	-------------------

4 mm

gebogen
curved

17,5 cm – 7"	RU 5574-17
--------------	-------------------

JANSEN



BLUMENTHAL

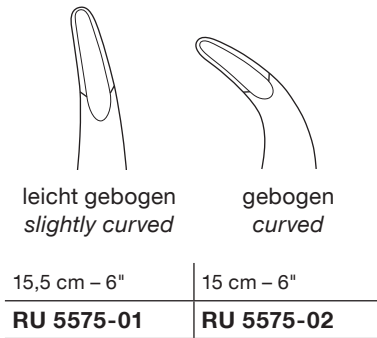

HAKANSSON

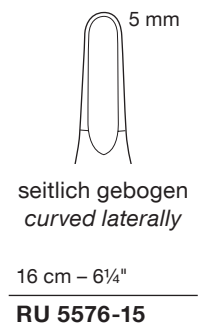

JANSEN

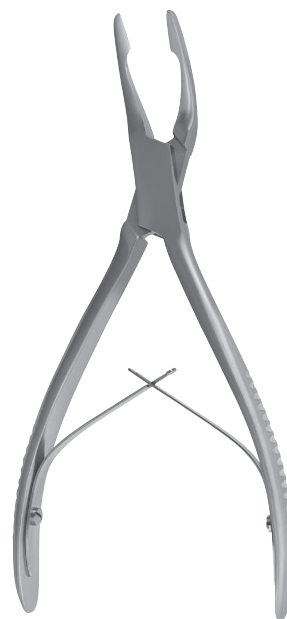
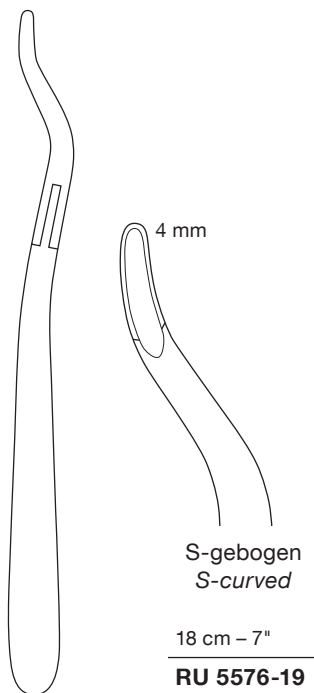

COTTLE-JANSEN

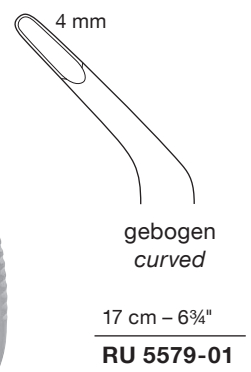

Hohlmeißelzangen Bone Rongeurs

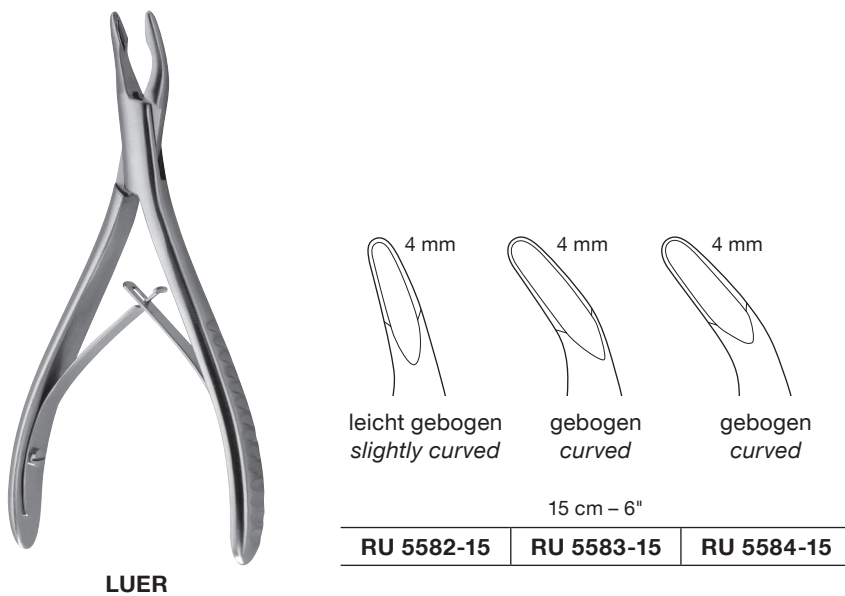
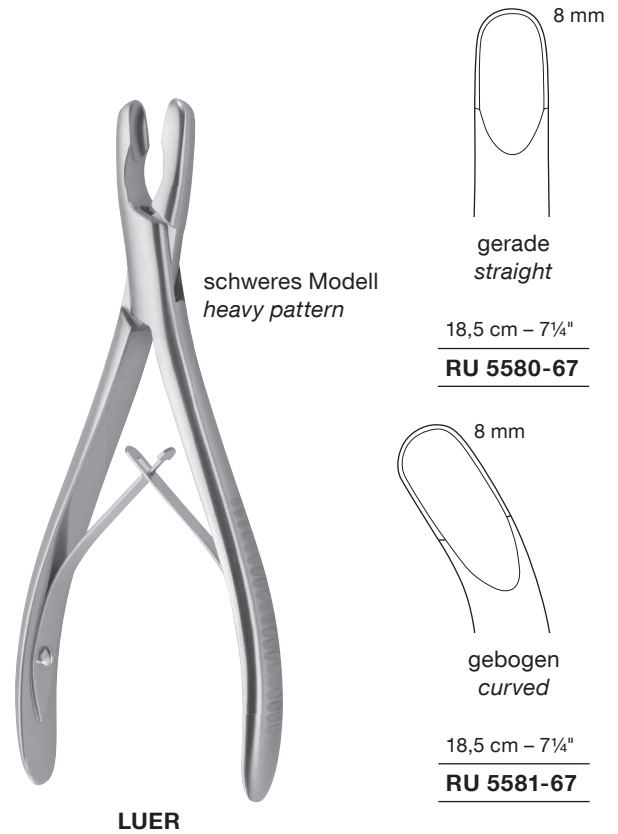
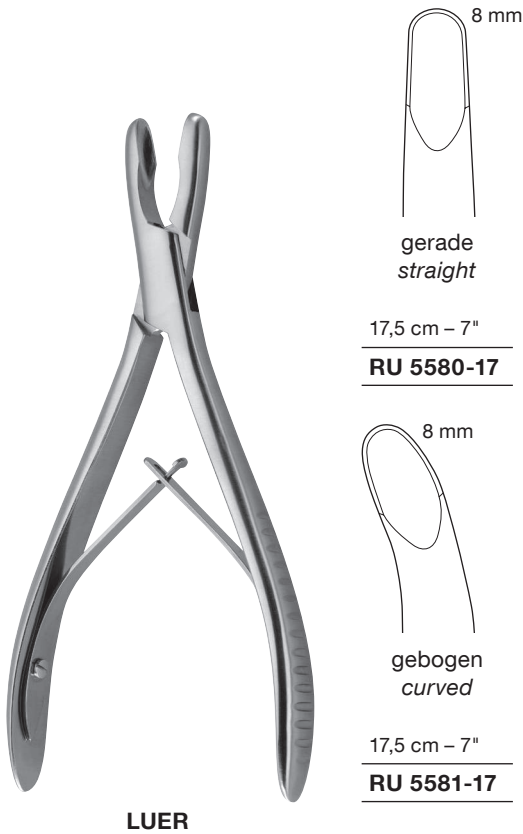

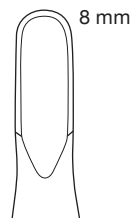
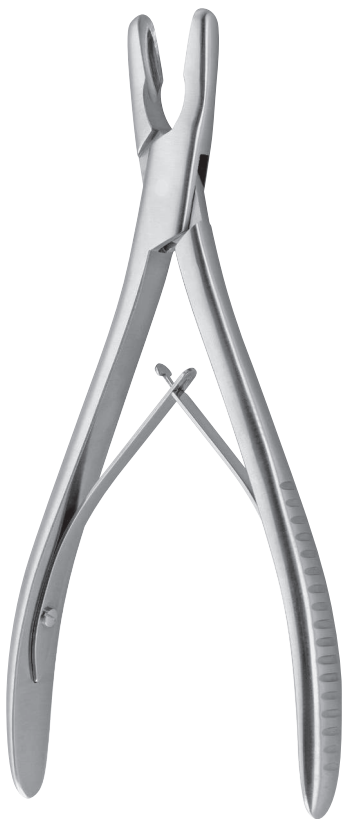

gerade
straight

20,5 cm – 8"

RU 5585-01

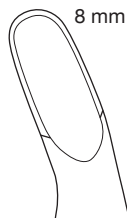

gebogen
curved

20,5 cm – 8"

RU 5585-02

ADSON

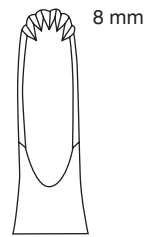

gerade, gezahnt
straight, saw edge

20,5 cm – 8"

RU 5585-21

ADSON

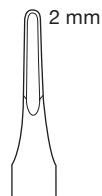

gerade
straight

15 cm – 6"

RU 5587-02



gebogen
curved

15 cm – 6"

RU 5587-12

KLEINERT-KUTZ

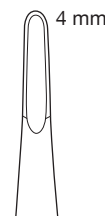

gerade
straight

15,5 cm – 6"

RU 5588-15



gebogen
curved

RU 5589-15

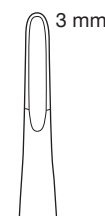

gerade
straight

15,5 cm – 6"

RU 5588-03

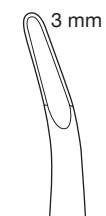

gebogen
curved

RU 5589-13

BÖHLER



ZAUFAL-JANSEN

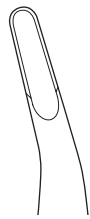

gebogen
curved

18 cm – 7"

RU 5590-18



BEYER

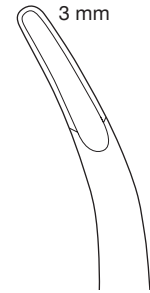

gebogen
curved

18 cm – 7"

RU 5592-18



MAYFIELD

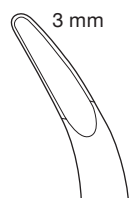

gebogen
curved

17,5 cm – 7"

RU 5593-17



RUSKIN

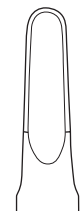

gerade
straight

18 cm – 7"

RU 5594-02



RUSKIN

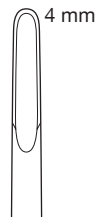

gerade
straight



gebogen
curved

18 cm – 7"

RU 5594-24

RU 5594-34

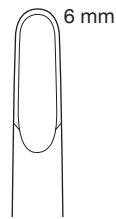

gerade
straight

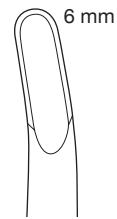

gebogen
curved

18 cm – 7"

RU 5594-51

RU 5594-18

23,5 cm – 9¼"

RU 5594-53

RU 5594-23



MARQUARDT

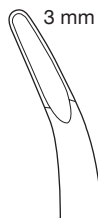

gebogen
curved

20 cm – 8"

RU 5595-20



RÖTTGEN-RUSKIN

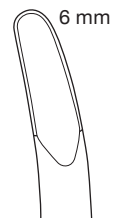

gebogen
curved

24 cm – 9½"

RU 5596-24



SMITH-PETERSEN

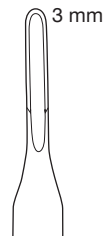

gerade
straight



leicht gebogen
slightly curved

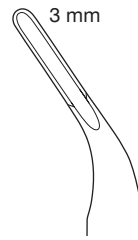

gebogen
curved

24 cm – 9½"

RU 5597-03

RU 5597-13

RU 5597-23

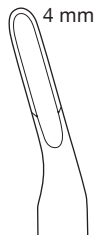

leicht gebogen
slightly curved

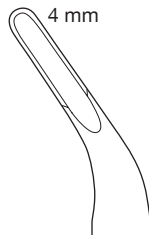

gebogen
curved

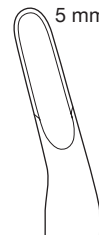

leicht gebogen
slightly curved

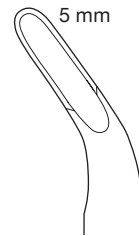

gebogen
curved

24 cm – 9½"

RU 5597-14

RU 5597-24

RU 5597-15

RU 5597-25



STILLE-LUER

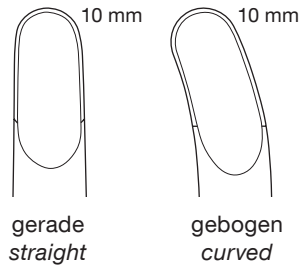

22 cm – 8¾"

RU 5600-22	RU 5601-22
-------------------	-------------------



STILLE-LUER

1:3

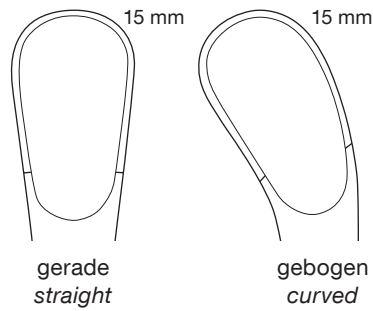

27 cm – 10½"

RU 5600-27	RU 5601-27
-------------------	-------------------

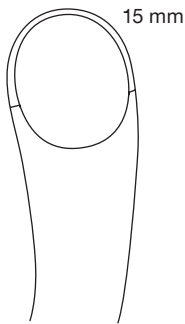

gebogen
curved

23 cm – 9"

RU 5602-23

SEMB

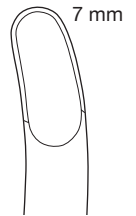

gebogen
curved

24 cm – 9½"

RU 5604-23

STILLE-RUSKIN

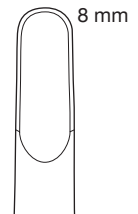
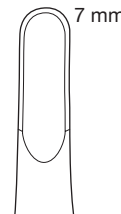
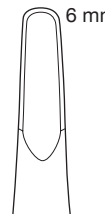
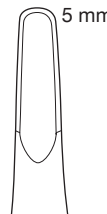
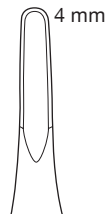
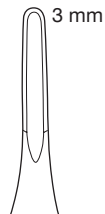

seitlich gebogen
curved sideways

23,5 cm – 9¼"

RU 5606-03	RU 5606-04	RU 5606-05	RU 5606-06	RU 5606-07	RU 5606-08
-------------------	-------------------	-------------------	-------------------	-------------------	-------------------

LEKSELL

1:3



LEKSELL

1:3

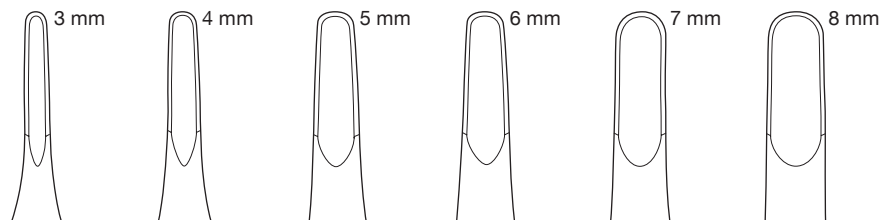

seitlich gebogen
curved sideways

23 cm – 9"

RU 5606-13	RU 5606-14	RU 5606-15	RU 5606-16	RU 5606-17	RU 5606-18
-------------------	-------------------	-------------------	-------------------	-------------------	-------------------



STILLE

1:3

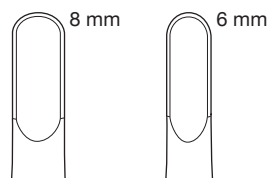

seitlich gebogen
curved sideways

23 cm – 9"

RU 5608-08	RU 5608-23
-------------------	-------------------

Knochensplitterzangen Bone Cutting Forceps



LISTON

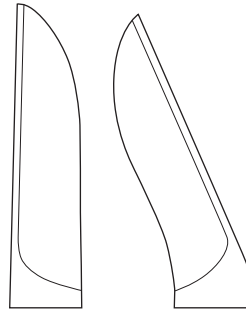

gerade
straight

gebogen
curved

14 cm – 5½"	RU 5640-14	RU 5641-14
17 cm – 6¾"	RU 5640-17	RU 5641-17
20 cm – 8"	RU 5640-19	RU 5641-19
22 cm – 8¾"	RU 5640-22	RU 5641-22

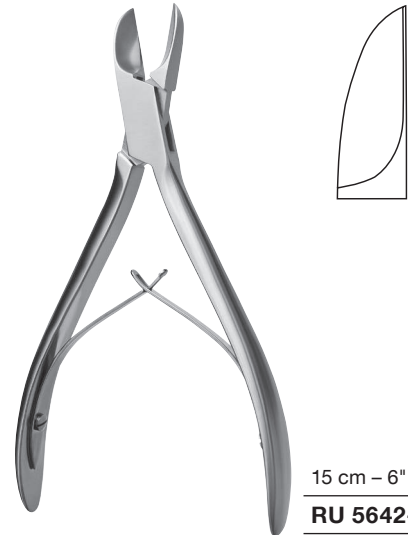

LITTAUER-LISTON

15 cm – 6"	RU 5642-15
------------	-------------------



BÖHLER



gerade
straight

gebogen
curved

15 cm – 6"

RU 5700-15	RU 5701-15
-------------------	-------------------

Knochensplitterzangen Bone Cutting Forceps

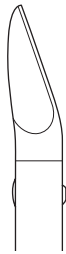

17,5 cm – 7"

RU 5702-17

MC INDOE



18 cm – 7"

RU 8125-18

KAZANJIAN



gerade
straight



gebogen
curved

18,5 cm – 7¼"

RU 5710-18

RU 5711-18

RUSKIN-LISTON

Knochensplitterzangen Bone Cutting Forceps



STILLE-LISTON

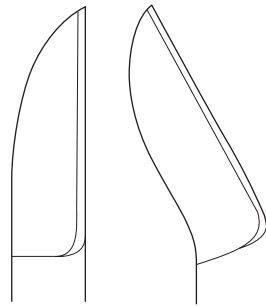

gerade
straight

gebogen
curved

23 cm – 9"	RU 5716-23	RU 5717-23
27 cm – 10½"	RU 5716-27	RU 5717-27

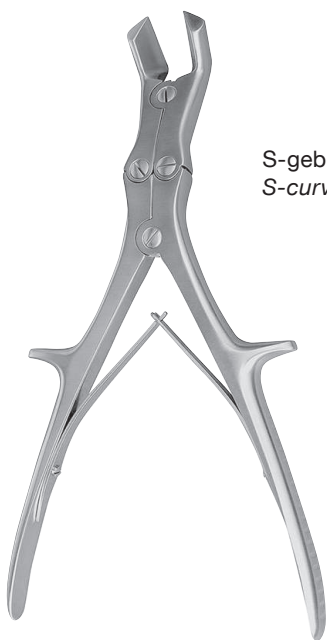

LISTON-KEY-HORSLEY

S-gebogen
S-curved

1:3

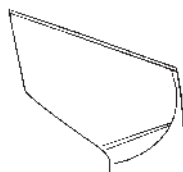

27 cm – 10½"

RU 5718-27

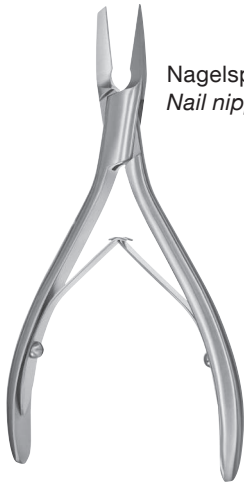

Nagelspaltzange
Nail nipper

13,5 cm – 5¼"

RU 5722-13



Rundzange
Round pliers

18 cm – 7"

RU 5723-04



Flachzange
Flat nose pliers

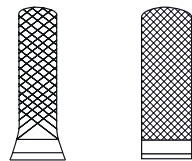

18 cm – 7"

RU 5723-18 | **RU 5724-18**



Nagelausreißzange
Nail pulling forceps



13,5 cm – 5¼"

RU 5726-13

RADOLF



Sägeblatt, allein
Saw blade, only

RU 5727-21

Fingerringsäge,
kompl. mit 1 Sägeblatt
*Finger ring saw,
compl. with 1 saw blade*

17 cm – 6¾"

RU 5727-17



Sägeblatt, allein,
für Hartmetall nicht geeignet
*Saw blade, only,
not suitable for carbide metal*

RU 5728-21

Fingerringsäge,
kompl. mit 1 Sägeblatt
*Finger ring saw,
compl. with 1 saw blade*

15 cm – 6"

RU 5728-17



Sägeblatt, allein
Saw blade, only

RU 5732-99

31 cm – 12¼"

RU 5732-31

1:3

SATTERLEE



1:3
CHARRIÈRE

Sägeblatt, allein
Saw blade, only

RU 5735-99

27 cm – 10½"

RU 5735-27



CHARRIÈRE

Säge komplett, bestehend aus:
Saw complete, consisting of:

RU 5736-35

1 Säge 35 cm – 13¾"

1 Saw 35 cm – 13¾"

1 Sägeblatt 12 mm (RU 5736-42)

1 Saw blade 12 mm (RU 5736-42)

1 Sägeblatt 15 mm (RU 5736-45)

1 Saw blade 15 mm (RU 5736-45)

Blattbreite <i>Blade width</i>	Sägeblätter <i>Saw blades</i>
12 mm	RU 5736-42
15 mm	RU 5736-45



HUDSON

Bohrapparat komplett, bestehend aus: <i>Hand drill complete, consisting of:</i>	RU 5744-00
--	-------------------

- Griff, allein (RU 5744-10)
Handle, only (RU 5744-10)
- Fräser Fig. 1 (RU 5744-01)
Cutter Fig. 1 (RU 5744-01)
- Fräser Fig. 2 (RU 5744-02)
Cutter Fig. 2 (RU 5744-02)
- Fräser Fig. 3 (RU 5744-03)
Cutter Fig. 3 (RU 5744-03)
- Fräser Fig. 4 (RU 5744-04)
Cutter Fig. 4 (RU 5744-04)
- Verlängerungsstück Fig. 9 (RU 5744-09)
Extension piece Fig. 9 (RU 5744-09)



HUDSON

CUSHING

MC KENZIL

ERRICO

Fig. 1	Fig. 2	Fig. 3	Fig. 4	Fig. 5			
Ø 9 mm	Ø 14 mm	Ø 16 mm	Ø 22 mm	Ø 14 mm	Ø 2 mm	Ø 13 mm	Ø 16 mm
RU 5744-01	RU 5744-02	RU 5744-03	RU 5744-04	RU 5744-05	RU 5744-06	RU 5744-07	RU 5744-08



STILLE

Bohrapparat komplett, bestehend aus: <i>Hand drill complete, consisting of:</i>	RU 5746-00
--	-------------------

Griff, allein 24 cm – 9½" (RU 5746-10)
Handle, only 24 cm – 9½" (RU 5746-10)

Bohrer Fig. 1 (RU 5746-01)
Drill Fig. 1 (RU 5746-01)

Bohrer Fig. 2 (RU 5746-02)
Drill Fig. 2 (RU 5746-02)

Bohrer Fig. 3 (RU 5746-03)
Drill Fig. 3 (RU 5746-03)

Bohrer Fig. 4 (RU 5746-04)
Drill Fig. 4 (RU 5746-04)

Bohrer Fig. 5 (RU 5746-05)
Drill Fig. 5 (RU 5746-05)

Fräser Fig. 6 (RU 5746-06)
Cutter Fig. 6 (RU 5746-06)

Fräser Fig. 7 (RU 5746-07)
Cutter Fig. 7 (RU 5746-07)

Fräser Fig. 8 (RU 5746-08)
Cutter Fig. 8 (RU 5746-08)

Fräser Fig. 9 (RU 5746-09)
Cutter Fig. 9 (RU 5746-09)

Griff, allein
Handle, only

24 cm – 9½"

RU 5746-10



Fig. 1	Fig. 2	Fig. 3	Fig. 4	Fig. 5	Fig. 6	Fig. 7	Fig. 8	Fig. 9
Ø 2,5 mm	Ø 3 mm	Ø 3,5 mm	Ø 4 mm	Ø 10 mm	Ø 5 mm	Ø 8 mm	Ø 12 mm	Ø 16 mm
RU 5746-01	RU 5746-02	RU 5746-03	RU 5746-04	RU 5746-05	RU 5746-06	RU 5746-07	RU 5746-08	RU 5746-09



Bohrapparat mit umstellbaren Handgriff:
Hand drill with adjustable handle:

RU 5746-50

- 1 Dreibackenspannfutter
- 1 *Three-jaw-chuck*
- 1 Schlüssel
- 1 *Wrench*



Handgriff mit Jacobs-Spannfutter
0,5 - 7 mm und Spanschlüssel, allein
*Handle with Jacobs chuck 0.5 - 7 mm
and wrench, only*

RU 5747-01



Spanschlüssel, allein
Wrench, only

RU 5747-11



14 cm – 5½"

RU 5749-06

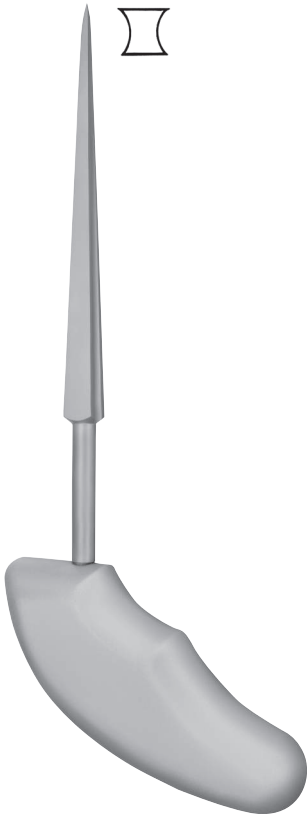

21 cm – 8¼"

RU 5749-11

PERTHES



14 cm – 5½"

RU 5749-19



Trokarspitze, mit flachem Ende
(Verpackungseinheit à 10 Stück)
*Trocar point, with flat shaft
(Packing unit 10 pieces)*

1:1
KIRSCHNER

Ø mm	Länge Length			
	60 mm – 2½"	100 mm – 4"	155 mm – 6"	310 mm – 12¼"
0,8	RU 5750-08	RU 5751-08	RU 5754-08	RU 5755-08
1	RU 5750-10	RU 5751-10	RU 5754-10	RU 5755-10
1,1	RU 5750-11	RU 5751-11	RU 5754-11	RU 5755-11
1,2	RU 5750-12	RU 5751-12	RU 5754-12	RU 5755-12
1,4	RU 5750-14	RU 5751-14	RU 5754-14	RU 5755-14
1,5	RU 5750-15	RU 5751-15	RU 5754-15	RU 5755-15
1,6	RU 5750-16	RU 5751-16	RU 5754-16	RU 5755-16
1,7	RU 5750-17	RU 5751-17	RU 5754-17	RU 5755-17
1,8	RU 5750-18	RU 5751-18	RU 5754-18	RU 5755-18
1,9	RU 5750-19	RU 5751-19	RU 5754-19	RU 5755-19
2	RU 5750-20	RU 5751-20	RU 5754-20	RU 5755-20
2,2	RU 5750-22	RU 5751-22	RU 5754-22	RU 5755-22
2,5	RU 5750-25	RU 5751-25	RU 5754-25	RU 5755-25
2,8	RU 5750-28	RU 5751-28	RU 5754-28	RU 5755-28
3	RU 5750-30	RU 5751-30	RU 5754-30	RU 5755-30



Trokarspitze, mit rundem Ende
(Verpackungseinheit à 10 Stück)
*Trocar point, with round shaft
(Packing unit 10 pieces)*

1:1

Ø mm	Länge Length			
	60 mm – 2½"	100 mm – 4"	155 mm – 6"	310 mm – 12¼"
0,8	RU 5750-38	RU 5751-38	RU 5754-38	RU 5755-38
1	RU 5750-40	RU 5751-40	RU 5754-40	RU 5755-40
1,1	RU 5750-41	RU 5751-41	RU 5754-41	RU 5755-41
1,2	RU 5750-42	RU 5751-42	RU 5754-42	RU 5755-42
1,4	RU 5750-44	RU 5751-44	RU 5754-44	RU 5755-44
1,5	RU 5750-45	RU 5751-45	RU 5754-45	RU 5755-45
1,6	RU 5750-46	RU 5751-46	RU 5754-46	RU 5755-46
1,7	RU 5750-47	RU 5751-47	RU 5754-47	RU 5755-47
1,8	RU 5750-48	RU 5751-48	RU 5754-48	RU 5755-48
1,9	RU 5750-49	RU 5751-49	RU 5754-49	RU 5755-49
2	RU 5750-50	RU 5751-50	RU 5754-50	RU 5755-50
2,2	RU 5750-52	RU 5751-52	RU 5754-52	RU 5755-52
2,5	RU 5750-55	RU 5751-55	RU 5754-55	RU 5755-55
2,8	RU 5750-58	RU 5751-58	RU 5754-58	RU 5755-58
3	RU 5750-60	RU 5751-60	RU 5754-60	RU 5755-60



1:1

Trokarspitze, mit Trokarende
(Verpackungseinheit à 10 Stück)
Trocar point, with trocar shaft
(Packing unit 10 pieces)

Ø mm	Länge Length		
	100 mm – 4"	155 mm – 6"	310 mm – 12¼"
0,8	RU 5756-08	RU 5756-38	RU 5756-68
1	RU 5756-10	RU 5756-40	RU 5756-70
1,1	RU 5756-11	RU 5756-41	RU 5756-71
1,2	RU 5756-12	RU 5756-42	RU 5756-72
1,4	RU 5756-14	RU 5756-44	RU 5756-74
1,5	RU 5756-15	RU 5756-45	RU 5756-75
1,6	RU 5756-16	RU 5756-46	RU 5756-76
1,7	RU 5756-17	RU 5756-47	RU 5756-77
1,8	RU 5756-18	RU 5756-48	RU 5756-78
1,9	RU 5756-19	RU 5756-49	RU 5756-79
2	RU 5756-20	RU 5756-50	RU 5756-80
2,2	RU 5756-22	RU 5756-52	RU 5756-82
2,5	RU 5756-25	RU 5756-55	RU 5756-85
2,8	RU 5756-28	RU 5756-58	RU 5756-88
3	RU 5756-30	RU 5756-60	RU 5756-90



15 mm

Trokarspitze, mit Gewinde
(Verpackungseinheit à 10 Stück)
Trocar point, with thread
(Packing unit 10 pieces)



1:1

Ø mm	Länge Length	
	155 mm – 6"	310 mm – 12¼"
1,2	RU 5754-72	RU 5755-72
1,4	RU 5754-74	RU 5755-74
1,6	RU 5754-76	RU 5755-76
1,8	RU 5754-78	RU 5755-78
2	RU 5754-80	RU 5755-80
2,2	RU 5754-82	RU 5755-82
2,5	RU 5754-85	RU 5755-85

Bohrdrähte, Steinmann-Nägel Drill Wires, Steinmann Pins



Lanzenspitze
(Verpackungseinheit à 10 Stück)
Lance point
(Packing unit 10 pieces)

● 1:1

	Länge Length
Ø mm	310 mm – 12¼"
0,8	RU 5758-08
0,9	RU 5758-09
1	RU 5758-10
1,1	RU 5758-11
1,2	RU 5758-12
1,3	RU 5758-13
1,4	RU 5758-14
1,5	RU 5758-15
1,6	RU 5758-16
1,7	RU 5758-17
1,8	RU 5758-18
1,9	RU 5758-19
2	RU 5758-20
2,2	RU 5758-22
2,4	RU 5758-24
2,5	RU 5758-25
2,6	RU 5758-26
2,8	RU 5758-28
3	RU 5758-30



Trokarspitze, mit 3-kant Ende
Trocar point, with triangular end

● 1:1

Länge Length	Ø 4 mm	Ø 4,5 mm	Ø 5 mm
8 cm	RU 5784-08	RU 5785-08	RU 5786-08
10 cm	RU 5784-10	RU 5785-10	RU 5786-10
12 cm	RU 5784-12	RU 5785-12	RU 5786-12
14 cm	RU 5784-14	RU 5785-14	RU 5786-14
16 cm	RU 5784-16	RU 5785-16	RU 5786-16
18 cm	RU 5784-18	RU 5785-18	RU 5786-18
20 cm	RU 5784-20	RU 5785-20	RU 5786-20
22 cm	RU 5784-22	RU 5785-22	RU 5786-22
25 cm	RU 5784-25	RU 5785-25	RU 5786-25
30 cm	RU 5784-30	RU 5785-30	RU 5786-30

STEINMANN

Drahtspannzangen Wire Twisting Forceps

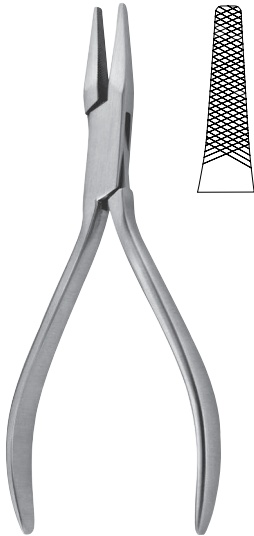

14 cm – 5½"
RU 5760-14



16 cm – 6¼"
RU 5760-16



Körnung 0,5 mm
Grit 2500 tpsi



Typ / Type	18,5 cm – 7¼"	17,5 cm – 7"		
TC	RU 5761-17	RU 5761-18	RU 5761-19	RU 5761-20

Drahtspannzangen Wire Twisting Forceps

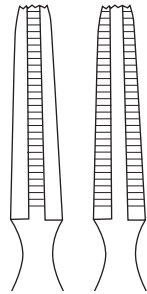

13 cm – 5"	RU 5761-41
18 cm – 7"	RU 5761-42



Körnung 0,5 mm
Grit 2500 tpsi



Typ / Type	18 cm – 7"
TC	RU 5761-08



Typ / Type	20 cm – 8"
TC	RU 5761-09



Körnung 0,5 mm
Grit 2500 tpsi



Typ / Type	15 cm – 6"	20 cm – 8"	15 cm – 6"
TC	RU 5761-10	RU 5761-11	RU 5761-12

Drahtfasszangen Wire Holding Forceps



Körnung 0,5 mm
Grit 2500 tpsi

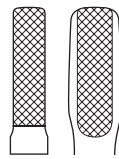

Typ / Type	17 cm – 6¾"
TC	RU 5761-15



Drahtschneide- und Biegezange
Wire cutting and bending pliers



Schneide
Cutting edge

weich / soft	1.5 mm
hart / hard	1.0 mm

16 cm – 6¼"
RU 5759-16

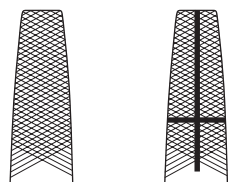

17 cm – 6¾"

RU 5761-31	RU 5761-32
-------------------	-------------------

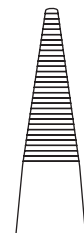

19 cm – 7½"

RU 5761-33

Flachzangen
Flat Nose Pliers



rostfreier Stahl
stainless steel

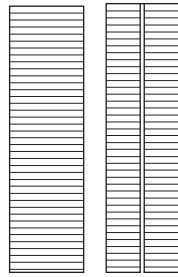

18,5 cm – 7¼"

RU 5764-00



rostfreier Stahl
stainless steel



18 cm – 7"

RU 5764-51



18 cm – 7"

RU 5764-60

Drahtschneidezangen Wire Cutting Pliers



für weichen Knochen Draht bis Ø
für harte Bohrdrähte/Knochen Nägel bis Ø
for soft bone wire with a max. diameter of
for hard drill wires/bone nails with a max. diameter of



weich soft	Ø 2 mm
hart hard	Ø 1,5 mm

Typ / Type	15 cm – 6"
TC	RU 5762-15



weich soft	Ø 1,7 mm
---------------	----------

Drahtschneider durchbohrt
Cannulated wire cutter

	18,5 cm – 7¼"
	RU 5762-18



weich soft	Ø 2 mm
hart hard	Ø 2 mm

	16 cm – 6¼"
	RU 5762-50



weich soft	Ø 3,5 mm
hart hard	Ø 3,5 mm

	24 cm – 9½"
1:3	RU 5765-24

Drahtschneidezangen Wire Cutting Pliers



für weichen Knochen Draht bis Ø
für harte Bohrdrähte/Knochnägel bis Ø
for soft bone wire with a max. diameter of
for hard drill wires/bone nails with a max. diameter of



hart hard	Ø 0,6 mm
--------------	----------



Typ / Type	12 cm – 4¾"
TC	RU 5766-12



weich soft	Ø 1,5 mm
hart hard	Ø 1 mm



Typ / Type	15 cm – 6"
TC	RU 5766-24



weich soft	Ø 2 mm
hart hard	Ø 1,7 mm

Typ / Type	18 cm – 7"
TC	RU 5767-18



weich soft	Ø 3 mm
hart hard	Ø 2,5 mm

Typ / Type	22 cm – 8¾"
TC	RU 5767-22

**MODELL RUDOLF
RUDOLF PATTERN**

Drahtschneidezangen Wire Cutting Pliers



für weichen Knochendraht bis Ø
für harte Bohrdrähte/Knochnägel bis Ø
for soft bone wire with a max. diameter of
for hard drill wires/bone nails with a max. diameter of



weich soft	Ø 2,5 mm
hart hard	Ø 1,5 mm

Typ / Type	18,5 cm – 7¼"
TC	RU 5768-18

**MODELL RUDOLF
RUDOLF PATTERN**



Bolzenschneider zum Abzwicken
von Drähten, Schrauben und
Nägeln bis zu Ø 6 mm
Cutter for cutting off wires,
bolts and pins up to Ø 6 mm



1:3



1:3

47 cm – 18½"	RU 5767-47
54 cm – 21¼"	RU 5767-57

1:4

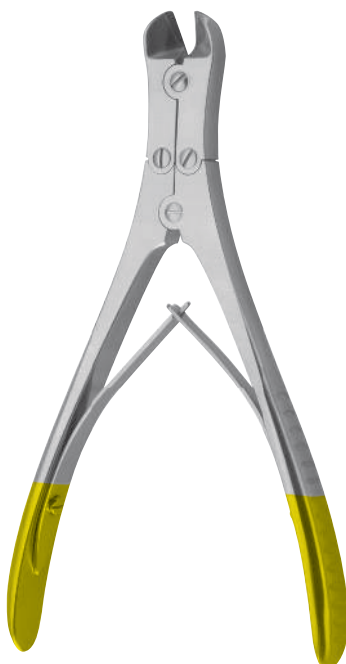

Typ / Type	18 cm – 7"
TC	RU 5769-18
weich soft	Ø 2 mm
hart hard	Ø 1,7 mm

Typ / Type	22 cm – 8¾"
TC	RU 5769-22
weich soft	Ø 3 mm
hart hard	Ø 2,5 mm



hart hard	Ø 2,2 mm
--------------	----------

Typ / Type	23,5 cm – 9¼"
TC	RU 5769-32

1:3

Extensionsbügel Extension Bows

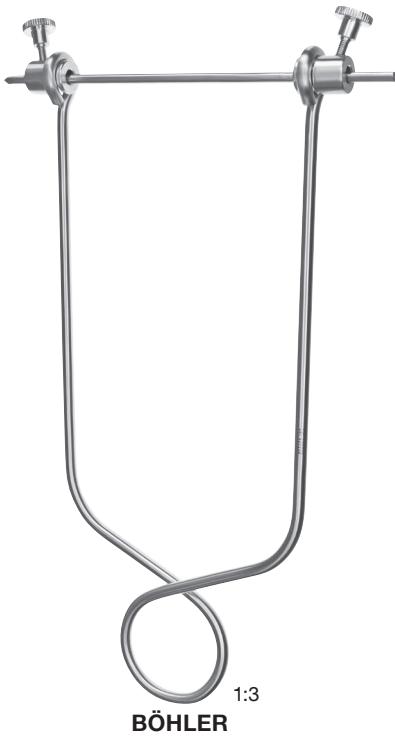

mit 1 Nagel
with 1 pin

für Arm
for arm

16 x 9 cm – 6¼" x 3½"	RU 5770-16
-----------------------	-------------------

für Oberschenkel und Knie
for thigh and knee

21 x 11 cm – 8¼" x 4¼"	RU 5770-21
------------------------	-------------------



RU 5773-18	RU 5773-27
-------------------	-------------------

Optionales Zubehör, Ringgabelschlüssel
Optional accessories, Combination wrench

 Schlüsselweite, 10 - 14 Size, 10 - 14	10	RU 6319-10	—
	11	—	RU 6319-11
	12	—	RU 6319-12
	14	RU 6319-14	—

lichte Weite
clear width

18 x 10 cm – 7" x 4"	RU 5773-18
27 x 16 cm – 10½" x 6¼"	RU 5773-27



Gabelschlüssel, doppelendig
Wrench, open-ended

Schlüsselweite Size	8 / 9	RU 6319-89
------------------------	-------	-------------------

Knochendraht
in Ringen zu 10 m
*Bone wire
coil of 10 m*



Ø mm	weich soft
0,2	RU 5778-02
0,3	RU 5778-03
0,4	RU 5778-04
0,5	RU 5778-05
0,6	RU 5778-06
0,7	RU 5778-07
0,8	RU 5778-08
0,9	RU 5778-09
1,0	RU 5778-10
1,2	RU 5778-12
1,5	RU 5778-15

Drahtspanninstrument
Bone wire tighteners



21 cm – 8¼"
RU 5782-00

LOUTE

Drahtumführungsnaedeln
Bone wire guides



1:3

DEMEL

30,5 cm – 12"	Fig. 1	RU 5780-01
28,5 cm – 11¼"	Fig. 2	RU 5780-02
27,5 cm – 10¾"	Fig. 3	RU 5780-03

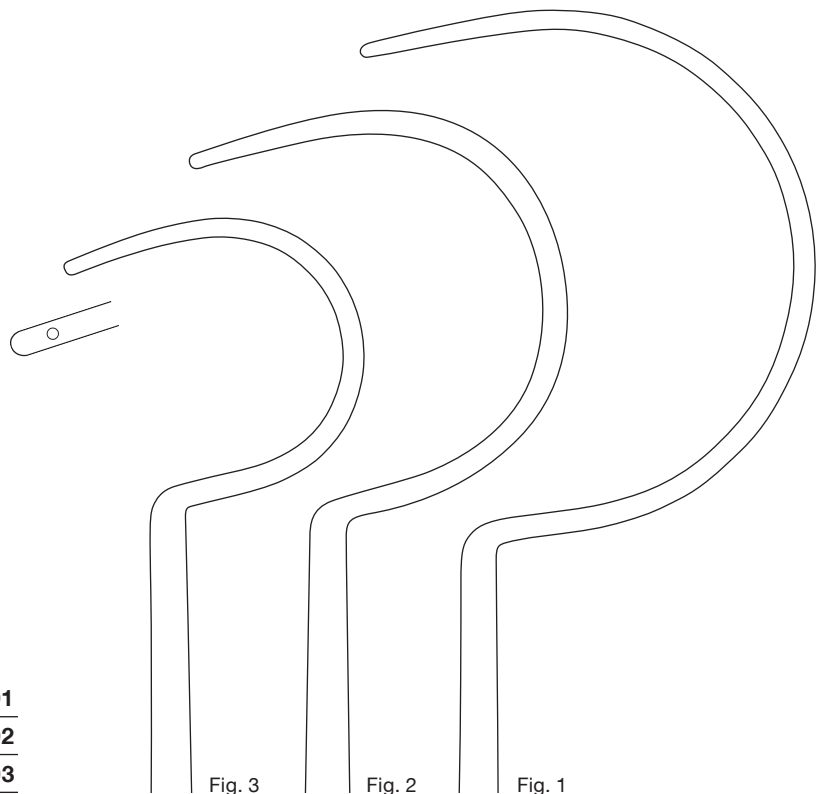

Fig. 3

Fig. 2

Fig. 1

Hämmer Mallets



Ø 25 mm
160 g

mit auswechselbarer
Kunststoffbacke
*with interchangeable
plastic disk*

1 Ersatzbacke
1 Spare disk

RU 5797-51

18,5 cm – 7¼"

RU 5797-17



Ø 30 mm
230 g

mit auswechselbaren
Kunststoffbacken
*with interchangeable
plastic disks*

Ersatzbackenpaar
Pair of spare disks

RU 5798-51

24 cm – 9½"

RU 5798-24



Ø 25 mm
135 g

mit auswechselbaren
Kunststoffbacken
*with interchangeable
plastic disks*

Ersatzbackenpaar
Pair of spare disks

RU 5799-51

19 cm – 7½"

RU 5799-18



Ø 30 mm
300 g

23,5 cm – 9¼"

RU 5800-23

1:3
BERGMANN

Hämmer Mallets



1:3

Ø 14 / 24 mm
420 g

Kopf massiv, aus
Implant-Werkstoff
*Head massive, made
of implantat material*

23,5 cm – 9¼"

RU 5801-23



1:3

BERGMANN

Ø 45 mm
380 g

24 cm – 9½"

RU 5802-24



Ø 30 mm
180 g

24 cm – 9½"

RU 5803-10

Ø 40 mm
350 g

24 cm – 9½"

RU 5803-35

Ø 45 mm
500 g

24 cm – 9½"

RU 5803-50

Ø 50 mm
700 g

24 cm – 9½"

RU 5803-70



Ø 30 / 42 mm
400 g

24 cm – 9½"

RU 5804-24

Hämmer Mallets

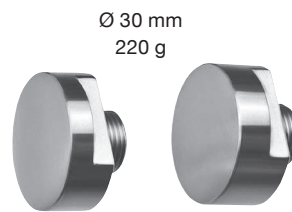

Metallbackenpaar
Pair of metal faces

RU 5807-00/01

Backen 1x konvex / 1x flach
faces 1x convex / 1x flat

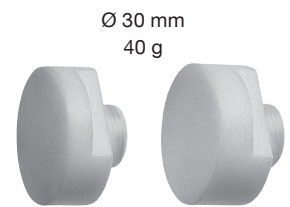

Kunststoffbackenpaar
Pair of synthetic faces

RU 5807-00/02

Backen 1x konvex / 1x flach
faces 1x convex / 1x flat



Schlüssel
Wrench

RU 5807-00/03



Ø 35 mm
100 g

26 cm – 10¼"

RU 5808-01

Ø 43 mm
170 g

26 cm – 10¼"

RU 5808-02

Ø 50 mm
220 g

26 cm – 10¼"

RU 5808-03

1:3



Ø 22 mm
170 g

Ø 22 mm
170 g

bleigefüllt
lead filled

19 cm – 7¾"

RU 5812-19



Ø 22 mm
135 g

Ersatzbackenpaar
Pair of spare disks

RU 5819-20

19,5 cm – 9½"

RU 5819-19

Hämmer Mallets



Ø 25 mm
220 g

19 cm – 7½"

RU 5820-19

GERZOG



Ø 30 mm
240 g

konvex / flach
convex / flat

19 cm – 7½"

RU 5809-19

COTTLE



Ø 27 mm
145 g

20 cm – 8"

RU 5811-23

HAJEK

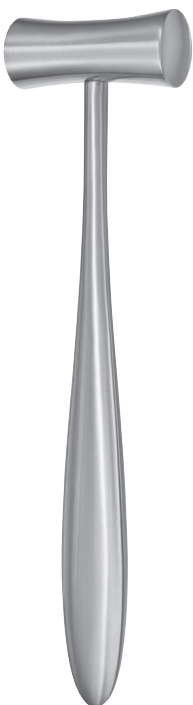

Ø 19 mm
80 g

19 cm – 7½"

RU 5813-01

LUCAE

Ø 25 mm
250 g

19 cm – 7½"

RU 5813-02



Ø 20 mm
100 g

bleigefüllt
lead filled

16,5 cm – 6½"

RU 5814-16

Ø 20 mm
75 g

Messing
Brass

16,5 cm – 6½"

RU 5815-16



MEAD

Ø 26 mm
170 g

mit auswechselbaren
Kunststoffbacken
*with interchangeable
plastic disks*

Ersatzbackenpaar
Pair of spare disks

RU 5816-20

19 cm – 7½"

RU 5816-17



PARTSCH

Ø 22 mm
115 g

bleigefüllt
lead filled

18 cm – 7"

RU 5819-18

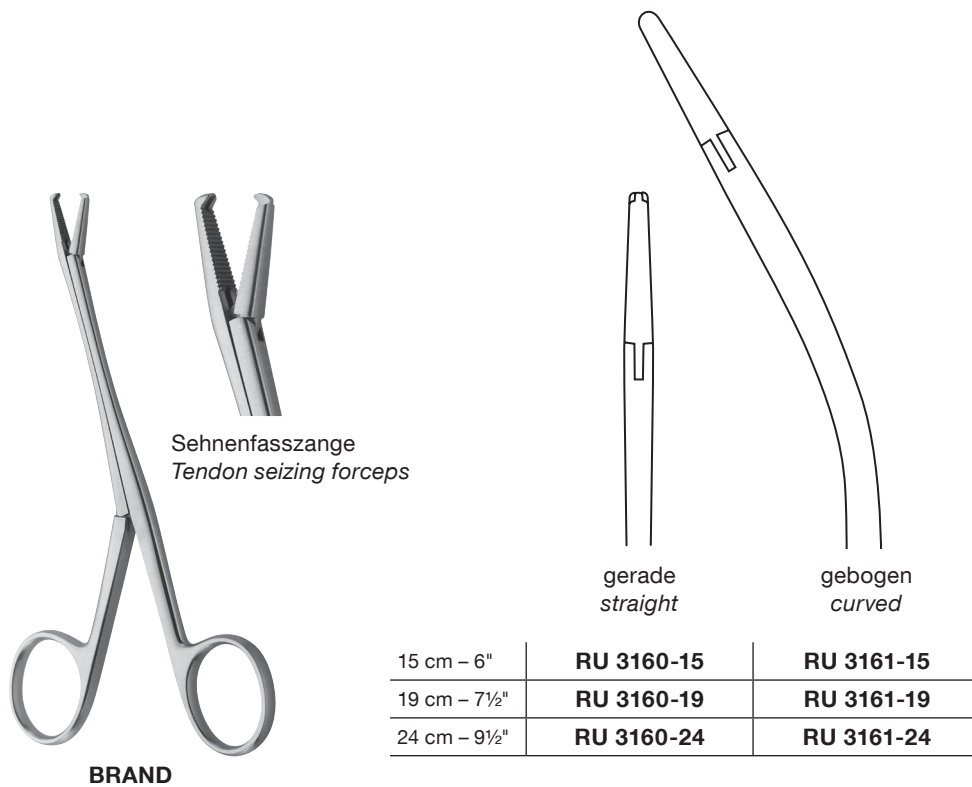
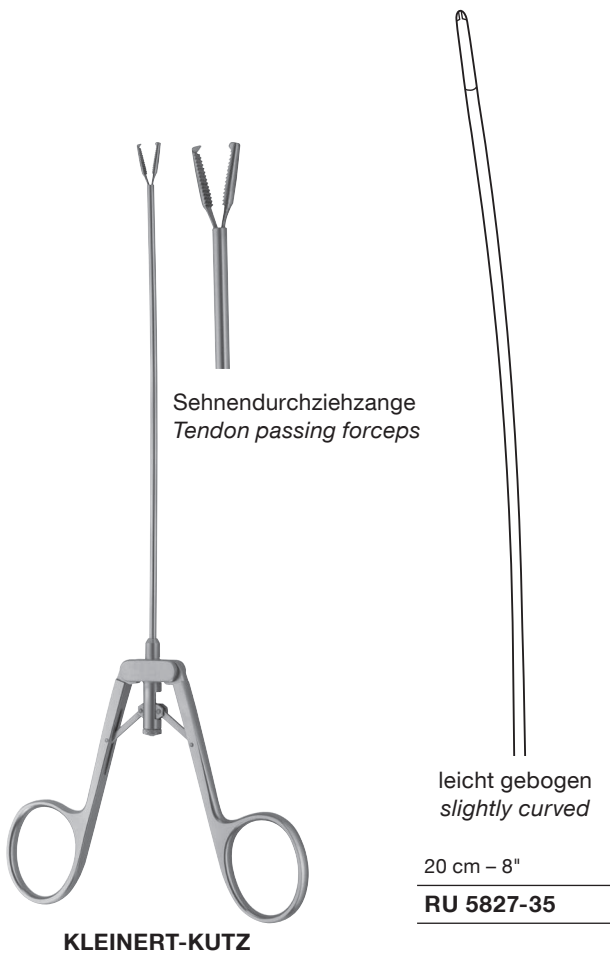

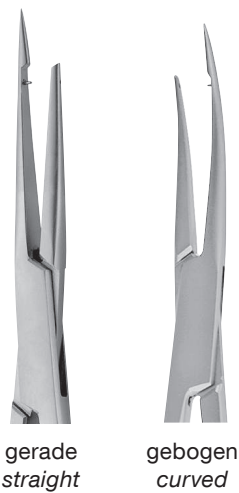
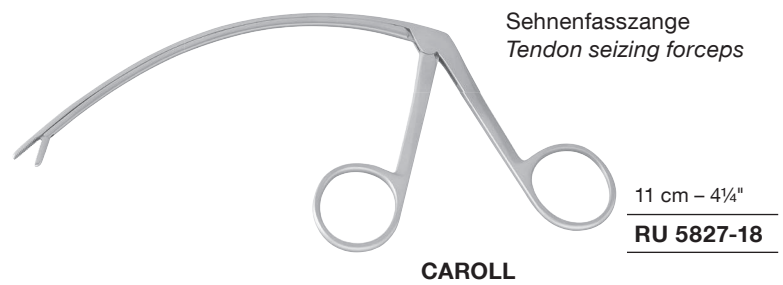

15 cm – 6"

RU 5827-20 | **RU 5827-21**

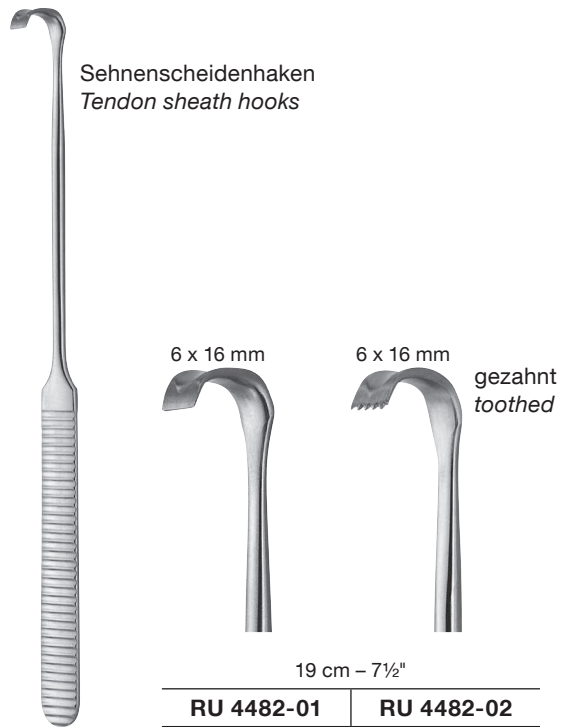

STRANDELL-STILLE



KLAPP



Bleihand für
Kinder
*Lead hand for
children*

RU 5822-01

Bleihand für
Erwachsene
*Lead hand
for adults*

RU 5822-02





HF-Handgriffe	<i>HF-Handles</i>	HF 1 - 2
Monopolare Elektroden	<i>Monopolar Electrodes</i>	HF 3 - 4
Bipolare Scheren	<i>Bipolar Scissors</i>	HF 5 - 6
Bipolare Pinzetten	<i>Bipolar Forceps</i>	HF 7 - 17
Bipolare Anschlusskabel	<i>Bipolar Connecting Cables</i>	HF 18

HF-Handgriffe

HF-Handles



zur Verwendung mit Elektroden Ø 2,4 mm und 6-kant Schaft
to be used with electrodes Ø 2.4 mm and 6-edge shaft

max. Spannung: 4,3 kVp
max. voltage: 4.3 kVp

Anschluss Geräteseite
Connection equipment side

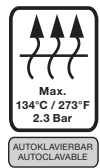

HF-Handgriff evoline

für Erbe ACC / ICC, Storz-Geräte

HF-Handle evoline

for Erbe ACC / ICC, Storz devices

mit integriertem Kabel
with integrated cable
 mit 2 Tasten
with 2 buttons

Länge / Length
 4 m

HF410-026

max. Spannung: 4,3 kVp
max. voltage: 4.3 kVp

Anschluss Geräteseite
Connection equipment side



HF-Handgriff evoline

für Berchtold / Martin / Aesculap / INTEGRA-Geräte

HF-Handle evoline

for Berchtold / Martin / Aesculap / INTEGRA devices

mit integriertem Kabel
with integrated cable
 mit 2 Tasten
with 2 buttons

Länge / Length
 4 m

HF410-028

max. Spannung: 4,3 kVp
max. voltage: 4.3 kVp

Anschluss Geräteseite
Connection equipment side



HF-Handgriff evoline

für Modelle mit internationalem Anschluss 3-polig

HF-Handle evoline

for models with international connection plug 3 pin

mit integriertem Kabel
with integrated cable
 mit 2 Tasten
with 2 buttons

Länge / Length
 4 m

HF410-030

HF-Handgriffe

HF-Handles



zur Verwendung mit Elektroden Ø 4 mm und 6-kant Schaft
to be used with electrodes Ø 4 mm and 6-edge shaft



max. Spannung: 4,3 kVp
max. voltage: 4.3 kVp

Anschluss Geräteseite
Connection equipment side



HF-Handgriff evoline

für Erbe ACC / ICC, Storz-Geräte

HF-Handle evoline

for Erbe ACC / ICC, Storz devices

mit integriertem Kabel
with integrated cable
 mit 2 Tasten
with 2 buttons

Länge / Length
 4 m

HF410-020

max. Spannung: 4,3 kVp
max. voltage: 4.3 kVp

Anschluss Geräteseite
Connection equipment side



HF-Handgriff evoline

für Berchtold / Martin / Aesculap / INTEGRA-Geräte

HF-Handle evoline

for Berchtold / Martin / Aesculap / INTEGRA devices

mit integriertem Kabel
with integrated cable
 mit 2 Tasten
with 2 buttons

Länge / Length
 3 m

HF410-022

max. Spannung: 4,3 kVp
max. voltage: 4.3 kVp

Anschluss Geräteseite
Connection equipment side



HF-Handgriff evoline

für Modelle mit internationalem Anschluss 3-polig

HF-Handle evoline

for models with international connection plug 3 pin

mit integriertem Kabel
with integrated cable
 mit 2 Tasten
with 2 buttons



Länge / Length
 3 m

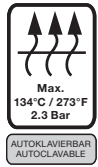

HF410-024

Monopolare Elektroden Monopolar Electrodes



6-kant Schaft
6-edge shaft





Modell Model	Beschreibung Description	Abmessungen Dimensions	2,4 mm Schaft 2.4 mm shaft
	Lanzetten-Elektrode Lancet electrode	20 mm x 2,5 mm	RU 0470-51
	Messer-Elektrode Knife electrode	20 mm x 2,5 mm	RU 0470-54
	Nadel-Elektrode Needle electrode	18 mm x Ø 0,7 mm	RU 0470-60



Modell Model	Beschreibung Description	Abmessungen Dimensions	2,4 mm Schaft 2.4 mm shaft
	Kugel-Elektrode Ball electrode	Ø 2 mm	RU 0470-65
		Ø 4 mm	RU 0470-67
		Ø 6 mm	RU 0470-69

Monopolare Elektroden Monopolar Electrodes



6-kant Schaft
6-edge shaft

Modell Model	Beschreibung Description	Abmessungen Dimensions	4 mm Schaft 4 mm shaft
	Lanzetten-Elektrode Lancet electrode	19 mm x 1,6 mm	RU 0470-01
	Lanzetten-Elektrode Lancet electrode	19 mm x 1,6 mm	RU 0470-02
	Messer-Elektrode Knife electrode	25 mm x 3,3 mm	RU 0470-04
	Nadel-Elektrode Needle electrode	22 mm x Ø 0,8mm	RU 0470-10

Modell Model	Beschreibung Description	Abmessungen Dimensions	4 mm Schaft 4 mm shaft
	Kugel-Elektrode Ball electrode	Ø 2 mm	RU 0470-15
		Ø 4 mm	RU 0470-17
		Ø 6 mm	RU 0470-19

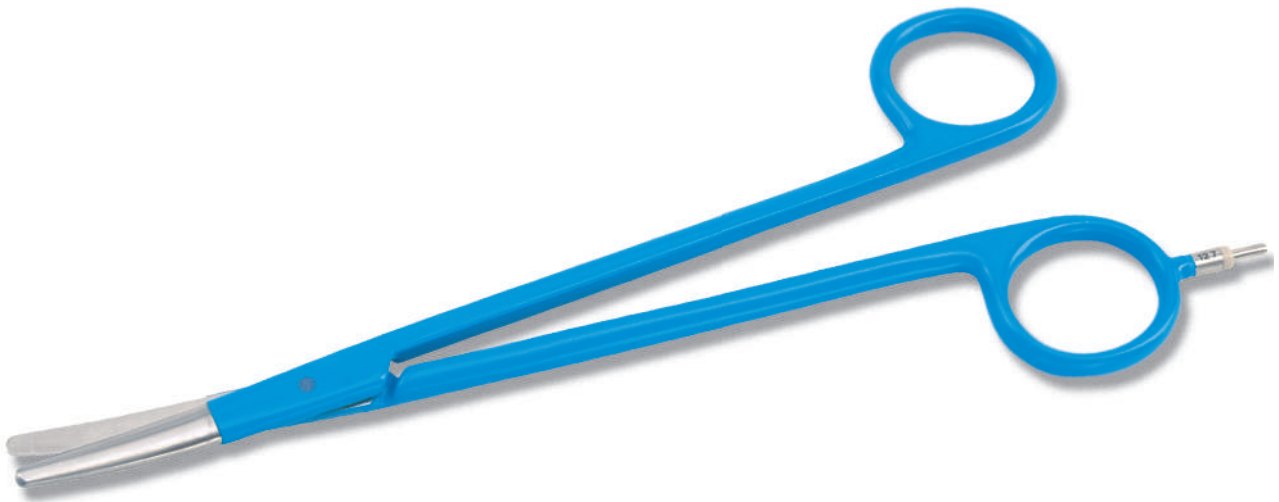

Allgemein

Merkmale unserer bipolaren Scheren:

- Die Stromzufuhr erfolgt über eine Steckverbindung an nur einem Griff der Schere, die Handhabung während des OP's wird dadurch extrem erleichtert.
- RUDOLF Bipolare Scheren ermöglichen das Schneiden und Präparieren bei gleichzeitiger Koagulation.
- Unterschiedliche Arbeitslängen und zwei Versionen (Standard und schlank) erlauben den Einsatz für eine Vielzahl von Anwendungen.
- Die spezielle Konstruktion macht sie besonders reparaturfreundlich.
- Die Scherenschrauben dienen der Stromführung von einem auf das andere Scherenblatt, die Scherenblätter mit Voll-Keramik-Einlage können voneinander getrennt und nachgeschärft werden.

General information

Features of our bipolar scissors:

- *The power is supplied by means of a plug-in construction to one ring only. This simplifies handling during the operation considerably.*
- *RUDOLF bipolar scissors enable cutting and dissection with simultaneous bipolar coagulation.*
- *Various working length and two versions (standard and slim) allow the scissors to be used for a large number of applications.*
- *The special construction ensures that the scissors are easy to repair.*
- *The screws conduct the current from one blade to the other, the blades with a solid ceramic insert can be separated for re-sharpening.*

Bipolare Scheren Bipolar Scissors

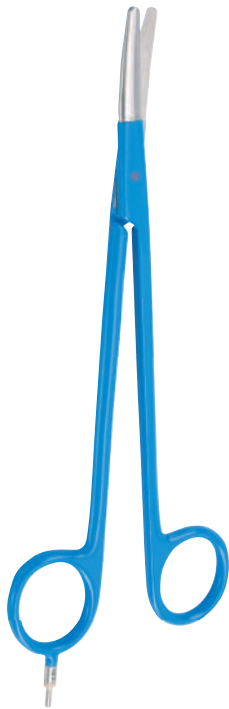



METZENBAUM



Länge Length	gebogen Standard curved Standard	gebogen schlank curved slim
18 cm – 7"	RU 1381-18	RU 1382-18
21 cm – 8¼"	RU 1381-21	RU 1382-21
23 cm – 9"	RU 1381-23	RU 1382-23
28 cm – 11"	RU 1381-28	RU 1382-28

Bipolare Anschlusskabel für abgebildete Scheren
Bipolar connecting cables for illustrated scissors

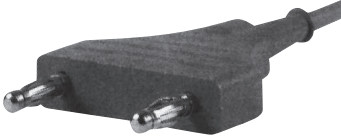
Gerätestecker Plug, generator side	Instrumentenstecker Plug, instrument side	Länge Length	
 Erbe ACC / ICC, Storz		3 m	HF300-202
		5 m	HF300-203
 Martin, Berchtold, Aesculap		3 m	HF300-204
		5 m	HF300-205
 Valleylab, Lamidey, EMC		3 m	HF300-206
		5 m	HF300-207



Allgemein

Merkmale unserer bipolaren Pinzetten:

- Lieferbar mit Flachstecker, auf Anfrage auch mit 2-Pin-Stecker (US-Standard).
- Präzise schließende Arbeitsenden gewährleisten ein sicheres und schonendes Arbeiten.
- Die schlanke und feine Formgebung garantieren ein sicheres Arbeiten auch in besonders delikaten Einsatzbereichen bzw. an schwer zugänglichen Stellen.
- Die breite, geriefte Grifffläche ermöglicht eine sichere Handhabung.
- Die bewährte und äußerst beständige Isolationsbeschichtung gewährleistet die Sicherheit des Instrumentes.
- Unser Kunststoff-Sicherheitsstecker garantiert eine glatte Steckverbindung und damit sicheren elektrischen Kontakt.

NON-STICK Pinzetten:

NON-STICK Pinzetten verhindern das Verkleben des koagulierten Gewebes mit der Pinzettenspitze. Dafür sorgen spezielle polierte Edelmetallspitzen mit einer exzellenten Wärmeleitfähigkeit. Diese Antihafteigenschaften bleiben auch nach einem evtl. Nachpolieren erhalten, da die gesamten Pinzettenspitzen aus Edelmetall hergestellt sind und es sich nicht nur um eine Beschichtung handelt.

General information

Features of our bipolar forceps:

- Available with flat plug, on demand also with 2-pin-plug (US-Standard).
- The precise closing of the jaws ensures safe and gentle working.
- The slim and delicate design grants safe working in extremely delicate areas or in hard-to-reach places.
- The broad, rifeled surface of the handle ensures safe handling.
- The well proven and extremely durable isolation coating grants the safeness of the instrument.
- Our plastic-safety plug grants a smooth plugging and therefore a safe electric contact.

NON-STICK Forceps:

The NON-STICK forceps prevents the sticking of coagulated tissue on the forceps tips. This is possible due to specially polished tips made of precious metal having an excellent heat conductance. These anti-adhesion properties are not lost even after a possible re-polishing, due to the fact that the complete tip of the forceps is made of precious metal and it is not only a coating.

Bipolare Pinzetten

Bipolar Forceps



gerade
straight

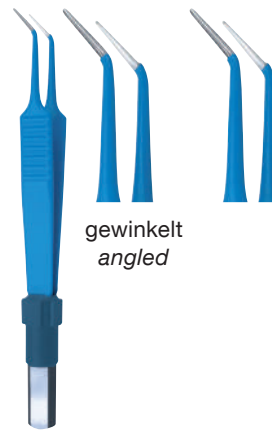

gewinkelt
angled



gebogen
curved

Anschluss Plug	Länge Length	Spitzenbreite Width of tips	Standard	NON-STICK	Standard	NON-STICK	Standard
	11 cm – 4¼"	0,25 mm	HF510-011	HF510-051	HF510-211	HF510-251	HF510-411
		0,60 mm	HF510-111	HF510-151	HF510-311	HF510-351	HF510-511
		1,00 mm	–	HF510-152	–	HF510-352	–

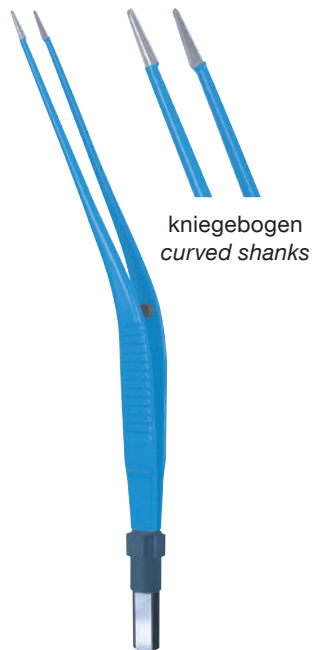

kniegebogen
curved shanks

Anschluss Plug	Länge Length	Spitzenbreite Width of tips	Standard
	17 cm – 6¾"	0,30 mm	HF518-017
		1,00 mm	HF518-117

Passende Bipolare Anschlusskabel auf Seite HF 18.

Suitable bipolar connecting cables on page HF 18.

Bipolare Pinzetten

Bipolar Forceps



gerade
straight



gewinkelt
angled



gebogen
curved

Anschluss Plug	Länge Length	Spitzenbreite Width of tips	Standard	NON-STICK	Standard	NON-STICK	Standard
	12 cm – 4¾"	0,25 mm	HF511-011	HF511-051	HF511-211	HF511-251	HF511-411
		0,80 mm	HF511-111	HF511-151	HF511-311	HF511-351	HF511-511
		1,00 mm	–	HF511-152	–	HF511-352	–

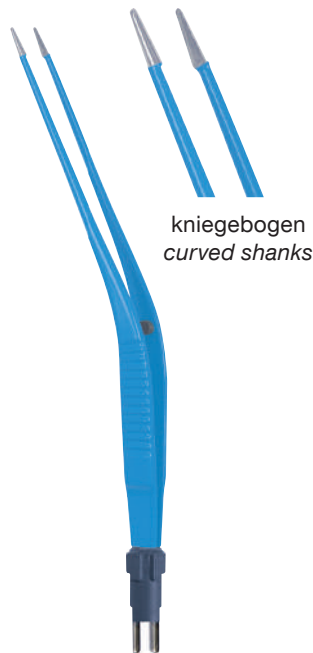



kniegebogen
curved shanks

Anschluss Plug	Länge Length	Spitzenbreite Width of tips	Standard
	17 cm – 6¾"	0,30 mm	HF519-017
		1,00 mm	HF519-117

2-Pin-Stecker (US-Standard).
Passende Bipolare Anschlusskabel auf Seite HF 18.

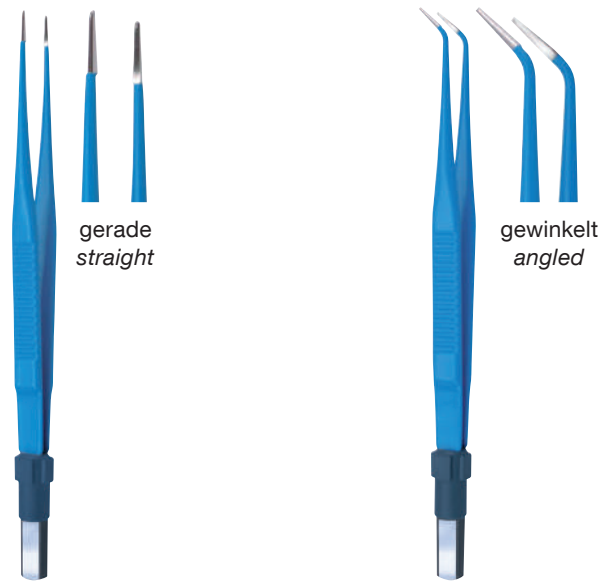
2-pin-plug (US-Standard).
Suitable bipolar connecting cables on page HF 18.



Anschluss Plug	Länge Length	Spitzenbreite Width of tips	Standard	NON-STICK	Standard	NON-STICK
	15 cm – 6"	0,30 mm	HF515-015	HF515-055	HF515-515	HF515-555
		0,60 mm	–	HF515-056	–	–
		1,00 mm	HF515-115	HF515-155	HF515-615	HF515-655
		2,00 mm	–	HF515-156	–	HF515-656
	18 cm – 7"	0,30 mm	HF515-018	HF515-058	HF515-518	HF515-558
		0,60 mm	–	HF515-059	–	–
		1,00 mm	HF515-118	HF515-158	HF515-618	HF515-658
		2,00 mm	–	HF515-159	–	HF515-659
	20 cm – 8"	0,30 mm	HF515-020	HF515-070	HF515-520	–
		1,00 mm	HF515-120	HF515-170	HF515-620	–
		2,00 mm	–	HF515-171	–	–
	22 cm – 8¾"	0,30 mm	HF515-022	HF515-072	HF515-522	–
		1,00 mm	HF515-122	HF515-172	HF515-622	–
		2,00 mm	–	HF515-173	–	–
24 cm – 9½"	0,30 mm	HF515-024	–	HF515-524	–	
	1,00 mm	HF515-124	–	HF515-624	–	

Passende Bipolare Anschlusskabel auf Seite HF 18.

Suitable bipolar connecting cables on page HF 18.



Anschluss Plug	Länge Length	Spitzenbreite Width of tips	Standard	NON-STICK	Standard	NON-STICK
	15 cm – 6"	0,30 mm	HF516-015	HF516-055	HF516-515	HF516-555
		0,60 mm	–	HF516-056	–	–
		1,00 mm	HF516-115	HF516-155	HF516-615	HF516-655
		2,00 mm	–	HF516-156	–	HF516-656
	18 cm – 7"	0,30 mm	HF516-018	HF516-058	HF516-518	HF516-558
		0,60 mm	–	HF516-059	–	–
		1,00 mm	HF516-118	HF516-158	HF516-618	HF516-658
		2,00 mm	–	HF516-159	–	HF516-659
	20 cm – 8"	0,30 mm	HF516-020	HF516-070	HF516-520	–
		1,00 mm	HF516-120	HF516-170	HF516-620	–
		2,00 mm	–	HF516-171	–	–
	22 cm – 8¾"	0,30 mm	HF516-022	HF516-072	HF516-522	–
		1,00 mm	HF516-122	HF516-172	HF516-622	–
		2,00 mm	–	HF516-173	–	–
24 cm – 9½"	0,30 mm	HF516-024	–	HF516-524	–	
	1,00 mm	HF516-124	–	HF516-624	–	

2-Pin-Stecker (US-Standard).
Passende Bipolare Anschlusskabel auf Seite HF 18.

2-pin-plug (US-Standard).
Suitable bipolar connecting cables on page HF 18.

Bipolare Pinzetten

Bipolar Forceps

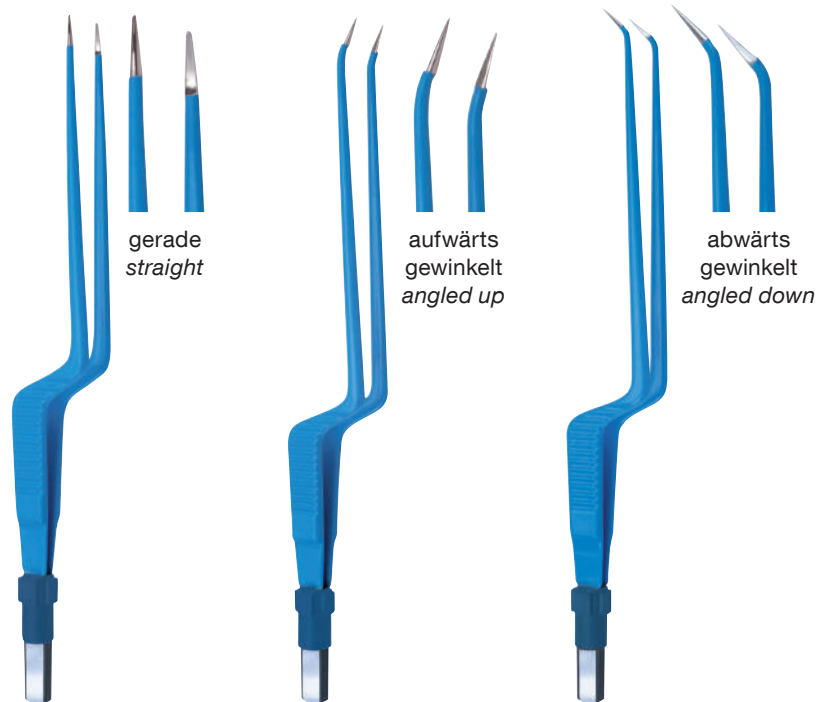

Anschluss Plug	Länge Length	Spitzenbreite Width of tips	Standard	NON-STICK	Standard	NON-STICK	Standard	NON-STICK
	16,5 cm – 6½"	0,60 mm	HF520-017	–	–	–	–	–
	18 cm – 7"	0,30 mm	HF520-018	HF520-058	HF520-418	–	HF520-818	–
		0,60 mm	–	HF520-059	–	–	–	–
		1,00 mm	HF520-118	HF520-158	HF520-518	–	HF520-918	–
		2,00 mm	–	HF520-159	–	–	–	–
	20 cm – 8"	0,30 mm	HF520-020	HF520-070	HF520-420	–	HF520-820	–
		0,60 mm	–	HF520-071	–	–	–	–
		1,00 mm	HF520-120	HF520-170	HF520-520	HF520-570	HF520-920	HF520-970
		2,00 mm	–	HF520-171	–	–	–	–
	22 cm – 8¾"	0,30 mm	HF520-022	HF520-072	HF520-422	–	HF520-822	–
		0,60 mm	–	HF520-073	–	–	–	–
		1,00 mm	HF520-122	HF520-172	HF520-522	HF520-572	HF520-922	HF520-972
		2,00 mm	–	HF520-173	–	–	–	–
	24 cm – 9½"	0,30 mm	HF520-024	HF520-074	HF520-424	–	HF520-824	–
		0,60 mm	–	HF520-075	–	–	–	–
		1,00 mm	HF520-124	HF520-174	HF520-524	–	HF520-924	–
		2,00 mm	–	HF520-175	–	–	–	–

Passende Bipolare Anschlusskabel auf Seite HF 18.

Suitable bipolar connecting cables on page HF 18.

Bipolare Pinzetten

Bipolar Forceps



Anschluss Plug	Länge Length	Spitzenbreite Width of tips	Standard	NON-STICK	Standard	NON-STICK	Standard	NON-STICK
	18 cm – 7"	0,30 mm	HF521-018	HF521-058	HF521-418	–	HF521-818	–
		0,60 mm	–	HF521-059	–	–	–	–
		1,00 mm	HF521-118	HF521-158	HF521-518	–	HF521-918	–
		2,00 mm	–	HF521-159	–	–	–	–
	20 cm – 8"	0,30 mm	HF521-020	HF521-070	HF521-420	–	HF521-820	–
		0,60 mm	–	HF521-071	–	–	–	–
		1,00 mm	HF521-120	HF521-170	HF521-520	HF521-570	HF521-920	HF521-970
		2,00 mm	–	HF521-171	–	–	–	–
	22 cm – 8¾"	0,30 mm	HF521-022	HF521-072	HF521-422	–	HF521-822	–
		0,60 mm	–	HF521-073	–	–	–	–
		1,00 mm	HF521-122	HF521-172	HF521-522	HF521-572	HF521-922	HF521-972
		2,00 mm	–	HF521-173	–	–	–	–
	24 cm – 9½"	0,30 mm	HF521-024	HF521-074	HF521-424	–	HF521-824	–
		0,60 mm	–	HF521-075	–	–	–	–
		1,00 mm	HF521-124	HF521-174	HF521-524	–	HF521-924	–
		2,00 mm	–	HF521-175	–	–	–	–

2-Pin-Stecker (US-Standard).
Passende Bipolare Anschlusskabel auf Seite HF 18.

2-pin-plug (US-Standard).
Suitable bipolar connecting cables on page HF 18.

Bipolare Pinzetten

Bipolar Forceps

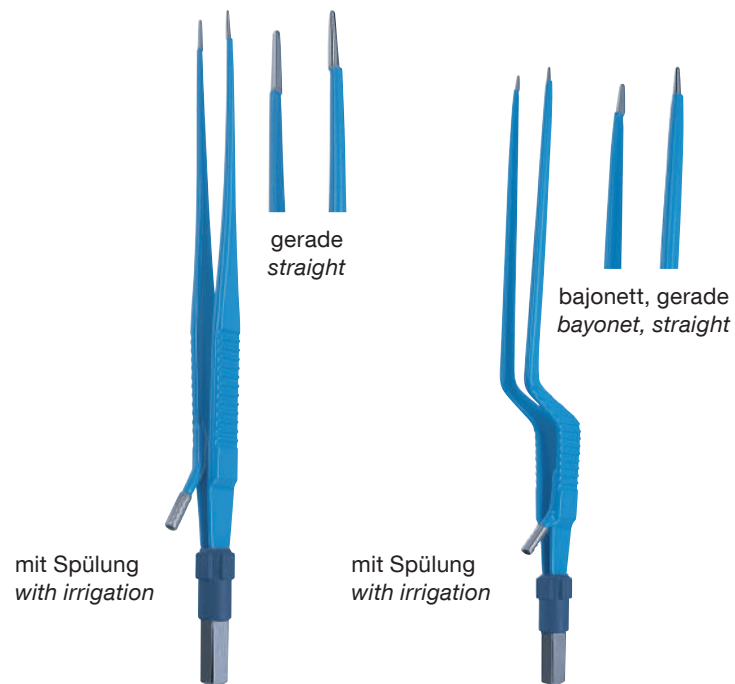

Anschluss Plug	Länge Length	Spitzenbreite Width of tips	Standard	Spitzenbreite Width of tips	Standard
	18cm – 7"	0,5 x 8 mm	HF530-018	0,5 x 8 mm	HF532-018
		1,0 x 8 mm	HF530-118	1,0 x 8 mm	HF532-118
		2,0 x 8 mm	HF530-218	1,5 x 8 mm	HF532-218
	20 cm – 8"	0,5 x 8 mm	HF530-020	0,5 x 8 mm	HF532-020
		1,0 x 8 mm	HF530-120	1,0 x 8 mm	HF532-120
		2,0 x 8 mm	HF530-220	1,5 x 8 mm	HF532-220
	22 cm – 8¾"	0,5 x 8 mm	HF530-022	0,5 x 8 mm	HF532-022
		1,0 x 8 mm	HF530-122	1,0 x 8 mm	HF532-122
		2,0 x 8 mm	HF530-222	1,5 x 8 mm	HF532-222
	24 cm – 9½"	–	–	0,5 x 8 mm	HF532-024
		–	–	1,0 x 8 mm	HF532-124
		–	–	1,5 x 8 mm	HF532-224

Passende Bipolare Anschlusskabel auf Seite HF 18.

Suitable bipolar connecting cables on page HF 18.

Bipolare Pinzetten

Bipolar Forceps

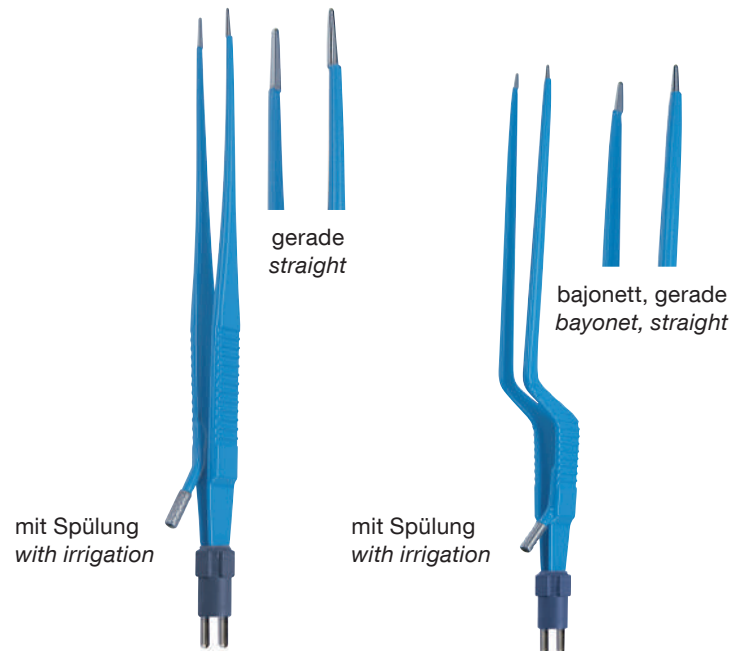

Anschluss Plug	Länge Length	Spitzenbreite Width of tips	Standard	Spitzenbreite Width of tips	Standard
	18 cm – 7"	0,5 x 8 mm	HF531-018	0,5 x 8 mm	HF533-018
		1,0 x 8 mm	HF531-118	1,0 x 8 mm	HF533-118
		2,0 x 8 mm	HF531-218	1,5 x 8 mm	HF533-218
	20 cm – 8"	0,5 x 8 mm	HF531-020	0,5 x 8 mm	HF533-020
		1,0 x 8 mm	HF531-120	1,0 x 8 mm	HF533-120
		2,0 x 8 mm	HF531-220	1,5 x 8 mm	HF533-220
	22 cm – 8¾"	0,5 x 8 mm	HF531-022	0,5 x 8 mm	HF533-022
		1,0 x 8 mm	HF531-122	1,0 x 8 mm	HF533-122
		2,0 x 8 mm	HF531-222	1,5 x 8 mm	HF533-222
	24 cm – 9½"	–	–	0,5 x 8 mm	HF533-024
		–	–	1,0 x 8 mm	HF533-124
		–	–	1,5 x 8 mm	HF533-224

2-Pin-Stecker (US-Standard).
Passende Bipolare Anschlusskabel auf Seite HF 18.

2-pin-plug (US-Standard).
Suitable bipolar connecting cables on page HF 18.

Bipolare Pinzetten

Bipolar Forceps

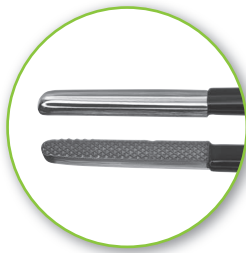

TC
Hartmetall
Tungsten Carbide

Allgemein

Merkmale unserer bipolaren Pinzetten, isoliert, mit **TC**-Einlage:

- Sicheres Fassen
- Praktisch kein Anhaften von Gewebe
- Sehr guter Gefäßverschluss

General information

Features of our bipolar forceps, insulated, with **TC** insert:

- Safe grasping
- Virtually no tissue sticking
- Excellent vessel closure

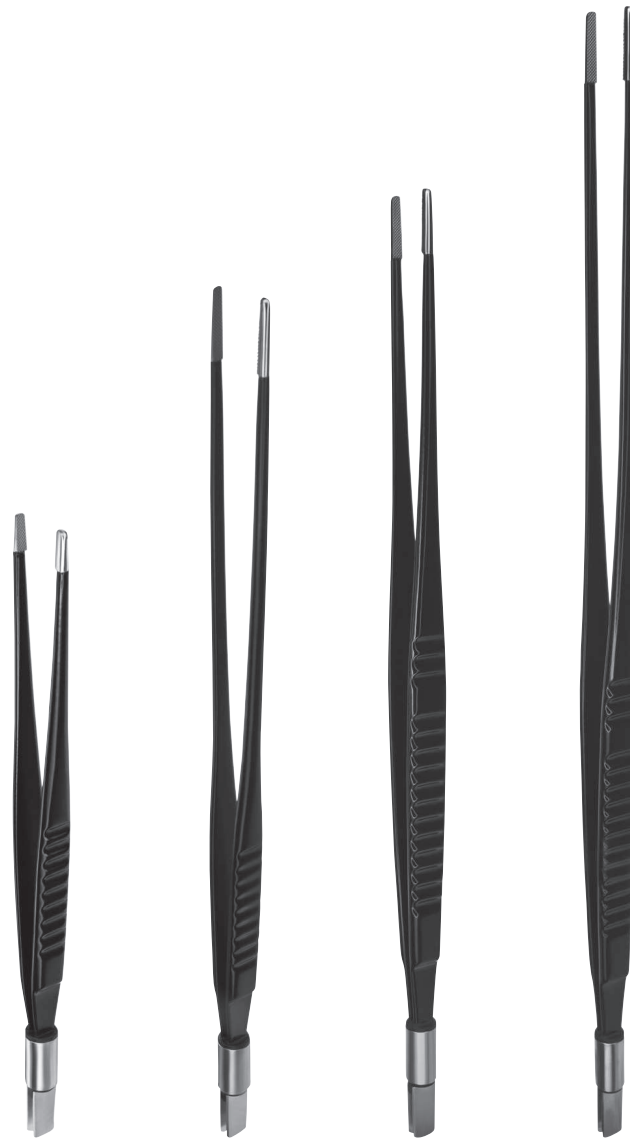

Anschluss Plug	Spitzenbreite Width of tips	16,5 cm – 6½"	22 cm – 8¾"	25 cm – 10"	30 cm – 11¼"
	2,2 mm	RU 4302-46	RU 4302-52	RU 4302-55	RU 4302-57

Passende Bipolare Anschlusskabel auf Seite HF 18.

Suitable bipolar connecting cables on page HF 18.

Bipolare Pinzetten

Bipolar Forceps



TC
Hartmetall
Tungsten Carbide

Allgemein

Merkmale unserer bipolaren Pinzetten, isoliert, mit **TC**-Einlage:

- Sicheres Fassen
- Praktisch kein Anhaften von Gewebe
- Sehr guter Gefäßverschluss

General information

Features of our bipolar forceps, insulated, with **TC** insert:

- Safe grasping
- Virtually no tissue sticking
- Excellent vessel closure



Anschluss Plug	Spitzenbreite Width of tips	19 cm – 7½"	19 cm – 7½"
	2,2 mm	RU 4302-76	RU 4302-82

Passende Bipolare Anschlusskabel auf Seite HF 18.

Suitable bipolar connecting cables on page HF 18.

Bipolare Anschlusskabel Bipolar Connecting Cables





für bipolare Pinzetten
for bipolar forceps

Flachstecker
Flat plug

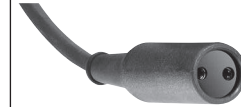

2-Pin Stecker US-Standard
2-pin plug US-Standard

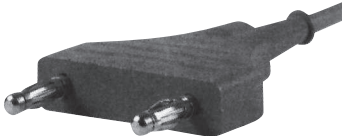

Gerätestecker Plug, generator side	Länge Length		Länge Length	
 Valleylab, Birtcher, Conmed, Bovie	3 m	HF310-103	4 m	HF310-3031
	5 m	HF310-105	-	-
 Erbe ACC / ICC, Storz	3 m	HF310-113	3 m	HF310-313
	5 m	HF310-115	5 m	HF310-315
 Martin, Berchtold, Aesculap	3 m	HF310-123	3 m	HF310-323
	5 m	HF310-125	5 m	HF310-325
 Valleylab, Lamidey, EMC	3 m	HF310-133	3 m	HF310-333
	5 m	HF310-135	5 m	HF310-335



Sterilisierzangen	<i>Sterilization Forceps</i>	HS 1
Dreieckschalen und Stechbecken	<i>Triangular Bowls and Bed Pans</i>	HS 2
Messbecher und Nierenschalen	<i>Measuring Jugs and Kidney Bowls</i>	HS 3
Behälter, rund	<i>Bowls, Round</i>	HS 4 - 6
Instrumentenschalen	<i>Instrument Trays</i>	HS 7 - 8
Siebkörbe, Größe 1/2	<i>Baskets, Half Size</i>	HS 9
Siebkörbe, Größe 3/4	<i>Baskets, Three-Quarter Size</i>	HS 10
Siebkörbe, Größe 1/1	<i>Baskets, Full Size</i>	HS 11
Siebkörbe, Größe Mini	<i>Baskets, Mini Size</i>	HS 12 - 13
Zubehör	<i>Accessories</i>	HS 14 - 15
Bereitstellungstische, Regalwagen	<i>Trolleys</i>	HS 16 - 17

Sterilisierzangen Sterilization Forceps

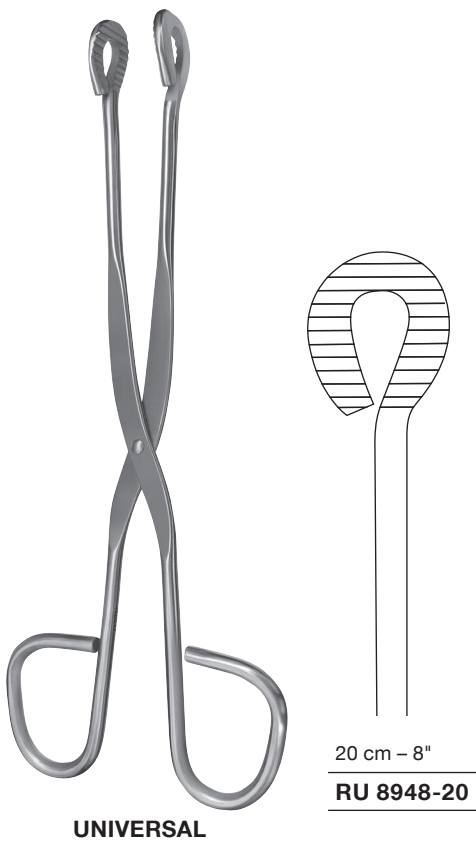
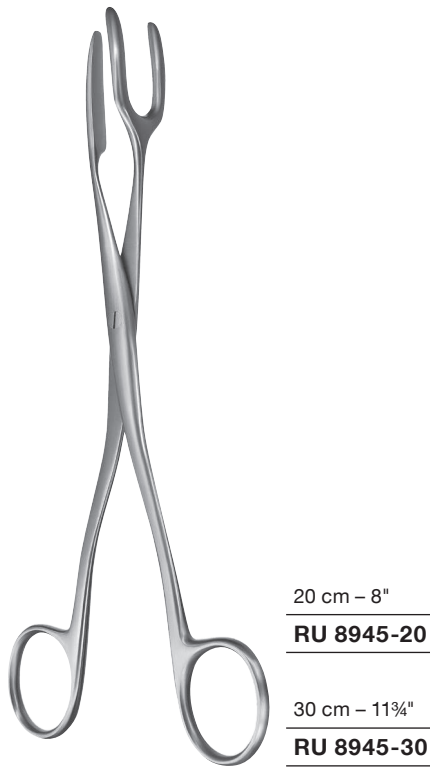

Sterilisierklammern Sterilization clamps

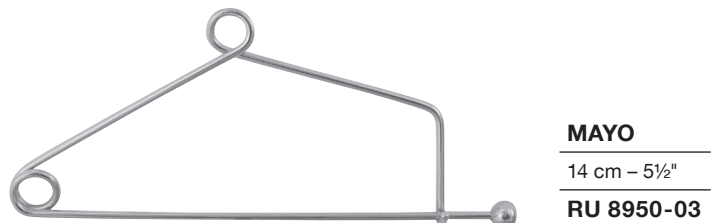
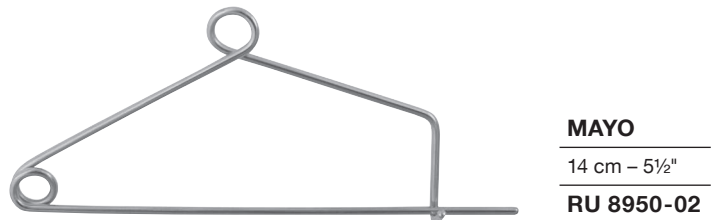

Dreieckschalen und Stechbecken
 Triangular Bowls and Bed Pans

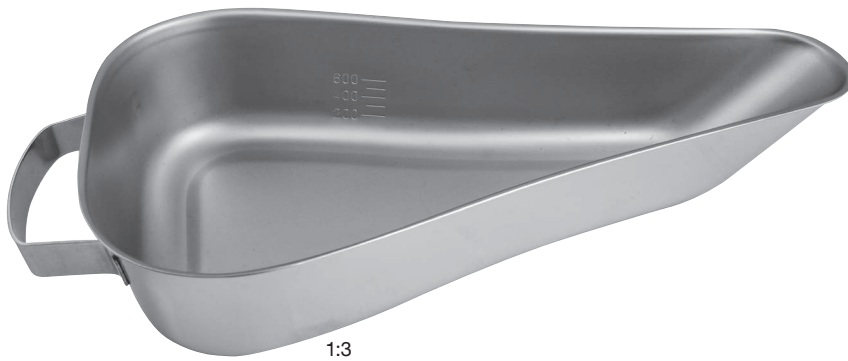

1:3

Dreieckschale mit Griff
 Triangular bowl with handle

RU 8960-01

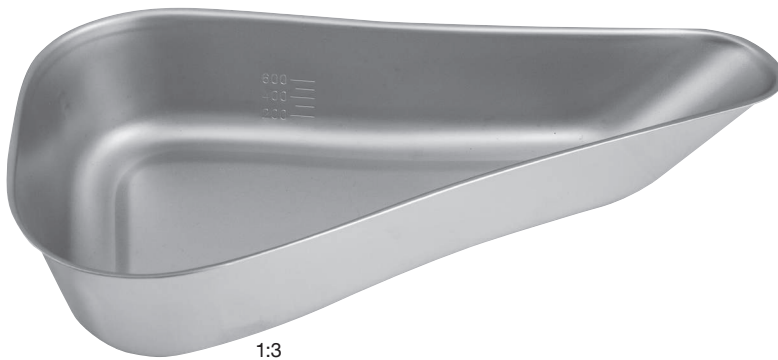

1:3

Dreieckschale
 Triangular bowl

RU 8960-02



1:6

Stechbecken, amerikanische Form
 Bed pan (American pattern)

350 x 290 x 90,5 mm

RU 8960-05



1:3

Stechbecken
 Bed pan

230 x 70 mm	310 x 82 mm
-------------	-------------

RU 8961-01	RU 8961-02
-------------------	-------------------

Messbecher und Nierenschalen

Measuring Jugs and Kidney Bowls



	Messbecher <i>Measuring jugs</i>
0,25 l	RU 8964-02
0,50 l	RU 8964-05
1,00 l	RU 8964-10
1,50 l	RU 8964-15
2,00 l	RU 8964-20



		Nierenschalen <i>Kidney bowls</i>
0,25 l	170 x 36 mm	RU 8970-01
0,50 l	250 x 32 mm	RU 8970-02
0,75 l	275 x 45 mm	RU 8970-03

Runde Behälter
Round Bowls



	Wattespender <i>Cotton dispensers</i>
85 x 85 mm	RU 8972-01
100 x 100 mm	RU 8972-02
120 x 120 mm	RU 8972-03
150 x 150 mm	RU 8972-04



	Medizinbecher <i>Medicine cups</i>
25 cc	RU 8975-05
50 cc	RU 8975-10



	Medizinbecher <i>Medicine cups</i>
100 cc = 0,10 l	RU 8975-10/10
250 cc = 0,25 l	RU 8975-10/25



1:3

	Sputumbecher <i>Sputum cup</i>
85 x 85 mm	
	RU 8976-20

Runde Behälter Round Bowls



Ø x H Ø x h	Standgefäße Jars
30 x 80 mm	RU 8984-01
35 x 100 mm	RU 8984-02
50 x 120 mm	RU 8984-03
60 x 130 mm	RU 8984-04
75 x 140 mm	RU 8984-05
75 x 175 mm	RU 8984-06
100 x 150 mm	RU 8984-07



Ø x H Ø x h	Liter Litre	Schalen Bowls
40 x 19 mm	0,05 l	RU 8985-10
61 x 30 mm	0,07 l	RU 8985-11
80 x 40 mm	0,14 l	RU 8985-01
116 x 50 mm	0,35 l	RU 8985-02
128 x 55 mm	0,45 l	RU 8985-03
147 x 65 mm	0,70 l	RU 8985-04
167 x 75 mm	1,10 l	RU 8985-05
187 x 85 mm	1,60 l	RU 8985-06

Runde Behälter

Round Bowls



Ø x H Ø x h	Schalen Bowls
120 x 35 mm	RU 8986-12
140 x 35 mm	RU 8986-14
160 x 35 mm	RU 8986-16



Typ Type	Ø x H Ø x h	Liter Litre	Schalen Bowls
B1	40 x 19 mm	0,02 l	RU 8987-01
B2	61 x 30 mm	0,06 l	RU 8987-02
B4	83 x 41 mm	0,16 l	RU 8987-03
B6	111 x 56 mm	0,40 l	RU 8987-04
B8	151 x 73 mm	1,00 l	RU 8987-05
B10	211 x 76 mm	2,50 l	RU 8987-06



Ø x H Ø x h	Liter Litre	Schalen Bowls
165 x 55 mm	0,75 l	RU 8988-01
175 x 70 mm	1,00 l	RU 8988-02
225 x 100 mm	2,00 l	RU 8988-03
240 x 90 mm	2,75 l	RU 8988-04
260 x 120 mm	4,00 l	RU 8988-05
315 x 105 mm	5,50 l	RU 8988-06
325 x 135 mm	8,00 l	RU 8988-07
380 x 130 mm	11,00 l	RU 8988-08
405 x 150 mm	14,00 l	RU 8988-09

Instrumentenschalen Instrument Trays



1:3

Instrumentenablageplatten *Instrument storage trays*

160 x 210 x 10 mm	RU 8977-01
240 x 180 x 10 mm	RU 8977-02
280 x 210 x 10 mm	RU 8977-03
300 x 160 x 10 mm	RU 8977-04
310 x 210 x 10 mm	RU 8977-05
400 x 270 x 10 mm	RU 8977-06



1:4

L x B x H
l x b x h

Schalen
Trays

330 x 230 x 30 mm	RU 8978-01
350 x 250 x 30 mm	RU 8978-02
350 x 250 x 50 mm	RU 8978-04



1:3

Instrumentenkasten *Instrument box*

205 x 105 x 40 mm

RU 8979-00

Instrumentenschalen Instrument Trays



1:3

L x B x H <i>l x b x h</i>	Instrumentenkasten <i>Instrument box</i>
165 x 90 x 35 mm	RU 8980-01
200 x 100 x 50 mm	RU 8980-02
220 x 150 x 50 mm	RU 8980-03
260 x 150 x 50 mm	RU 8980-04
305 x 205 x 50 mm	RU 8980-05
420 x 80 x 40 mm	RU 8980-06



1:3

Schalen *Trays*

235 x 190 x 40 mm

RU 8989-00

Siebkörbe, Größe 1/2

Baskets, Half Size



Deckel für Drahtsiebkorb
Lid for wire basket

240 x 215 mm **CS140-000**

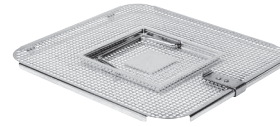

Deckel für Siebkorb
Lid for perforated basket

240 x 240 mm **CS141-000**



Drahtsiebkorb
Wire basket

255 x 245 x 30 mm **CS140-030**

255 x 245 x 50 mm **CS140-050**

255 x 245 x 70 mm **CS140-070**

255 x 245 x 100 mm **CS140-100**



Siebkorb
Perforated basket

240 x 240 x 41 mm **CS141-041**

240 x 240 x 45 mm **CS141-045**

240 x 240 x 50 mm **CS141-050**

240 x 240 x 70 mm **CS141-070**

240 x 240 x 90 mm **CS141-090**

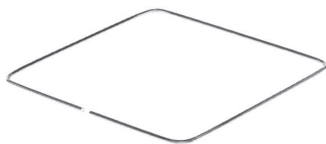

Spannrahmen für Drahtsiebkorb
Drape retainer for wire basket

255 x 255 mm **CS146-000**



Silikon-Noppenmatte für
Drahtsiebkorb und Siebkorb
Silicone stud mat for baskets

240 x 220 mm **CS147-001**

Siebkörbe, Größe 3/4 Baskets, Three-Quarter Size

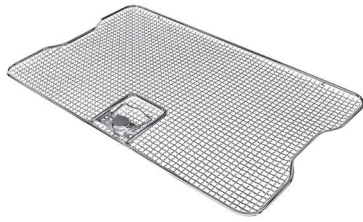

Deckel für Drahtsiebkorb
Lid for wire basket

375 x 240 mm **CS240-000**



Deckel für Siebkorb
Lid for perforated basket

380 x 240 mm **CS241-000**

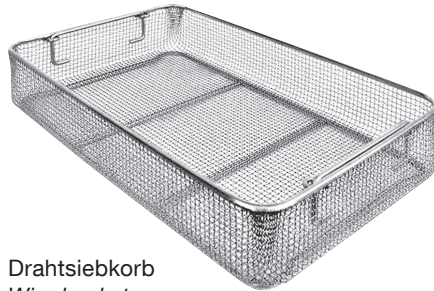

Drahtsiebkorb
Wire basket

405 x 255 x 30 mm **CS240-030**

405 x 255 x 50 mm **CS240-050**

405 x 255 x 70 mm **CS240-070**

405 x 255 x 100 mm **CS240-100**



Siebkorb
Perforated basket

380 x 240 x 41 mm **CS241-041**

380 x 240 x 45 mm **CS241-045**

380 x 240 x 50 mm **CS241-050**

380 x 240 x 70 mm **CS241-070**

380 x 240 x 90 mm **CS241-090**



Spannrahmen für Drahtsiebkorb
Drape retainer for wire basket

405 x 255 mm **CS246-000**



Silikon-Noppenmatte für
Drahtsiebkorb und Siebkorb
*Silicone stud mat for
wire basket and perforated basket*

380 x 220 mm **CS247-000**

Siebkörbe, Größe 1/1

Baskets, Full Size

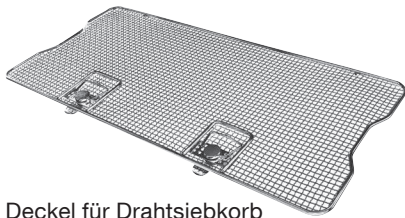

Deckel für Drahtsiebkorb
Lid for wire basket

455 x 240 mm **CS340-000**

510 x 240 mm **CS341-000**

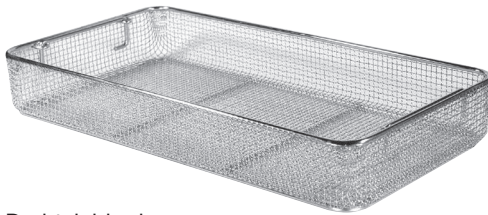

Drahtsiebkorb
Wire basket

485 x 255 x 30 mm **CS340-030**

485 x 255 x 50 mm **CS340-050**

485 x 255 x 70 mm **CS340-070**

485 x 255 x 100 mm **CS340-100**

540 x 255 x 30 mm **CS341-030**

540 x 255 x 50 mm **CS341-050**

540 x 255 x 70 mm **CS341-070**

540 x 255 x 100 mm **CS341-100**



Silikon-Noppenmatte für
Drahtsiebkorb und Siebkorb
*Silicone stud mat for
wire basket and perforated basket*

480 x 220 mm **CS347-000**

500 x 220 mm **CS348-000**



Deckel für Siebkorb
Lid for perforated basket

480 x 240 mm **CS342-000**

510 x 240 mm **CS343-000**

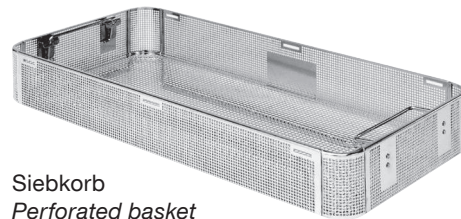

Siebkorb
Perforated basket

480 x 240 x 41 mm **CS342-041**

480 x 240 x 45 mm **CS342-045**

480 x 240 x 50 mm **CS342-050**

480 x 240 x 70 mm **CS342-070**

480 x 240 x 90 mm **CS342-090**

540 x 240 x 41 mm **CS343-041**

540 x 240 x 45 mm **CS343-045**

540 x 240 x 50 mm **CS343-050**

540 x 240 x 70 mm **CS343-070**

540 x 240 x 90 mm **CS343-090**

540 x 240 x 70 mm **CS343-180**



Spannrahmen für Drahtsiebkorb
Drape retainer for wire basket

545 x 255 mm **CS346-000**

Siebkörbe, Größe Mini Baskets, Mini Size



Drahtsiebkorb
Wire basket

265 x 120 x 45 mm **CS540-045**



Spannrahmen für Drahtsiebkorb
Drape retainer for wire basket

300 x 140 mm **CS546-000**



Silikon-Noppenmatte für
Drahtsiebkorb und Siebkorb
*Silicone stud mat for
wire basket and perforated basket*

240 x 110 mm **CS547-000**

Siebkörbe, Größe Mini Baskets, Mini Size



Minikorb mit Deckel
Mini basket with lid

- 1 Instrumentenhalter im Deckel
- 2 Instrumentenhalter im Körper
- 1 Instrument holder in the lid*
- 2 Instrument holders in the basket*

170 x 50 x 30 mm **CS050-001**



Minikorb mit Deckel
Mini basket with lid

- 2 Instrumentenhalter im Deckel
- Silikon-Noppenmatte im Körper
- 2 Instrument holders in the lid*
- Silicone mat in the basket*

170 x 50 x 30 mm **CS050-002**

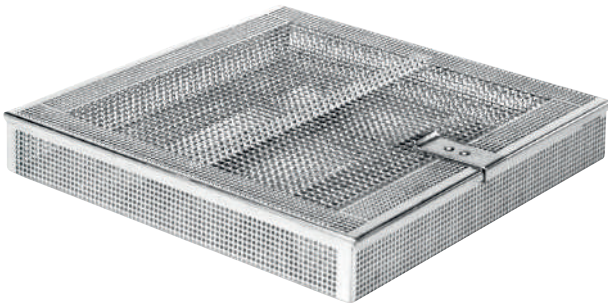

Minikorb mit Deckel
Mini basket with lid

- 1 Instrumentenhalter im Deckel
- 2 Instrumentenhalter im Körper
- 1 Instrument holder in the lid*
- 2 Instrument holders in the basket*

240 x 240 x 35 mm **CS050-005**

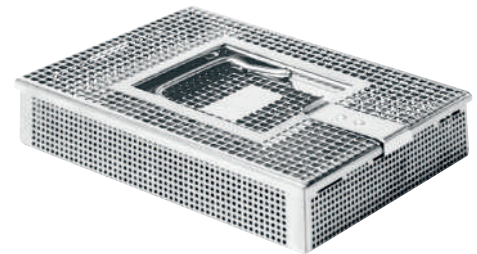

Minikorb mit Deckel
Mini basket with lid

- 1 Instrumentenhalter im Deckel
- Silikon-Noppenmatte im Körper
- 1 Instrument holder in the lid*
- Silicone mat in the basket*

135 x 170 x 35 mm **CS050-003**

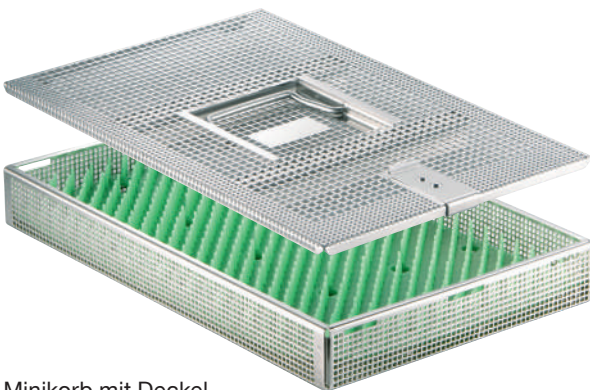

Minikorb mit Deckel
Mini basket with lid

- 2 Instrumentenhalter im Deckel
- Silikon-Noppenmatte im Körper
- 2 Instrument holders in the lid*
- Silicone mat in the basket*

270 x 170 x 35 mm **CS050-004**

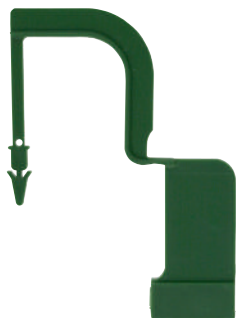

Verschlussplombe
Seal

1000 Stück / Packung
1000 pieces / package

CS950-028



Entsorgungsmarke
für Drahtsiebkörbe
*Metal label for
wire basket*

unbeschriftet
unlabeled

CS961-020



Entsorgungsmarke
für Drahtsiebkörbe
*Metal label for
wire basket*

beschriftet
labeled

CS961-021



Karabinerhaken
Carabiner

RU 8906-01



Edelstahlplakette
Ø 20 mm
*Stainless steel tag
Ø 20 mm*

CS961-030



Sortierspieß
Holding pin

CS956-001



Trennblechhaltestift
Partition holding pin

CS956-002



Trennblech
Partition sheet

50 x 20 mm **CS956-010**

130 x 20 mm **CS956-011**

225 x 20 mm **CS956-012**

460 x 20 mm **CS956-013**



Fixierklammer
Fixation clamp

24 x 28 x 25 mm Ø 7 x 12 mm **CS961-011**

24 x 28 x 29 mm Ø 12 x 16 mm **CS961-012**

24 x 28 x 31 mm Ø 16 x 26 mm **CS961-013**

24 x 28 x 40 mm Ø 26 x 36 mm **CS961-014**

24 x 28 x 44 mm Ø 36 x 45 mm **CS961-015**



Tuchklammer
Drape clamp

CS961-010



Doppelte Spiralfeder
Double spiral holder

CS956-021



Spiralfeder
Spiral holder

CS956-020



Einschlagtuch aus Baumwolle
Wrapping drape, cotton

60 x 40 cm **RU 8906-31**

90 x 40 cm **RU 8906-32**

130 x 40 cm **RU 8906-33**

85 x 85 cm **RU 8906-34**

130 x 85 cm **RU 8906-35**

160 x 80 cm **RU 8906-36**

160 x 100 cm **RU 8906-37**

160 x 160 cm **RU 8906-38**

240 x 160 cm **RU 8906-39**



Sterilgut-Bereitstellungstisch, mobil,
für 1 großen Container
Tischplatte 660 x 400 mm
Gesamthöhe 850 mm
- Lagerungsschienen für Deckelablage
- 1 Regalboden
- Rollen mit Feststellbremse

*Sterile good table, mobile,
for 1 full size container
table surface 660 x 400 mm
total height 850 mm*

- deposit rails for container lid
- 1 shelf
- wheels with fixing brake

CS980-010



Sterilgut-Bereitstellungstisch, mobil,
für 2 große Container
Tischplatte 660 x 640 mm
Gesamthöhe 850 mm
- Lagerungsschienen für Deckelablage
- 1 Regalboden
- Rollen mit Feststellbremse

*Sterile good table, mobile,
for 2 full size containers
table surface 660 x 640 mm
total height 850 mm*

- deposit rails for container lids
- 1 shelf
- wheels with fixing brake

CS980-011



Sterilgut-Regalwagen, offen
1165 x 700 mm (L x B)
Gesamthöhe 1310 mm
- 4 Regalböden
- Rollen mit Feststellbremse

*Sterile good transport trolley, open
1165 x 700 mm (l x w)
total height 1310 mm
- 4 shelves
- wheels with fixing brake*

CS980-012



Sterilgut-Regalwagen, geschlossen
1190 x 720 mm (L x B)
Gesamthöhe 1465 mm
- 2 Regalböden
- Rollen mit Feststellbremse

*Sterile good transport trolley, closed
1190 x 720 mm (l x w)
total height 1465 mm
- 2 shelves
- wheels with fixing brake*

CS980-013





RUDOLF Medical GmbH + Co. KG, weltweit vertreten, vertraut auf bleibende Werte und setzt diese durch enge Kundenbeziehungen um. **RUDOLF** Medical bietet innovative Hightech-Produkte, Handinstrumente, starre Endoskope sowie effiziente Serviceleistungen für zahlreiche chirurgische Fachgebiete an.

RUDOLF Medical GmbH + Co. KG, represented worldwide, translates its belief in lasting values by fostering close customer relationships and offering innovative high technology products, hand instruments, rigid endoscopes as well as efficient services for numerous surgical disciplines.



Vertrieb durch:
Distributed by:

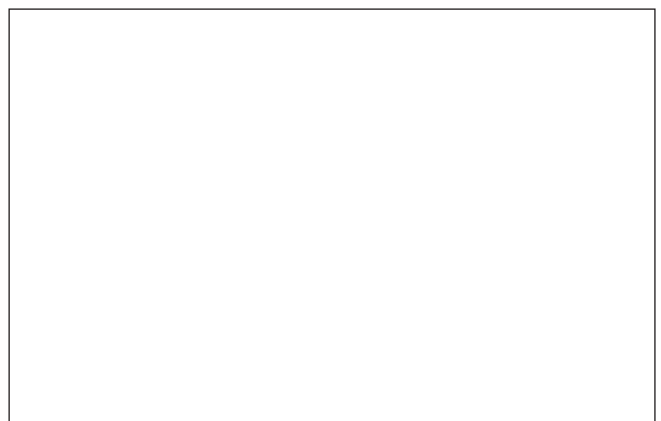

Vertrieb durch: RUDOLF Medical GmbH + Co. KG
Zollerstr. 1, 78567 Fridingen, Germany
Tel.: +49 7463 9956-0
sales@rudolf-med.com
www.rudolf-med.com
BECAUSE WE CARE



ZK 300 DE/EN_Rev. 04.2021

